

## EMILY-RS

~8° spot beam. 14.74 mm high lens.

### TECHNICAL SPECIFICATIONS:

Dimensions	Ø 26 mm
Height	14.7 mm
Fastening	tape
Colour	clear
Box size	480 x 280 x 300 mm
Box weight	10.3 kg
Quantity in Box	1690 pcs
ROHS compliant	yes ⓘ



### MATERIAL SPECIFICATIONS:

Component	Type	Material	Colour
EMILY-RS	Lens	PMMA	clear
SPUTNIK-TAPE	Tape	PU tape	black

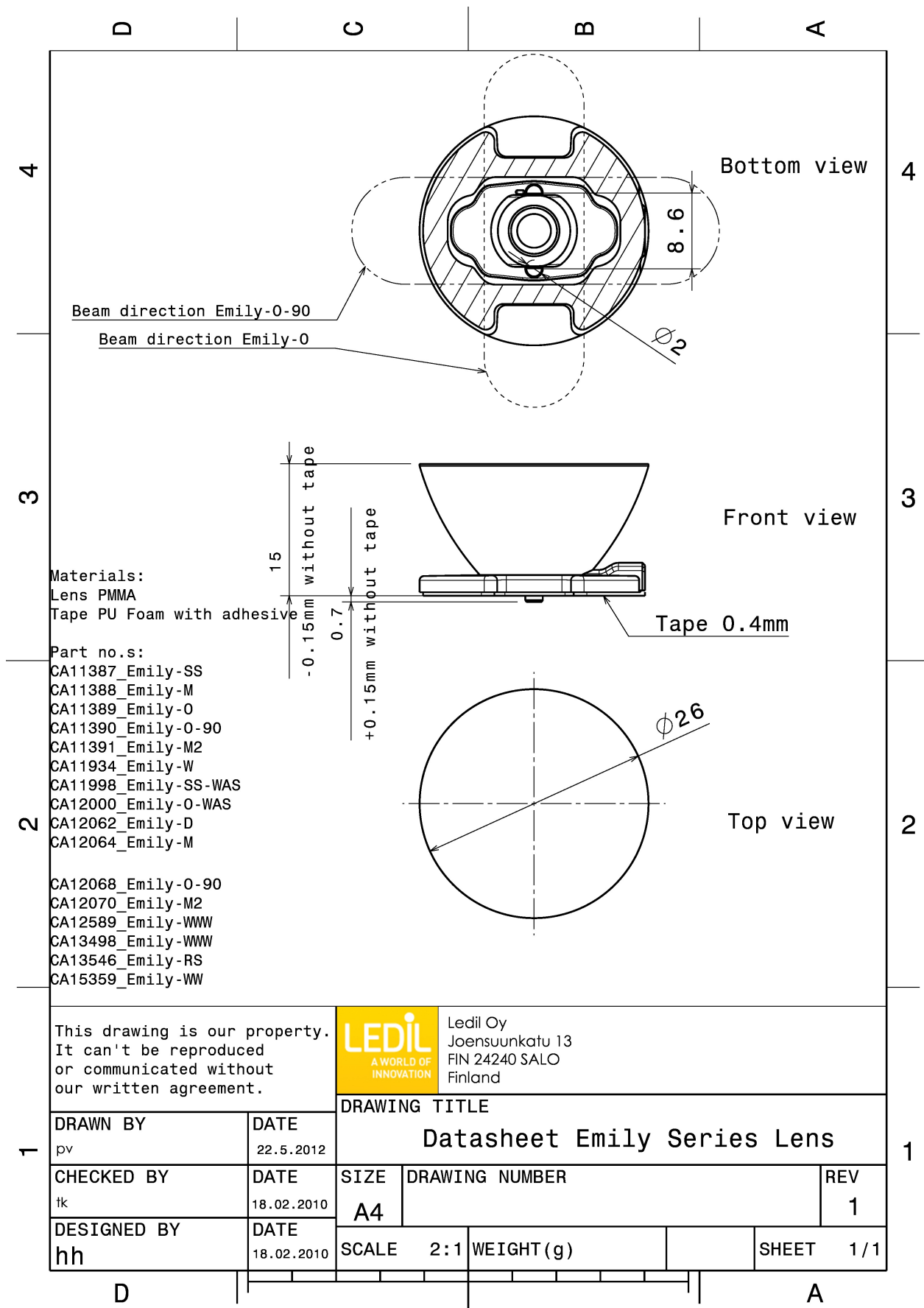

This drawing is our property. It can't be reproduced or communicated without our written agreement.

**LEDiL**  
A WORLD OF INNOVATION

Ledil Oy  
Joensuunkatu 13  
FIN 24240 SALO  
Finland

<b>DRAWN BY</b> pv		<b>DATE</b> 22.5.2012	<b>DRAWING TITLE</b> Datasheet Emily Series Lens		
<b>CHECKED BY</b> tk	<b>DATE</b> 18.02.2010	<b>SIZE</b> A4	<b>DRAWING NUMBER</b>		<b>REV</b> 1
<b>DESIGNED BY</b> hh	<b>DATE</b> 18.02.2010	<b>SCALE</b> 2:1	<b>WEIGHT (g)</b>	<b>SHEET</b> 1/1	

**PHOTOMETRIC DATA (MEASURED):**



LED XB-H  
FWHM 9.0°  
Efficiency 88 %  
Peak intensity 24.700 cd/Im  
Required components:

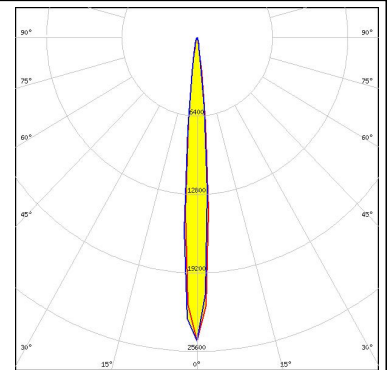
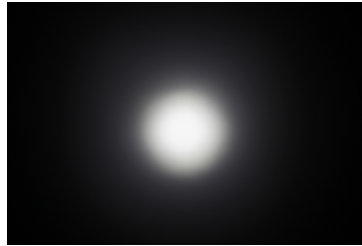

LED XP-G3  
FWHM 10.0°  
Efficiency 94 %  
Peak intensity 18.000 cd/Im  
Required components:

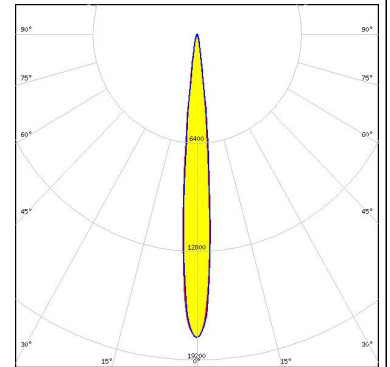

LED XP-L  
FWHM 13.0°  
Efficiency 89 %  
Peak intensity 13.100 cd/Im  
Required components:

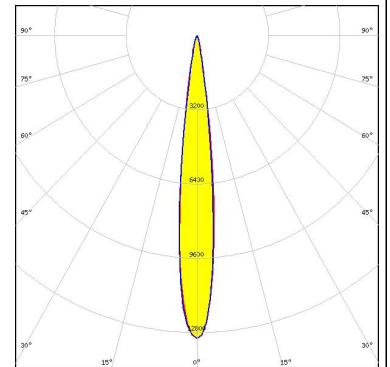

LED XP-L HI  
FWHM 8.0°  
Efficiency 88 %  
Peak intensity 28.000 cd/Im  
Required components:

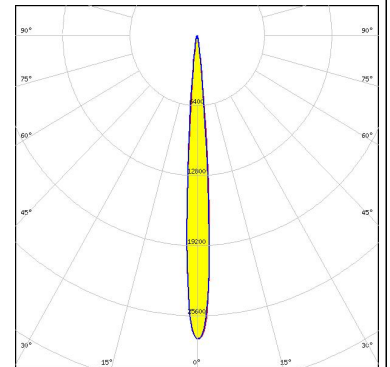

**PHOTOMETRIC DATA (MEASURED):**



LED LUXEON Z ES  
FWHM 5.0°  
Efficiency 91 %  
Peak intensity 52.000 cd/lm  
Required components:

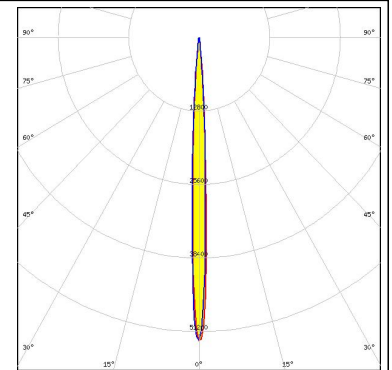

LED Oslon Square EC  
FWHM 8.0°  
Efficiency 90 %  
Peak intensity 29.100 cd/lm  
Required components:

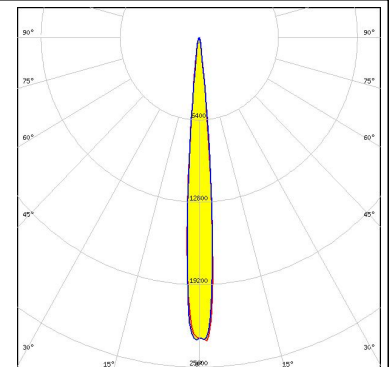
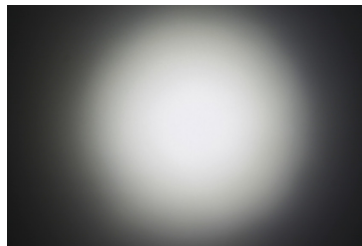

LED Z5M1/Z5M2  
FWHM 9.0°  
Efficiency 91 %  
Peak intensity 23.700 cd/lm  
Required components:

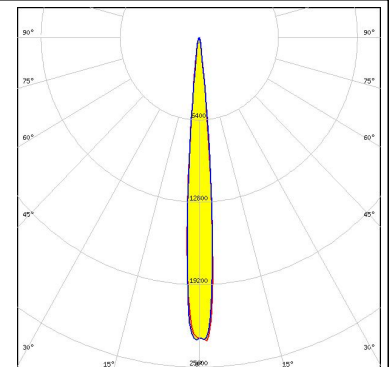
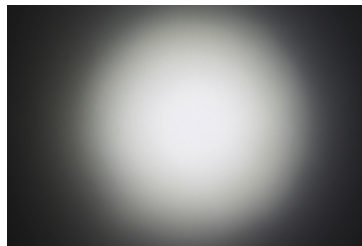

#### PHOTOMETRIC DATA (SIMULATED):

<p><b>LUMILEDS</b></p> <p>LED                    LUXEON Z</p> <p>FWHM                5.9°</p> <p>Efficiency           94 %</p> <p>Peak intensity      65.300 cd/lm</p> <p>Required components:</p>	
<p><b>OSRAM</b> Opto Semiconductors</p> <p>LED                    Oslon Black</p> <p>FWHM                11.0°</p> <p>Efficiency           94 %</p> <p>Peak intensity      19.700 cd/lm</p> <p>Required components:</p>	
<p><b>OSRAM</b> Opto Semiconductors</p> <p>LED                    Oslon Black Flat</p> <p>FWHM                6.3°</p> <p>Efficiency           94 %</p> <p>Peak intensity      50.400 cd/lm</p> <p>Required components:</p>	
<p><b>OSRAM</b> Opto Semiconductors</p> <p>LED                    Oslon Square Gen3</p> <p>FWHM                11.0°</p> <p>Efficiency           94 %</p> <p>Peak intensity      19.400 cd/lm</p> <p>Required components:</p>	

### GENERAL INFORMATION:

NOTE: The typical beam angle will be changed by different color, chip size and chip position tolerance. The typical total beam angle is the full angle measured where the luminous intensity is half of the peak value.

### MATERIALS:

As part of our continuous research and improvement processes, and to ensure the best possible quality and availability of our products, LEDiL reserves the right to change material grades without notice.

### PRODUCT DATA USER AGREEMENT AND DISCLAIMER:

The measured data in the provided downloadable LEDiL Product Datasheets and Mechanical 2D-Drawings is rounded and provided as reference for planning. LEDiL Oy's optical specifications have been verified by conducting performance testing of the products in accordance with the company's quality system. The reported data are averaged results of multiple measurements with typical variation. LEDiL Oy reserves the right to without prior notification make changes and improvements to its products.

LEDiL Oy assumes neither warranty, nor guarantee nor any other liability of any kind for the contents and correctness of the provided data. The provided data has been generated with highest diligence but the provided data may in reality not represent the complete possible variation range of all intrinsic parameters. Therefore, in certain cases a deviation from the provided data could occur.

LEDiL Oy reserves the right to undertake technical changes of its products without further notification which could lead to changes in the provided data. LEDiL Oy assumes no liability of any kind for the possible deviation from any provided data or any other damage resulting from the usage of the provided data.

The user agrees to this disclaimer and user agreement with the download or usage of the provided files.

#### LEDiL Oy

Joensuunkatu 13  
FI-24240 SALO  
Finland

#### LEDiL Inc.

228 West Page Street  
Suite D  
Sycamore IL 60178  
USA

#### Local sales and technical support

[www.ledil.com/  
where\\_to\\_buy](http://www.ledil.com/where_to_buy)

#### Shipping locations

Salo, Finland  
Hong Kong, China

#### Distribution Partners

[www.ledil.com/  
where\\_to\\_buy](http://www.ledil.com/where_to_buy)