

# APPROVAL SHEET

## 承認書

Customer 客戶名稱	
Part No. 產品型號	TVL-55781GD050J-LW-G-AAN
Product type 產品內容	5.0" TFT module: Transmissive Type, Positive mode, RGB vertical stripe
RoHS 綠色產品	<input type="checkbox"/> Non-compliance <input checked="" type="checkbox"/> Compliance
Remarks 備註欄	
<input checked="" type="checkbox"/> Preliminary Specification 暫行規格 <input type="checkbox"/> Final Specification 正式規格  Signature by Customer: 客戶確認簽章:	

Issued by QA	Checked by QA	Checked by PM	Approved By	
			QA	RD



KYOCERA Display Corporation

RoHS  
COMPLIANT

## Specification of LCD Module

Product No.: TVL-55781GD050J-LW-G-AAN

Issue date: 2013/02/21

KYOCERA DISPLAY CORPORATION

5-7-18, Higashinippori Arakawa-ku ,

Tokyo 116-0014, Japan

TEL: +81-3-5811-8780

FAX: +81-3-5811-8782

## **TABLE OF CONTENTS**

<b>1. REVISION HISTORY</b> .....	<b>5</b>
<b>2. GENERAL DESCRIPTION</b> .....	<b>6</b>
<b>3. FEATURES</b> .....	<b>6</b>
<b>4. MECHANICAL SPECIFICATION</b> .....	<b>6</b>
<b>5. MECHANICAL DIMENSION</b> .....	<b>7</b>
<b>6. MAXIMUM RATINGS</b> .....	<b>8</b>
<b>7. ELECTRICAL CHARACTERISTICS</b> .....	<b>9</b>
7.1. TFT LCD Characteristic .....	9
7.2. Backlight Characteristic .....	9
<b>8. MODULE FUNCTION DESCRIPTION</b> .....	<b>10</b>
8.1. PIN Description .....	10
8.2. Timing characteristics .....	13
<b>9. ELECTRO-OPTICAL CHARACTERISTICS</b> .....	<b>15</b>
<b>10. RELIABILITY</b> .....	<b>17</b>
10.1. TESTS.....	17
<b>11. INSPECTION CRITERIA</b> .....	<b>18</b>
11.1. Acceptable quality level(MIL-STD-105E LEVELII ).....	18
11.2. Definition of inspection area.....	18
11.3. Basic conditions for inspection .....	19
11.4. Inspection Item and Criteria .....	19
<b>12. ILLUSTRATION OF LCD DATE CODE</b> .....	<b>23</b>
<b>13. PACKAGING</b> .....	<b>23</b>
13.1. Procedure.....	23
<b>14. ROHS COMPLIANT WARRANTY</b> .....	<b>23</b>
<b>15. PRECAUTIONS FOR USE</b> .....	<b>23</b>



KYOCERA Display Corporation

15.1.	Safety .....	23
15.2.	Storage Conditions.....	23
15.3.	Installing LCD Module .....	24
15.4.	Precautions For Operation .....	24
15.5.	Handling Precautions .....	24
15.6.	Warranty.....	25

KYD Confidentialia Document



KYOCERA Display Corporation

# 1. REVISION HISTORY

Version	Revise record	Date
A	New version	2012/6/11

KYD Confidentialia Document

## 2. GENERAL DESCRIPTION

TVL-55781GD050J-LW-G-AAN is a Transmissive type color active matrix liquid crystal display (LCD), which uses amorphous thin film transistor (TFT) as switching devices. This product is composed of a TFT LCD panel, driver ICs, FPC, and a backlight unit. The following table described the features of TVL-55781GD050J-LW-G-AAN.

## 3. FEATURES

Display Mode	Transmissive Type
	Amorphous TFT LCD
	Normally white
Display Format	RGB Stripe type
Color	262K Color
Interface	RGB data bus, 18 bit parallel data
Viewing Direction	6 O'clock
Backlight type / color	LED / White

## 4. MECHANICAL SPECIFICATION

Item	Specifications	Unit
Dimensional outline	120.7 (W) × 75.8 (H) × 3.15 (D)*	mm
Resolution	480×3(R,G,B)×272	dot
Active area	110.88 (W) × 62.832 (H)	mm
Dot pitch	0.231 (W) × 0.231 (H)	mm
Polarizer	Anti-Glare (Haze:40%)	

\* Exclude FPC

# 5. MECHANICAL DIMENSION

FOR REFERENCE ONLY

Customer's Approval

Customer	
Date	

**NOTE :**  
 ○ ION MEANING CPK DIM.  
 Silicone applied to cover trace , but NOT IC

**DETAIL "A"**  
 SCALE 2/1

**DETAIL "B"**  
 SCALE 40/1

**LEGEND:**

- Date Code Area
- Solder Area
- Mylar Tape
- Single Side Area

REVISION RECORD	SCALE	TOLERANCE	DATE	ORG	DATE	MARK
A		±0.2			05.30.12	
B						Mark
C						
D						
E						

**PROJECT NO.:**

**MODULE:**

**DWG NO.:** LCM125060-1A

**VERSION:** A

## 6. MAXIMUM RATINGS

ITEM	SYMBOL	MIN.	MAX.	UNIT
Digital supply voltage	AVDD	-0.5	+5.0	V
Power Supply for Pump		-0.3	+7.0	V
Logic supply voltage	DVDD	-0.5	+5.0	V
Operation Temperature	T <sub>A</sub>	-20	85	°C
Storage Temperature	T <sub>stg</sub>	-40	85	°C
Single LED forward current	I <sub>F</sub>	-	30	mA

Note:

0. All of voltage listed above are with respect to GND=VSS=0V.
  - b. Device is subject to be damaged permanently if stresses beyond those absolute maximum ratings listed above.
- C: T<sub>A</sub> ≤ 40°C Without dewing.



## 7. ELECTRICAL CHARACTERISTICS

### 7.1. TFT LCD Characteristic

Typical operating conditions

(GND=DGND=AGND=0V)

Item	Symbol	Min.	Typ.	Max.	Unit	Note
Digital power supply	AVDD	3.0	3.3	3.6	V	
Charge Pump Supply Voltage		3.0	3.3	3.6	V	CPSEL="L" (Default)
		2.6	2.7	3.0	V	CPSEL="H"
Digital interface supply Voltage	DVDD	1.8		AVDD		
Driver Input signal voltage	H	$V_{IH}$	$0.7 \cdot DVDD$	-	DVDD	V
	L	$V_{IL}$	GND	-	$0.3 \cdot DVDD$	V
Supply current	IDD	-		22.5	mA	

### 7.2. Backlight Characteristic

Item	Symbol	Values			Unit	Remark
		Min.	Typ.	Max.		
Power Consumption	$P_{LED}$	-	924	-	mW	
LED Current	$I_L$	-	40	-	mA	
LED Voltage	$V_L$	19.6	-	24.5	V	

**Note1: Kyocera Display suggests using constant current driving this backlight unit.**

**Note2: LED structure unit.**

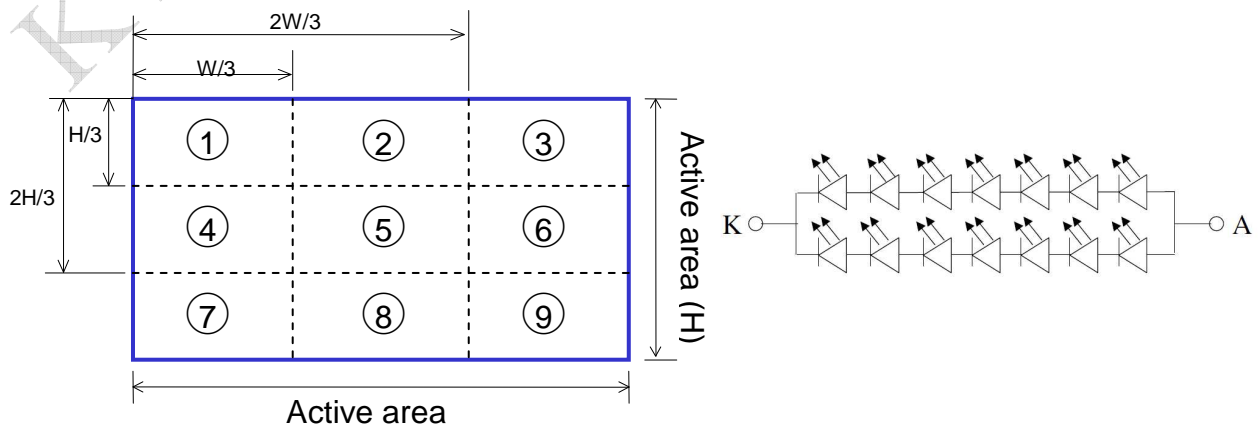

## 8. MODULE FUNCTION DESCRIPTION

### 8.1. PIN Description

Pin	Symbol	I/O	Function	Remark
1	VLED-	P	Power for LED backlight cathode	
2	VLED+	P	Power for LED backlight anode	
3	DGND	P	Ground for digital circuit	
4	NC	-	No connection	
5	NC	-	No connection	
6	NC	-	No connection	
7	NC	-	No connection	
8	AGND	P	Ground for analog circuit	
9	VGH	C	Stabilizing capacitor (2.2uF/25V)	25V爲耐壓值
10	C5M	C	Booster capacitor (2.2uF/6.3V)	
11	C5P	C	Booster capacitor (2.2uF/6.3V)	
12	C1AP	C	Booster capacitor (2.2uF/6.3V)	
13	C1AM	C	Booster capacitor (2.2uF/6.3V)	
14	VGL	C	Stabilizing capacitor (2.2uF/16V + Schottky diode ; Turn on voltage = 0.2V)	
15	C1BP	C	Booster capacitor (2.2uF/6.3V)	
16	C1BM	C	Booster capacitor (2.2uF/6.3V)	
17	AGND	P	Ground for analog circuit	
18	VCC25	C	Stabilizing capacitor (2.2uF/6.3V)	
19	C4P	C	Booster capacitor (1uF/16V)	
20	C4M	C	Booster capacitor (1uF/16V)	
21	AVDD	P	Digital and Charge pump supply voltage input pin for Booster circuit (3.3V) + (4.7uF/6.3V)	
22	ID2	I/O	High – high (Connect to AVDD on FPC)	
23	AGND	P	Ground for analog circuit	
24	VCC	C	Stabilizing capacitor (2.2uF/6.3V)	
25	C3P	C	Booster capacitor (1uF/16V)	
26	C3M	C	Booster capacitor (1uF/16V)	

27	ID1	I/O	Connect to AVDD on FPC	
28	GRB	I	System reset pin (active low)	
29	PGND	P	Ground for booster circuit	
30	DVDD	P	Digital interface supply voltage input (1.8V/3.3V) + (2.2uF/6.3V)	
31	CAVDD	C	Stabilizing capacitor (4.7uF/10V)	
32	PGND	P	Ground for booster circuit	
33	STB	I	Standby control signal	
34	CSB	I	Chip select pin for serial interface	
35	SDA	I	Data input pin in serial mode	
36	SCL	I	Clock input pin in serial mode	
37	VINT2	C	Stabilizing capacitor (2.2uF/16V)	
38	DEN	I	Display enable pin from controller	
39	B7	I	Blue data	
40	B6	I	Blue data	
41	B5	I	Blue data	
42	B4	I	Blue data	
43	B3	I	Blue data	
44	B2	I	Blue data	
45	G7	I	Green data	
46	G6	I	Green data	
47	G5	I	Green data	
48	G4	I	Green data	
49	G3	I	Green data	
50	G2	I	Green data	
51	R7	I	Red data	
52	R6	I	Red data	
53	R5	I	Red data	
54	R4	I	Red data	
55	R3	I	Red data	
56	R2	I	Red data	
57	NC	-	No connection	
58	NC	-	No connection	
59	CLK	I	Dot-clock and oscillator source	
60	VINT1	C	Stabilizing capacitor (4.7uF/10V)	

61	PGND	P	Ground for booster circuit	
62	VINT3	C	Stabilizing capacitor (4.7uF/10V)	
63	VCOMH	C	Stabilizing capacitor (4.7uF/6.3V)	
64	VCOML	C	Stabilizing capacitor (4.7uF/6.3V)	
65	DGND	P	Ground for digital circuit	
66	C2P	C	Booster capacitor (1uF/10V)	
67	C2M	C	Booster capacitor (1uF/10V)	

KYD Confidentialia Document

## 8.2. Timing characteristics

### 8.2.1. Timing Chart.

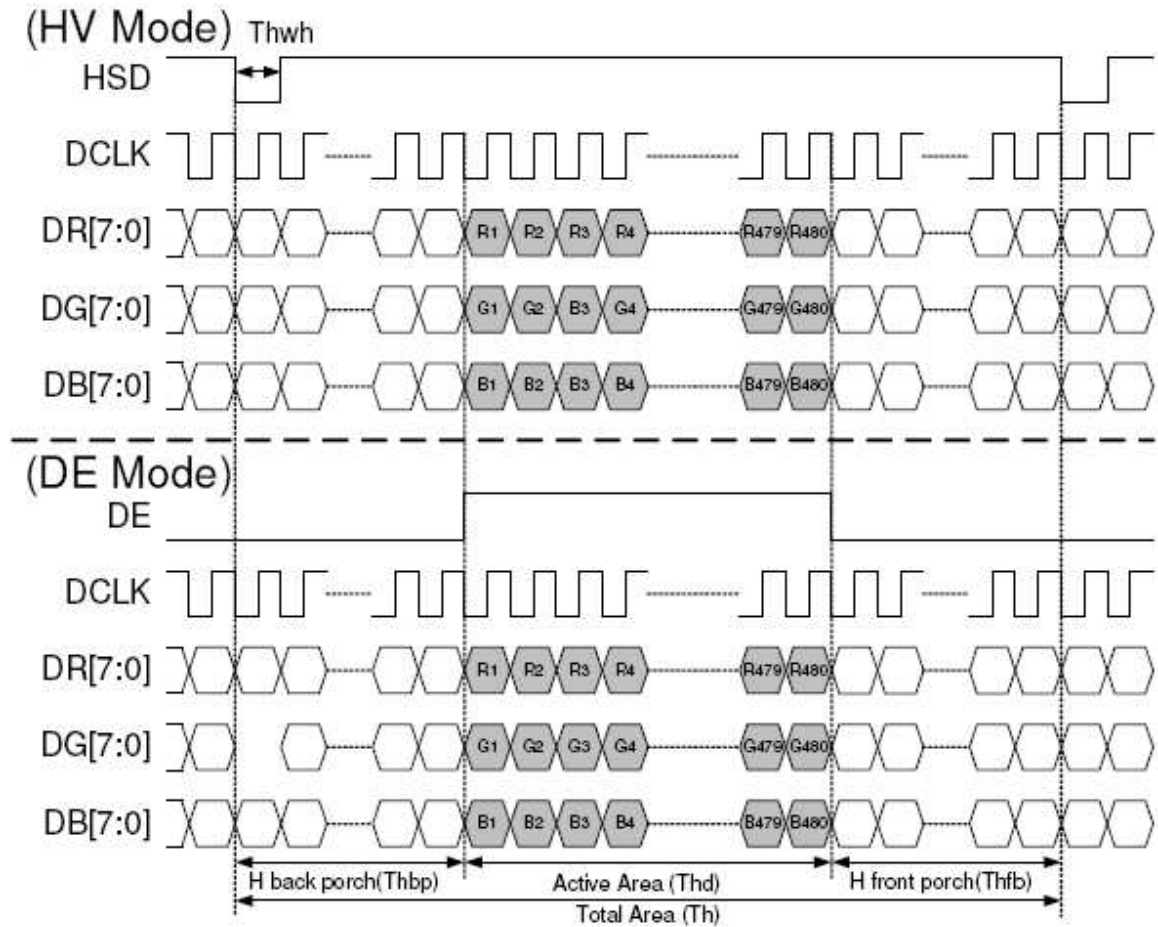

### 8.2.2. Timing Specification

Parameter	Symbol	Value			Unit
		Min.	Typ.	Max.	
DCLK frequency	fclk	5	9	12	MHz
VSD period time	$T_v$	277	288	400	H
VSD display area	$T_{vd}$	272			H
VSD back porch	$T_{vb}$	3	8	31	H
VSD front porch	$T_{vfp}$	2	8	93	H
HSD period time	$T_h$	520	525	800	DCLK
HSD display area	$T_{hd}$	480			DCLK
HSD back porch	$T_{hbp}$	36	40	255	DCLK
HSD front porch	$T_{hfp}$	4	5	65	DCLK

### 8.2.3.Color data Assignment

COLOR	INPUT DATA	R DATA								G DATA								B DATA							
		R7	R6	R5	R4	R3	R2	R1	R0	R7	R6	R5	R4	R3	R2	R1	R0	R7	R6	R5	R4	R3	R2	R1	R0
		MSB							LSB	MSB							LSB	MSB							LSB
BASIC COLOR	BLACK	0	0	0	0	0	0	0	0	0	0	0	0	0	0	0	0	0	0	0	0	0	0	0	0
	RED(255)	1	1	1	1	1	1	1	1	0	0	0	0	0	0	0	0	0	0	0	0	0	0	0	0
	GREEN(255)	0	0	0	0	0	0	0	0	1	1	1	1	1	1	1	1	0	0	0	0	0	0	0	0
	BLUE(255)	0	0	0	0	0	0	0	0	0	0	0	0	0	0	0	0	1	1	1	1	1	1	1	1
	CYAN	0	0	0	0	0	0	0	0	1	1	1	1	1	1	1	1	1	1	1	1	1	1	1	1
	MAGENTA	1	1	1	1	1	1	1	1	0	0	0	0	0	0	0	0	1	1	1	1	1	1	1	1
	YELLOW	1	1	1	1	1	1	1	1	1	1	1	1	1	1	1	1	0	0	0	0	0	0	0	0
	WHITE	1	1	1	1	1	1	1	1	1	1	1	1	1	1	1	1	1	1	1	1	1	1	1	1
RED	RED(0)	0	0	0	0	0	0	0	0	0	0	0	0	0	0	0	0	0	0	0	0	0	0	0	0
	RED(1)	0	0	0	0	0	0	0	1	0	0	0	0	0	0	0	0	0	0	0	0	0	0	0	0
	RED(2)	0	0	0	0	0	0	1	0	0	0	0	0	0	0	0	0	0	0	0	0	0	0	0	0
	RED(254)	1	1	1	1	1	1	1	0	0	0	0	0	0	0	0	0	0	0	0	0	0	0	0	0
	RED(255)	1	1	1	1	1	1	1	1	0	0	0	0	0	0	0	0	0	0	0	0	0	0	0	0
GREEN	GREEN(0)	0	0	0	0	0	0	0	0	0	0	0	0	0	0	0	0	0	0	0	0	0	0	0	0
	GREEN(1)	0	0	0	0	0	0	0	0	0	0	0	0	0	0	0	1	0	0	0	0	0	0	0	0
	GREEN(2)	0	0	0	0	0	0	0	0	0	0	0	0	0	0	1	0	0	0	0	0	0	0	0	0
	GREEN(254)	0	0	0	0	0	0	0	0	1	1	1	1	1	1	1	0	0	0	0	0	0	0	0	0
	GREEN(255)	0	0	0	0	0	0	0	0	1	1	1	1	1	1	1	1	0	0	0	0	0	0	0	0
BLUE	BLUE (0)	0	0	0	0	0	0	0	0	0	0	0	0	0	0	0	0	0	0	0	0	0	0	0	0
	BLUE (1)	0	0	0	0	0	0	0	0	0	0	0	0	0	0	0	0	0	0	0	0	0	0	0	1
	BLUE (2)	0	0	0	0	0	0	0	0	0	0	0	0	0	0	0	0	0	0	0	0	0	0	1	0
	BLUE (254)	0	0	0	0	0	0	0	0	0	0	0	0	0	0	0	0	1	1	1	1	1	1	1	0
	BLUE (255)	0	0	0	0	0	0	0	0	0	0	0	0	0	0	0	0	1	1	1	1	1	1	1	1

[NOTE] :

- 2) Definition of Gray level : Color(n) : n to show the Gray level , n is the more high and the light more bright.
- 3) Data:1-High, 0-Low.

## 9. ELECTRO-OPTICAL CHARACTERISTICS

The following items are measured under stable conditions. The optical characteristics should be measured in dark room or equivalent state with the methods shown in Note 1.

Item		Symbol	Condition	Min	Typ	Max	Unit	Remark
Brightness				400	-	-	cd/m <sup>2</sup>	Note 2
Uniformity				-	75	-	%	
Response time		T <sub>R</sub> +T <sub>F</sub>	Θ=0	-	25	-	ms	Note 3
Contrast ratio		CR	At the center point of A.A.	-	500	-		Note 4
Color Chromaticity	White	W <sub>x</sub>	Θ=0	0.27	0.31	0.35		Note 5
		W <sub>y</sub>		0.27	0.31	0.35		
NTSC					70		%	
Viewing Angle	12'	φ <sub>H</sub>	CR □ 10		50	-	Degree	Note 6
	3'	θ <sub>R</sub>			65	-		
	6'	φ <sub>L</sub>			60	-		
	9'	θ <sub>L</sub>			65	-		

T<sub>a</sub>=25±2□

### Note:

#### 1. Testing condition:

Stabilizing and leaving the panel only at room temperature for 30 minutes  
The measurement should be executed in a stable, windless, and dark room.

The Optical specifications are measured by Topcon BM-5A with a viewing angle of 2° at a distance of 50cm.

#### 2. Brightness= Nine-point average measurement.

Brightness Min.

Uniformity =  $\frac{\text{Brightness Min.}}{\text{Brightness Max.}}$  X 100%

Brightness Max.

#### 3. Definition of response time: T<sub>R</sub> and T<sub>F</sub>

The figure below is the output signal of the photo detector.

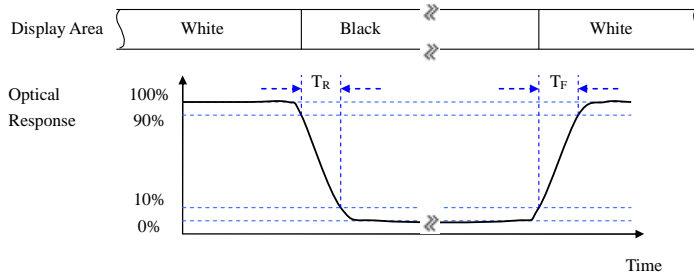

**4. Definition of contrast ratio:**

$$\text{Contrast ratio (CR)} = \frac{\text{Brightness measured when LCD is at "white state"}}{\text{Brightness measured when LCD is at "black state"}}$$

5. Measured at the center area of the panel when all the input terminals of LCD panel are electrically opened.

**Definition of viewing angle:**

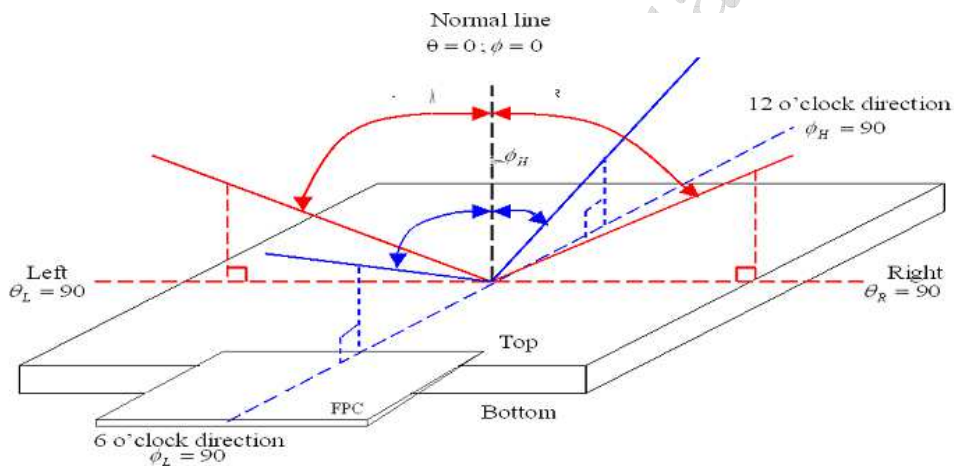



## 10.RELIABILITY

### 10.1.TESTS

NO.	ITEM	CONDITION	CRITERION
1	High Temperature Operating Life test	85°C 120 hrs	1. Function check should be executing immediately during operating test in the chamber
2	High Temperature Operating Life test	70°C 240 hrs	
3	Low Temperature Operating Life test	- 30°C 240 hrs	2. Function check should be executing immediately after the storage test.
4	High Temperature Storage test	85°C 240 hrs	
5	Low Temperature Storage test	-40°C 240hrs	
6	Humidity test	60°C *90%RH 240 hrs	
7	Thermal Shock	-30°C ←(5min)→ +80°C , (30min) (30min) 10 cycle	
8	Electrical Static Discharge	Contact: ±4KV, 150pF/330Ω	5 times to every corners of active area.
		Non-contact:±8KV,150pF/330Ω FPC pin: ±2KV, 150pF/330Ω	

Note 1: The sampling above is individual for each reliability test item.

Note 2: The color fading of polarizing filter should not care.

Note 3: All of the reliability testing chamber above, is using D.I. water.(Min value:1.0 MΩ -cm)

Note 4: In case of malfunction defect caused by ESD damage, if it would be recovered to normal state after resetting, it would be judged as a good part.

Note 5: In the case of cosmetic defect at 85°C/120 hrs test, as long as the module appears to be in the same aspect as before the test when recovering to 70°C, the module would be judged as normal.

## 11.INSPECTION CRITERIA

### 11.1.Acceptable quality level(MIL-STD-105E LEVELII )

The AQL define:

Inspection Item	Major defect	Minor defect
Cosmetic	1.0%	1.5%
Electrical test	0.4%	0.65%

### 11.2.Definition of inspection area

V.A: Viewing Area

A.A: Active Area

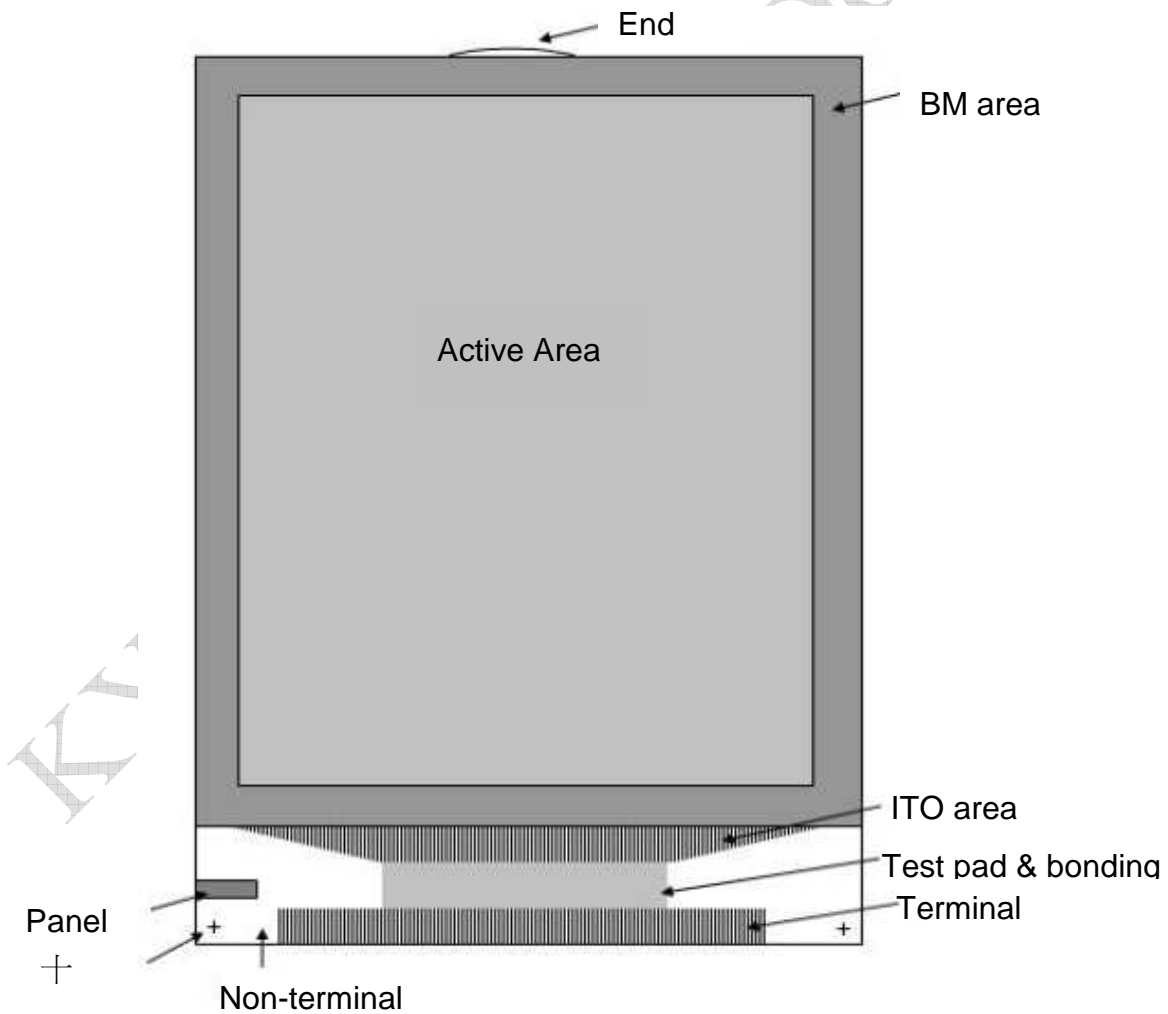

### 11.3. Basic conditions for inspection

11.3.1. Environment lamp under  $1000 \pm 200$  lux, Viewing direction for inspection over 30 cm.

11.3.2. The distance from eye to defect around 200mm, the distance from ND Filter to defect around 25~30mm. (Only MURA Defect)

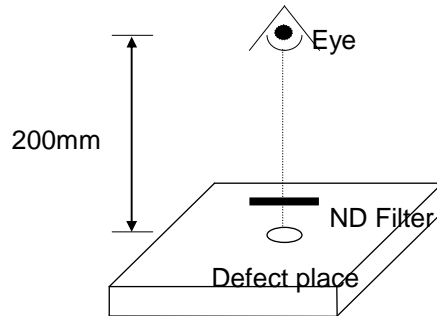

### 11.4. Inspection Item and Criteria

#### 11.4.1. Cosmetic criterion

##### (1) Glass defect

No	Defect	Criteria	Remark
1	Dimension (Minor)	By engineering diagram	
2	Cracks (Major)	Extensive crack <b>【Reject】</b>	

##### (2) LCM appearance defect within A.A (Without Touch Panel)

No	Defect	Criteria	Remark
1	Round type (Minor)	Spec.	Permissible Q'ty
		$\psi < 0.20\text{mm}$	Disregard
		$0.20\text{mm} \leq \psi \leq 0.6\text{mm}$	4
		$0.6\text{mm} < \psi$	0
2	Scratch (Minor)	Spec.	Permissible Q'ty
		$W \leq 0.02\text{mm}$ and $L \leq 15\text{mm}$	Disregard
		$0.02\text{mm} < W \leq 0.1\text{mm}$ and $L \leq 15\text{mm}$	5

1.  $\psi = (L+W)/2$ ,  
L: Length, W: Width  
2. Disregard if out of A.A.

		<u>W&gt;0.1mm or L&gt;15mm</u>	0	
3	Fiber  (Minor)	<u>Spec.</u>	Permissible Q'ty	1.L: Length, W: Width 2. Disregard if out of A.A. 
		<u>W ≤ 1.5mm and L ≤ 2.0mm</u>	<u>5</u>	
		<u>W &gt; 1.5mm or L &gt; 2.0mm</u>	0	
4	Polarizer Bubble / Dent  (Minor)	<u>Spec.</u>	Permissible Q'ty	1. $\psi = (L+W)/2$ , L: Length, W: Width 2. Disregard if out of A.A. 
		<u><math>\psi &lt; 0.30\text{mm}</math></u>	Disregard	
		<u><math>0.30\text{mm} \leq \psi \leq 0.6\text{mm}</math></u>	<u>4</u>	
		<u><math>0.6\text{mm} &lt; \psi</math></u>	0	

## (3) FPC

No	Defect	Criteria	Remark
1	Copper peeling (Minor)	Copper peeling <b>【Reject】</b>	

## (4) Black tape

No	Defect	Criteria	Remark
1	Shift (Minor)	IC exposed <b>【Reject】</b>	
2	No black tape (Minor)	No black tape <b>【Reject】</b>	

## (5) Silicon

No	Defect	Criteria	Remark
1	Amount of silicon (Minor)	ITO exposed <b>【Reject】</b>	

## (6) Bezel

No	Defect	Criteria	Remark
1	Oxidized spot (Minor)	Oxidized spot, rust <b>【Reject】</b>	

2	Outline deformation (Minor)	By engineering diagram	
3	Greasiness (Minor)	Greasiness <b>【Reject】</b>	
4	Spots, round Type (Minor)	$H \leq$ By engineering diagram <b>【Disregard】</b>	H=Total height (thickness)
5	Plating (Minor)	Bubble, peeling <b>【Reject】</b>	



## (7) Power cord

No	Defect	Criteria	Remark
1	Power cord (Minor)	Power core loose	

## 11.4.2.LCM electrical criterion

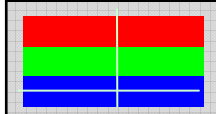
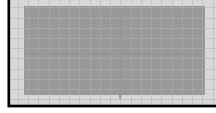
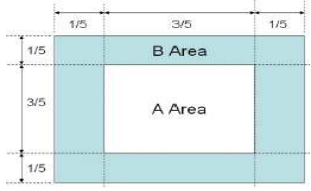
## (1).LCM electrical criterion (Without Touch Panel)

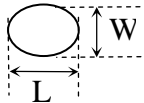
No	Defect	Criteria			Remark	
1	No display (Major)	Not allowed				
2	Missing line (Major)	Not allowed				
3	Darker or lighter line (Major)	Not allowed				
4	Bright / Dark point (Minor)		A Area	B Area	1.1sub-pixel: 1R or 1G or 1B 2.Point defect area $\geq$ 1/2 sub pixel. 	
		Bright point	<u>1</u>	<u>2</u>		<u>3</u>
		Dark dot point	<u>2</u>	<u>3</u>		<u>4</u>
		Bright +Dark point	<u>3</u>	<u>4</u>		<u>5</u>
5	Round type (Minor)	Spec.		Permissible Q'ty	1. $\psi = (L+W)/2$ , L: Length, W: Width 2. Disregard if out of A.A.	
		$\psi < 0.20\text{mm}$		Disregard		
		$0.20\text{mm} \leq \psi \leq 0.6\text{mm}$		<u>4</u>		

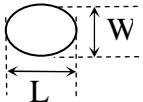
		$0.6\text{mm} < \psi$	0	
6	Scratch  (Minor)	<u>Spec.</u>	Permissible Q'ty	1.L: Length, W: Width 2. Disregard if out of A.A. 
		$W \leq 0.02\text{mm}$ and $L \leq 15\text{mm}$	Disregard	
		$0.02\text{mm} < W \leq 0.1\text{mm}$ and $L \leq 15\text{mm}$	<u>5</u>	
		$W > 0.1\text{mm}$ or $L > 15\text{mm}$	0	
7	Fiber  (Minor)	<u>Spec.</u>	Permissible Q'ty	1.L: Length, W: Width 2. Disregard if out of A.A. 
		$W \leq 1.5\text{mm}$ and $L \leq 2.0\text{mm}$	<u>5</u>	
		$W > 1.5\text{mm}$ or $L > 2.0\text{mm}$	0	
8	Polarizer Bubble / Dent  (Minor)	<u>Spec.</u>	Permissible Q'ty	1. $\psi = (L+W)/2$ , L: Length, W: Width 2. Disregard if out of A.A. 
		$\psi < 0.30\text{mm}$	Disregard	
		$0.30\text{mm} \leq \psi \leq 0.6\text{mm}$	<u>4</u>	
		$0.6\text{mm} < \psi$	0	
9	Mura  (Minor)	By 2% ND filter invisible		

1. Issues that are not defined in this document shall be discussed and agreed with both parties. (Customer and supplier)
2. Unless otherwise agreed upon in writing, the criteria shall be applied to both parties. (Customer and supplier)
3. Polarizer, more than 0.5mm in size reduction rejected

## 12. ILLUSTRATION OF LCD DATE CODE (TBD)

## 13. PACKAGING (TBD)

### 13.1. Procedure

## 14. RoHS COMPLIANT WARRANTY

RoHS Hazardous substances including:

- Cd < 100 ppm
- Pb < 1000 ppm
- Hg < 1000 ppm
- Cr +6 < 1000 ppm
- PBDE < 1000 ppm
- PBB < 1000 ppm

## 15. PRECAUTIONS FOR USE

### 15.1. Safety

- (1) Do not swallow any liquid crystal, even if there is no proof that liquid crystal is poisonous.
- (2) If the LCD panel breaks, be careful not to get liquid crystal to touch your skin.
- (3) If skin is exposed to liquid crystal, wash the area thoroughly with alcohol or soap.

### 15.2. Storage Conditions

- (1) Store the panel or module in a dark place where the temperature is  $23\pm 5^{\circ}\text{C}$  and the humidity is below  $50\pm 20\% \text{RH}$ .
- (2) Store in anti-static electricity container.
- (3) Store in clean environment, free from dust, active gas, and solvent.

- (4) Do not place the module near organics solvents or corrosive gases.
- (5) Do not crush, shake, or jolt the module.
- (6) Do not exposed to direct sun light of fluorescent lamps.

### 15.3.Installing LCD Module

Attend to the following items when installing the LCM.

- (1) Cover the surface with a transparent protective plate to protect the polarizer and LC cell.
- (2) When assembling the LCM into other equipment, the spacer to the bit between the LCM and the fitting plate should have enough height to avoid causing stress to the module surface, refer to the individual specifications for measurements. The measurement tolerance should be  $\pm 0.1$ mm.

### 15.4.Precautions For Operation

- (1) Viewing angle varies with the change of liquid crystal driving voltage ( $V_0$ ). Adjust  $V_0$  to show the best contrast.
- (2) Driving the LCD in the voltage above the limit will shorten its lifetime.
- (3) Response time is greatly delayed at temperature below the operating temperature range. However, this does not mean the LCD will be out of the order. It will recover when it returns to the specified temperature range.
- (4) When turning the power on, input each signal after the positive/negative voltage becomes stable.
- (5) Do not apply water or any liquid on product which composed of T/P.

### 15.5.Handling Precautions

- (1) Avoid static electricity which can damage the CMOS LSI; please wear the wrist strap when handling.
- (2) The polarizing plate of the display is very fragile. so, please handle it very carefully.
- (3) Do not give external shock.
- (4) Do not apply excessive force on the surface; it may cause display abnormal .
- (5) Do not wipe the polarizing plate with a dry cloth, as it may easily scratch the surface of plate.
- (6) Do not use ketonics solvent & Aromatic solvent, use with a soft cloth soaked with a cleaning naphtha solvent.
- (7) Do not operate it above the absolute maximum rating.
- (8) Do not remove the panel or frame from the module.
- (9) Do not apply water or any liquid on product, which composed of T/P.



## 15.6.Warranty

- (1) The period is within 12 months since the date of shipping out under normal using and storage conditions.
- (2) The warranty will be avoided in case of defect induced by customer.

KYD Confidentialia Document