

N 50 Ω

Attenuator
Plug / Jack 10 Watt

53AS110-K30N3

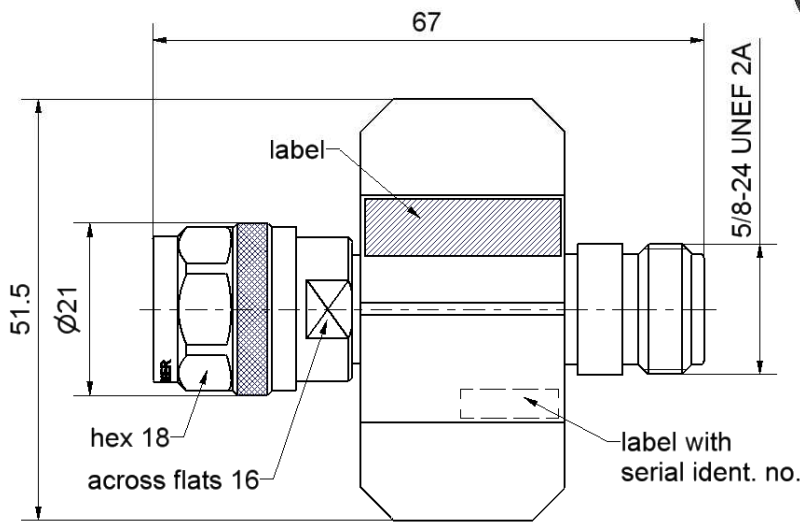
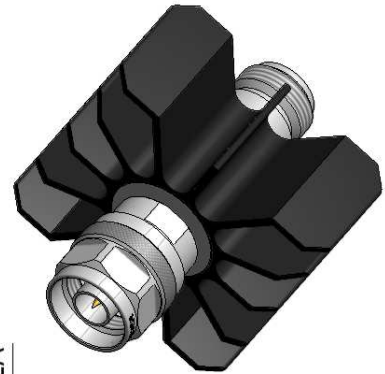

All dimensions are in mm; tolerances according to ISO 2768 m-H

Interface

According to IEC 61169-16

Documents

N/A

Material and plating

Connector parts

- Center conductor - plug
- Center conductor - jack
- Outer conductor
- Coupling nut
- Heatsink
- Dielectric
- Substrate

Material

- Brass
- Beryllium copper
- Brass
- Brass
- Aluminum
- PTFE
- AIN

Plating

- Gold, min. 1.27 μm , over nickel
- Gold, min. 1.27 μm , over nickel
- Flash white bronze over silver(e.g. Optargen®)
- White bronze(e.g. Optalloy®)
- Black anodized

N 50 Ω

Attenuator
Plug / Jack 10 Watt

53AS110-K30N3

Electrical data

Impedance 50 Ω
 Frequency DC to 10 GHz
 Return loss ≥ 26.4 dB, DC to 2 GHz
 ≥ 21.2 dB, 2 GHz to 5 GHz
 ≥ 14.0 dB, 5 GHz to 10 GHz
 Attenuation 30 dB ± 0.4 dB, DC to 2 GHz
 30 dB ± 0.5 dB, 2 GHz to 4 GHz
 30 dB ± 1.75 dB, 4 GHz to 10 GHz
 Power handling (at 25 °C, sea level) ≤ 10 W, derated linearity by 0.1 W/K

Mechanical data

Mating cycles ≥ 500
 Coupling nut retention ≥ 450 N
 Center contact captivation ≥ 28 N
 Coupling test torque ≤ 1.7 Nm
 Recommended torque 0.7 Nm to 1.1 Nm

Environmental data

Temperature range -65 °C to +125 °C
 RoHS compliant

Tooling

N/A

Suitable cables

N/A

Packing

Standard 1 pce in air cushion bag
 Weight 155 g/pce

While the information has been carefully compiled to the best of our knowledge, nothing is intended as representation or warranty on our part and no statement herein shall be construed as recommendation to infringe existing patents. In the effort to improve our products, we reserve the right to make changes judged to be necessary.

Draft	Date	Approved	Date	Rev.	Engineering change number	Name	Date
Kerstin Herzog	05.08.05	Markus Müller	20.07.18	c00	18-1027	Marion Striegler	20.07.18
Rosenberger Hochfrequenztechnik GmbH & Co. KG P.O.Box 1260 D-84526 Tittmoning Germany www.rosenberger.de						Tel. : +49 8684 18-0 Email : info@rosenberger.de	
							Page 2 / 2