

Evaluation Hardware/Software User Manual for RGB Sensor

Introduction

The RGB Evaluation Kit is designed to evaluate the performance of the RGB sensor. The kit is accompanied by a Graphical User Interface (GUI) that contains the CIE 1931 Chromaticity diagram with Planckian locus in an x, y- coordinate system, with cross marks to point out where the RGB sensor position is on the graph. The GUI facilitates evaluation of parameters such as raw data of Red, Green and Blue as well as X, Y and Z corrected lux measurements and also performs interrupt functions. Data can be viewed on the GUI and/or saved to a text file for future analysis. The GUI software is compatible with Windows XP®, Windows Vista®, Windows® 7 and Windows® 8. This provides a simple user interface for exercising the device features.

The system (MCU, DUT) is powered directly from the universal serial bus (USB) or from a single-supply voltage of 2.25V to 3.6V. The evaluation board must be connected to a computer through the mini USB port for the system to function. The system uses a USB MCU to communicate to the DUT via I²C/SMBus interface.

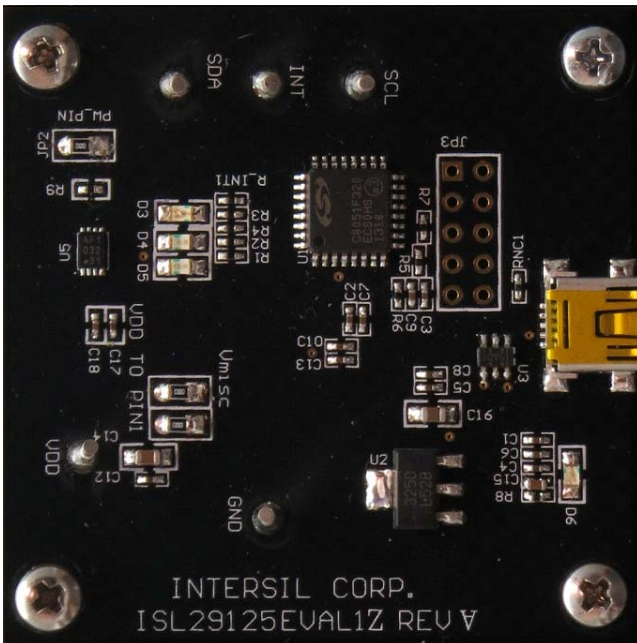

FIGURE 1. EVALUATION BOARD

Ordering Information

PART NUMBER	DESCRIPTION
ISL29125EVAL1Z	Evaluation Board

Reference Documents

- [RGB Chroma Meter Setup](#)
- [Standard Illuminants](#)
- [Chromaticity](#)
- [Color temperature](#)
- [Planckian locus](#)
- [Colour & Vision Research Laboratory](#)
- [Mired](#)
- [CIELUV](#)
- [Least Squares](#)
- [Linear Regression](#)
- [CIE 1960 Color Space \(MacAdam - uv\)](#)
- [Wratten Number](#)

Evaluation Package (Online Order)

The package consists of the hardware, software and documentation listed in the following:

- User Guide (Online)
- [ISL29125 Datasheet](#) (Online)
- Presentation (Installer File)
- uv-xy table (Installer File)
- CCM Calibration Worksheet (Installer File)
- User Guide (Installer File)

Hardware Requirements

- Mini USB cable
- Evaluation board

Installation of the Graphical User Interface (GUI) Software and USB Driver

Download the software from the [RGB Chroma Meter Setup](#).

Once the application is downloaded from the website, double-click the file to start installing the GUI. The user will be greeted by the screen shown in [Figure 2](#). Continue through the installer and read the instructions. [Figures 2](#) through [6](#) on [page 2](#) show the complete installation process.

The USB evaluation board should always be connected via the USB until the installation has been satisfactorily completed.

Application Note 1914

The installation program places the user interface software in the directory indicated in [Figure 5](#).

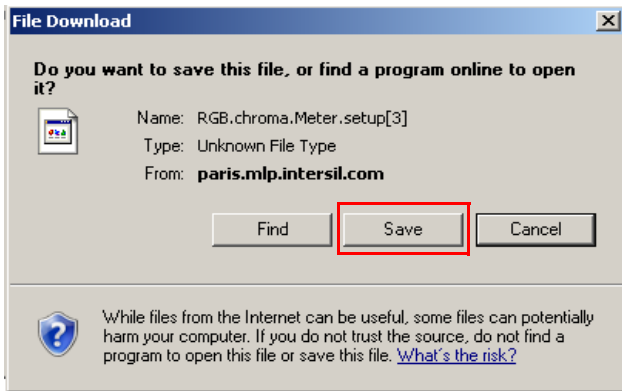

FIGURE 2. INSTALLATION WELCOME SCREEN

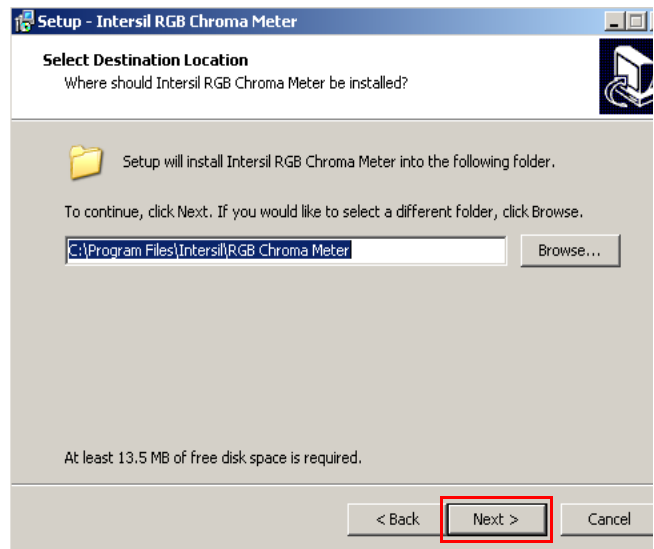

FIGURE 5. INSTALLATION DESTINATION LOCATION SCREEN

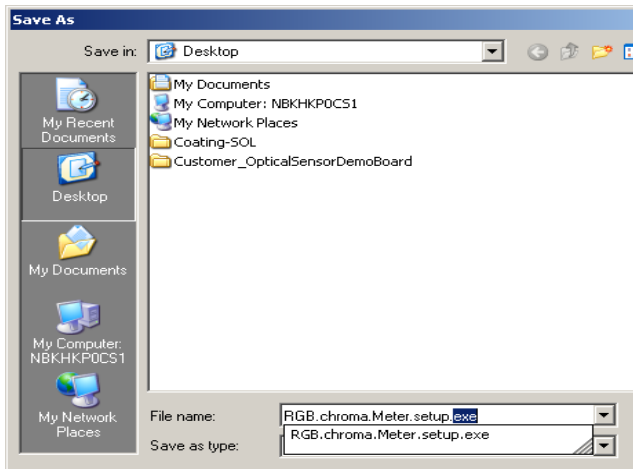

FIGURE 3. INSTALLATION FOLDER LOCATION SCREEN

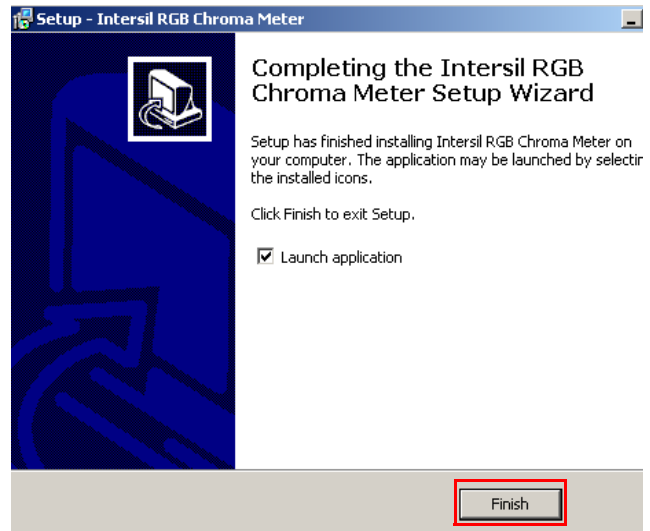

FIGURE 6. INSTALLATION COMPLETE SCREEN

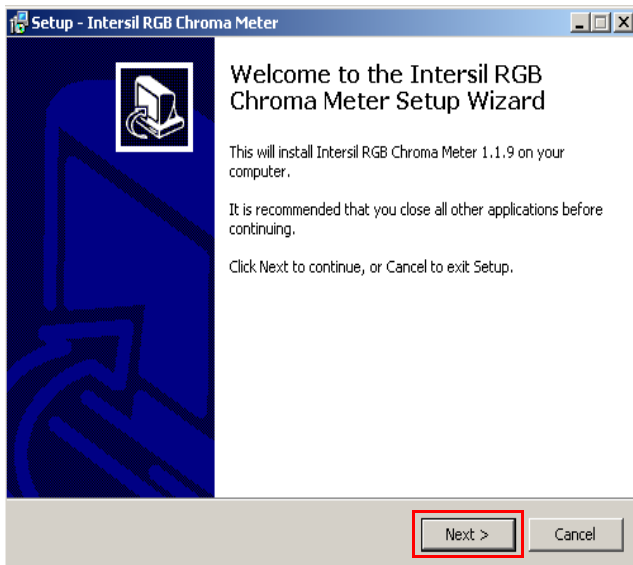

FIGURE 4. INSTALLATION LICENSE AGREEMENT SCREEN

Application Note 1914

Running Program for the RGB GUI

- A) **USB Communication (Hardware)** - Gather the required materials and connect the PC to the ISL29125 by mini USB cable as shown in [Figure 7](#).



FIGURE 7. ISL29125 EVALUATION BOARD CONNECTED TO PC BY MINI USB

Once the evaluation board is connected to the PC, D6, which is next to mini USB socket at the bottom of evaluation board, should light up. If the LED is not ON, please check your connection.

- B) **Launching the RGB GUI** - Once the installation is complete, click "Finish" to launch the RGB GUI. If you wish to launch from your PC desktop, use the path shown in [Figure 8](#). (Start → Program → Intersil → RGB Chroma Meter → Chroma Meter.

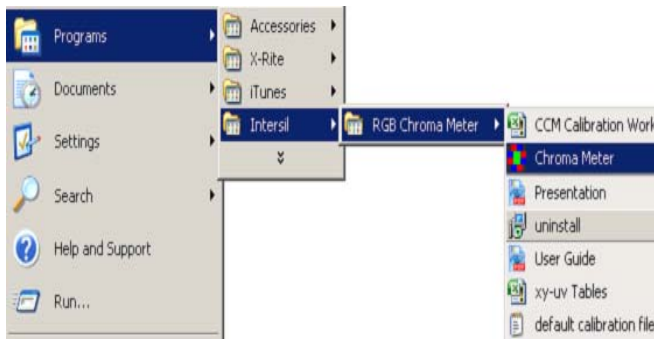

FIGURE 8. INSTALLATION READY TO INSTALL SCREEN

- C) Once "ChromaMeter" is clicked, the window displayed in [Figure 9](#) should open. If it does not display cross-points in the Chromaticity diagram on the right and numbers on the left panel of GUI, then check your connections. If the problem still persists, then you may want to restart the software. [Figure 12](#) shows the error message that displays if the evaluation board is improperly attached.

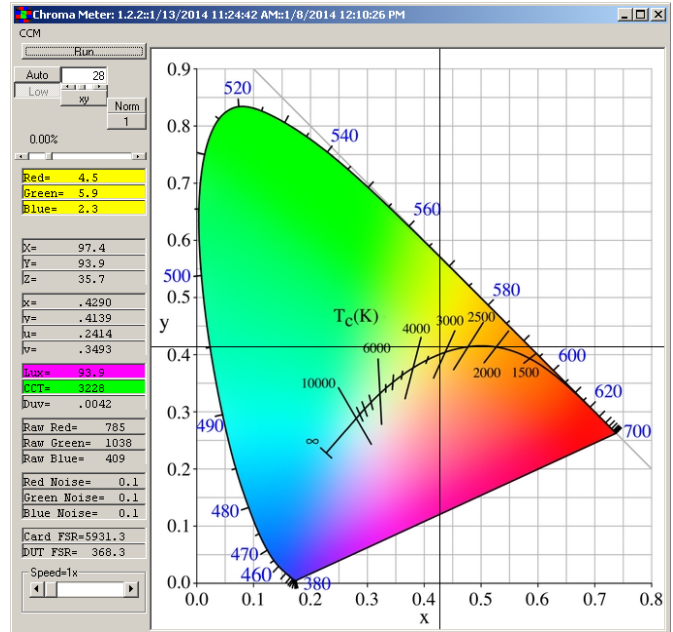

FIGURE 9. CHROMA TEST GUI

- D) [Figure 9](#) shows an example using the ISL29125. Please note that all demonstrations within this document use the ISL29125.

A detailed explanation of the operating modes can be found in the datasheet of the individual devices and [Figure 10](#) details the GUI display.

Application Note 1914

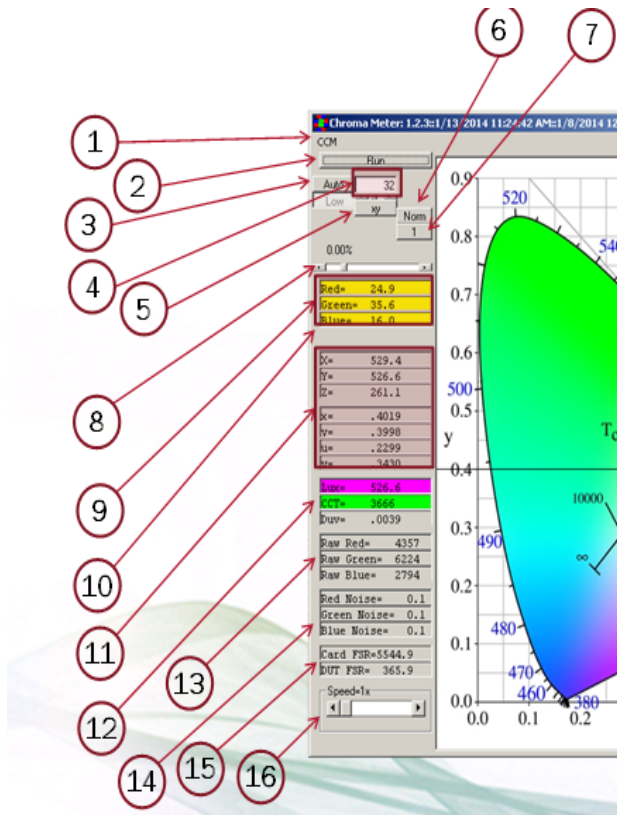

FIGURE 10. GUI DISPLAY DETAILS

1. CCM: Allows user load new coefficients if they have a custom system setup.
2. Run button: By default sensor will run continuously. When pressed, data will be held at the last value.
3. Auto button: Auto ranges from range0 to range1 or once it is toggled to "Fixed" Then sensor can do single range depending on user selection.
4. Compensation: Scroll-bar allows user to set compensation value for sensor under different light sources. Display window shows compensation value. Range is between 0 through 127.
5. xy button: Shows Planckian locus graph in xy coordinate system on the right hand side (colored graph) or, once it is toggled, then uv-coordinates will be displayed (colored graph).
6. Selects between normal and maximum high sensitivity on the low range only.
7. Enables 32 sample averaging.
8. Allows user to change absolute gain of corrected lux value to match the Lux Meter (CL-200 or T-10). The absolute gain can be changed to $\pm 50\%$.
9. Raw data of Red, Green and Blue read from ISL29125 in percentage of full scale per range.
10. dIR: percentage IR value changes relative to full scale from compensation = 0. The higher IR value in the display window means sensor is under stronger IR-content lamp.
11. XYZ displays show corrected value Lux value, which transfers from raw RGB to XYZ. xy/uv displays show corrected xy/uv coordinate system of sensor to Planckian locus.

12. Lux display shows corrected lux which has been transformed to equal Y. CCT displays shows color temperature of light source.
13. Raw ADC output code.
14. RMS noise of raw RGB values in %/value.
15. Card/DUT FSR: Full scale (in Lux) of the evaluation card and the sensor (internal to the card).
16. Speed: Allows the user to select the number of ADC bits and the speed of the conversion. Details shown in Figure 9.

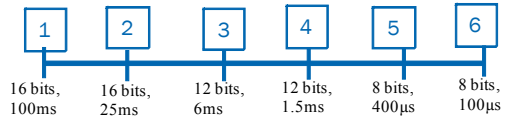

FIGURE 11. OPTICAL SENSOR SPEED MODE SELECTION

- E) The values displayed on the main panel include:
 - Calibrated Lux and CCT measurements
 - X, Y, Z values
 - xy coordinates
 - uv coordinates
 - RGB ADC output codes and noise levels
- F) Once the evaluation board and GUI are operating, the cross-points will start moving along the blackbody curve. By changing the color temperature of the light-bulbs, the cross-points will move along with that temperature. For example, if the user uses CL-200 (color lux meter) to measure color temperature and certain lux level of an illuminant (3200K) then takes the CL-200 out and replaces with the evaluation board, the cross-points and lux value on the GUI will be around 3200K of the black body curve and lux value will be matched with the lux that is read at CL-200. The user can continue testing the board by changing the color temperature bulb (2800K to 6500K).
- G) Exit the GUI by clicking the "X" button on the top right corner of the GUI.

Troubleshoot

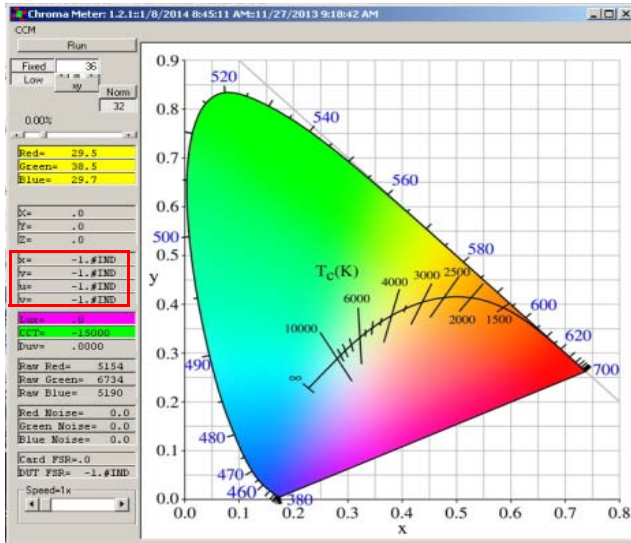

FIGURE 12. USB CONNECTED ERROR OR EEPROM FILE DOES NOT LOAD

1. If installer does not complete, check the USB to make sure the evaluation board is connected to the PC.
2. If the cross-point does not display to match with the color temperature light bulb, the user needs to check x, y and z values at left GUI panel. If x, y and z are all -1, Color Correction Matrix (CCM) did not load properly. The user should click on the "CCM" button at top left corner in the GUI Panel. Another pop-up window will display as shown in [Figure 13](#).
3. To open the CCM Worksheet, go to the "Start" menu, (Start → Intersil → RGB Chroma Meter → Chroma Meter → CCM Worksheet). The CCM Worksheet contains the coefficient for the specific evaluation board ([Figure 8](#), but choose CCM Worksheet Excel).
4. Once the CCM Excel Worksheet is opened, the user should look for the worksheet number which is matched with his/her evaluation board number.
5. User should copy the CCM, which is highlighted in Green color "EEPromVersion3" then paste into item 14 shown in [Figure 13](#).
6. Click "Write" at item 3 then "Read" at Item 2 to configure the EEPROM on the evaluation board.
7. Click "Write" at item 7 then "Read" at item 6 to save CCM into file.

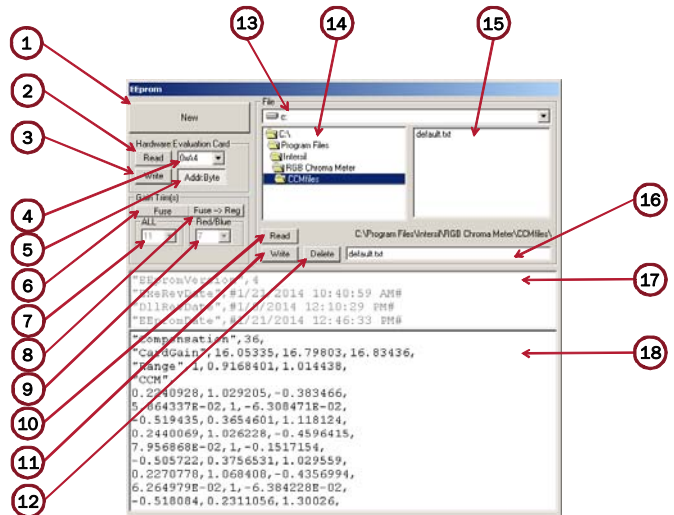

FIGURE 13. EEPROM LOAD CCM (CORRECTION COLOR MATRIX) FILE

Detailed explanation of the CCM PANEL can be found in the following:

1. New
2. Hardware Read
3. Hardware Write
4. Address Select
5. Byte/Word Address mode
6. Fuse/Reg Select
7. Fuse Trim: MSB Nibble (ALL - Coarse) $\pm 22\%$ (3% resolution)
8. Copy Fuse set to Reg
9. Fuse Trim: LSB Nibble (R&B Only - Fine) $\pm 6\%$ (0.8% resolution)
10. File Read
11. File Write
12. File Delete
13. Drive select
14. Directory select
15. File Select
16. File display/edit
17. Header contents (read only)
18. Calibration values

For other questions, comments, and feedback, contact the local [Intersil FAE/Sales team](#).

Application Note 1914

ISL29125EVAL1Z Bill of Materials

QTY	UNITS	REFERENCE DESIGNATOR	DESCRIPTION	MANUFACTURER	MANUFACTURER PART
8	ea	C1, C2, C3, C4, C5, C12, C13, C17	CAP, SMD, 0402, 0.1µF, 50V, 10%, X7R, ROHS	TDK	C1005X7R1H104K
6	ea	C6, C7, C8, C9, C10, C18	CAP, SMD, 0402, 1.0µF, 25V, 10%, X5R, ROHS	TDK	CGB2A1X5R1E105K033BC
1	ea	C15	CAP, SMD, 0402, 0.47µF, 25V, 10%, X5R, ROHS	TDK	C1005X5R1E474K050BB
2	ea	C14, C16	CAP, SMD, 0805, 10µF, 10V, 10%, X5R, ROHS	MUR	GRM21BR61A106KE19L
6	ea	GND, INT, REXT, SCL, SDA, VDD	CONN-TURRET, TH, SWAGE MNT, 0.230LENGTH, ROHS	MILL-MAX	2110-2-00-80-00-00-07-0
3	ea	JP1, P2, VDD to 3.3V	CONN-HEADER, 1X2, RETENTIVE, 2.54mm, 0.230 X 0.120, ROHS	BERG/FCI	69190-202HLF
2	ea	J1	CONN-USB RECEPTACLE, SMD, 5P, MINI B, R/A, ROHS	JAE ELECTRONICS	DX2R005HN2E700
3	ea	JP1, P2, VDD to 3.3V	CONN-JUMPER, SHORTING, 2PIN, BLACK, GOLD, ROHS	SULLINS	SPC02SYAN
1	ea	D5	LED, SMD, 0805, RED/CLEAR, 2V, 20mA, 631nm, 54mcd, ROHS	LITEON/VISHAY	LTST-C170KRKT
1	ea	D4	LED, SMD, 0805, BLUE/CLEAR, 3.4V, 20mA, 468nm, 30mcd, ROHS	LITEON/VISHAY	LTST-C171TBKT
2	ea	D3, D6	LED, SMD, 0805, GREEN, 2.1V, 20mA, 567nm, 6.4mcd, ROHS	STANLEY ELECTRIC	PG1112H-TR
1	ea	U5	IC-1.7V SERIAL EEPROM, 2k-BIT I2C, 8P, TDFN, ROHS	MICROCHIP TECHNOLOGY	24AA024HT-I/MNY
1	ea	U1	IC-USB µCONTROLLER, 32P, LQFP, HID-REV1 PROGRAM, ROHS	SILICON LABORATORIES	C8051F320-GQ
1	ea	U4	IC-DIGITAL LIGHT SENSOR, 6P, ODFN, 1.5x1.6, ROHS	INTERSIL	ISL29125IROZ
1	ea	U2	IC-1A LDO REGULATOR, SMD, SOT-223, 3.3V, ROHS, Pb-free	NATIONAL SEMICONDUCTOR	LM3940IMP-3.3/NOPB
1	ea	U3	IC-SINGLE USB PORT TVS, SMD, 6P, SOT-23-6, ROHS	TEXAS INSTRUMENTS	SN65220DBVR
2	ea	R3, R4	RES, SMD, 0402, 0Ω, 1/16W, 5%, TF, ROHS	VENKEL	CR0402-16W-00T
2	ea	R5, R6	RES, SMD, 0402, 1k, 1/16W, 1%, TF, ROHS	VENKEL	CR0402-16W-102JT
1	ea	R9	RES, SMD, 0402, 10k, 1/16W, 1%, TF, ROHS	PANASONIC	ERJ-2RKF1002X
1	ea	RNC1	RES, SMD, 0402, 100k, 1/16W, 1%, TF, ROHS	PANASONIC	ERJ2RKF1003
1	ea	R_INT1	RES, SMD, 0402, 300Ω, 1/16W, 1%, TF, ROHS	VISHAY/DALE	CRCW0402300RFKED
2	ea	R1, R2	RES, SMD, 0402, 4.7k, 1/16W, 1%, TF, ROHS	VENKEL	CR0402-16W-4701FT
1	ea	R8	RES, SMD, 0402, 499Ω, 1/10W, 1%, TF, ROHS	PANASONIC	ERJ-2RKF4990X

Intersil Corporation reserves the right to make changes in circuit design, software and/or specifications at any time without notice. Accordingly, the reader is cautioned to verify that the document is current before proceeding.

For information regarding Intersil Corporation and its products, see www.intersil.com

Sensor Carrier Board Silkscreen and Schematic

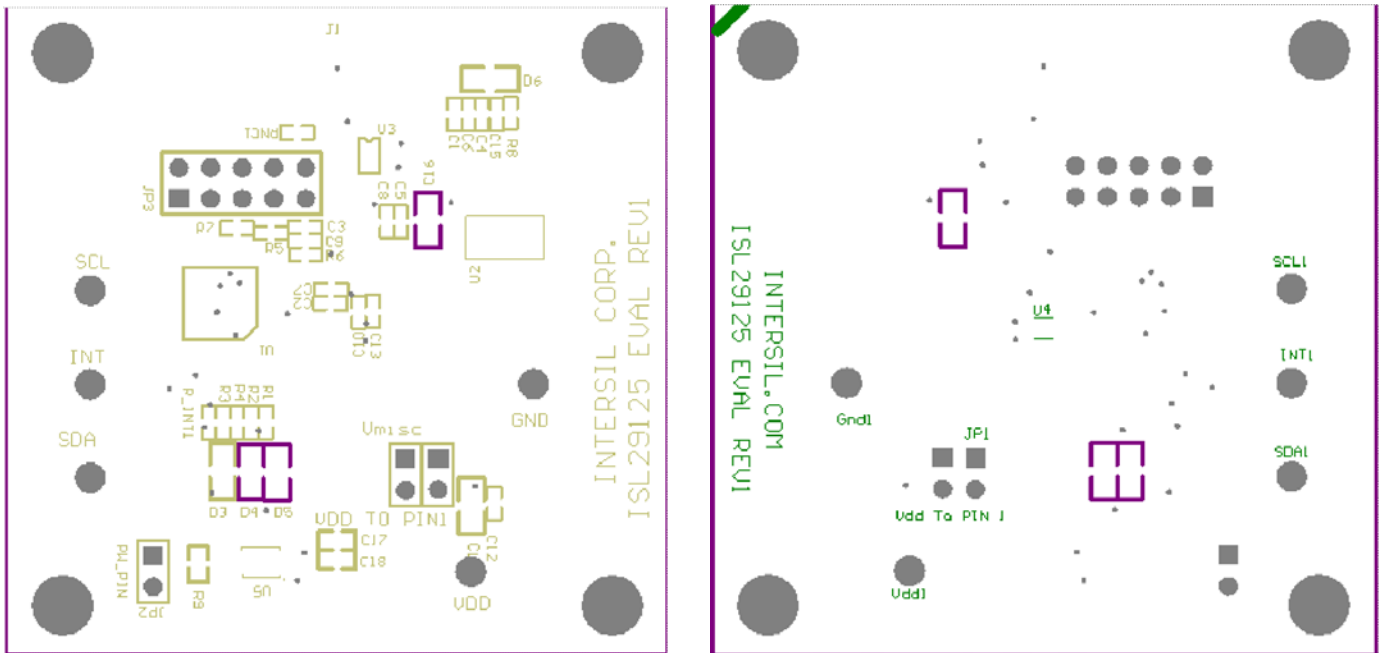

FIGURE 14. TOP AND BOTTOM SILKSCREEN

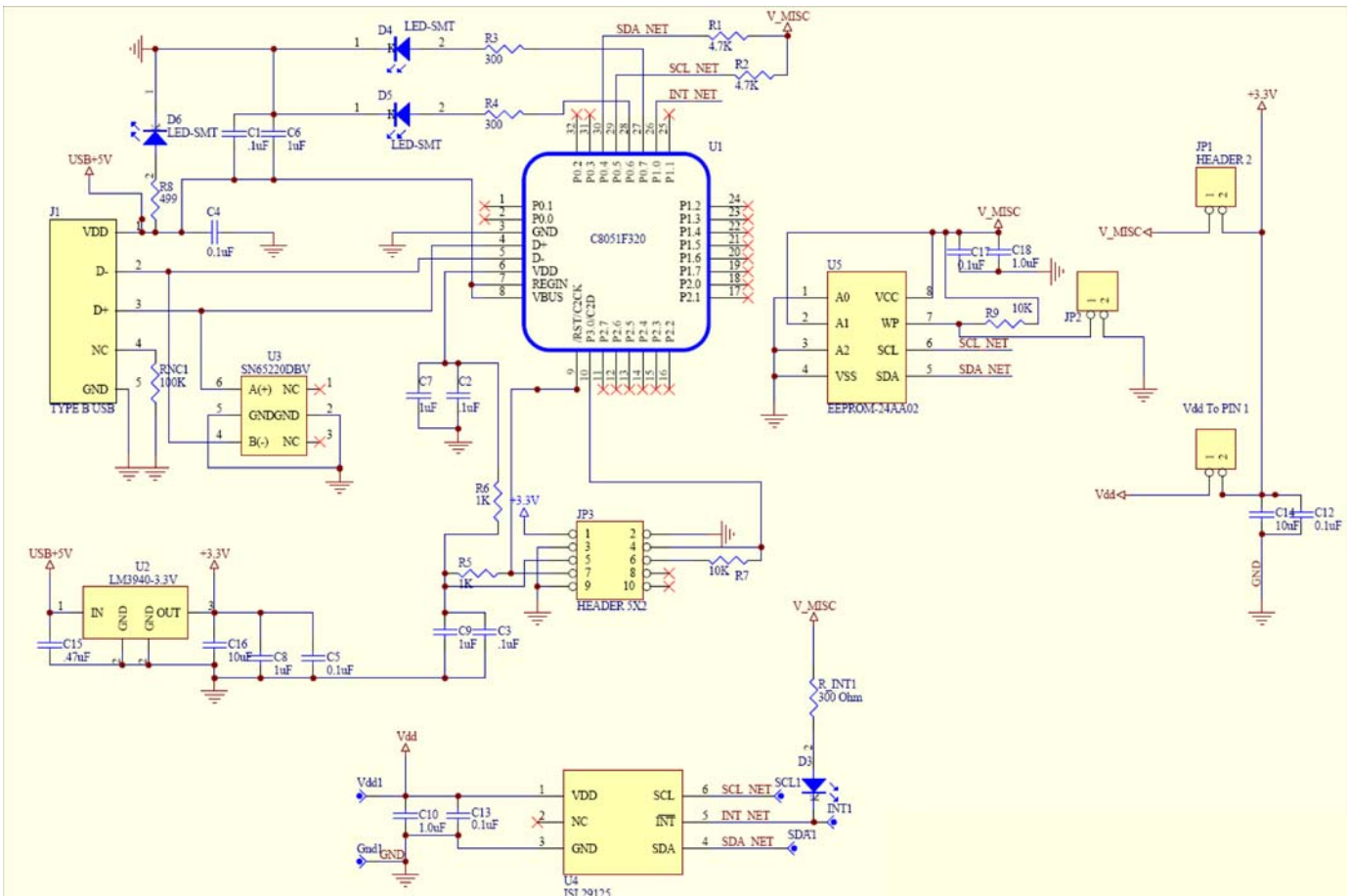

FIGURE 15. OPTICAL SENSOR CARRIER EVALUATION BOARD SCHEMATIC