

### 10KV Digital High Voltage Insulation Tester

### Model MG500

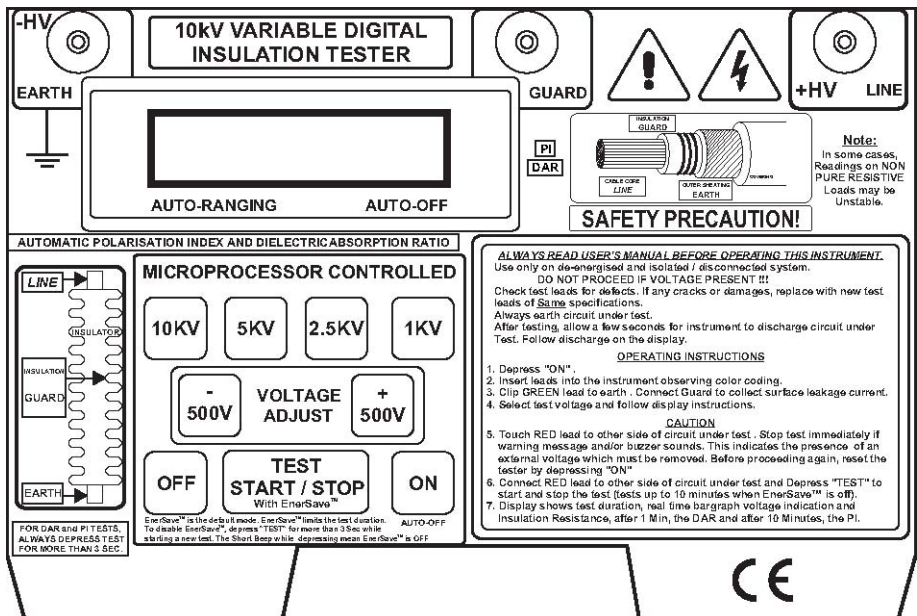

# Introduction

---

Thank you for selecting the Extech Instruments Model MG500. This device is shipped fully tested and calibrated and, with proper use, will provide years of reliable service. Please visit our website ([www.extech.com](http://www.extech.com)) to check for the latest version of this User Guide, Product Updates, and Customer Support.

## Safety

---

### International Safety Symbols



This symbol, adjacent to another symbol or terminal, indicates the user must refer to the manual for further information.



This symbol, adjacent to a terminal, indicates that, under normal use, hazardous voltages may be present



Double insulation



**CAUTION RISK OF ELECTRIC SHOCK**

This tester has been designed with safety in mind. However, no design can completely protect against incorrect use. Electrical circuits can be dangerous and lethal when a lack of caution and poor safety practices are used.

Do not take field measurements on either power system grounding during periods of lightning activity, or any non-insulated system or non-insulated circuit. In the event that lightning occurs, stop all testing and isolate and remove any temporarily installed test spikes or test leads.

Preparations for testing power system grounding (or close to it) can leave personnel vulnerable to exposure caused by faults at, or fed from, the system under test, transferred potentials from remote test grounds, and inadvertent line energizing. **Always insulate the device under test.**

While the probability of such occurrences is low, personnel safety will, nevertheless, be enhanced by the following:

When working near high tension systems rubber gloves and shoes should be worn. Work on clean, dry crushed rock or an insulating blanket. Avoid bare hand-to-hand contact between the tester and extended test leads.

When using the tester with test leads, ensure that they are safe and properly authorized. Disconnect the tester from any external circuit when checking or changing the fuse and/or batteries.



## CAUTION! READ THE MANUAL

Follow the instructions in the Manual for every measurement type. Read and understand the general instructions before attempting to use this instrument.

### SAFETY CHECK

Before using the tester check the condition of the test leads.

The test leads must be free of cracks or any damages and must be insulated.

Always disconnect the test leads when changing the batteries

Always double check the lead connections before making any measurements. For increased safety, use fused test leads (optional).

Do not touch exposed wiring, connections or other "live" parts of an electrical circuit. If in doubt, check the circuit first for voltage before touching it.



**THIS INSTRUMENT SHOULD ONLY BE USED BY COMPETENT, SUITABLY TRAINED PERSONNEL.**



**CAUTION! RISK OF ELECTRIC SHOCK**

**CAUTION! READ THE MANUAL**

Electricity can cause severe injuries even with low voltage or current. It is extremely important that the following information be read before using this High Voltage Digital Insulation Meter.

This instrument must only be used and operated by competent trained personnel and in strict accordance with the instructions and safety practices. Liability is not accepted for any damage or injury caused by misuse or non-compliance with instructions and safety procedures.

**This instrument must not be used on live circuits.** Ensure all circuits are de-energized before testing.

Never open this High Voltage Digital Insulation Meter except for battery replacement (See Battery Replacement section).

Always inspect this High Voltage Digital Insulation Meter and test leads before using for any sign of abnormality or damage. If any abnormal conditions exist (broken test leads, cracked case, display faulty etc...) do not attempt to take any measurement or use the tester. Return the Meter for service.

This Variable High Voltage Digital Insulation Meter has a live circuit warning beeper. If it is connected to a live circuit, a rapid pulsating tone will sound and a warning message will be displayed. In this case, stop testing and immediately disconnect the instrument from the circuit under test.

# Features

---

- **Insulation Resistance Testing**

This digital insulation resistance tester will measure insulation resistance from 800k ohms to 500G ohms using Dynamic Auto-ranging technology. Test voltages range from 500V to 10kV in 500 Volt steps. This instrument also employs an Auto-Discharge utility.

- **DAR: Dielectric Absorption Ratio Testing**

The Dielectric Absorption is the ratio of the Insulation Resistance, measured at 60 seconds, divided by the Insulation Resistance measured at 30 seconds).

DAR = Resistance measured at 1 minute / Resistance measured at 30 seconds

- **PI: Polarization Index Testing**

The Polarization Index is the ratio of the Insulation Resistance measured at 10 minutes divided by the Insulation Resistance measured at 1 minute.

PI = Resistance measured at 10 minutes / Resistance measured at 1 minute

- **Automatic Discharge of Capacitive and Inductive Circuits**

This instrument will automatically discharge all circuits, charged by the tester, upon completion of a test. The discharge can be observed on the instrument's bargraph display.

- **Automatic Battery Test**

When the instrument is first powered ON, a test circuit applies a heavy current draw on the batteries for a few seconds and measures the voltage in order to determine the capacity of the batteries. The result is shown on the display.

- **Normal Operation Mode Considerations**

This instrument uses Dynamic Current Auto-ranging technology. The bar graph will display the voltage that is stressing the insulation during the first 30 seconds of a test and during the discharge of the circuits at the end of the test. The display will also show the elapsed time from the start of the test and the total time, even after the testing has stopped.

- **Supplemental Features**

- Insulation Resistance auto-ranging on all Voltage ranges
- Automatic DAR calculation
- Automatic PI calculation
- Ener-Save™ Mode conserves battery energy during Insulation Resistance testing
- Overload protection
- Low battery indicator
- Auto Off feature
- Warning of external voltage presence (>500VAC or VDC)

# Description

1. Negative High Voltage (HV) Terminal (Earth Ground)
2. Dot Matrix Display window
3. GUARD connection Terminal
4. Positive High Voltage Line Terminal
5. 10KV test voltage preset button
6. Power OFF button
7. Voltage adjustment button (-)
8. 5KV test voltage preset button
9. TEST START/STOP button
10. 2.5KV test voltage preset button
11. 500V test voltage adjust button (+)
12. Power ON button
13. 1KV test voltage preset button

Note: Battery compartment located on bottom of instrument and test lead compartment located behind the upper faceplate.

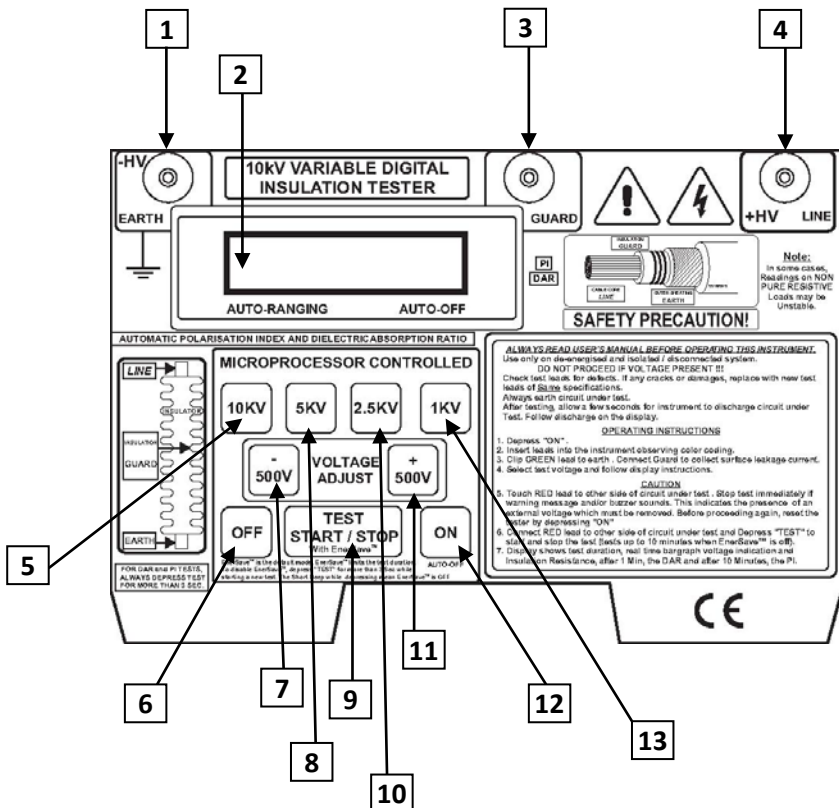

## Meter Preparation

---

**Warning:** Ensure that the circuit under test does not include devices or components that can be damaged by 10KVDC; such devices include power factor correction capacitors, low voltage mineral insulated cables, electronic light dimmers, ballasts and starters for fluorescent lamps.

### Connecting the Test Leads to the meter

- Connect the **Red (Line)** test lead to the Red test jack on the meter.
- Connect the **blue** lead (attached to the Red test lead) to the Blue test jack on the meter.
- Connect the **Green (Earth)** test lead to the Green test jack on the meter.

#### Optional Leakage guard

Connect the optional **Blue (Leakage guard)**, test lead to the Blue test jack.

NOTE: The **Blue (Leakage guard)** lead is attached directly to the top of the Blue guard lead of the Red test lead.

### Connecting the Test Leads to the device under test

**Warning:** make sure that the circuit under test is de-energized.

- Connect the **Green (Earth)** lead to the Earth or ground side of the insulator under Test.
- Connect the **Red (Line)** test lead to the other side of the Insulator under test.
- **Optional Leakage guard:** Connect the **Blue (Guard)** lead to the insulator sheathing and covering material as shown on the diagram. Use a copper wire wrapped around the insulator at about its center.

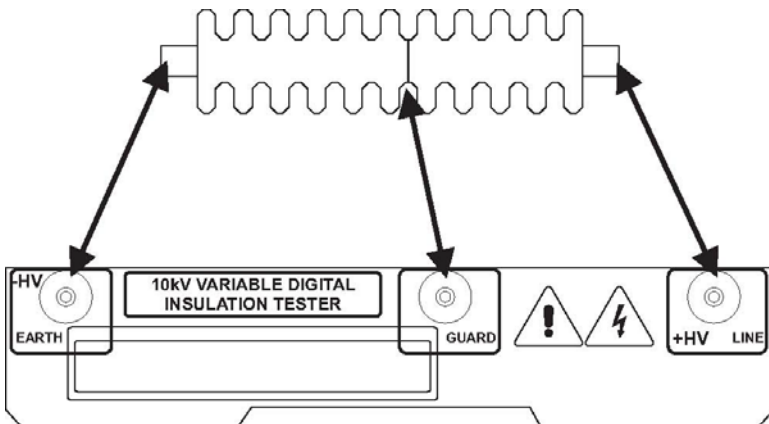

# Operation

---

## Powering the meter

Press the **ON** button to turn the unit on. Press the **OFF** button to turn the unit off. If the meter does not switch ON please check that fresh 'C' 1.5V alkaline batteries are installed in the battery compartment located at the bottom of the instrument.

## Insulation Resistance Testing Procedure

**Warning:** The circuit under test must be completely **de-energized** and isolated before making test connections.

1. After turning the unit on, make sure that the **Replace Battery** message is not displayed. If the **Replace Battery** message is displayed replace the batteries before proceeding.
2. The test voltage defaults to 2500V on power up. Select the desired test voltage using the Voltage Adjust buttons ( $\pm 500V$ ) that step through the available test voltages in 500V increments or by pressing one of the preset test voltage buttons (10kV, 5kV, 2.5kV, 1kV).
3. The display shows the **Connect Leads** prompt along with the selected test voltage value.

Connect the Green test lead to the Green test socket on the meter and then to the Ground side of the insulator under test.

Connect the Red lead to the Red test socket on the meter and the Blue guard cable to the blue socket on the meter. Connect the service end of the Red cable to other side of the insulator under test.

If a Leakage Guard lead is required to collect surface leakage, connect the separate Blue test lead into the Blue guard lead from the Red test lead which is plugged into the Blue test socket on the meter and then clip the service end of the cable to the surface of the insulator under test.

4. Momentarily Press the **TEST START/STOP** button (1.5s ~ 3 seconds) to start testing.  
For DAR or PI testing – refer to the separate test procedure below.
5. The Insulation resistance test will complete in 5 seconds. The test voltage percentage steadily counts down to zero during the test as can be seen on the display. The resistance test result value will appear on the display when the test has completed.
6. The HOLD icon will appear in place of the bargraph when the test is complete and after the voltage has been discharged.

**WARNING:** DO NOT REMOVE THE TEST LEADS BEFORE THE **HOLD** DISPLAY APPEARS.

7. The meter automatically discharges the system at the end of the test.
8. To take another test, press the **TEST START/STOP** button, the **Connect Leads** prompt should appear on the display; the instrument is now ready to run a new test.
9. The instrument automatically powers down after 5 minutes of inactivity.

## The Enersave™ Mode

Enersave™ mode conserves battery life by performing a relatively short test. The Enersave™ mode is the default test mode. To bypass this mode and run a longer test (10 minutes) press and hold the TEST button for more than 3 seconds when starting a test.

### DAR and PI Tests (DAR: Dielectric Absorption Ratio) and (PI: Polarization Index)

**Warning:** The circuit under test must be completely **de-energized** and isolated before making test connections.

1. After turning the unit on, make sure that the **Replace Battery** message is not displayed. If the **Replace Battery** message is displayed replace the batteries before proceeding.
2. The test voltage defaults to 2500V on power up. Select the desired test voltage using the Voltage Adjust buttons ( $\pm 500V$ ) that step through the available test voltages in 500V increments or by pressing one of the preset test voltage buttons (10kV, 5kV, 2.5kV, 1kV).
3. The display shows the **Connect Leads** prompt along with the selected test voltage value.

Connect the Green test lead to the Green test socket on the meter and then to the Ground side of the insulator under test.

Connect the Red lead to the Red test socket on the meter and the Blue guard cable to the blue socket on the meter. Connect the service end of the Red cable to other side of the insulator under test.

If a Leakage Guard lead is required to collect surface leakage, connect the separate Blue test lead into the Blue guard lead from the Red test lead which is plugged into the Blue test socket on the meter and then clip the service end of the cable to the surface of the insulator under test.

4. Press and hold the **Test Start/Stop** button for more than 3 seconds to initiate DAR/PI testing mode.
5. After 1 minute, the elapsed test timer appears on the upper line (right hand side) of the display. The resistance reading is shown on the upper left hand side of the display. The lower line shows the test voltage and the DAR value.
6. After 10 minutes, the test completes. The display will show the results:

**R** = (resistance or OVER R for over range)

**T** = Hold, T = 10:00, V = (test voltage)

**PI** = (PI value)

**DAR** = (DAR value)

7. To take another test, press the **TEST START/STOP** button, the **Connect Leads** prompt should appear on the display; the instrument is now ready to run a new test.



## **Bargraph Voltage Display**

The bargraph represents the voltage present on the test leads as it rises, soaks, and decays. The bargraph appears on the lower left of the display window during a test.

## **Automatic Under/Over Range Resistance Detect**

If the display shows the message “LOW M-ohms”, the test should be interrupted immediately by pressing the **TEST** button. This message indicates that the insulation under test has broken down and the meter is trying to inject a high potential onto a short circuit. If ‘HIGH’ appears, it is likely that the test configuration is open. Check the test set-up and then test again.

## **Elapsed Timer**

The test duration is indicated on the display. This is particularly useful in determining whether an insulating material under test will break down in a given amount of time.

## **Manual Test STOP**

To stop a test in progress, press the **TEST** button. The test will immediately end and the system will automatically discharge.

## **Automatic Test STOP**

When in the default Enersave™ mode, the test automatically stops in 5 seconds. When not in the Enersave™ mode the test automatically stops after approx. 10 minutes.

## **Live Circuit Warning**

If the test leads are connected to a live circuit (approx. 500V), a warning beeper will sound and the meter will display “Live Warning...Circuit Live...” In this case, correct the problem and retest.

## **Automatic Discharge**

At the end of a test, the meter automatically discharges the high voltage. The automatic discharge status is reflected on the display. During discharge the beeper will sound and, when completely discharged, the HOLD icon will appear on the display.

## Application-Specific Information

---

### Measuring Power Tools and Small Appliances

For small appliances, connect the GREEN (EARTH) lead to conductors and the RED (LINE) lead to insulating material.

For single or double insulated power tools, one lead should be connected to the device's chuck, blade, etc. and the other lead to one of the AC power cord conductors (test both conductors in turn). Refer to the power tool application diagram below.

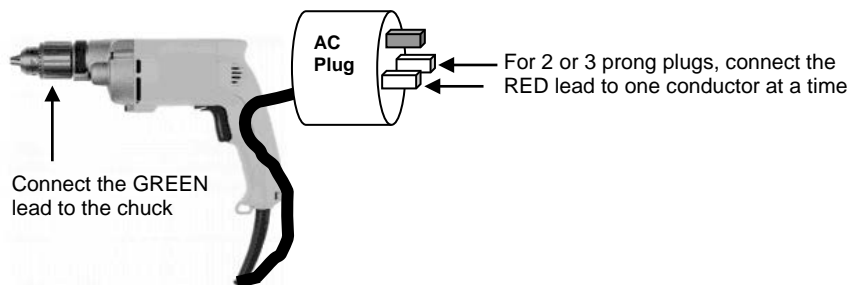

### AC Motor Test

Disconnect the motor from the line by:

- Disconnecting the wires from the motor terminals or,
- Opening the main switch

If the main switch is opened, and the motor has a motor-starter, then the starter must be held in the ON position. With the main switch opened, the measured resistance will include the resistance of the motor wire and all of the other components between the motor and the main switch. If a weakness is indicated, the motor and other components should be checked individually. If the motor is disconnected at the motor terminals, connect the RED lead to the grounded motor housing and the GREEN lead to one of the motor leads.

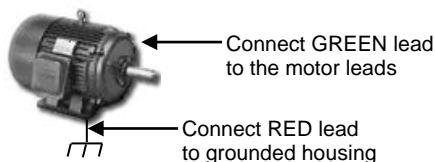

## DC Motor Test

1. Disconnect the motor from the line.
2. To test the brush rigging, field coils, and armature, connect the RED lead to the grounded motor housing and the GREEN lead to the brush on the commutator.
3. If the resistance measurement indicates a weakness, raise the brushes off of the commutator and separately test the armature, field coils, and brush rigging by connecting one lead to each individually, leaving the other connected to the grounded motor housing. This also applies to DC Generators.

## Testing Single Conductor Cables

1. Completely disconnect the cable under test from its source and destination.
2. Connect the test leads to the cable as shown at right.

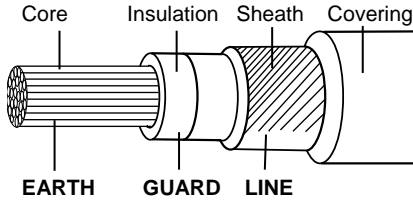

## Testing Multi Conductor Cables

1. Completely disconnect the cable under test from its source and destination.
2. Refer to the diagrams below for three possible tests.

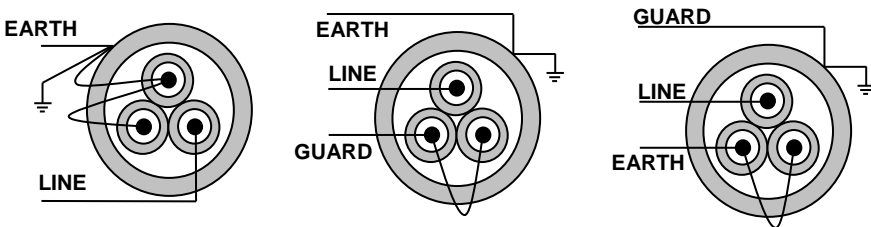

Testing one conductor to all of the conductors	Testing one conductor to earth	One conductor to all minus ground
--	--------------------------------	-----------------------------------

## Transformer Testing

Transformer tests are performed with the transformer completely disconnected from the line and the load. Note that the case ground should not be removed.

The five tests listed below will completely test a single-phase transformer. Note that at least 1 minute should be allowed between each test.

1. High voltage winding to low voltage winding and ground
2. Low voltage winding to high voltage winding and ground
3. High voltage winding to low voltage winding (pictured at right)
4. High voltage winding to ground
5. Low voltage winding to ground

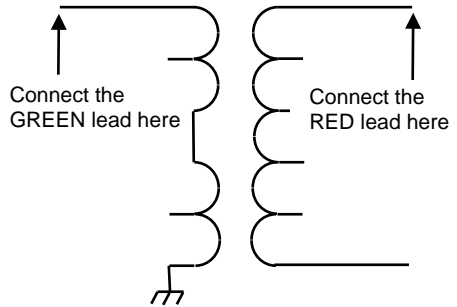

## Notes on Measuring the Resistance of a Contactor or Circuit breaker

A Contactor or Circuit breaker must provide a low resistance path to electricity when closed but should provide a high resistance when open. As they age, their characteristics may deteriorate because of heavy use, operation in a dirty environment, or other factors.

## Unusual Insulation Resistance Measurement Applications

- Special paint or varnish may be used as an insulator on transformers and other electrical applications
- Insulating blankets, suits and gloves can also be tested

## Insulator Measurement Considerations

Insulators may get contaminated over time from a mixture of dust and moisture. Dust and moisture problems lower the resistance of the insulator as this resistance is in parallel with the insulator resistance. It is recommended that the insulator be measured first without the optional guard lead, to verify that the total resistance is high. Should the total resistance not be high enough, the contaminants should be removed or the insulator replaced. Test the dirty insulator for proper resistance by testing with the optional guard lead. Note: If cleaning the insulator is possible, follow the procedure of the manufacturer.

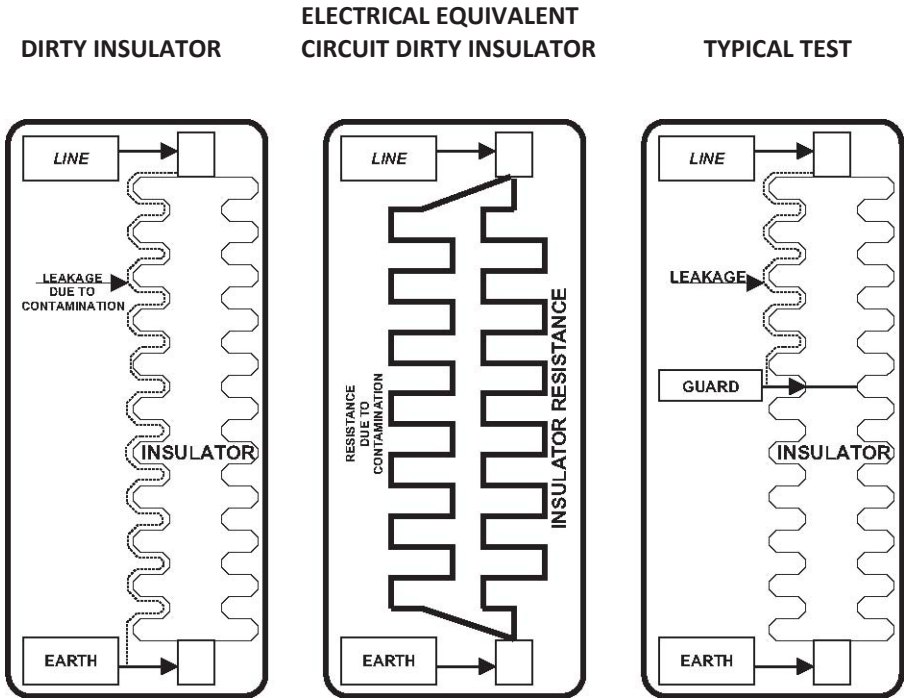

### Notes:

Resistance as a result of contamination can lower the total resistance.  
Cleaning periodically can reduce system power consumption.

# Maintenance

---

## Battery Replacement

When 'REPLACE BATTERY' appears on the display, replace the eight (8) 1.5V 'C' Alkaline batteries.

1. Ensure that the meter is powered down and that the test leads are not connected
2. Close the instrument cover and turn the instrument upside down
3. Remove the screw located on the bottom of the meter
4. Remove the battery compartment cover
5. Replace the eight batteries ensuring proper polarity
6. Affix the rear cover and secure the rear screw



Never dispose of used batteries or rechargeable batteries in household waste.

As consumers, users are legally required to take used batteries to appropriate collection sites, the retail store where the batteries were purchased, or wherever batteries are sold.

Disposal: Do not dispose of this instrument in household waste. The user is obligated to take end-of-life devices to a designated collection point for the disposal of electrical and electronic equipment.

### Other Battery Safety Reminders

- Never dispose of batteries in a fire. Batteries may explode or leak.
- Never mix battery types. Always install new batteries of the same type.

## Cleaning

Periodically wipe the case with a dry cloth. Do not use solvents or abrasives to clean this instrument. Never clean the instrument while it is powered up. Never clean the instrument while the test leads are connected.

**Warning:** To avoid electrical shock or damage to the meter, do not allow water or other liquids inside the housing. Store the instrument in a dry environment.

## Specifications

Display	2 x 16 character alphanumeric multi-function dot matrix (OLED)
Test Voltage Ranges	20 ranges in 500V steps with automatic ranging. Preset buttons for 1KV, 2.5KV, 5KV, and 10KV; CAT III-300V rated
Insulation Resistance Measure Range/Resolution	800k ohms to 500G ohms (Auto-ranging) 1kohm resolution
DAR and PI tests	Calculates Dielectric Absorption Ratio (DAR) Automatically. Calculates Polarization Index (PI) Automatically.
Output Power Limit 1W voltage regulation	Selected Voltage: +20% to -5% of nominal value unless current limited. If output current is too high the voltage will be lowered automatically.
Short-circuit current	0.83 mA @1kV and 2.5kV output 0.62 mA @5kV and 10kV output
Accuracy	± (5% + 2 digits)
Bargraph	Displays voltage ramp, soak, and decay
Automatic discharge	After automatic & manual stop or upon completion of test
External Voltage Alert	Warning of external voltage presence (>500VAC or VDC)
Low battery indicator	"Replace battery" displayed when battery voltage is low
Power source	Eight 1.5V 'C' Alkaline cells
Battery life	40 hours (no load, at 10kV)
Auto Power off	After 10 minutes of inactivity
Enersave™ mode	Shorter test time (10 seconds) to conserves battery energy
Test Leads (silicone)	RED with integrated Blue guard lead, length = 3m (120") Green ground lead, length 127cm (50") Blue Leakage guard lead, length 127cm ( 50")
Operating conditions	0 to 40°C (32 to 104°F); < 80% RH
Altitude	Up to 2000m (7000')
Storage conditions	-10 to 60°C (14 to 140°F); < 80% RH
Dimensions	330 x 260 x 160mm (13 x 10.2 x 6.3")
Weight	3.6kg. (7.9 lbs.)

### Complies with:

- IEC/EN 61010-1:2001
- EN 61326-1, EN55011+A1+A2, En 61000-4-2+A1+A2, En 6100-4-3+A1
- En 6100-4-8+A1

**Copyright © 2013-2017 FLIR Systems, Inc.**

All rights reserved including the right of reproduction in whole or in part in any form  
ISO-9001 Certified

**www.extech.com**