



GaAs HEMT MMIC LOW NOISE AMPLIFIER, 14 - 27 GHz

Typical Applications

This HMC504LC4B is ideal for:

- Point-to-Point Radios
- Point-to-Multi-Point Radios
- Military & Space
- Test Instrumentation

Features

- Noise Figure: 2.2 dB @ 20 GHz
- Gain: 19 dB
- P1dB Output Power: +17 dBm
- Supply Voltage: +4V @ 90mA
- Output IP3: +26 dBm
- 50 Ohm matched Input/Output
- 24 Lead 4x4mm SMT Package: 16mm²

Functional Diagram

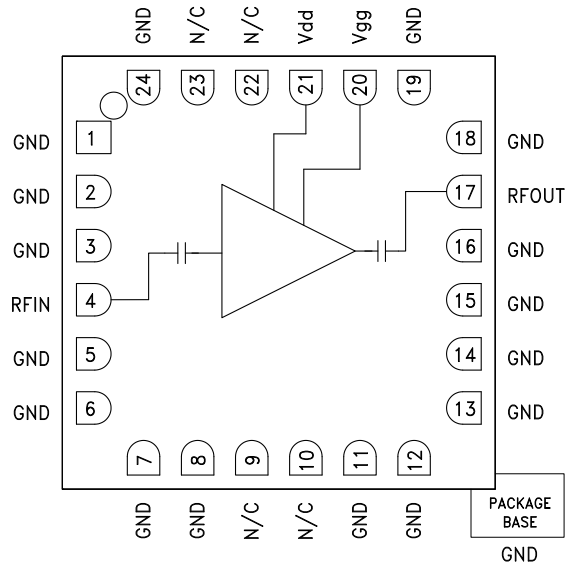

General Description

The HMC504LC4B is a GaAs MMIC Low Noise Wideband Amplifier housed in a leadless 4x4 mm ceramic surface mount package. The amplifier operates between 14 and 27 GHz, providing up to 19 dB of small signal gain, 2.2 dB noise figure, and output IP3 of +26 dBm, while requiring only 90 mA from a +4V supply. The P1dB output power of up to +17 dBm enables the LNA to function as a LO driver for balanced, I/Q or image reject mixers. The HMC504LC4B also features I/Os that are DC blocked and internally matched to 50 Ohms, making it ideal for high capacity microwave radios or VSAT applications. This versatile LNA is also available in die form as the HMC-ALH476.

Electrical Specifications, $T_A = +25^\circ\text{C}$, $V_{dd} = +4\text{V}$, $I_{dd} = 90\text{mA}$ ^[2]

Parameter	Min.	Typ.	Max.	Min.	Typ.	Max.	Min.	Typ.	Max.	Units
Frequency Range	14 - 20			20 - 24			24 - 27			GHz
Gain ^[1]	16.5	19		16	18.5		14	17		dB
Gain Variation over Temperature		0.015			0.017			0.018		dB / °C
Noise Figure ^[1]		2.2	3		2.5	4.2		4.5	6	dB
Input Return Loss		15			9			7		dB
Output Return Loss		15			12			9.5		dB
Output Power for 1 dB Compression ^[1]		15			16.5			17		dBm
Saturated Output Power (P _{sat}) ^[1]		19.5			19.5			19		dBm
Output Third Order Intercept (IP3)		24.5			25.5			26		dBm
Supply Current (I _{dd}) (V _{dd} = 4V, V _{gg} = -0.3V Typ.)		90			90			90		mA

[1] Board loss subtracted out for gain, power and noise figure measurement

[2] Adjust V_{gg} between -1 to 0.3V to achieve I_{dd} = 90mA

HMC504* PRODUCT PAGE QUICK LINKS

Last Content Update: 02/23/2017

COMPARABLE PARTS

View a parametric search of comparable parts.

EVALUATION KITS

- HMC504LC4B Evaluation Board

DOCUMENTATION

Application Notes

- AN-1363: Meeting Biasing Requirements of Externally Biased RF/Microwave Amplifiers with Active Bias Controllers
- Broadband Biasing of Amplifiers General Application Note
- MMIC Amplifier Biasing Procedure Application Note
- Thermal Management for Surface Mount Components General Application Note

Data Sheet

- HMC504 Data Sheet

TOOLS AND SIMULATIONS

- HMC504 S-Parameter

REFERENCE MATERIALS

Quality Documentation

- Package/Assembly Qualification Test Report: LC4, LC4B (QTR: 2014-00380 REV: 01)
- Package/Assembly Qualification Test Report: Plastic Encapsulated QFN (QTR: 05006 REV: 02)

DESIGN RESOURCES

- HMC504 Material Declaration
- PCN-PDN Information
- Quality And Reliability
- Symbols and Footprints

DISCUSSIONS

View all HMC504 EngineerZone Discussions.

SAMPLE AND BUY

Visit the product page to see pricing options.

TECHNICAL SUPPORT

Submit a technical question or find your regional support number.

DOCUMENT FEEDBACK

Submit feedback for this data sheet.



**GaAs HEMT MMIC LOW NOISE
AMPLIFIER, 14 - 27 GHz**

Broadband Gain & Return Loss [1]

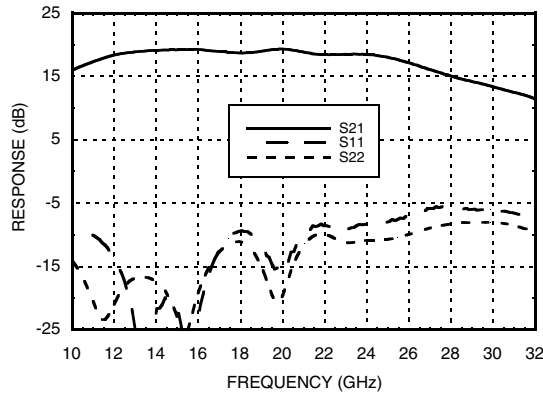

Gain vs. Temperature [1]

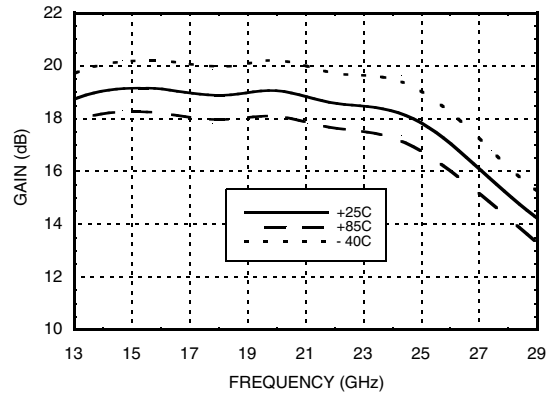

Input Return Loss vs. Temperature

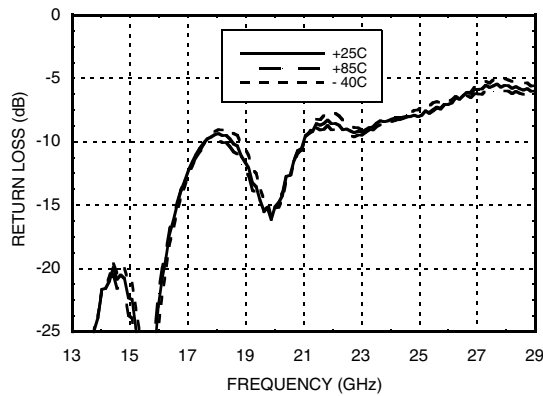

Output Return Loss vs. Temperature

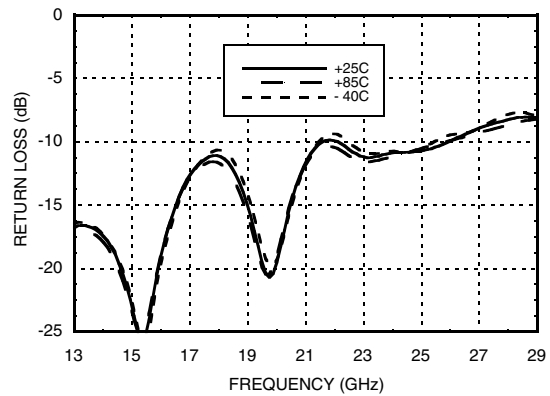

Noise Figure vs. Temperature [1]

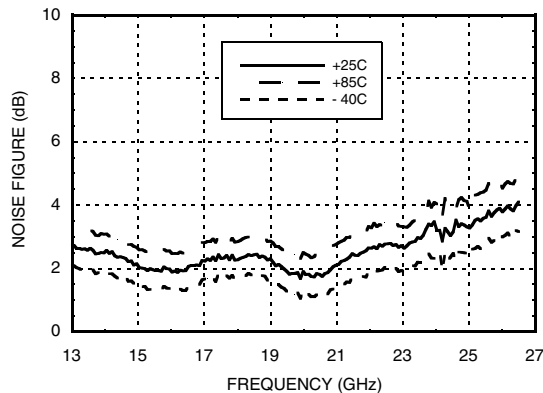

Output IP3 vs. Temperature

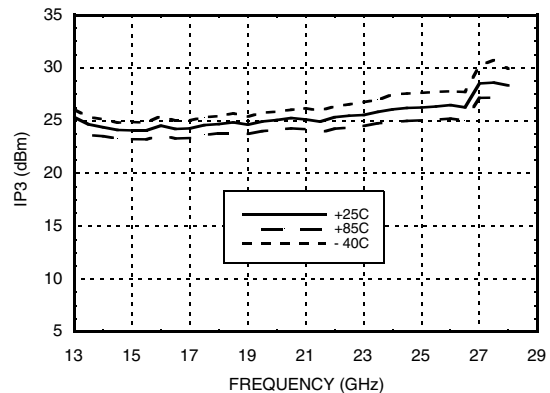

[1] Board loss subtracted out for gain, power and noise figure measurement



**GaAs HEMT MMIC LOW NOISE
AMPLIFIER, 14 - 27 GHz**

P1dB vs. Temperature [1]

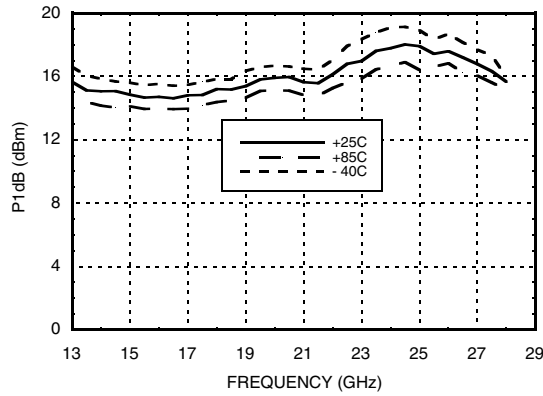

Psat vs. Temperature [1]

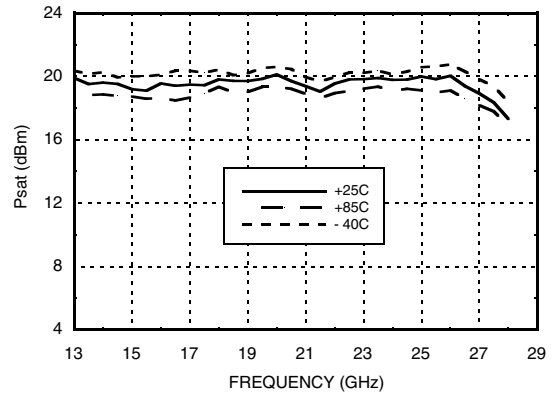

Reverse Isolation vs. Temperature

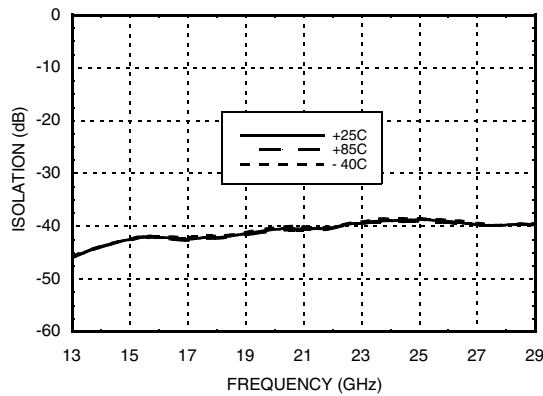

Power Compression @ 21 GHz [1]

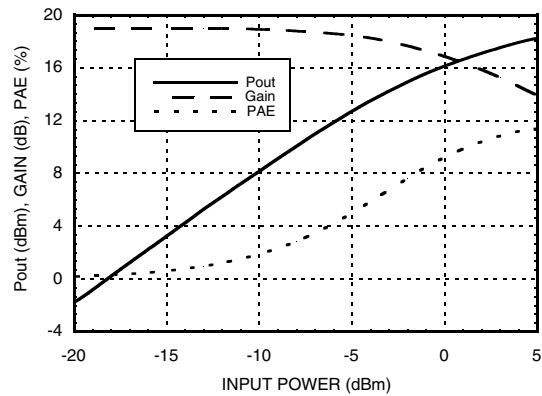

**Gain, Noise Figure & Power vs.
Supply Voltage @ 21 GHz [1]**

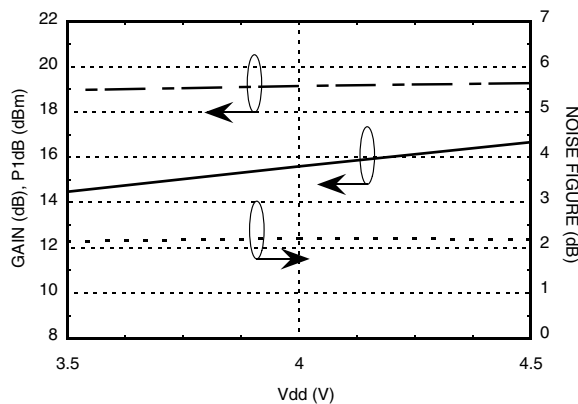

[1] Board loss subtracted out for gain, power and noise figure measurement



GaAs HEMT MMIC LOW NOISE AMPLIFIER, 14 - 27 GHz

Absolute Maximum Ratings

Drain Bias Voltage	+4.5V
RF Input Power	+6 dBm
Gate Bias Voltage	-1 to 0.3V
Channel Temperature	180 °C
Continuous P _{diss} (T = 85 °C) (derate 20 mW/°C above 85 °C)	1.9 W
Thermal Resistance (Channel to die bottom)	50 °C/W
Storage Temperature	-65 to +150 °C
Operating Temperature	-55 to +85 °C



ELECTROSTATIC SENSITIVE DEVICE
OBSERVE HANDLING PRECAUTIONS

Outline Drawing

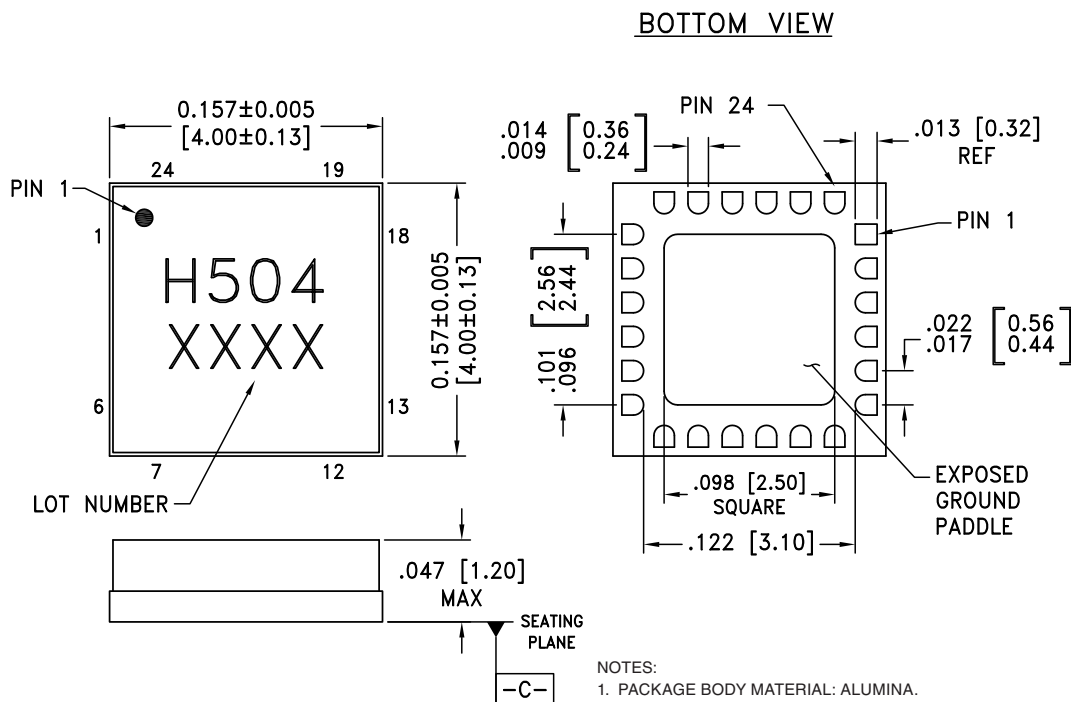

NOTES:

1. PACKAGE BODY MATERIAL: ALUMINA.
2. LEAD AND GROUND PADDLE PLATING: GOLD FLASH OVER NICKEL.
3. DIMENSIONS ARE IN INCHES (MILLIMETERS).
4. LEAD SPACING TOLERANCE IS NON-CUMULATIVE.
5. PACKAGE WARP SHALL NOT EXCEED 0.05MM DATUM -C-
6. ALL GROUND LEADS AND GROUND PADDLE MUST BE SOLDERED TO PCB RF GROUND.

Package Information

Part Number	Package Body Material	Lead Finish	MSL Rating	Package Marking ^[2]
HMC504LC4B	Alumina, White	Gold over Nickel	MSL3 ^[1]	H504 XXXX

[1] Max peak reflow temperature of 260 °C

[2] 4-Digit lot number XXXX



**GaAs HEMT MMIC LOW NOISE
AMPLIFIER, 14 - 27 GHz**

Pin Descriptions

Pin Number	Function	Description	Interface Schematic
1 - 3, 5 - 8, 11 - 16, 18, 19, 24	GND	Package bottom has exposed metal paddle that must be connected to RF/DC ground.	
4	RFIN	This pad is AC coupled and matched to 50 Ohms.	
17	RFOUT	This pad is AC coupled and matched to 50 Ohms.	
20	Vgg	Gate control for amplifier. Please follow "MMIC Amplifier Biasing Procedure" application note. See assembly for required external components.	
21	Vdd	Power Supply Voltage for the amplifier. See assembly for required external components.	

Application Circuit

Component	Value
C1, C2	100 pF
C3, C4	10,000 pF
C5, C6	4.7 μF

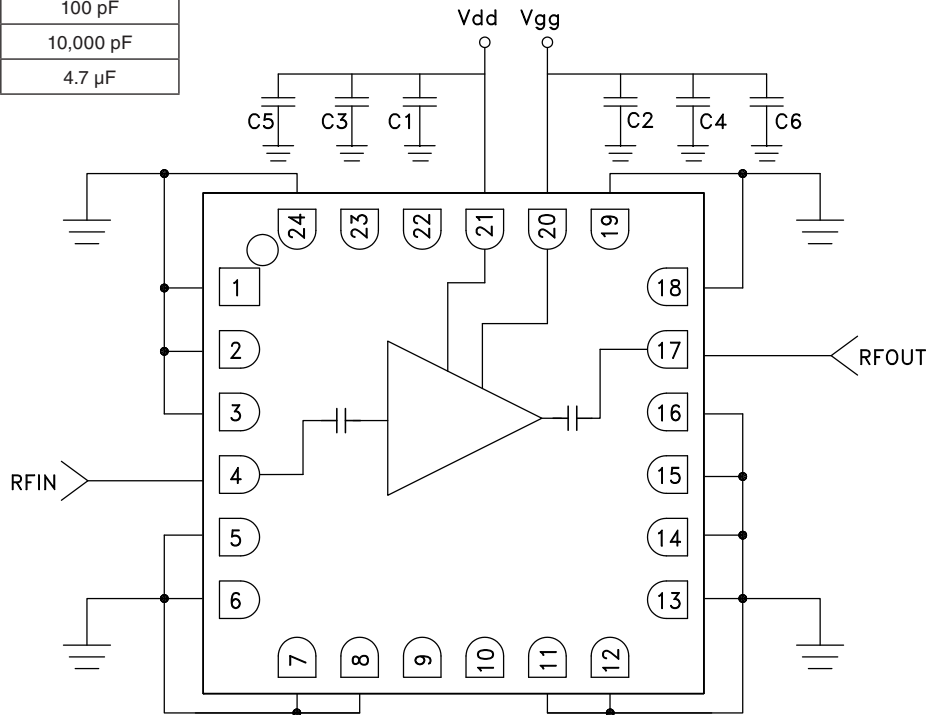

Information furnished by Analog Devices is believed to be accurate and reliable. However, no responsibility is assumed by Analog Devices for its use, nor for any infringements of patents or other rights of third parties that may result from its use. Specifications subject to change without notice. No license is granted by implication or otherwise under any patent or patent rights of Analog Devices. Trademarks and registered trademarks are the property of their respective owners.

For price, delivery, and to place orders: Analog Devices, Inc., One Technology Way, P.O. Box 9106, Norwood, MA 02062-9106 Phone: 781-329-4700 • Order online at www.analog.com Application Support: Phone: 1-800-ANALOG-D

GaAs HEMT MMIC LOW NOISE AMPLIFIER, 14 - 27 GHz



Evaluation PCB

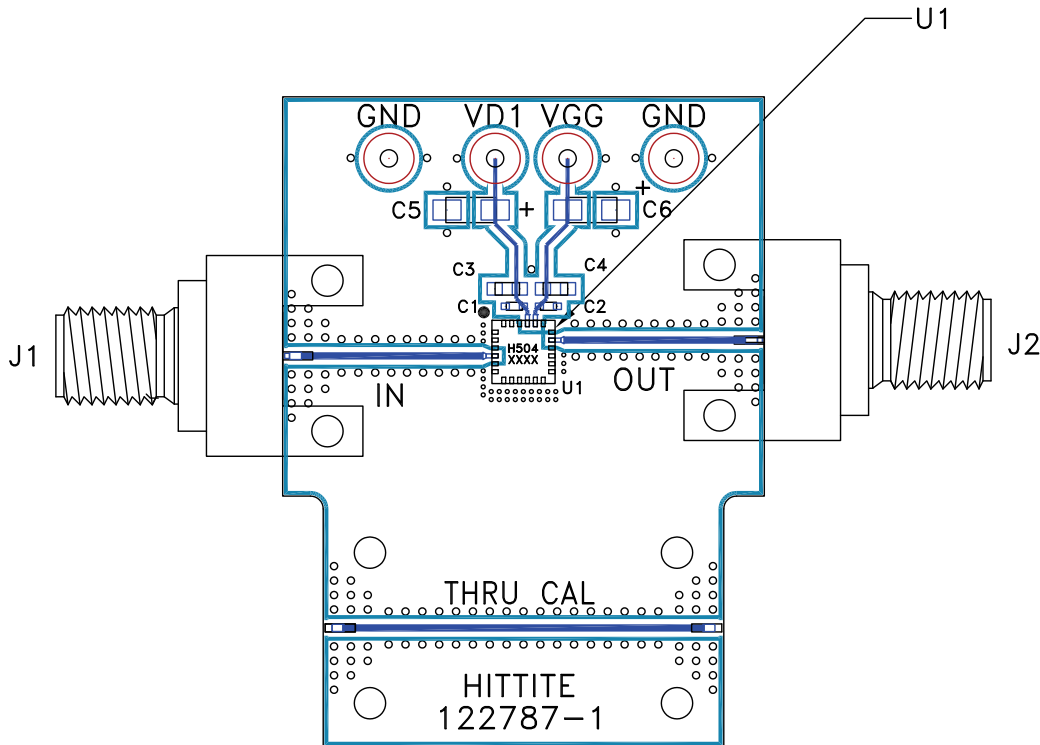

List of Materials for Evaluation PCB 122789 [1]

Item	Description
J1, J2	2.92mm PCB mount K-Connector
J3 - J6	DC Pin
C1, C2	100 pF Capacitor, 0402 Pkg.
C3, C4	10,000pF Capacitor, 0603 Pkg.
C5, C6	4.7 μF Capacitor, Tantalum
U1	HMC504LC4B Amplifier
PCB [2]	122787 Evaluation PCB [3]

[1] Reference this number when ordering complete evaluation PCB

[2] Circuit Board Material: Rogers 4350 or Arlon 25FR

[3] Due to the very high frequency operation of this product a custom LC4B PCB footprint and solder stencil are required for this design. Performance shown in this data sheet was produced using this custom footprint. DO NOT USE Hittite's standard LC4B footprint. Please contact Applications for details.

The circuit board used in this application should use RF circuit design techniques. Signal lines should have 50 Ohm impedance while the package ground leads and exposed paddle should be connected directly to the ground plane similar to that shown. A sufficient number of via holes should be used to connect the top and bottom ground planes. The evaluation board should be mounted to an appropriate heat sink. The evaluation circuit board shown is available from Hittite upon request.