

3950X SERIES
3.50mm HEADERS

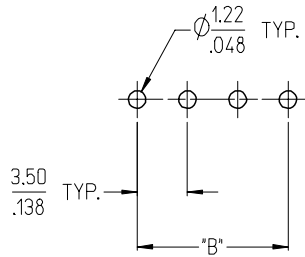

3952X & 3954X SERIES
5.00mm HEADERS
5.00mm 10 AMP FIXED

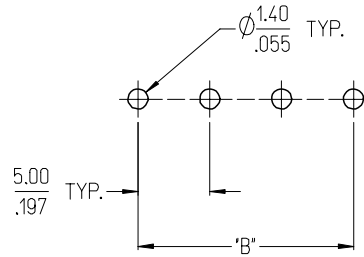

3953X SERIES
5.08mm HEADERS

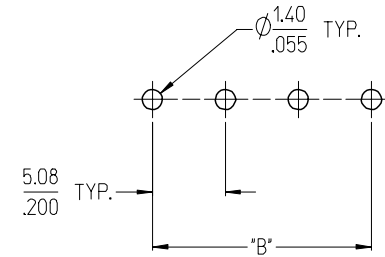

3951X SERIES
3.81mm HEADERS

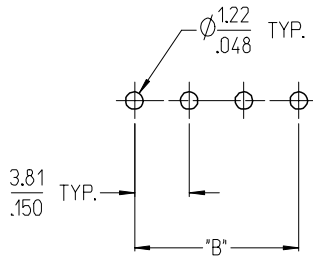

3954X SERIES
5.00mm 15 AMP FIXED

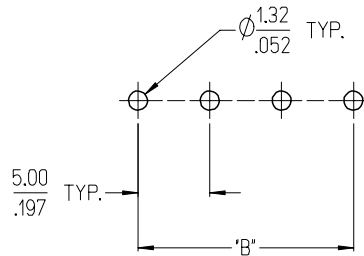

3954X SERIES
5.08mm 15 AMP FIXED

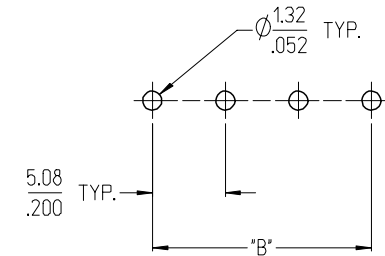

NOTES:

- REFER TO INDIVIDUAL PRODUCT SALES DRAWINGS FOR "B" DIMENSION.
- DOES NOT APPLY TO DUAL LEVEL HEADERS, SERIES 39528 AND 39538.
- TYP. = TYPICAL.

INITIAL RELEASE	EC NO: ETC2007-0096
DRWN: CLYORK	2006/10/02
CHKD: JMACNEIL	2006/10/04
APPR: JMACNEIL	2006/10/04
REV	DESCRIPTION
A	

QUALITY SYMBOLS
▽=0
▽=0

GENERAL TOLERANCES (UNLESS SPECIFIED)	
	mm INCH
4 PLACES	± .005 ± .005
3 PLACES	± .01 ± .01
2 PLACES	± .02 ± .02
1 PLACE	± .03 ± .03
ANGULAR ± 2 °	
DRAFT WHERE APPLICABLE MUST REMAIN WITHIN DIMENSIONS	

DIMENSION STYLE	
MM/IN	
DRAWN BY	DATE
C. YORK	2006/08/25
CHECKED BY	DATE
J. MACNEIL	2006/08/25
APPROVED BY	DATE
J. MACNEIL	2006/08/25
MATERIAL NO.	
--	

SCALE	DESIGN UNITS	THIRD ANGLE PROJECTION
3:1	INCH	
TITLE		
RECOMMENDED PCB LAYOUT FOR ESE TERMINAL BLOCKS		
MOLEX INCORPORATED		
DOCUMENT NO.	SHEET NO.	
SD-39501-002	1 OF 1	
THIS DRAWING CONTAINS INFORMATION THAT IS PROPRIETARY TO MOLEX INCORPORATED AND SHOULD NOT BE USED WITHOUT WRITTEN PERMISSION		

10 9 8 7 6 5 4 3 2 1

F

E

D

C

B

A

F

E

D

C

B

A

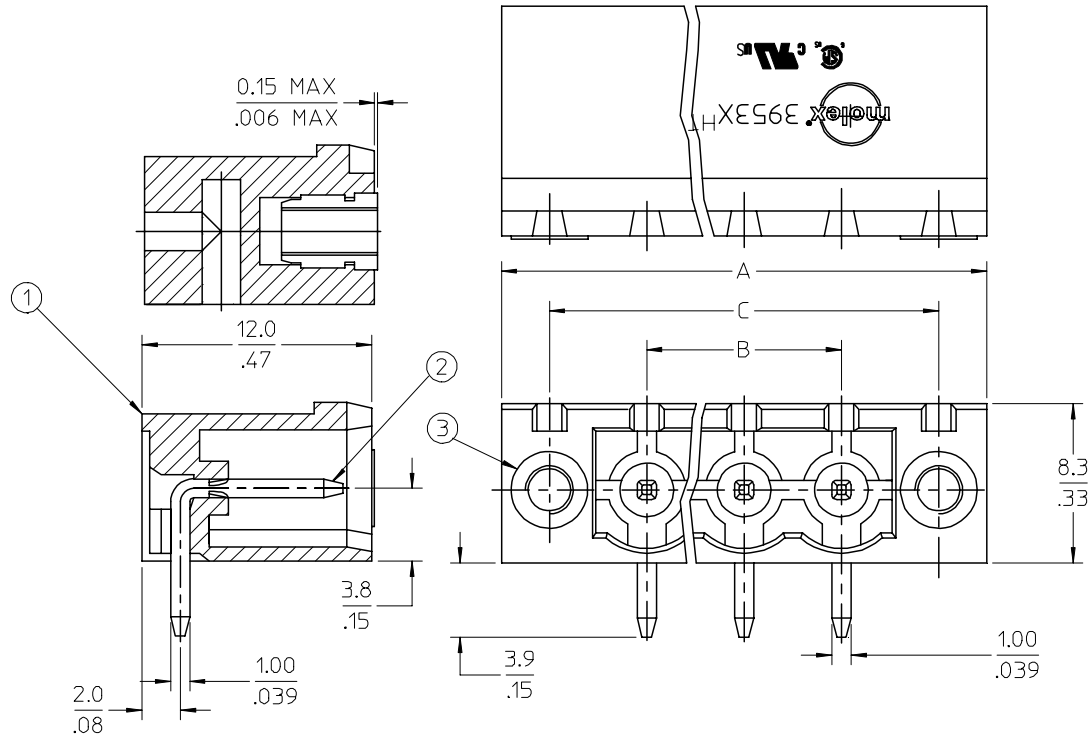
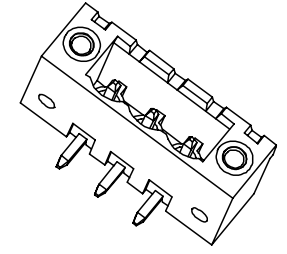

SPECIFICATIONS:

1. Material:
 - (1). Body: PA46
 - (2). Pin: Brass
 - (3). Threaded insert: Brass
2. Wire range: N/A
3. Electrical rating: 300V, 15A.
4. Wire strip length: N/A
5. Operating temperature: -40C to +140C.
6. Max torque: N/A
7. Insulation resistance: DC 500V, 500M.
8. Dielectric withstand: AC 2500V for 1 minute.
9. Breakdown voltage: 4000V.
10. $A = (B + 15.0\text{mm})$
11. $B = (N - 1) \times P$
13. $C = (B + 10\text{mm})$
12. P (PITCH) = 5.0mm (.197").
13. N = Number of positions available 2 through 24.

ENTER DESCRIPTION EC NO: NEO2006-0310 DRWNL: LROTHAUS 2006/01/09 CHKDC: YORK 2006/01/09 APPR: JPAMLIK 2006/01/10	DESCRIPTION QUALITY SYMBOLS ▽=0 ▽=0	GENERAL TOLERANCES (UNLESS SPECIFIED)		DIMENSION STYLE MM/IN		SCALE 4:1	DESIGN UNITS INCH	THIRD ANGLE PROJECTION		
		4 PLACES ± --- ±.0015	3 PLACES ±0.038 ±.005	DRAWN BY LROTHAUS	DATE 12/6/05	TITLE 5.0MM, EURO HEADER, RIGHT ANGLE, HI-TEMP MOUNTING				
		2 PLACES ±0.13 ±.01	1 PLACE ±0.3 ± ---	CHECKED BY C. YORK	DATE 01/06/06					
		ANGULAR ± 2 °		APPROVED BY DATE		MOLEX INCORPORATED				
DRAFT WHERE APPLICABLE MUST REMAIN WITHIN DIMENSIONS		MATERIAL NO. SEE CHART		DOCUMENT NO. SD-39526-001			SHEET NO. 1 OF 1			

9 8 7 6 5 4 3 2 1

10 9 8 7 6 5 4 3 2 1

Description	Circuit size	Material Numbers											Dimensional Information						
		Black						Green					Dim. A		Dim. B		Dim. C		
		100% Tin			30 u" Gold			100% Tin			30 u" Gold		mm	inch	mm	inch	mm	inch	
		Printing Options			Printing Options			Printing Options			Printing Options								
None	10A	11A	None	10A	11A	None	10A	11A	None	10A	11A	None	10A	11A					
5.0mm, Euro Header, Right Angle, Mounting Ends, High Temp	2	395264002	395264102	395264202	395264502	395264602	395264702	395269002	395269102	395269202	395269502	395269602	395269702	20.00	0.787	5.00	0.197	15.00	0.591
5.0mm, Euro Header, Right Angle, Mounting Ends, High Temp	3	395264003	395264103	395264203	395264503	395264603	395264703	395269003	395269103	395269203	395269503	395269603	395269703	25.00	0.984	10.00	0.394	20.00	0.787
5.0mm, Euro Header, Right Angle, Mounting Ends, High Temp	4	395264004	395264104	395264204	395264504	395264604	395264704	395269004	395269104	395269204	395269504	395269604	395269704	30.00	1.181	15.00	0.591	25.00	0.984
5.0mm, Euro Header, Right Angle, Mounting Ends, High Temp	5	395264005	395264105	395264205	395264505	395264605	395264705	395269005	395269105	395269205	395269505	395269605	395269705	35.00	1.378	20.00	0.787	30.00	1.181
5.0mm, Euro Header, Right Angle, Mounting Ends, High Temp	6	395264006	395264106	395264206	395264506	395264606	395264706	395269006	395269106	395269206	395269506	395269606	395269706	40.00	1.575	25.00	0.984	35.00	1.378
5.0mm, Euro Header, Right Angle, Mounting Ends, High Temp	7	395264007	395264107	395264207	395264507	395264607	395264707	395269007	395269107	395269207	395269507	395269607	395269707	45.00	1.772	30.00	1.181	40.00	1.575
5.0mm, Euro Header, Right Angle, Mounting Ends, High Temp	8	395264008	395264108	395264208	395264508	395264608	395264708	395269008	395269108	395269208	395269508	395269608	395269708	50.00	1.969	35.00	1.378	45.00	1.772
5.0mm, Euro Header, Right Angle, Mounting Ends, High Temp	9	395264009	395264109	395264209	395264509	395264609	395264709	395269009	395269109	395269209	395269509	395269609	395269709	55.00	2.165	40.00	1.575	50.00	1.969
5.0mm, Euro Header, Right Angle, Mounting Ends, High Temp	10	395264010	395264110	395264210	395264510	395264610	395264710	395269010	395269110	395269210	395269510	395269610	395269710	60.00	2.362	45.00	1.772	55.00	2.165
5.0mm, Euro Header, Right Angle, Mounting Ends, High Temp	11	395264011	395264111	395264211	395264511	395264611	395264711	395269011	395269111	395269211	395269511	395269611	395269711	65.00	2.559	50.00	1.969	60.00	2.362
5.0mm, Euro Header, Right Angle, Mounting Ends, High Temp	12	395264012	395264112	395264212	395264512	395264612	395264712	395269012	395269112	395269212	395269512	395269612	395269712	70.00	2.756	55.00	2.165	65.00	2.559
5.0mm, Euro Header, Right Angle, Mounting Ends, High Temp	13	395264013	395264113	395264213	395264513	395264613	395264713	395269013	395269113	395269213	395269513	395269613	395269713	75.00	2.953	60.00	2.362	70.00	2.756
5.0mm, Euro Header, Right Angle, Mounting Ends, High Temp	14	395264014	395264114	395264214	395264514	395264614	395264714	395269014	395269114	395269214	395269514	395269614	395269714	80.00	3.150	65.00	2.559	75.00	2.953
5.0mm, Euro Header, Right Angle, Mounting Ends, High Temp	15	395264015	395264115	395264215	395264515	395264615	395264715	395269015	395269115	395269215	395269515	395269615	395269715	85.00	3.346	70.00	2.756	80.00	3.150
5.0mm, Euro Header, Right Angle, Mounting Ends, High Temp	16	395264016	395264116	395264216	395264516	395264616	395264716	395269016	395269116	395269216	395269516	395269616	395269716	90.00	3.543	75.00	2.953	85.00	3.346
5.0mm, Euro Header, Right Angle, Mounting Ends, High Temp	17	395264017	395264117	395264217	395264517	395264617	395264717	395269017	395269117	395269217	395269517	395269617	395269717	95.00	3.740	80.00	3.150	90.00	3.543
5.0mm, Euro Header, Right Angle, Mounting Ends, High Temp	18	395264018	395264118	395264218	395264518	395264618	395264718	395269018	395269118	395269218	395269518	395269618	395269718	100.00	3.937	85.00	3.346	95.00	3.740
5.0mm, Euro Header, Right Angle, Mounting Ends, High Temp	19	395264019	395264119	395264219	395264519	395264619	395264719	395269019	395269119	395269219	395269519	395269619	395269719	105.00	4.134	90.00	3.543	100.00	3.937
5.0mm, Euro Header, Right Angle, Mounting Ends, High Temp	20	395264020	395264120	395264220	395264520	395264620	395264720	395269020	395269120	395269220	395269520	395269620	395269720	110.00	4.331	95.00	3.740	105.00	4.134
5.0mm, Euro Header, Right Angle, Mounting Ends, High Temp	21	395264021	395264121	395264221	395264521	395264621	395264721	395269021	395269121	395269221	395269521	395269621	395269721	115.00	4.528	100.00	3.937	110.00	4.331
5.0mm, Euro Header, Right Angle, Mounting Ends, High Temp	22	395264022	395264122	395264222	395264522	395264622	395264722	395269022	395269122	395269222	395269522	395269622	395269722	120.00	4.724	105.00	4.134	115.00	4.528
5.0mm, Euro Header, Right Angle, Mounting Ends, High Temp	23	395264023	395264123	395264223	395264523	395264623	395264723	395269023	395269123	395269223	395269523	395269623	395269723	125.00	4.921	110.00	4.331	120.00	4.724
5.0mm, Euro Header, Right Angle, Mounting Ends, High Temp	24	395264024	395264124	395264224	395264524	395264624	395264724	395269024	395269124	395269224	395269524	395269624	395269724	130.00	5.118	115.00	4.528	125.00	4.921

SEE SHEET 1 EC NO: NEC2006-0310 DRWN: LROTHAUS 2006/01/09 CHKD: CYORK 2006/01/09 APPR: JFAMLIK 2006/01/10	QUALITY SYMBOLS ▽=0 ▽=0	GENERAL TOLERANCES (UNLESS SPECIFIED)		DIMENSION STYLE MM/IN		SCALE 4:1	DESIGN UNITS INCH	THIRD ANGLE PROJECTION
		4 PLACES ± --- ±.0015	3 PLACES ± 0.038 ±.005	DRAWN BY LROTHAUS	DATE 12/6/05	TITLE 5.0MM, EURO HEADER, RIGH ANGLE, HI-TEMP MOUNTING		
		2 PLACES ± 0.13 ±.01	1 PLACE ± 0.3 ± ---	CHECKED BY C. YORK	DATE 01/04/06			
		ANGULAR ± 2 °		APPROVED BY	DATE			
DRAFT WHERE APPLICABLE MUST REMAIN WITHIN DIMENSIONS		MATERIAL NO. SEE CHART	DOCUMENT NO. SD-39526-001	SHEET NO. 2 OF 2				
THIS DRAWING CONTAINS INFORMATION THAT IS PROPRIETARY TO MOLEX INCORPORATED AND SHOULD NOT BE USED WITHOUT WRITTEN PERMISSION								

9 8 7 6 5 4 3 2 1