

**ebm-papst St. Georgen GmbH & Co. KG**

Hermann-Papst-Str. 1

D-78112 St. Georgen

Phone +49 (0) 7724 81-0

Fax +49 (0) 7724 81-1309

info2@de.ebmpapst.com

www.ebmpapst.com

Nominal data

Type	7114 N	
Nominal voltage	VDC	24
Nominal voltage range	VDC	12 .. 30
Speed (rpm)	min ⁻¹	2850
Power consumption	W	12.0
Min. ambient temperature	°C	-25
Max. ambient temperature	°C	72
Air flow	m ³ /h	308
Sound power level	B	6.2
Sound pressure level	dB(A)	53

ml = Max. load · me = Max. efficiency · fa = Free air · cs = Customer specification · ce = Customer equipment
 Subject to change



Technical description

General description	* Power consumption when wide open; these values may be considerably higher at the operating point.
Weight	0.620 kg
Dimensions	Ø 150 x 38 mm
Impeller material	Sheet steel, painted black
Housing material	Die-cast aluminum
Airflow direction	Intake over struts
Direction of rotation	Counterclockwise, viewed toward rotor
Storage	Ball bearing
Service life L10 at 40 °C	80000 h
Service life L10 at maximum temperature	37500 h
Cable	Leads AWG 22, TR 64, stripped and tin-plated.
Motor protection	Protection against reverse polarity and blocked rotor.
Locked-rotor protection	Electronic locked-rotor protection
Approval	VDE, CSA, UL, CE
Option	Speed signal

Product drawing

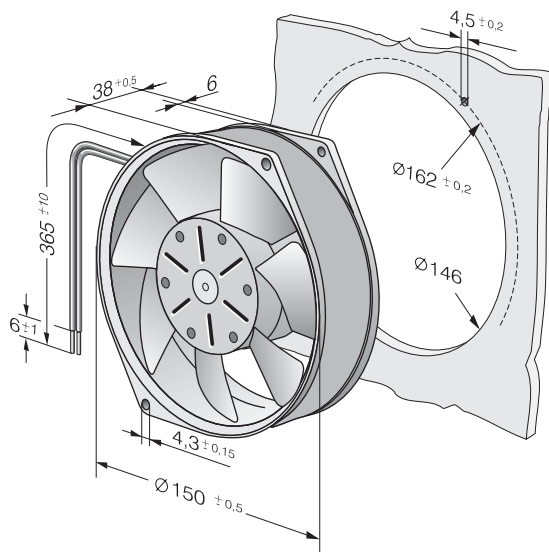

Curves: Air performance

