

LTC7820EUFD High Efficiency, Charge Pump DC/DC Converter

DESCRIPTION

Demonstration circuit 2543A is a high efficiency, high density, open loop charge pump (inductorless) DC/DC converter. This demo board is a voltage divider which achieves a 2:1 step-down ratio from an input voltage from 36V to 60V. The output voltage is a fixed ratio of half of the input voltage ($V_{IN}/2$) and can supply a 10A load current. This demo board has the option to deliver a 20A maximum load with the addition of 15 chip capacitors. See Figures 8 and 10 for the details.

The DC2543A provides a very high efficiency solution of 98.7% when converting 48V_{IN} to 24V_{OUT} at 10A as shown in Figure 3. When configured for a 20A output, an efficiency of up to 98.4% is achievable for a 48V_{IN} to 24V_{OUT} at 20A as shown in Figure 8.

The demo board features the [LTC®7820](#), a fixed ratio high voltage high power switched capacitor/charge pump controller in a 4mm × 5mm QFN package. Please see LTC7820 data sheet for more detailed information.

The DC2543A needs to be powered on with no load current or a very small load current (less than 50mA) with the default setup. Large load current can be applied after V_O is established. The board offers a disconnect FET option which is controlled by the LTC7820 FAULT pin to disconnect the load during startup as shown in the schematic. Please refer to “Voltage Divider Prebalance Before Switching” section in the LTC7820 data sheet for more details regarding the startup of the voltage divider. The board also features some protection functions such as overcurrent and thermal shutdown to make it a reliable solution.

Design files for this circuit board are available at <http://www.linear.com/demo/DC2543A>

LT, LT, LTC, LTM, Linear Technology and the Linear logo are registered trademarks of Analog Devices, Inc. All other trademarks are the property of their respective owners.

PERFORMANCE SUMMARY Specifications are at T_A = 25°C

PARAMETER	CONDITION	VALUE
Input Voltage Range		36V to 60V
Output Voltage, V _{OUT}	V _{IN} = 36 to 60V, I _{OUT} = 0A to 10A	V _{IN} /2
Maximum Output Current, I _{OUT}	V _{IN} = 36 to 60V, V _{OUT} = V _{IN} /2	10A
Typical Efficiency	V _{IN} = 48V, V _{OUT} = 24V, I _{OUT} = 10A	98.7%
Peak Efficiency	V _{IN} = 48V, V _{OUT} = 24V	99%
Switching Frequency		200kHz

QUICK START PROCEDURE

Demonstration circuit 2543A is easy to set up to evaluate the performance of the LTC7820. Refer to Figure 1 for the proper measurement equipment setup and follow the procedure below.

1. With power off, connect the input power supply to V_{IN} (36V to 60V) and GND (input return).
2. Connect the output loads between V_{OUT} and GND (Initial load: no load). Refer to Figure 1.
3. Connect the DVMs to the input and output.
4. Check the default jumper/switch position: SW1 (RUN): OFF; JP2 (BIAS): ON.
5. Turn on the input power supply and adjust voltage to 48V.

NOTE: Make sure that the input voltage does not exceed 60V.
6. Turn on the switches: SW1: ON.
7. Check for the proper output voltages from $V_{O_SNS^+}$ to $V_{O_SNS^-}$.

8. Once the proper output voltage is established, adjust the loads within the operating range and measure the efficiency, output ripple voltage and other parameters.
9. After completing all tests, adjust the load to 0A, power off the input power supply.

Notes:

1. When measuring the output or input voltage ripple, do not use the long ground lead on the oscilloscope probe. See Figure 3 for the proper scope probe technique. Short, stiff leads need to be soldered to the (+) and (-) terminals of an output capacitor. The probe's ground ring needs to touch the (-) lead and the probe tip needs to touch the (+) lead.
2. When doing the load step test with the on-board dynamic load circuit, please make sure the load step-up pulse duty cycle does not exceed 2% and the pulse duration is less than 500 μ s so that the temperature of the MOSFETs Q9, Q23 in the dynamic load circuit stay in the safe region. Instead of using the on-board dynamic load circuit, an electric load can also be used for the load step test, which does not have the 2% maximum duty cycle limit for the load step.

QUICK START PROCEDURE

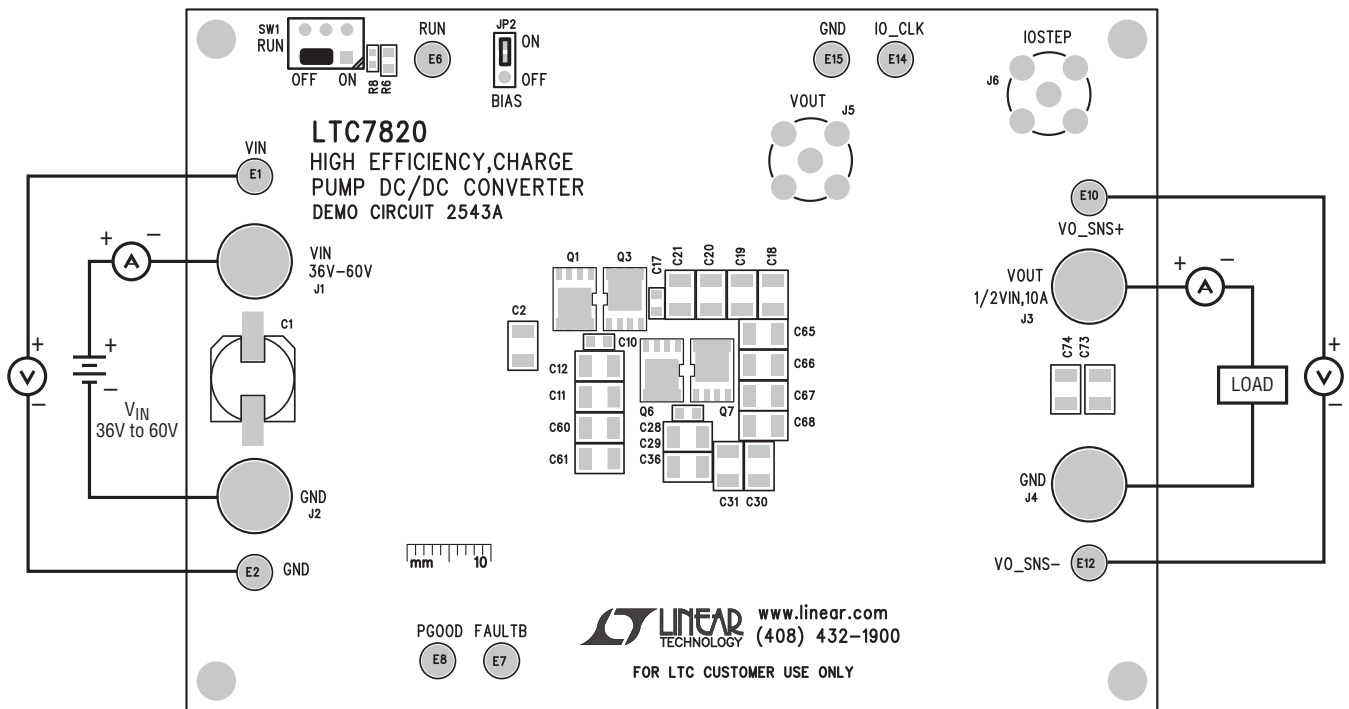

Figure 1. Proper Measurement Equipment Setup

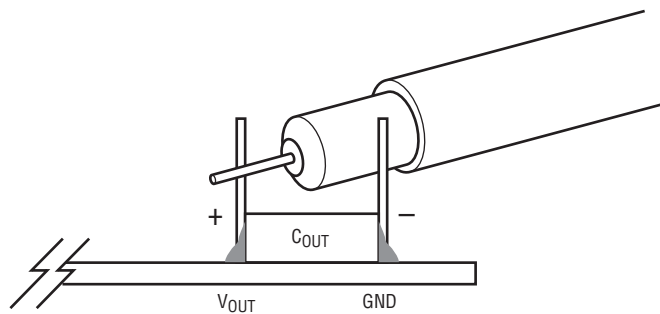

Figure 2. Measuring Output Voltage Ripple

QUICK START PROCEDURE

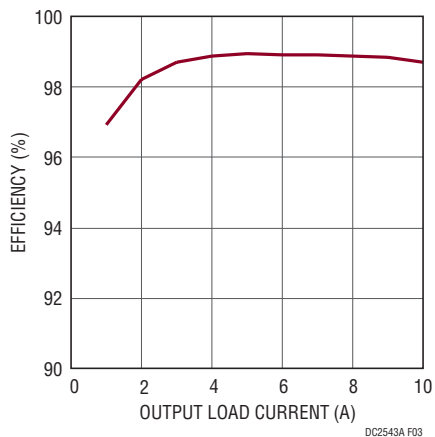

Figure 3. Efficiency vs Load Current at $V_{IN} = 48V$, $V_{OUT} = 24V$, $f_{SW} = 200kHz$

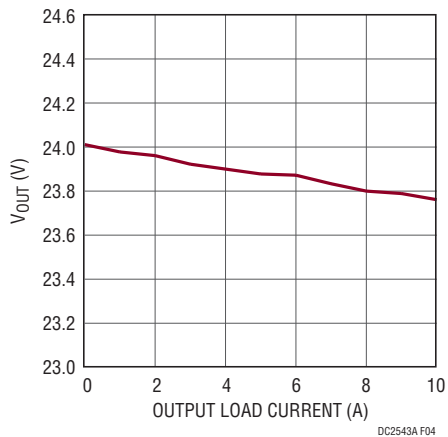

Figure 4. Load Regulation for 10A Design at $V_{IN} = 48V$, $V_{OUT} = 24V$, $f_{SW} = 200kHz$

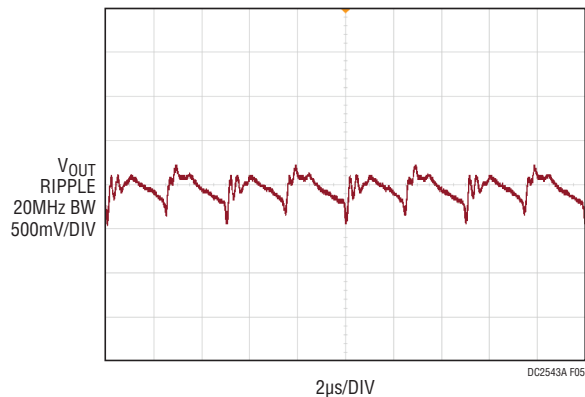

Figure 5. Output Voltage Ripple at $V_{IN} = 48V$, $V_{OUT} = 24V$, $I_{OUT} = 10A$, $f_{SW} = 200kHz$

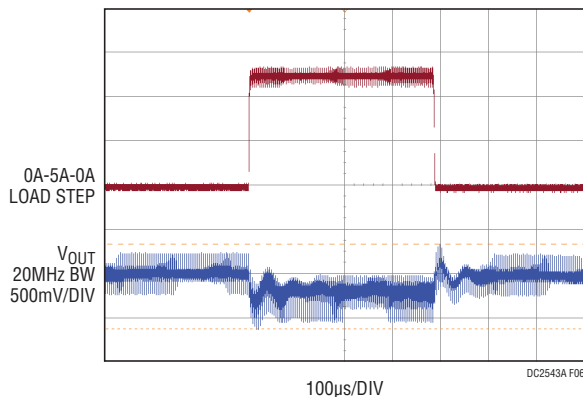

Figure 6. Load Step at $V_{IN} = 48V$, $V_{OUT} = 24V$

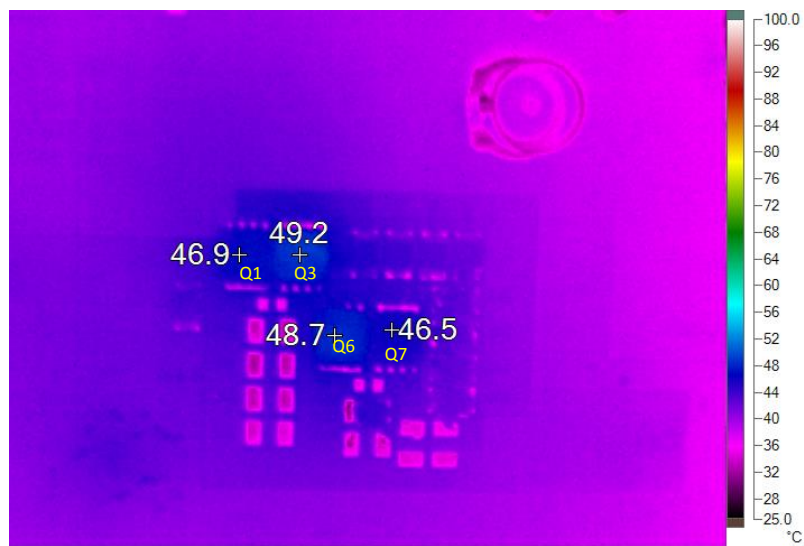

Figure 7. Thermal performance $V_{IN} = 48V$, $V_{OUT} = 24V$, $I_{OUT} = 10A$, $T_A = 23^{\circ}C$, No Airflow

QUICK START PROCEDURE

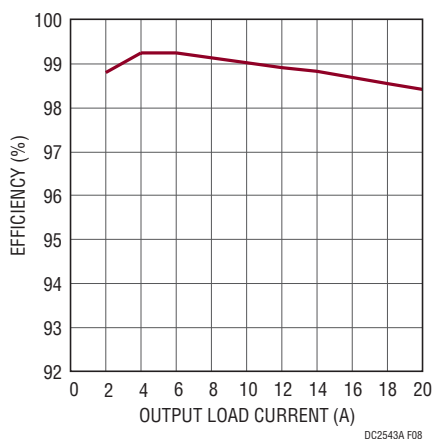

Figure 8. Efficiency vs Load Current at $V_{IN} = 48V$, $V_{OUT} = 24V$, $f_{SW} = 200kHz$ *

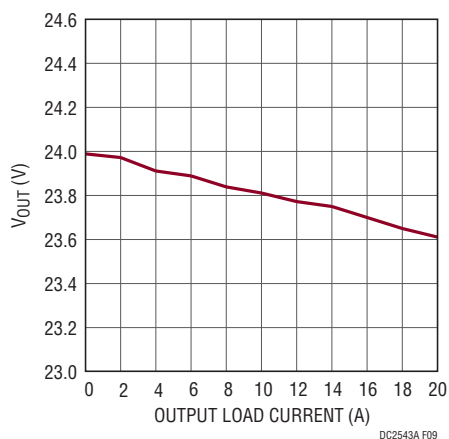

Figure 9. Load Regulation for 20A Design at $V_{IN} = 48V$, $V_{OUT} = 24V$, $f_{SW} = 200kHz$ *

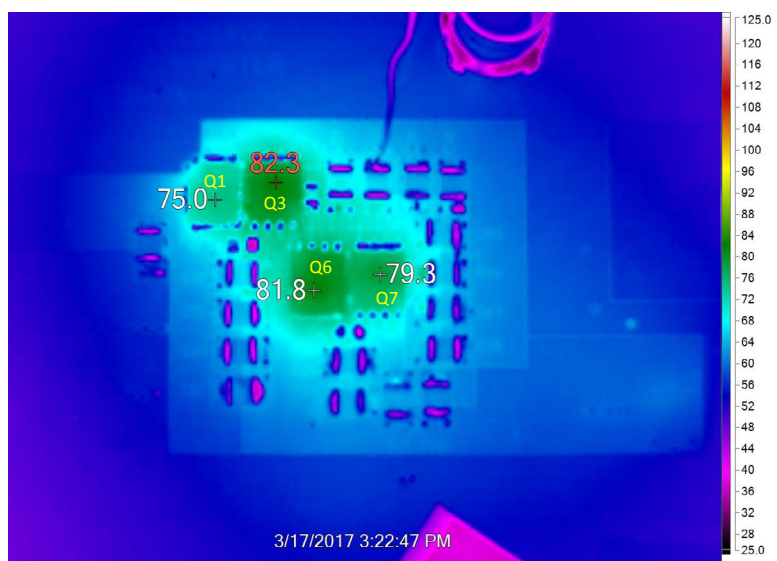

Figure 10. Thermal performance at $V_{IN} = 48V$, $V_{OUT} = 24V$, $I_{OUT} = 20A$, $T_A = 23^\circ C$, No Airflow *

* **Note:** Additional C11, C12, C60, C61, C22-C25, C69-C72, C30, C31, and C36 (10 μ F/50V, MURATA GRM32ER71H106KA12L) are populated; RS1 is changed to 2.5m Ω (WSL20102L500FEB18) for this test.

DEMO MANUAL DC2543A

PARTS LIST

ITEM	QTY	REFERENCE	PART DESCRIPTION	MANUFACTURER/PART NUMBER
Required Circuit Components				
1	1	C1	CAP, 33 μ F 20% 80V ELEC	PANASONIC EEHA1K330P
2	8	C2, C3, C47, C49, C56, C57, C58, C59	CAP, 1210 2.2 μ F 10% 100V X7R	MURATA GRM32DR72A225KA12
3	4	C4, C5, C15, C126	CAP, 0603 0.1 μ F 10% 100V X7R	MURATA GRM188R72A104KA35D
4	2	C6, C7	CAP, 0805 4.7 μ F 10% 16V X7R	MURATA GRM21BR71C475KA73K
5	1	C8	CAP, 0603 0.22 μ F 10% 25V X7R	MURATA GRM188R71E224KA88D
6	2	C9, C26	CAP, 0603 0.47 μ F 10% 25V X7R	MURATA GRM188R71E474KA12D
7	2	C17, C28	CAP, 0805 2.2 μ F 10% 50V X7R	TDK C2012X7R1H225K125AC
8	11	C18, C19, C20, C21, C29, C66, C67	CAP, 1210 10 μ F 10% 50V X7R	MURATA GRM32ER71H106KA12L
9		C68, C73, C74, C65		
10	2	C27, C50	CAP, 0603 1 μ F 10% 50V X5R	MURATA GRM188R61H105K
11	2	C52, C53	CAP, 1210 22 μ F 10% 25V X5R	AVX 12103D226KAT2A
12	1	C54	CAP, 0603 47nF 10% 25V X7R	AVX 06033C473KAT2A
13	1	C55	CAP, 0603 470pF 10% 50V X7R	MURATA GRM188R71H471KA01D
14	3	D1, D2, D3	DIODE, SCHOTTKY	CENTRAL SEMI. CMDSH-4E TR
15	2	D9, D10	DIODE, ZENER	CENTRAL SEMI. CMHZ5236B TR
16	1	L2	IND, 68 μ H	COLLCRAFT, LPS6225-683MRB
17	1	Q1	XSTR, N-CHANNEL MOSFET	INFINEON BSC027N06LS5
18	3	Q3, Q6, Q7	XSTR, N-CHANNEL MOSFET	INFINEON BSC032N04LS
19	4	Q9, Q10, Q11, Q23	XSTR, N-CH 40V 14A TO-252	VISHAY SUD50N04-8M8P-4GE3
20	1	Q22	TRANSISTOR., SOT-23	FAIRCHILD., BSS123L
21	1	RS1	RES., CHIP, 0.005, 1%, 2010	VISHAY, WSL20105L000FEA
22	1	RS2	RES, 2010 0 Ω JUMPER	VISHAY WSL201000000ZEA9
23	2	R1, R7	RES, 0603 1k Ω 1%	VISHAY CRCW06031K00FKEA
24	1	R2	RES, 0603 2.2 Ω 5%	YAGEO RC0603JR-072R2L
25	4	R5, R10, R24, R32	RES, 0603 0 Ω JUMPER	VISHAY CRCW060300000Z0EA
26	4	R9, R13, R17, R28	RES, 0603 10k Ω 1%	NIC NRC06F1002TRF
27	1	R16	RES, 0603 68k Ω 1%	VISHAY CRCW060368K0FKEA
28	1	R18	RES, 0603 100k Ω 1%	VISHAY CRCW0603100K0FKEA
29	1	R26	RES, 0603 154k Ω 1%	YAGEO RC0603FR-07154KL
30	1	R27	RES, 0603 20k Ω 5%	VISHAY CRCW060320K0JNEA
31	1	R29	RES, 0603 80.6k Ω 1%	YAGEO RC0603FR-0780K6L
32	1	R30	RES. 2010 1 Ω 1% 1W	IRC LRC-LR2010-01-1R00-F
33	1	R31	RES, 0603 100 Ω 5%	VISHAY CRCW0603100R0JNEA
34	1	U1	IC, LTC7820EUF, QFN 4mm \times 5mm	LINEAR TECH. ALTC7820EUF#PBF
35	1	U2	IC, LTC3630AEMSE	LINEAR TECH. LTC3630EMSE#PBF

PARTS LIST

Additional Demo Board Circuit Components

1	0	C10-C14, C16, C33, C34, C35, C36, C60-C64, C51, C77	CAPACITOR, OPT	
2	0	C30-C32, C22-C25, C69-C72, C127		
3	0	Q2, Q4, Q5, Q8 OPT	MOSFET, OPT	
4	0	R6, R19, R2, R36, R8, R11, R12, R20, R34, R35, R60	RESISTOR, OPT	

Hardware: For Demo Board Only

1	9	E1, E2, E6-E8, E10, E12, E14, E15	TURRET	MILL-MAX 2501-2-00-80-00-00-07-0
2	1	JP2	HEADER, 3 PIN 2mm	WURTH ELEKTRONIK 62000311121
3	4	J1, J2, J3, J4	JACK, BANANA	KEYSTONE, 575-4
4	2	J5, J6	CONN, BNC, 5 PINS	CONNEX, 112404
5	1	SW1	SWITCH, SUBMINATURE SLIDE	C&K COMPONENTS, JS202011CQN
6	1	XJP2	SHUNT 2mm	WURTH ELEKTRONIK 60800213421
7	4	STANDOFF	STANDOFF, SNAP ON	KEYSTONE 8833

DEMO MANUAL DC2543A

SCHEMATIC DIAGRAM

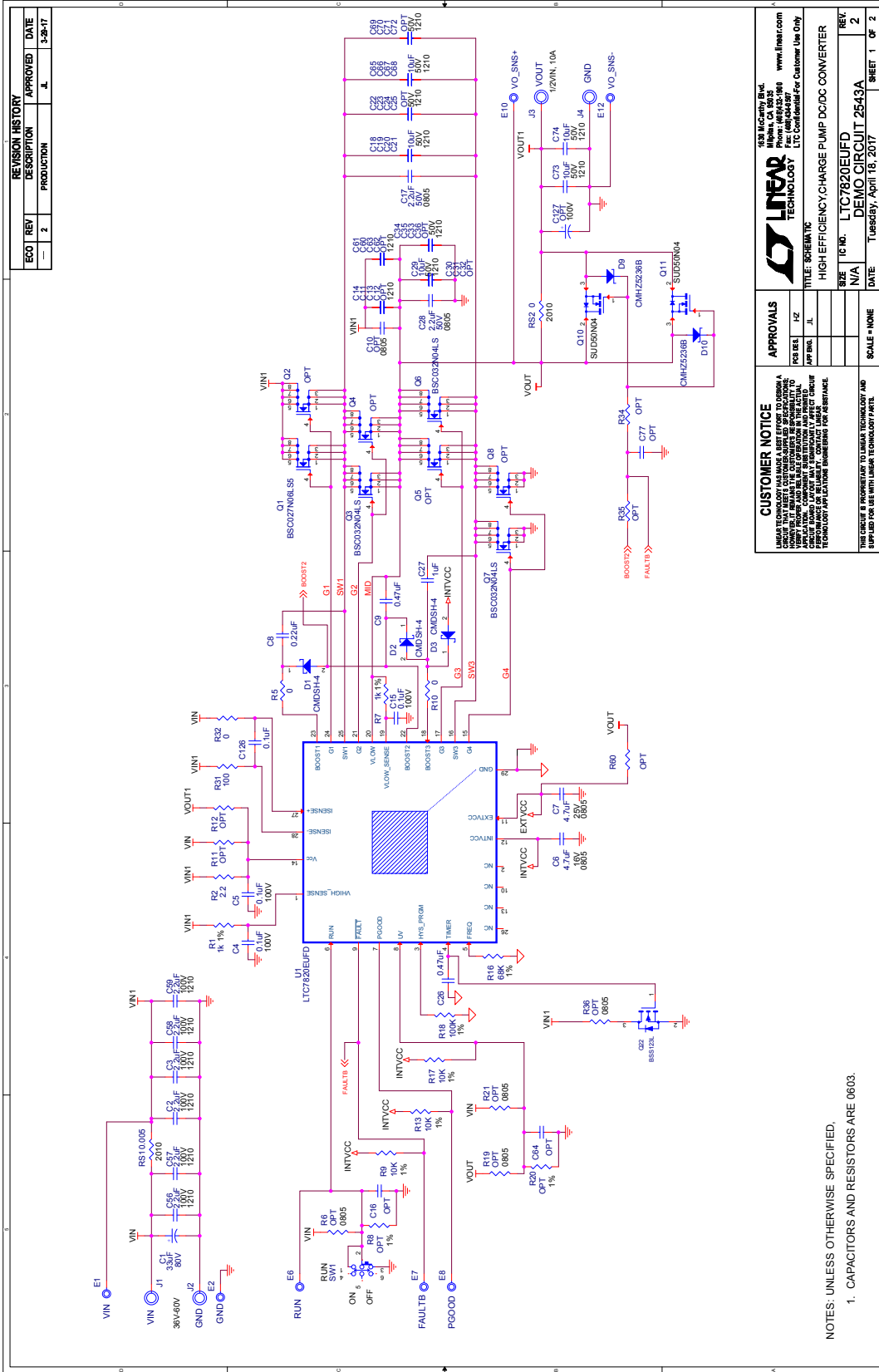

REVISION HISTORY

ECO	REV	DESCRIPTION	DATE
-	2	PRODUCTION	1-24-17

APPROVALS

DESIGNER	DATE	SCALE	NOTES
JL		N/A	

CUSTOMER NOTICE

THIS CIRCUIT IS PROPRIETARY TO LINEAR TECHNOLOGY AND IS SUPPLIED FOR USE WITH LINEAR TECHNOLOGY PARTS.

LINEAR TECHNOLOGY IS NOT RESPONSIBLE FOR REPRODUCTION OF THIS CIRCUIT FOR ANY OTHER APPLICATIONS. REPRODUCTION OF THIS CIRCUIT FOR ANY OTHER APPLICATIONS WITHOUT THE WRITTEN PERMISSION OF LINEAR TECHNOLOGY IS STRICTLY PROHIBITED. LINEAR TECHNOLOGY ACCEPTS NO LIABILITY FOR ANY DAMAGES, INCLUDING CONSEQUENTIAL DAMAGES, ARISING FROM THE USE OF THIS CIRCUIT. REPRODUCTION OF THIS CIRCUIT FOR ANY OTHER APPLICATIONS WITHOUT THE WRITTEN PERMISSION OF LINEAR TECHNOLOGY IS STRICTLY PROHIBITED.

LINEAR TECHNOLOGY
1324 McCarty Blvd.
Folsom, CA 95630
www.linear.com
Tel: (916) 961-8000
Fax: (916) 961-3047
LTC Confidential For Customer Use Only

TITLE: SCHEMATIC
HIGH EFFICIENCY CHARGE PUMP DC/DC CONVERTER
SIZE: 16 IN.
PART NO.: LTC7828EUF
DEMO CIRCUIT 2543A
REV: 2
DATE: Tuesday, April 18, 2017
SHEET 1 OF 2

NOTES: UNLESS OTHERWISE SPECIFIED,
1. CAPACITORS AND RESISTORS ARE 0603.

DEMO MANUAL DC2543A

DEMONSTRATION BOARD IMPORTANT NOTICE

Linear Technology Corporation (LTC) provides the enclosed product(s) under the following **AS IS** conditions:

This demonstration board (DEMO BOARD) kit being sold or provided by Linear Technology is intended for use for **ENGINEERING DEVELOPMENT OR EVALUATION PURPOSES ONLY** and is not provided by LTC for commercial use. As such, the DEMO BOARD herein may not be complete in terms of required design-, marketing-, and/or manufacturing-related protective considerations, including but not limited to product safety measures typically found in finished commercial goods. As a prototype, this product does not fall within the scope of the European Union directive on electromagnetic compatibility and therefore may or may not meet the technical requirements of the directive, or other regulations.

If this evaluation kit does not meet the specifications recited in the DEMO BOARD manual the kit may be returned within 30 days from the date of delivery for a full refund. **THE FOREGOING WARRANTY IS THE EXCLUSIVE WARRANTY MADE BY THE SELLER TO BUYER AND IS IN LIEU OF ALL OTHER WARRANTIES, EXPRESSED, IMPLIED, OR STATUTORY, INCLUDING ANY WARRANTY OF MERCHANTABILITY OR FITNESS FOR ANY PARTICULAR PURPOSE. EXCEPT TO THE EXTENT OF THIS INDEMNITY, NEITHER PARTY SHALL BE LIABLE TO THE OTHER FOR ANY INDIRECT, SPECIAL, INCIDENTAL, OR CONSEQUENTIAL DAMAGES.**

The user assumes all responsibility and liability for proper and safe handling of the goods. Further, the user releases LTC from all claims arising from the handling or use of the goods. Due to the open construction of the product, it is the user's responsibility to take any and all appropriate precautions with regard to electrostatic discharge. Also be aware that the products herein may not be regulatory compliant or agency certified (FCC, UL, CE, etc.).

No License is granted under any patent right or other intellectual property whatsoever. **LTC assumes no liability for applications assistance, customer product design, software performance, or infringement of patents or any other intellectual property rights of any kind.**

LTC currently services a variety of customers for products around the world, and therefore this transaction **is not exclusive**.

Please read the DEMO BOARD manual prior to handling the product. Persons handling this product must have electronics training and observe good laboratory practice standards. **Common sense is encouraged.**

This notice contains important safety information about temperatures and voltages. For further safety concerns, please contact a LTC application engineer.

Mailing Address:

Linear Technology
1630 McCarthy Blvd.
Milpitas, CA 95035

Copyright © 2004, Linear Technology Corporation