



# LV8762T

Bi-CMOS LSI

## Forward/Reverse H-bridge Driver Application Note

ON Semiconductor®

<http://onsemi.com>

### Overview

The LV8762T is a 1-channel H-bridge motor driver that can control four operation modes (forward, reverse, brake, and standby) of a motor. The IC is optimal for use in driving brushed DC motors for office equipment.

### Function

- Forward/reverse H-bridge motor driver: 1 channel
- Built-in current limiter
- Built-in thermal protection circuit
- Single power supply
- Built-in short-circuit protection function (selectable from latch-type or auto reset-type).
- $I_{Omax} = 1A$
- Current limit mask function
- Alert signal output

### Typical Applications

- Multi Function Printer
- Plain Paper Copier
- Laser Beam Printer
- Photo Printer
- Page Scanner
- Industrial
- Cash Dispenser
- Entertainment

### Pin Assignment

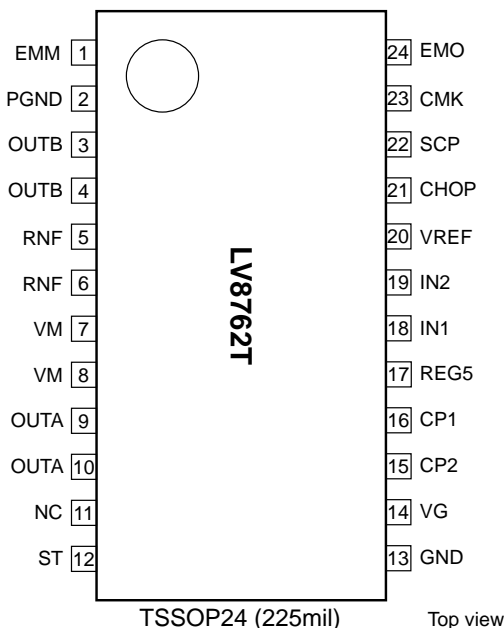

### Package Dimensions

unit: mm(typ)

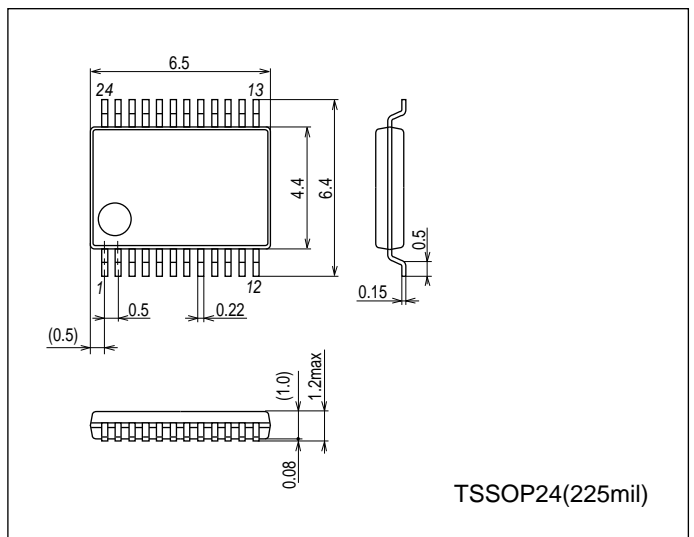

## Recommended Soldering Footprint

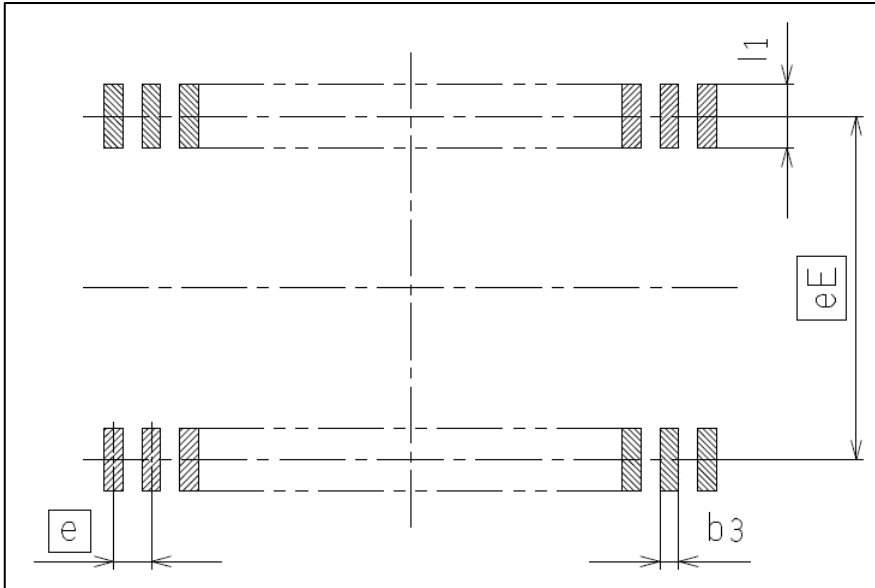

Reference Symbol	TSSOP24(225mil)
eE	5.80
e	0.50
b3	0.32
l1	1.00

## Specifications

### Absolute Maximum Ratings at Ta = 25°C

Parameter	Symbol	Conditions	Ratings	Unit
Supply voltage	VM max		36	V
Output peak current	IO peak	tw ≤ 10ms, duty 20%	1.5	A
Output continuous current	IO max		1.0	A
Logic input voltage	VIN max		-0.3 to +6	V
EMO pin input voltage	VEMO		-0.3 to +6	V
Allowable power dissipation	Pd max	Mounted on a specified board. *	1.4	W
Operating temperature	Topr		-20 to +85	°C
Storage temperature	Tstg		-55 to +150	°C

\* Specified circuit board : 57mm×57mm×1.6mm, glass epoxy both-type board.

Caution 1) Absolute maximum ratings represent the value which cannot be exceeded for any length of time.

Caution 2) Even when the device is used within the range of absolute maximum ratings, as a result of continuous usage under high temperature, high current, high voltage, or drastic temperature change, the reliability of the IC may be degraded. Please contact us for the further details.

Stresses exceeding Maximum Ratings may damage the device. Maximum Ratings are stress ratings only. Functional operation above the Recommended Operating Conditions is not implied. Extended exposure to stresses above the Recommended Operating Conditions may affect device reliability.

# LV8762T Application Note

## Recommended Operating Conditions at Ta = 25°C

Parameter	Symbol	Conditions	Ratings			Unit
			min	typ	max	
Supply voltage range	VM		9		32	V
VREF input voltage	VREF		0		3	V
Logic input voltage	V <sub>IN</sub>		0		5.5	V

## Electrical Characteristics at Ta = 25°C, VM = 24V, VREF = 1.5V

Parameter	Symbol	Conditions	Ratings			Unit
			min	typ	max	
<b>General</b>						
Standby mode current drain	IMst	ST = "L"		100	400	μA
Operating mode current drain	IM	ST = "H", IN1 = "H", IN2 = "L", with no load		3	5	mA
REG5 output voltage	VREG	I <sub>O</sub> = -1mA	4.5	5	5.5	V
Thermal shutdown temperature	TSD	Design guarantee *	150	180	200	°C
Thermal hysteresis width	ΔTSD	Design guarantee *		40		°C
<b>Output block</b>						
Output on resistance	RonU	I <sub>O</sub> = 1A, upper side ON resistance		0.75	0.97	Ω
	RonD	I <sub>O</sub> = -1A, under side ON resistance		0.5	0.65	Ω
Output leakage current	I <sub>Oleak</sub>	V <sub>O</sub> = 32V			50	μA
Diode forward voltage	VD	ID = -1A		1.2	1.4	V
Rising time	tr	10% to 90%		100	200	ns
Falling time	tf	90% to 10%		100	200	ns
Input output delay time	tpLH	IN1 to OUTA, IN2 to OUTB (L → H)		550	750	ns
	tpHL	IN1 to OUTA, IN2 to OUTB (H → L)		550	750	ns
<b>Control system input block</b>						
Logic pin input H-level voltage	V <sub>INH</sub>		2.0			V
Logic pin input L-level voltage	V <sub>INL</sub>				0.8	V
Logic pin input current 1	I <sub>INL</sub>	V <sub>IN</sub> = 0.8V	4	8	12	μA
	I <sub>INH</sub>	V <sub>IN</sub> = 5V	30	50	70	μA
VREF input current	IREF	VREF = 1.5V	-0.5			μA
Current limit comparator threshold voltage	V <sub>tlim</sub>	VREF = 1.5V	0.291	0.3	0.309	V
CHOP pin charge current	I <sub>CHOP</sub>		-6.5	-5	-3.5	μA
CHOP pin threshold voltage	V <sub>tCHOP</sub>		0.8	1	1.2	V
CMK pin charge current	I <sub>CMK</sub>		-32.5	-25	-17.5	μA
CMK pin threshold voltage	V <sub>tCMK</sub>		1.2	1.5	1.8	V
<b>Charge pump block</b>						
Step-up voltage	VGH	VM = 24V	27.7	28.7	29.7	V
Rising time	t <sub>ONG</sub>	VG = 0.1μF		250	550	μs
Oscillation frequency	F <sub>cp</sub>		90	125	155	kHz
<b>Short-circuit protection block</b>						
EMO output saturation voltage	V <sub>EMO</sub>	I <sub>EMO</sub> = 1mA			0.4	V
SCP pin charge current	I <sub>SCP</sub>	SCP = 0V	-6.5	-5	-3.5	μA
Comparator threshold voltage	V <sub>tSCP</sub>		0.8	1	1.2	V

\* Design guarantee value and no measurement were made.

# LV8762T Application Note

## Block Diagram

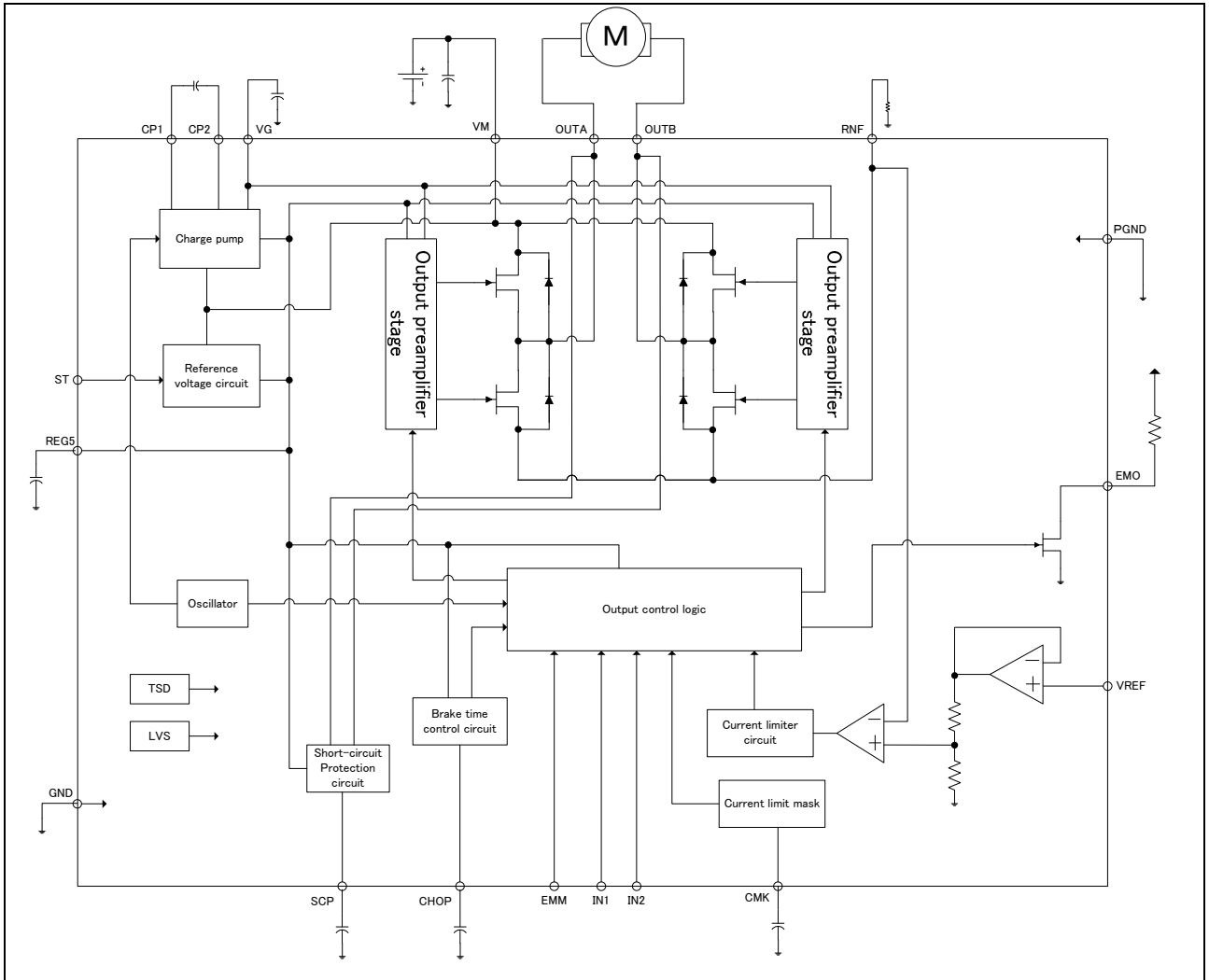

# LV8762T Application Note

VCC=5V, Temp=25 ° C

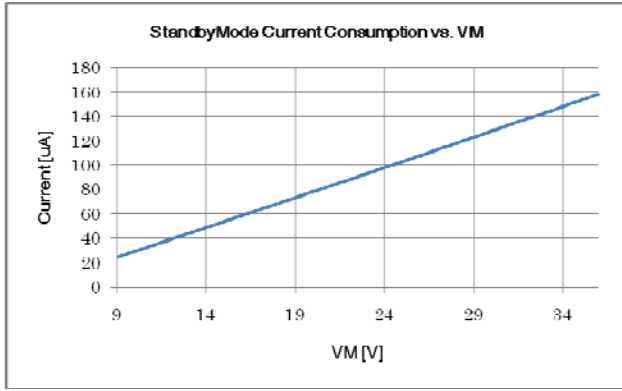

VCC=5V, VM=24V

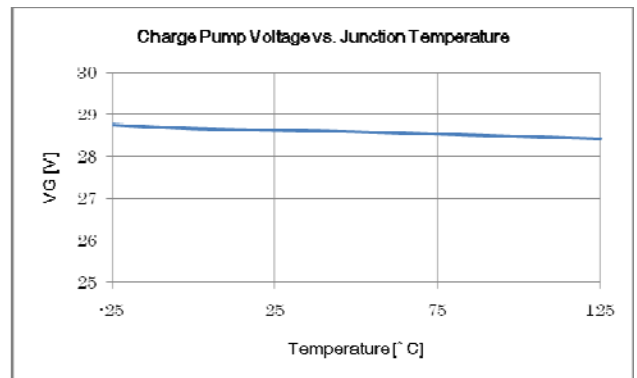
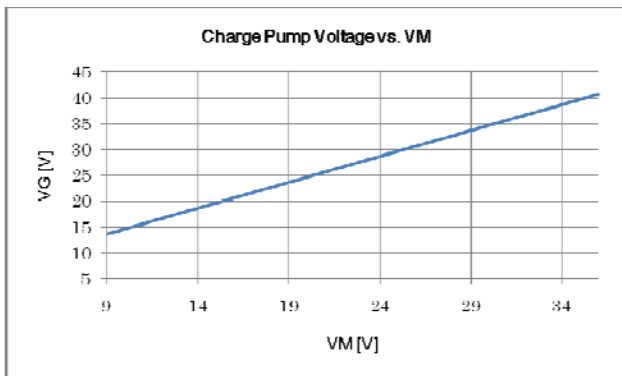
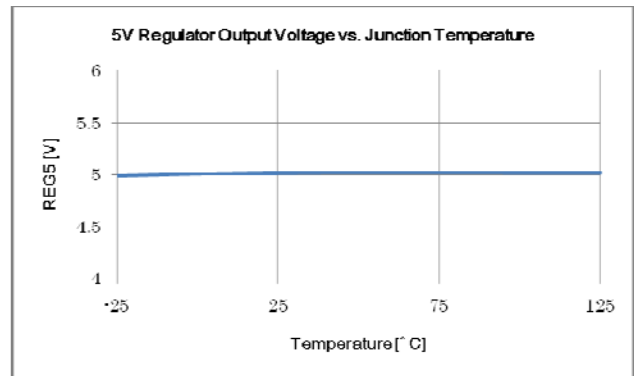
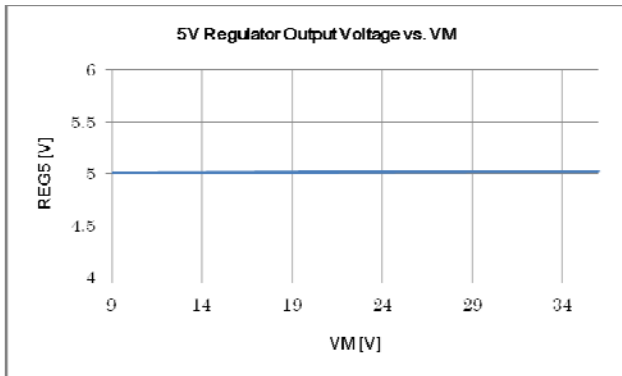
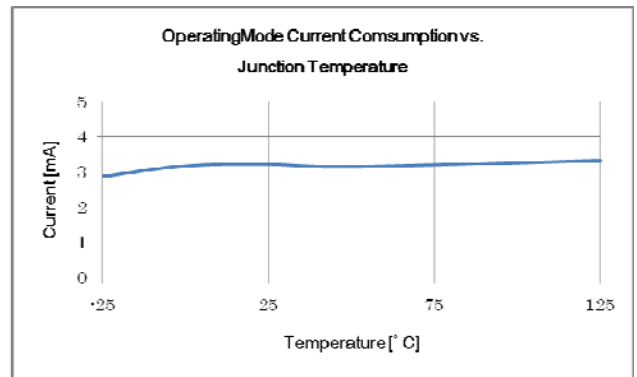
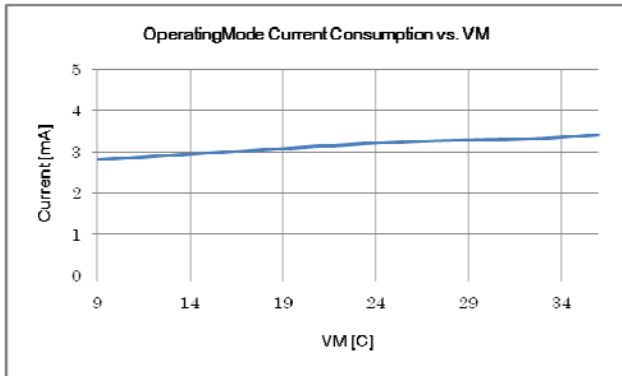
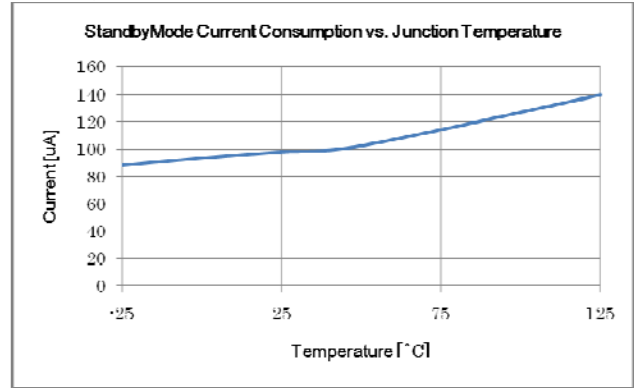

# LV8762T Application Note

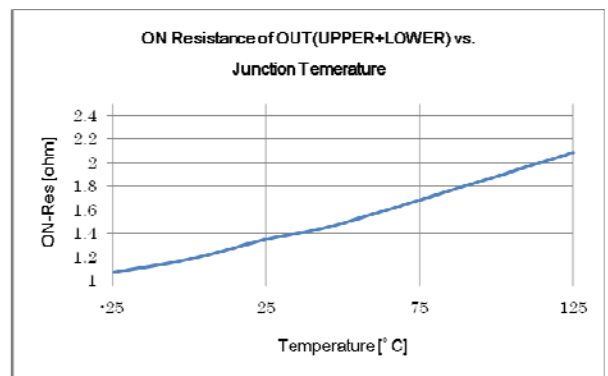
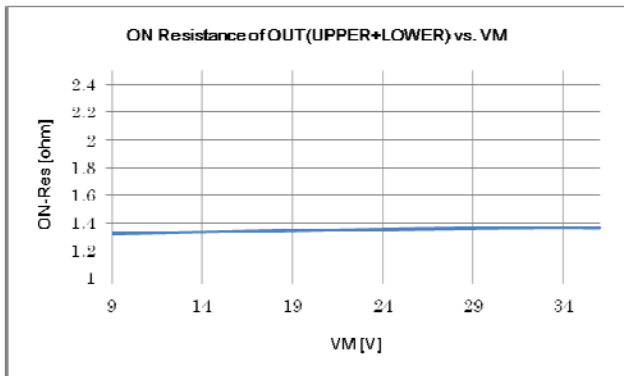
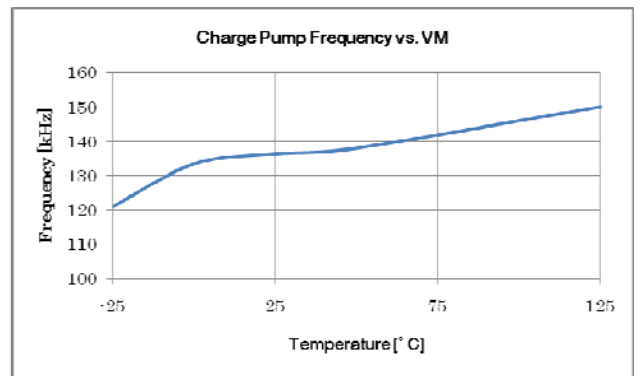
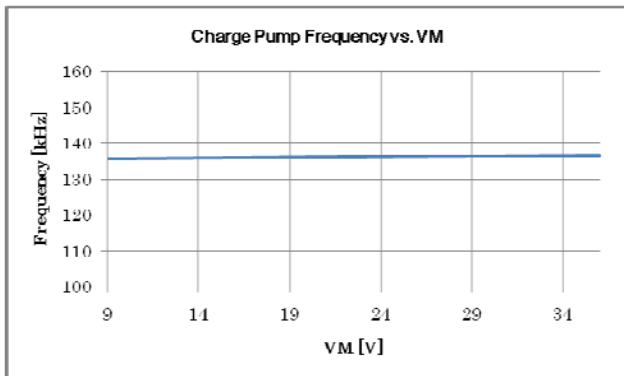
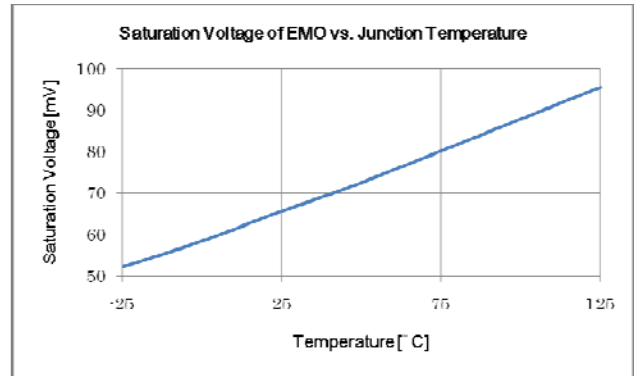
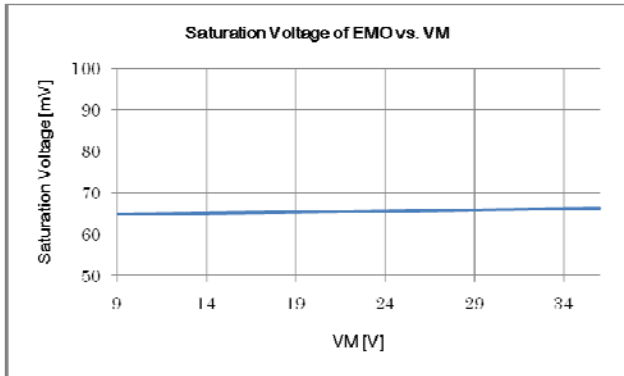
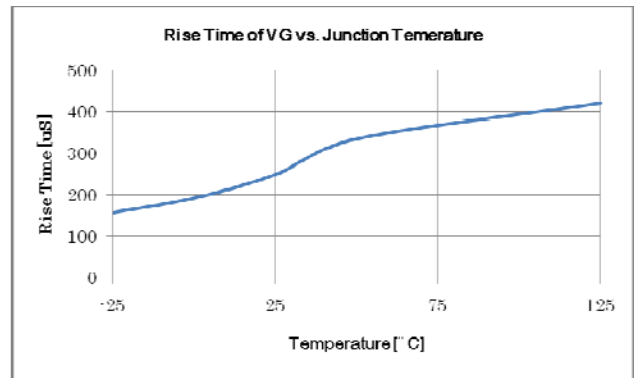
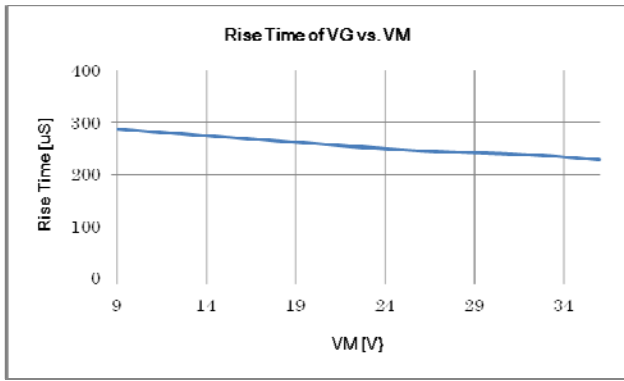

# LV8762T Application Note

## Pd-Ta Chart

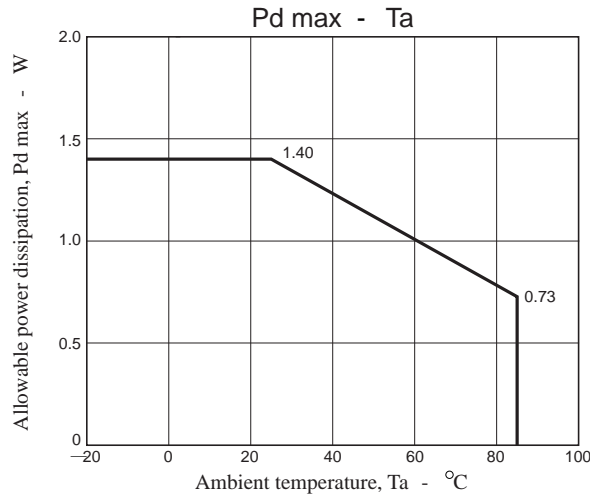

## PCB Specifications

(PCB recommended for operation of LV8762T)

Size: 57mm × 57mm × 1.6mm (two-layer substrate)

Material: Glass epoxy-type board

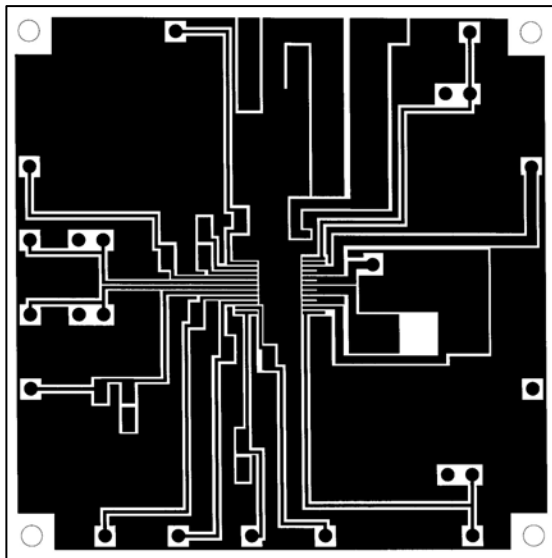

L1 : Copper wiring pattern diagram

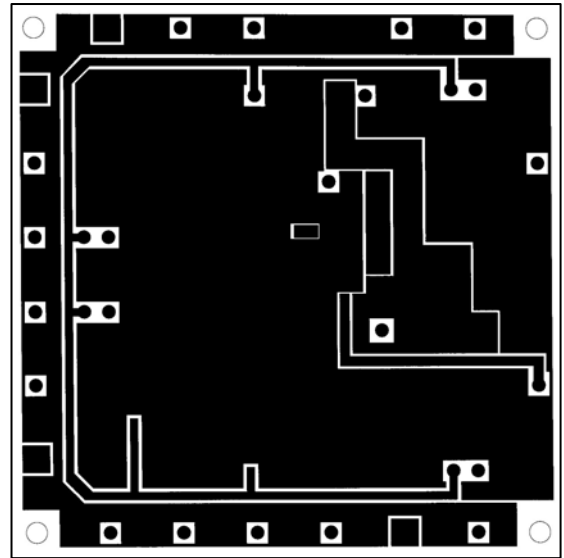

L2 : Copper wiring pattern diagram

## Cautions

- 1) For the set design, employ the derating design with sufficient margin.  
Stresses to be derated include the voltage, current, junction temperature, power loss, and mechanical stresses such as vibration, impact, and tension.  
Accordingly, the design must ensure these stresses to be as low or small as possible.  
The guideline for ordinary derating is shown below:
  - (1)Maximum value 80% or less for the voltage rating
  - (2)Maximum value 80% or less for the current rating
  - (3)Maximum value 80% or less for the temperature rating
- 2) After the set design, be sure to verify the design with the actual product.  
Confirm the solder joint state and verify also the reliability of solder joint for the Exposed Die-Pad, etc.  
Any void or deterioration, if observed in the solder joint of these parts, causes deteriorated thermal conduction, possibly resulting in thermal destruction of IC.

# LV8762T Application Note

## Pin Functions

Pin No.	Pin Name	Pin Function	Equivalent Circuit
18 19 1	IN1 IN2 EMM	Output control signal input pin 1. Output control signal input pin 2. Short protection mode setting.	
12	ST	Standby mode setting	
9, 10 3, 4 7, 8 5, 6 2	OUTA OUTB VM RNF PGND	OUTA output pin. OUTB output pin. Motor power-supply connection pin. Current sense resistor connection pin. Power ground.	
14 8 16 15	VG VM CP1 CP2	Charge pump capacitor connection pin. Motor power-supply connection pin. Charge pump capacitor connection pin. Charge pump capacitor connection pin.	

Continued on next page.



# LV8762T Application Note

Continued from preceding page.

Pin No.	Pin Name	Pin Function	Equivalent Circuit
20	VREF	Reference voltage input pin for output current limit setting.	
17	REG5	Internal reference voltage output pin.	
24	EMO	Alert signal output	
21 22	CHOP SCP	Capacitor connection for current limit break time setting Capacitor connection for short detection time setting	
23	CMK	Capacitor connection for current limit mask setting	

# LV8762T Application Note

## Application Information

### Introduction

The LV8762T is a simple 1-channel brushed DC MOTOR driver for printers, cash dispenser, amusement, and so on. This device has 4 mode operations as FORWARD, REVERSE, SHORT-BREAK, and OFF. It has some protection functions and it has 5V-regulator for single power supply operation. So it is easy and safe to use.

- Low standby current consumption: Almost circuit blocks are shutdown during standby-mode as ST pin is LOW.
- Mid-range output current: The LV8762 has H-Bridge with 1A-range. If looking for the other output current range devices, please contact our sales.
- Built-in charge-pump
- Built-in 5V regulator
- Current limiter by current chopping
- Current limiter masking
- Short circuit protector
- Over current protector
- Over heat protector
- ALERT signal.

### Regulator block

The LV8762T has a 5V regulator for Single Power Supply Operation. This regulator has a capability of about 5mA for the internal blocks. For external usages, it can be used for pull-up, and as reference voltage. The load regulation is shown in Figure. 1. This regulator is disabled by the ST pin when set to LOW or OPEN.

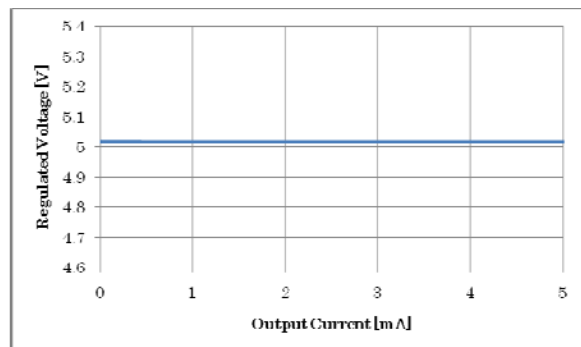

Figure. 1 VM=24V C<sub>REG5</sub>=0.1uF

### Charge-pump block

The LV8762T has a charge-pump. It generates voltage about VM+4V to the VG pin for drive gate of H-bridge. This charge pump block needs two capacitors between CP1 to CP2, and VG to GND. In the standby mode, charge pump block is disabled for low power consumption as ST pin is LOW. This is up converted voltage as VG pin for use only internal blocks. It should not use the VG power for other purposes. The load regulation chart is shown in Figure. 2 **VM=24V CP1-CP2=0.1uF CVG=0.1uF.**

The charge pump is started by setting ST pin to HIGH. It needs about 250us to work the H-bridge. So it should wait more than 250us once ST pin is set to HIGH for correct operation. The figure of

transition VG pin during start up is shown in Figure. 3.

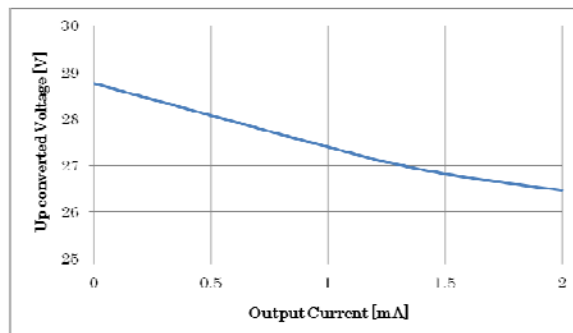

Figure. 2 VM=24V CP1-CP2=0.1uF C<sub>VG</sub>=0.1uF

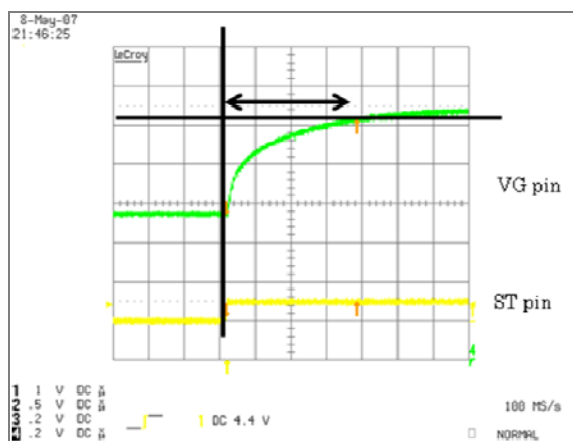

Figure. 3 VM=24V C<sub>VG</sub>=0.1uF Thresh=VM+4V

### Output H-Bridge block

This LSI is a 1- channel H-Bridge driver. The upper side ON resistance is 0.75 ohm and the lower side ON resistance is 0.5 ohm TYP; it can use 1A continuously, and the peak current is 1.5A. This LSI gets heat by the current as  $W = I_{out}^2 \times (R_{ON-upper} + R_{ON-under})$ . When designing a PCB, the LV8762T have to use under PdMAX value on Absolute Maximum Ratings. If power is over the PdMAX, it will be destroyed by overheating so it is necessary to have heat sink or larger PCB pattern. The Pdmax-Ta chart is shown above.

The line to VM, OUTA, OUTB, and RNF throw high current so this line needs thicker one. The reference PCB pattern is shown above.

### Current sensing block

The RNF resistor serves as the current sensor. There is a voltage produced by the current flowing from the output of the motor driver circuit to GND through the RNF resistor. This voltage is compared with the VREF. The RNF resistor is decided by the current limit value, see the topic of 'Current Limit block'.

### Current Limiter block

The LV8762T has a current limit function. Output current starts to chop when the current is over the value of VREF over RNF (see Figure. 4.) The value of current limit is decided by the equation below. When the output current exceeds that value, the output transistor becomes OFF. And next, that is

# LV8762T Application Note

become ON by CHOP timer like PWM. The current limiter utilizes PWM control in order to acquire very efficient current limiter.

$$\text{Limit[A]} = \text{VREF[V]} / 5 / \text{RNF[ohm]}$$

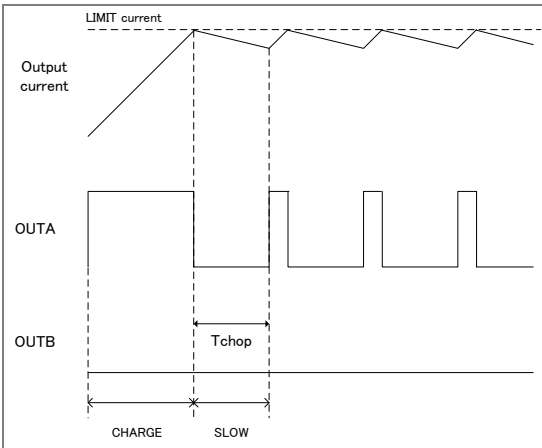

Figure. 4 Waveform of CHOP sequence

### Current Limit Mask block

The current becomes high when round up the dc-motor because the motor generates no EMF. So when rounding up the motor, it needs current as shown in the equation below. The EMF stands for Electromotive Force. The EMF is generated by rotating the motor. The EMF is proportional to the rounding speed of the motor.

$$I[A] = \text{VM[V]} / (\text{Motor Resistance} + \text{R}_{\text{ON}} + \text{RNF[ohm]})$$

The current limiter has many functions too. It causes a slow start up to the motor. If it should round up the motor too fast, it should use the Current Limit Mask function. The current limit is stopped by Current Limit Mask during masking time that is set by CMK capacitor. The masking time is calculated by the equation below.

$$T_{\text{CMK[sec]}} = C_{\text{CMK[uF]}} \times 1.5[\text{V}] / 25[\text{uA}]$$

This situation is shown in Figure. 5.

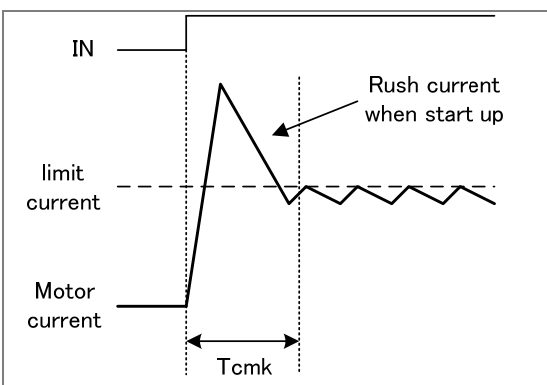

Figure. 5 Waveform of CMK sequence

The current is less than round up current at almost case during rounding the motor because the BEMF is generated by the rounding motor.

$$I[A] = (\text{VM[V]} - \text{BEMF[V]}) / (\text{Res as above [ohm]})$$

If this function is not used, CMK pin is set OPEN or pull-up to the REG5 pin.

### VREF input block

The VREF pin is used for setting the motor current limit value. The voltage range is limited from 0V to around 3V by internal circuit. When voltage is over 3V, the current limit circuit will not function. Pull-up the VREF pin to REG5 pin when not using the current limit.

### Short Circuit Protection block

The short circuit detector watches the OUTA and OUTB. It can detect the short line that are between OUTA to OUTB, OUTA to VM, OUTA to GND, OUTB to VM, OUTB to GND. The Short Circuit Protection circuit disabled the Output circuit when it senses 2A; it ignores when shorted time is under 2useconds. The short circuit detector checks the current two times to prevent the false detection.

The first check is started immediately. A timing of second time check is decided by the SCP capacitor. These timing charts are shown in Figure. 6

Waveform of SCP (Latch Mode). The first period in figure shows the case of no short circuit occurrence because the time of short circuit is under 2uS. The second period shows the short circuit protection sequence. After a moment that is decided by the SCP capacitor, the output is switched ON, and current is checked again. If the circuit is still shorted, the output is switched OFF again. The detection time is calculated by the equation below.

$$T_{\text{SCP[sec]}} = C_{\text{SCP[uF]}} \times 1.0[\text{V}] / 5[\text{uA}]$$

The short circuit detector has twice sequence. One is the Latch Mode and the other is the Auto Retry Mode. Both modes are decided by the state of EMM pin. The truth table is shown in Table 1. The Latch Mode is to OFF the output permanently until there are changes in the ST pin. The Auto Retry Mode is to OFF the output and check continuously for flowing current. The checking interval is about 2ms. The checking process is same as the Latch Mode. The Auto Retry Mode sequence is shown in Figure. 7

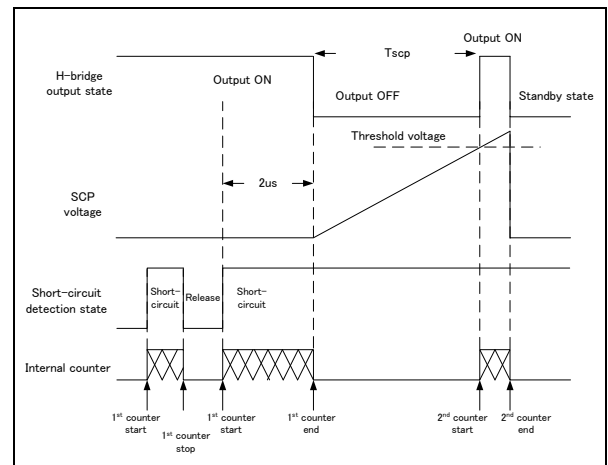

Figure. 6 Waveform of SCP (Latch Mode)

## LV8762T Application Note

EMM	Short Circuit Mode
L Open	Latch Mode
H	AutoRetry Mode

**Table 1 Truth Table of EMM**

### Alert signal block

The EMO pin outputs the ALERT signal. The alert signal is asserted when shorted outputs and overheating are detected. This pin is Open-drain type, so it should be pulled up when using this pin. Let this pin open if not in use. The EMO pin has  $R_{ON}$  that is 400[ohm]@1mA. Decide the resistance of pull-up res below threshold value of MCU.

### Control Input block

The LV8762T has three pins for operation: ST pin, IN1 pin and IN2 pin. The ST pin switches standby-mode and operating-mode. IN1 and IN2 pins are responsible for the direction of the motor. The truth table is shown in Table 2.

The LV8762T will be in standby mode when ST pin is set to LOW, despite the state of IN1 pin and IN2 pin. In this condition OUTA and OUTB become OFF state. Set ST pin to HIGH to operate the OUT pin.

The BREAK state means short break. It makes the OUTA and OUTB to be shorted to the RNF pin. It is possible to stop the motor early because the current that generated EMF is used to stop the motor.

There are no limitations to change the state to another state. However, it is necessary to take care of rush current of the motor over the current of maximum rating when changing the state- both stopping to moving, and rounding forward to reverse. Rush current becomes too high when rounding changes forward to reverse and the opposite because the high current is generated by EMF and VM. The equation is shown below.

$$I_{RUSH-MAX}[A] = (VM[V]+EMF[V]) / Ra[ohm]$$

Ra = Resistance of the winding of the motor.

ST	Input		Output	
	IN1	IN2	OUTA	OUTB
L open	-	-	OFF	OFF
H	L	L	OFF	OFF
H	H	L	ON	OFF
H	L	H	OFF	ON
H	H	H	BREAK	BREAK

**Table 2 Truth Table of Control**

### Thermal shutdown block

The LV8762 has over heat protector. When junction temperature is higher than about 180°C the output is turned OFF by this block. The output is set to OFF continuously during the junction temperature is higher about 180°C. When the junction temperature is less than about 180-40°C, the output restarts and will work normally. When this block detects overheating, it asserts signal to the EMO pin. This signal assertion continues until ST pin sets to negative.

# LV8762T Application Note

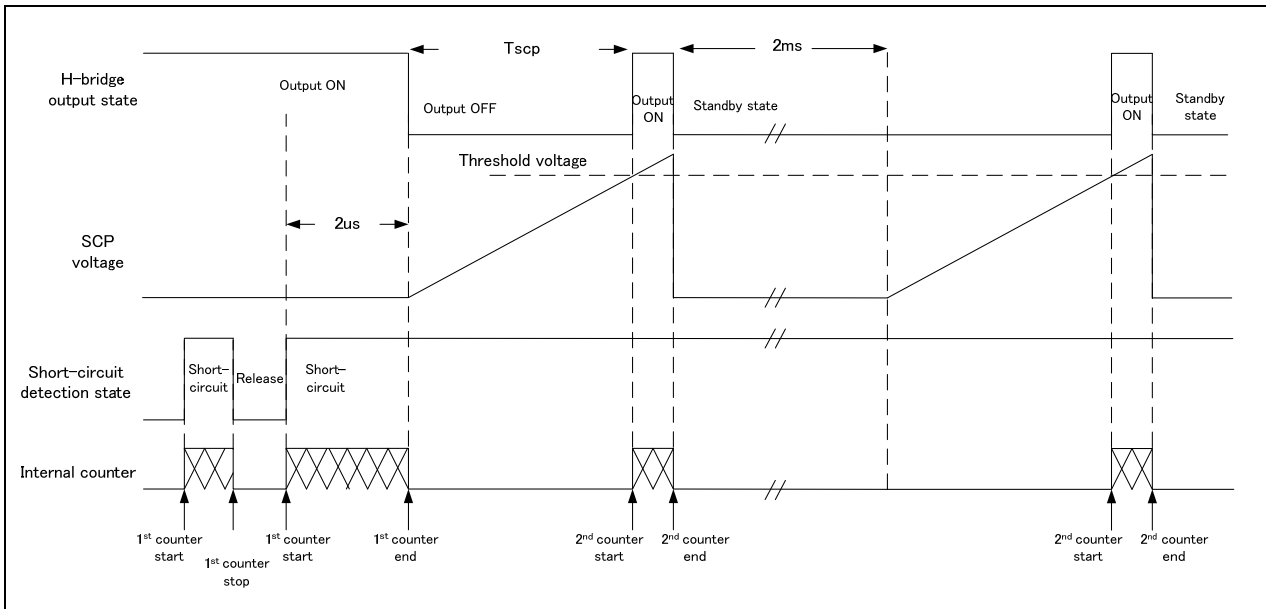

Figure 7 Waveform of SCP sequence (Auto Retry Mode)

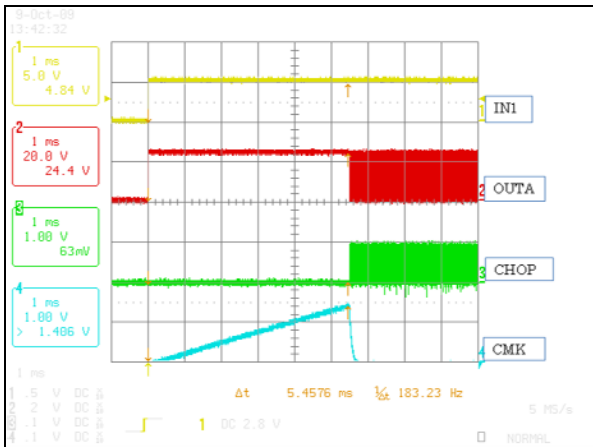

Figure 8 Waveform of CMK sequence

Figure 8 Waveform of CMK sequence shows the sequence when the motor is turned on. When the IN get changing state, the CMK pin start charging to the CMK capacitor. In this period, the current limiter does not work. When the CMK voltage is higher than CMK threshold value, the current limiter starts.

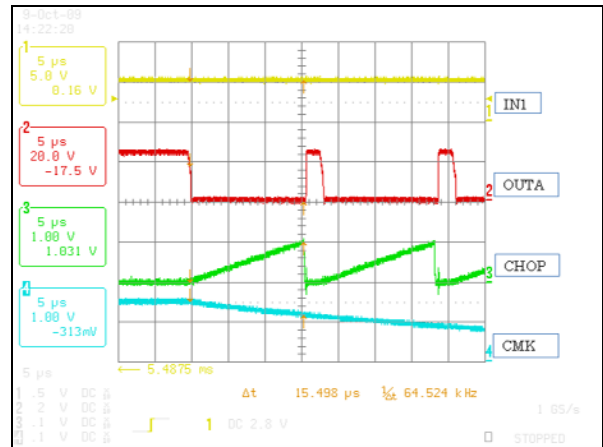

Figure 9 Waveform of CHOP sequence

Figure 9 shows the sequence of current limiter. When the CMK voltage is over the CMK threshold voltage, the current limiter starts. The output becomes temporary off when the current is higher than threshold that is decided by VREF pin. And the CHOP capacitor is charged. When CHOP capacitor over the thresh voltage, the OUTPUT become ON again. And repeat the detection of current.

# LV8762T Application Note

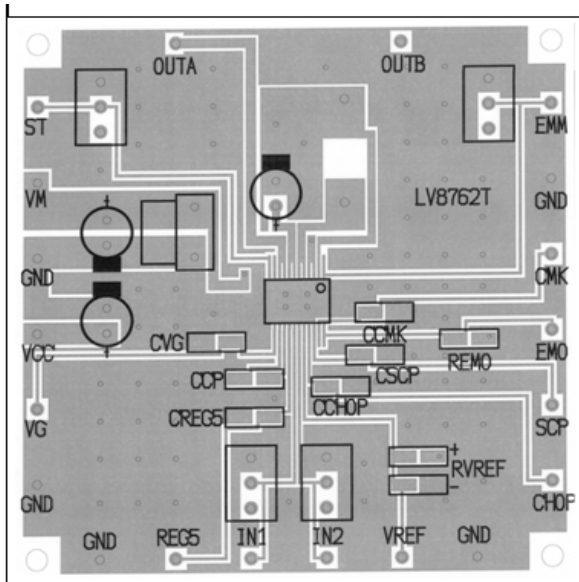

Figure. 10 PCB Design of Component side

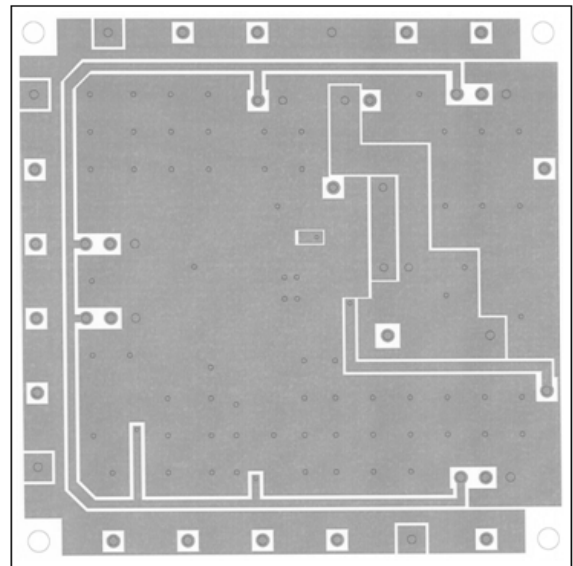

Figure. 11 PCB Design of Solder side.

## BILL OF materials FOR THE EVALUATION BOARD (LV8762TEVB)

Design ator	Qty	Descripti on	Value	Tol	Foot- print	Manufacture	Manufacture partnumber	Substitution Allowed	Pb-Free
CVM	1	VM cap	10uF/50V	±20%	1608	SUN Electronic Industries	50ME10HC	yes	yes
CVG	1	VG cap	0.1uF/100V	±10%	1608	MURATA	GRM188R72A104KA35D	yes	yes
CCP	1	CP cap	0.1uF/100V	±10%	1608	MURATA	GRM188R72A104KA35D	yes	yes
CREG5	1	5Vreg cap	0.1uF/100V	±10%	1608	MURATA	GRM188R72A104KA35D	yes	yes
CCHOP	1	CHOP cap	47pF/50V	±5%	1608	MURATA	GRM1882C1H470J	yes	yes
CSCP	1	SCP cap	47pF/50V	±5%	1608	MURATA	GRM1882C1H470J	yes	yes
CCMK	1	CMK cap	0.1uF/100V	±10%	1608	MURATA	GRM188R72A104KA35D	yes	yes
REMO	1	EMO pull-up res	47k ohm	±5%	1608	KOA	RK73B1JT473J	yes	yes
RNF	1	Current Sense res	0.47 ohm	±5%	6432	ROHM	MCR100JZHJLR47	yes	yes
ST, IN1, IN2, EMM	4	SWITCH				MIYATA ELECTRIC	MS-621C-A01	yes	yes
ST, VM, VG, VCC, GND, REG5, IN1, IN2, VREF, CHOP, SCP, EMO, CMK, EMM, OUTA, OUTB	16	TEST PIN				MAC8	ST-1-3	yes	yse
LV8762 T-EVB Board	1								no

# LV8762T Application Note

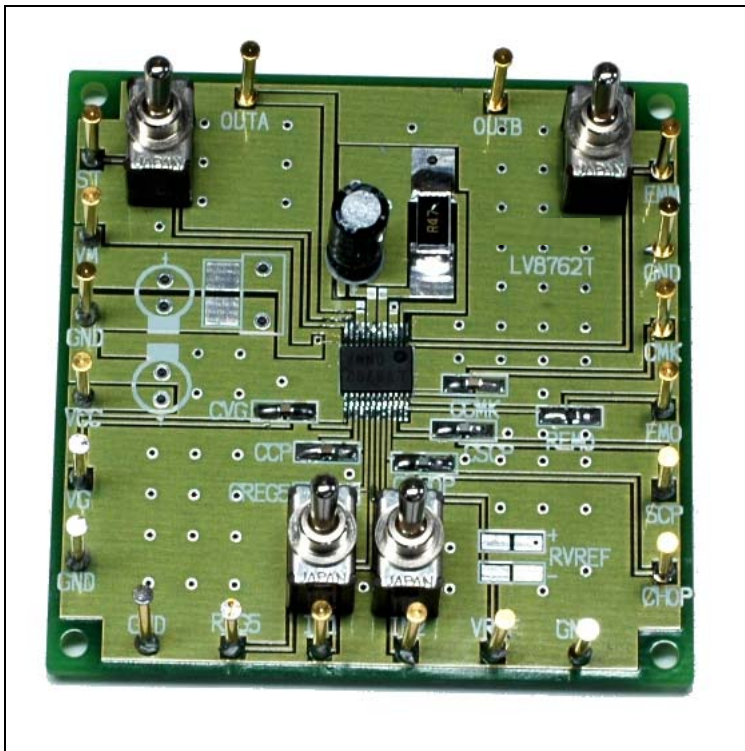

Figure 12 Completed PCB with Devices

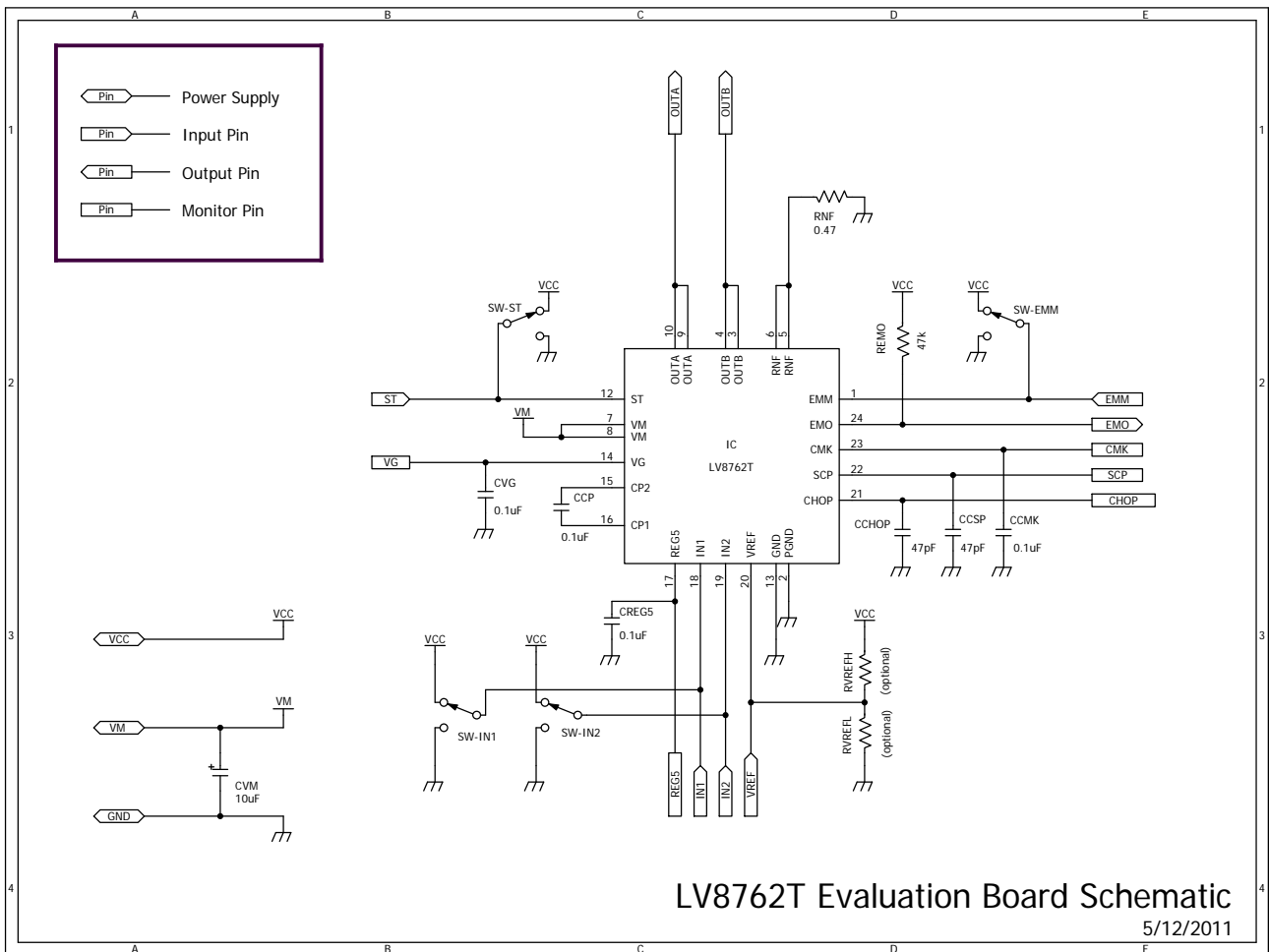

Figure 13 Design Example Schematic

## LV8762T Application Note

---

ON Semiconductor and the ON logo are registered trademarks of Semiconductor Components Industries, LLC (SCILLC). SCILLC owns the rights to a number of patents, trademarks, copyrights, trade secrets, and other intellectual property. A listing of SCILLC's product/patent coverage may be accessed at [www.onsemi.com/site/pdf/Patent-Marking.pdf](http://www.onsemi.com/site/pdf/Patent-Marking.pdf). SCILLC reserves the right to make changes without further notice to any products herein. SCILLC makes no warranty, representation or guarantee regarding the suitability of its products for any particular purpose, nor does SCILLC assume any liability arising out of the application or use of any product or circuit, and specifically disclaims any and all liability, including without limitation special, consequential or incidental damages. "Typical" parameters which may be provided in SCILLC data sheets and/or specifications can and do vary in different applications and actual performance may vary over time. All operating parameters, including "Typicals" must be validated for each customer application by customer's technical experts. SCILLC does not convey any license under its patent rights nor the rights of others. SCILLC products are not designed, intended, or authorized for use as components in systems intended for surgical implant into the body, or other applications intended to support or sustain life, or for any other application in which the failure of the SCILLC product could create a situation where personal injury or death may occur. Should Buyer purchase or use SCILLC products for any such unintended or unauthorized application, Buyer shall indemnify and hold SCILLC and its officers, employees, subsidiaries, affiliates, and distributors harmless against all claims, costs, damages, and expenses, and reasonable attorney fees arising out of, directly or indirectly, any claim of personal injury or death associated with such unintended or unauthorized use, even if such claim alleges that SCILLC was negligent regarding the design or manufacture of the part. SCILLC is an Equal Opportunity/Affirmative Action Employer. This literature is subject to all applicable copyright laws and is not for resale in any manner.