

FEATURES

- Wide input voltage range: 2.85 V to 15 V
- Adjustable negative output to $V_{IN} - 39$ V
- Integrated 2.4 A main switch
- 1.2 MHz/2.4 MHz switching frequency with optional external frequency synchronization from 1.0 MHz to 2.6 MHz
- Resistor programmable soft start timer
- Slew rate control for lower system noise
- Precision enable control
- Power-good output
- UVLO, OCP, OVP, and TSD protection
- 3 mm × 3 mm, 16-lead LFCSP
- 40°C to +125°C junction temperature
- Supported by the [ADIsimPower](#) tool set

APPLICATIONS

- Bipolar amplifiers, ADCs, digital-to-analog converters (DACs), and multiplexers
- High speed converters
- Radio frequency (RF) power amplifier (PA) bias
- Optical modules

GENERAL DESCRIPTION

The [ADP5074](#) is a high performance dc-to-dc inverting regulator used to generate negative supply rails.

The input voltage range of 2.85 V to 15 V supports a wide variety of applications. The integrated main switch enables the generation of an adjustable negative output voltage down to 39 V below the input voltage.

The [ADP5074](#) operates at a pin selected 1.2 MHz/2.4 MHz switching frequency. The [ADP5074](#) can synchronize with an external oscillator from 1.0 MHz to 2.6 MHz to ease noise filtering in sensitive applications. The regulator implements programmable slew rate control circuitry for the MOSFET driver stage to reduce electromagnetic interference (EMI).

The [ADP5074](#) includes a fixed internal or resistor programmable soft start timer to prevent inrush current at power-up. During shutdown, the regulator completely disconnects the load from the input supply to provide a true shutdown. A power good pin is available to indicate the output is stable.

TYPICAL APPLICATION CIRCUIT

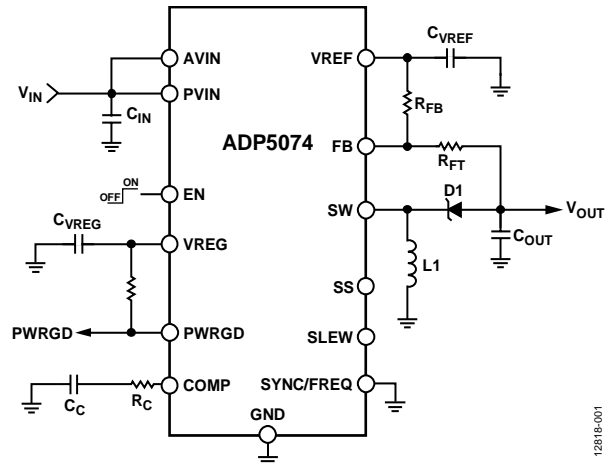

Figure 1.

122818-001

Other key safety features in the [ADP5074](#) include overcurrent protection (OCP), overvoltage protection (OVP), thermal shutdown (TSD), and input undervoltage lockout (UVLO).

The [ADP5074](#) is available in a 16-lead LFCSP and is rated for a -40°C to +125°C operating junction temperature range.

Table 1. Related Devices

Device	Boost Switch (A)	Inverter Switch (A)	Package
ADP5070	1.0	0.6	20-lead LFCSP (4 mm × 4 mm) and TSSOP
ADP5071	2.0	1.2	20-lead LFCSP (4 mm × 4 mm) and TSSOP
ADP5073	Not applicable	1.2	16-lead LFCSP (3 mm × 3 mm)
ADP5074	Not applicable	2.4	16-lead LFCSP (3 mm × 3 mm)
ADP5075	Not applicable	0.8	12-ball WLCSP (1.61 mm × 2.18 mm)

ADP5074* PRODUCT PAGE QUICK LINKS

Last Content Update: 02/23/2017

COMPARABLE PARTS

View a parametric search of comparable parts.

EVALUATION KITS

- ADP5074 Evaluation Board

DOCUMENTATION

Data Sheet

- ADP5074: 2.4 A, DC-to-DC Inverting Regulator Data Sheet

TOOLS AND SIMULATIONS

- ADP5073/ADP5074/ADP5075 Design Tool

DESIGN RESOURCES

- ADP5074 Material Declaration
- PCN-PDN Information
- Quality And Reliability
- Symbols and Footprints

DISCUSSIONS

View all ADP5074 EngineerZone Discussions.

SAMPLE AND BUY

Visit the product page to see pricing options.

TECHNICAL SUPPORT

Submit a technical question or find your regional support number.

DOCUMENT FEEDBACK

Submit feedback for this data sheet.

TABLE OF CONTENTS

Features	1	Internal Regulators	10
Applications	1	Precision Enabling	11
Typical Application Circuit	1	Soft Start	11
General Description	1	Slew Rate Control	11
Revision History	2	Current-Limit Protection	11
Specifications	3	Overvoltage Protection	11
Absolute Maximum Ratings	5	Power Good	11
Thermal Resistance	5	Applications Information	12
ESD Caution	5	ADIsimPower Design Tool	12
Pin Configuration and Function Descriptions	6	Component Selection	12
Typical Performance Characteristics	7	Common Applications	15
Theory of Operation	10	Layout Considerations	16
PWM Mode	10	Outline Dimensions	17
Skip Mode	10	Ordering Guide	17
Undervoltage Lockout (UVLO)	10		
Oscillator and Synchronization	10		

REVISION HISTORY

10/15—Revision 0: Initial Version

SPECIFICATIONS

PVIN = AVIN = 2.85 V to 15 V, V_{OUT} = -15 V, f_{sw} = 1200 kHz, T_J = -40°C to +125°C for minimum/maximum specifications, and T_A = 25°C for typical specifications, unless otherwise noted.

Table 2.

Parameter	Symbol	Min	Typ	Max	Unit	Test Conditions/Comments
INPUT SUPPLY VOLTAGE RANGE	V _{IN}	2.85		15	V	PVIN, AVIN
QUIESCENT CURRENT						
Operating Quiescent Current PVIN, AVIN (Total)	I _Q		1.8	4.0	mA	No switching, EN = high, PVIN = AVIN = 5 V
Shutdown Current	I _{SHDN}		5	10	μA	No switching, EN = low, PVIN = AVIN = 5 V, -40°C ≤ T _J ≤ +85°C
UVLO						AVIN
System UVLO Threshold						
Rising	V _{UVLO_RISING}		2.8	2.85	V	
Falling	V _{UVLO_FALLING}	2.5	2.55		V	
Hysteresis	V _{HYS}		0.25		V	
OSCILLATOR CIRCUIT						
Switching Frequency	f _{sw}	1.130	1.200	1.270	MHz	SYNC/FREQ = low
		2.240	2.400	2.560	MHz	SYNC/FREQ = high (connect to VREG)
SYNC/FREQ Input						
Input Clock Range	f _{SYNC}	1.000		2.600	MHz	
Input Clock Minimum On Pulse Width	t _{SYNC_MIN_ON}	100			ns	
Input Clock Minimum Off Pulse Width	t _{SYNC_MIN_OFF}	100			ns	
Input Clock High Logic	V _{H (SYNC)}			1.3	V	
Input Clock Low Logic	V _{L (SYNC)}	0.4			V	
PRECISION ENABLING (EN)						
High Level Threshold	V _{TH_H}	1.125	1.15	1.175	V	
Low Level Threshold	V _{TH_L}	1.025	1.05	1.075	V	
Shutdown Mode	V _{TH_S}	0.4			V	Internal circuitry disabled to achieve I _{SHDN}
Pull-Down Resistance	R _{EN}		1.48		MΩ	
INTERNAL REGULATOR						
VREG Output Voltage	V _{REG}		4.25		V	
INVERTING REGULATOR						
Reference Voltage	V _{REF}		1.60		V	
Accuracy		-0.5		+0.5	%	T _J = 25°C
		-1.5		+1.5	%	T _J = -40°C to +125°C
Feedback Voltage	V _{REF} - V _{FB}		0.8		V	
Accuracy		-0.5		+0.5	%	T _J = 25°C
		-1.5		+1.5	%	T _J = -40°C to +125°C
Feedback Bias Current	I _{FB}			0.1	μA	
Overvoltage Protection Threshold	V _{OV}		0.74		V	At the FB pin after soft start is complete
Power-Good Threshold	V _{PG (GOOD)}		0.7		V	V _{REF} - V _{FB} ≥ V _{PG (GOOD)}
	V _{PG (BAD)}		0.68		V	V _{REF} - V _{FB} ≤ V _{PG (BAD)}
Power-Good FET On Resistance	R _{DS_PG (ON)}		28		Ω	
Power-Good FET Maximum Drain Source Voltage	V _{DS_PG (MAX)}			5.5	V	
Power-Good Supply Voltage	V _{PG (SUPPLY)}		1.4			Voltage required on PVIN pin for power-good FET to pull down
Load Regulation	Δ(V _{REF} - V _{FB})/ ΔI _{LOAD}		0.0006		%/A	I _{LOAD} = 20 mA to 1500 mA (regulator not in skip mode)
Line Regulation	Δ(V _{REF} - V _{FB})/ ΔV _{VIN}		0.02		%/V	V _{VIN} = 2.85 V to 14.5 V, I _{LOAD} = 15 mA (regulator not in skip mode)

Parameter	Symbol	Min	Typ	Max	Unit	Test Conditions/Comments
Error Amplifier (EA) Transconductance	g_M	270	300	330	$\mu\text{A}/\text{V}$	$V_{\text{IN}} = 5\text{ V}$
Power FET On Resistance	$R_{\text{DS(ON)}}$		200		$\text{m}\Omega$	
Power FET Maximum Drain Source Voltage	$V_{\text{DS(MAX)}}$			39	V	
Current-Limit Threshold	I_{LIM}	2.4	2.75	3.2	A	
Minimum On Time			55		ns	
Minimum Off Time			50		ns	
SOFT START						
Soft Start Timer	t_{SS}		4		ms	SS = open SS resistor = 50 k Ω to GND
			32		ms	
Hiccup Time	t_{HICCUP}		$8 \times t_{\text{SS}}$		ms	
THERMAL SHUTDOWN						
Threshold	T_{SHDN}		150		$^{\circ}\text{C}$	
Hysteresis	T_{HYS}		15		$^{\circ}\text{C}$	

ABSOLUTE MAXIMUM RATINGS

Table 3.

Parameter	Rating
PVIN, AVIN	-0.3 V to +18 V
SW	PVIN - 40 V to PVIN + 0.3 V
GND	-0.3 V to +0.3 V
VREG	-0.3 V to lower of AVIN + 0.3 V or +6 V
EN, FB, SYNC/FREQ, PWRGD	-0.3 V to +6 V
COMP, SLEW, SS, VREF	-0.3 V to VREG + 0.3 V
Operating Junction Temperature Range	-40°C to +125°C
Storage Temperature Range	-65°C to +150°C
Soldering Conditions	JEDEC J-STD-020

Stresses at or above those listed under Absolute Maximum Ratings may cause permanent damage to the product. This is a stress rating only; functional operation of the product at these or any other conditions above those indicated in the operational section of this specification is not implied. Operation beyond the maximum operating conditions for extended periods may affect product reliability.

THERMAL RESISTANCE

θ_{JA} and Ψ_{JT} are based on a 4-layer printed circuit board (PCB) (two signals and two power planes) with thermal vias connecting the exposed pad to a ground plane as recommended in the Layout Considerations section. θ_{JC} is measured at the top of the package and is independent of the PCB. The Ψ_{JT} value is more appropriate for calculating junction to case temperature in the application.

Table 4. Thermal Resistance

Package Type	θ_{JA}	θ_{JC}	Ψ_{JT}	Unit
16-Lead LFCSP	75.01	55.79	0.95	°C/W

ESD CAUTION



ESD (electrostatic discharge) sensitive device. Charged devices and circuit boards can discharge without detection. Although this product features patented or proprietary protection circuitry, damage may occur on devices subjected to high energy ESD. Therefore, proper ESD precautions should be taken to avoid performance degradation or loss of functionality.

PIN CONFIGURATION AND FUNCTION DESCRIPTIONS

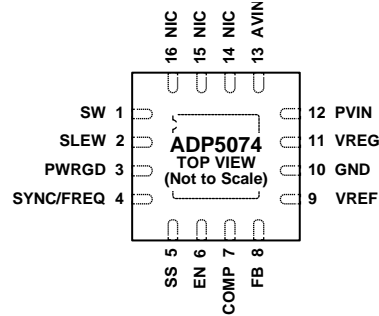

NOTES.

1. NIC = NO INTERNAL CONNECTION. FOR IMPROVED THERMAL PERFORMANCE, CONNECT THESE PINS TO THE PCB GROUND PLANE.
2. EXPOSED PAD. CONNECT THE EXPOSED PAD TO GND.

12818-002

Figure 2. Pin Configuration

Table 5. Pin Function Descriptions

Pin No.	Mnemonic	Description
1	SW	Switching Node for the Inverting Regulator.
2	SLEW	Driver Stage Slew Rate Control. The SLEW pin sets the slew rate for the FET driving the SW pin. For the fastest slew rate (best efficiency), leave the SLEW pin open. For a normal slew rate, connect the SLEW pin to VREG. For the slowest slew rate (best noise performance), connect the SLEW pin to GND.
3	PWRGD	Power-Good Output (Open-Drain). Pull this pin up to VREG with a resistor to provide a high output when power is good.
4	SYNC/FREQ	Frequency Setting and Synchronization Input. To set the switching frequency to 2.4 MHz, pull the SYNC/FREQ pin high. To set the switching frequency to 1.2 MHz, pull the SYNC/FREQ pin low. To synchronize the switching frequency, connect the SYNC/FREQ pin to an external clock.
5	SS	Soft Start Programming. Leave the SS pin open to obtain the fastest soft start time. To program a slower soft start time, connect a resistor between the SS pin and GND.
6	EN	Inverting Regulator Precision Enable. The EN pin is compared to an internal precision reference to enable the inverting regulator output.
7	COMP	Error Amplifier Compensation for the Inverting Regulator. Connect the compensation network between this pin and GND.
8	FB	Feedback Input for the Inverting Regulator. Connect a resistor divider between the negative side of the inverting regulator output capacitor and VREF to program the output voltage.
9	VREF	Inverting Regulator Reference Output. Connect a 1.0 μ F ceramic filter capacitor between the VREF pin and GND.
10	GND	Ground.
11	VREG	Internal Regulator Output. Connect a 1.0 μ F ceramic filter capacitor between the VREG pin and GND.
12	PVIN	Power Input for the Inverting Regulator.
13	AVIN	System Power Supply for the ADP5074 .
14, 15, 16	NIC	No Internal Connection. For improved thermal performance, connect these pins to the PCB ground plane.
EPAD	EPAD	Exposed Pad. Connect the exposed pad to GND.

TYPICAL PERFORMANCE CHARACTERISTICS

Typical performance characteristics are generated using the standard bill of materials for each input/output combination listed in Table 9.

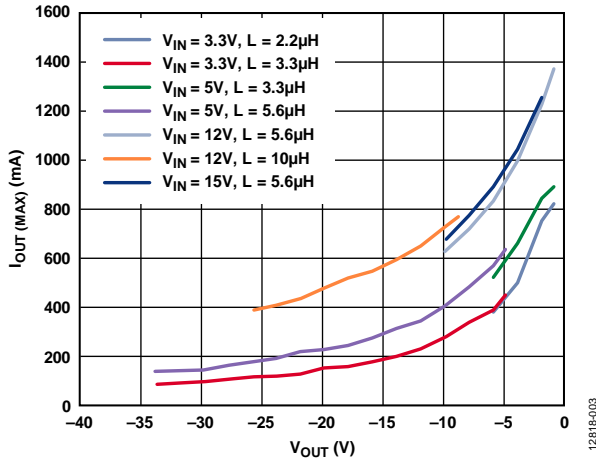

Figure 3. Maximum Output Current, $f_{SW} = 1.2\text{ MHz}$, $T_A = 25^\circ\text{C}$, Based on Target of 70% $I_{LIM(MIN)}$

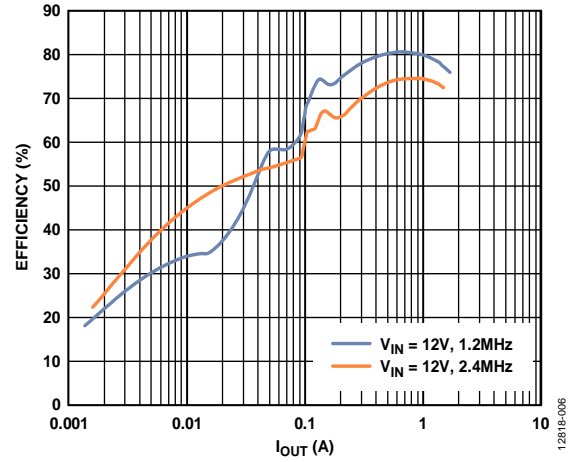

Figure 6. Efficiency vs. Current Load (I_{OUT}), $V_{IN} = 12V$, $V_{OUT} = -5V$, $T_A = 25^\circ\text{C}$

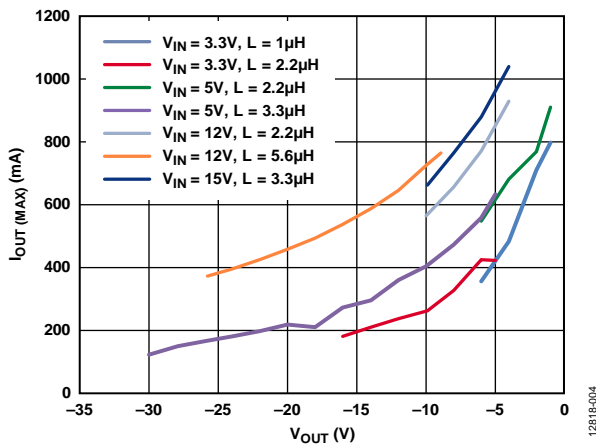

Figure 4. Maximum Output Current, $f_{SW} = 2.4\text{ MHz}$, $T_A = 25^\circ\text{C}$, Based on Target of 70% $I_{LIM(MIN)}$

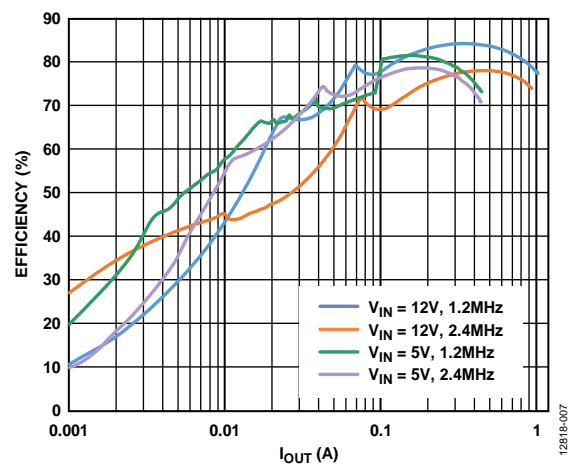

Figure 7. Efficiency vs. Current Load (I_{OUT}), $V_{IN} = 5V$ and $12V$, $V_{OUT} = -15V$, $T_A = 25^\circ\text{C}$

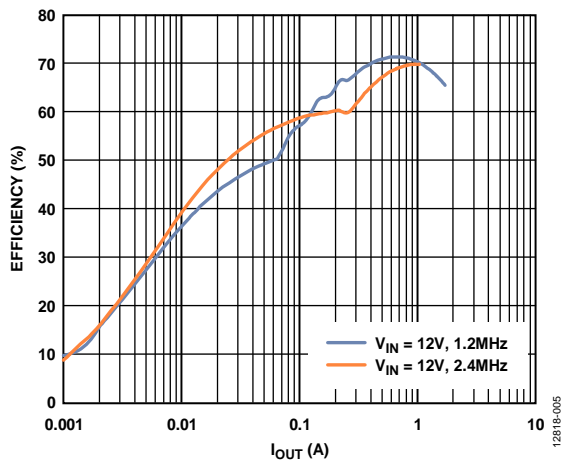

Figure 5. Efficiency vs. Current Load (I_{OUT}), $V_{IN} = 12V$, $V_{OUT} = -2.5V$, $T_A = 25^\circ\text{C}$

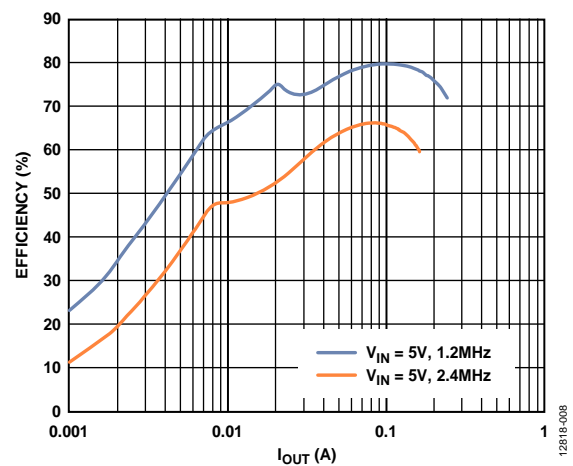

Figure 8. Efficiency vs. Current Load (I_{OUT}), $V_{IN} = 5V$, $V_{OUT} = -30V$, $T_A = 25^\circ\text{C}$

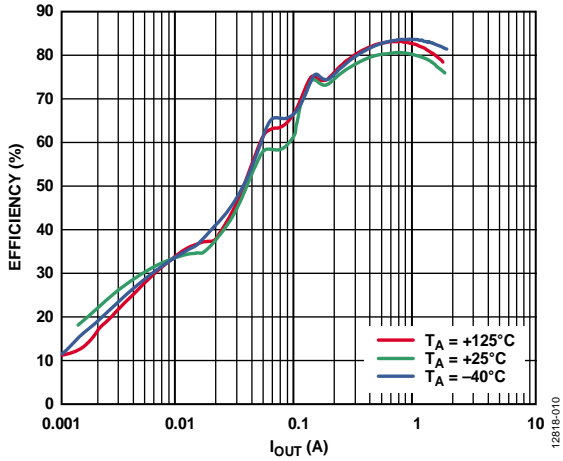

Figure 9. Efficiency vs. Current Load (I_{OUT}) for Various Temperatures, $V_{IN} = 5\text{ V}$, $V_{OUT} = -15\text{ V}$, $f_{SW} = 1.2\text{ MHz}$

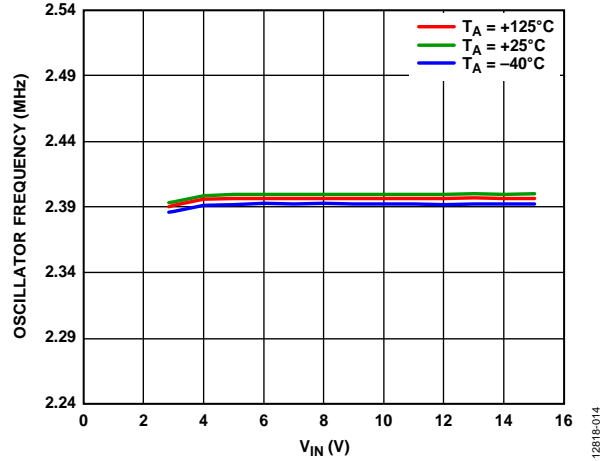

Figure 12. Oscillator Frequency vs. Input Voltage (V_{IN}) for Various Temperatures, SYNC/FREQ Pin = High

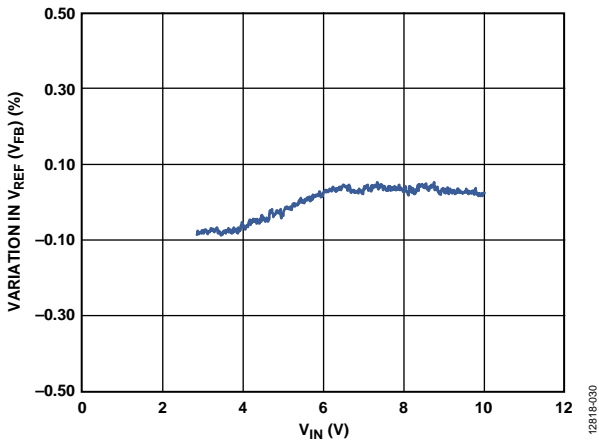

Figure 10. Line Regulation, $V_{OUT} = -5\text{ V}$, $f_{SW} = 1.2\text{ MHz}$, 15 mA Load, $T_A = 25^\circ\text{C}$ (Skip Mode Not Shown)

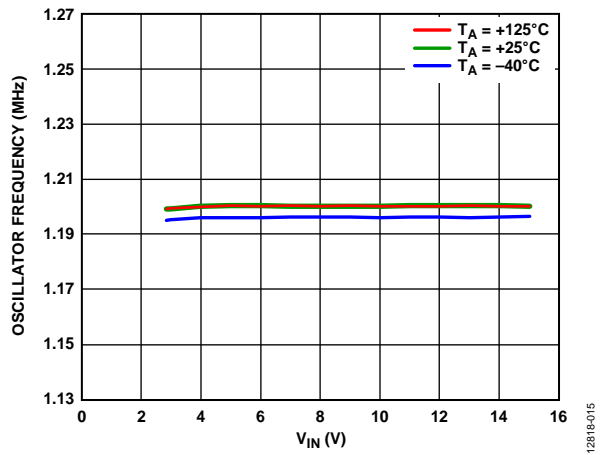

Figure 13. Oscillator Frequency vs. Input Voltage (V_{IN}) for Various Temperatures, SYNC/FREQ Pin = Low

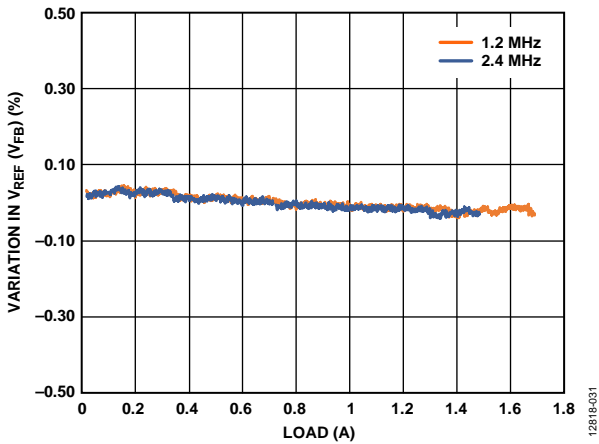

Figure 11. Load Regulation, $V_{IN} = 12\text{ V}$, $V_{OUT} = -5\text{ V}$, $f_{SW} = 1.2\text{ MHz}$, $T_A = 25^\circ\text{C}$ (Skip Mode Not Shown)

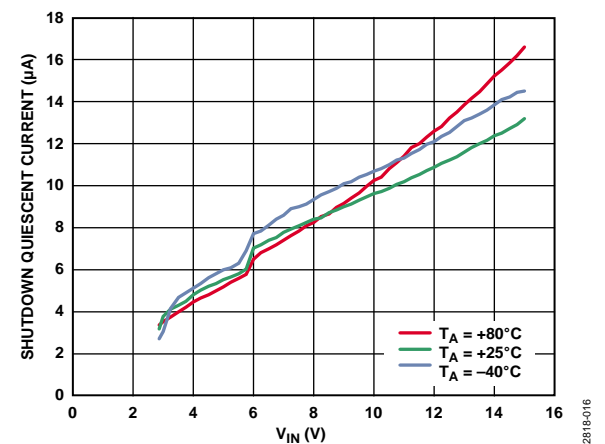

Figure 14. Shutdown Quiescent Current (I_{SHDN}) vs. Input Voltage (V_{IN}) for Various Temperatures, EN Pin Below Shutdown Threshold

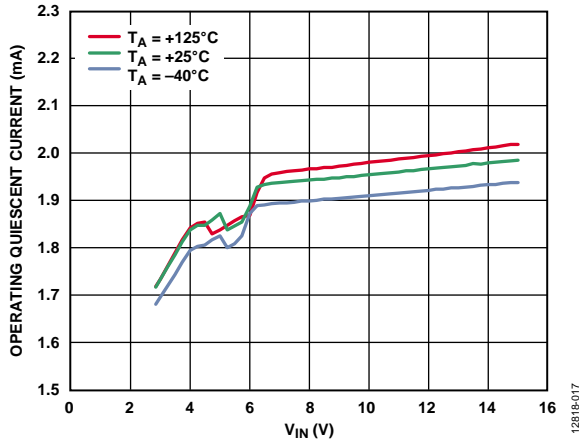

Figure 15. Operating Quiescent Current (I_Q) vs. Input Voltage (V_{IN}) for Various Temperatures, EN Pin On

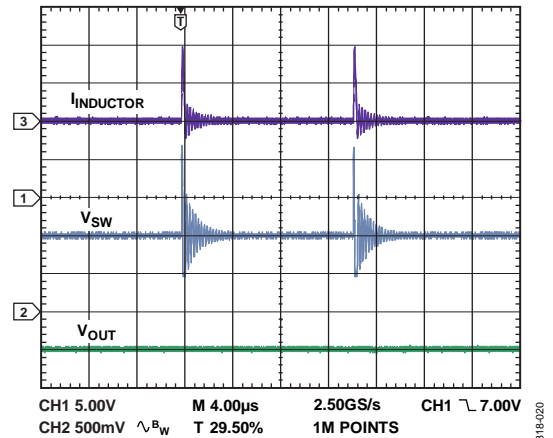

Figure 18. Skip Mode Operation Showing Inductor Current ($I_{INDUCTOR}$), Switch Node Voltage (V_{SW}), and Output Ripple (V_{OUT}), $V_{IN} = 12\text{ V}$, $V_{OUT} = -5\text{ V}$, $I_{LOAD} = 1\text{ mA}$, $f_{SW} = 1.2\text{ MHz}$, $T_A = 25^\circ\text{C}$

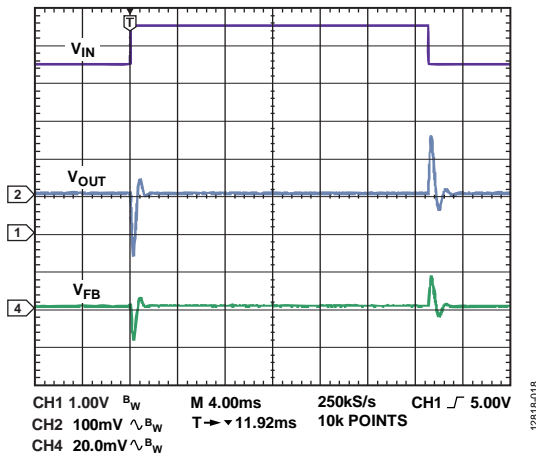

Figure 16. Line Transient Showing V_{IN} , V_{OUT} , and V_{FB} , $V_{IN} = 4.5\text{ V}$ to 5.5 V Step, $V_{OUT} = -5\text{ V}$, $R_{LOAD} = 300\ \Omega$, $f_{SW} = 1.2\text{ MHz}$, $T_A = 25^\circ\text{C}$

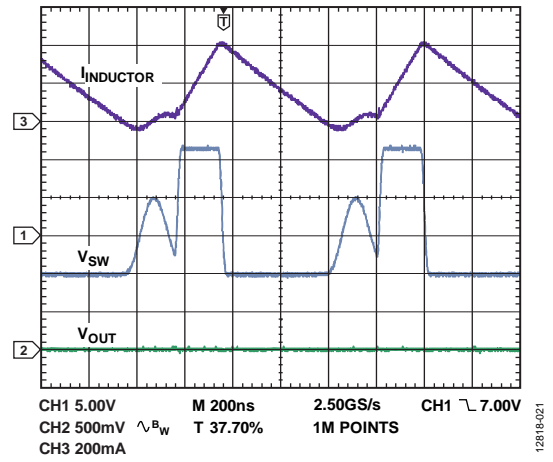

Figure 19. Discontinuous Conduction Mode Operation Showing Inductor Current ($I_{INDUCTOR}$), Switch Node Voltage (V_{SW}), and Output Ripple (V_{OUT}), $V_{IN} = 12\text{ V}$, $V_{OUT} = -5\text{ V}$, $I_{LOAD} = 100\text{ mA}$, $f_{SW} = 1.2\text{ MHz}$, $T_A = 25^\circ\text{C}$

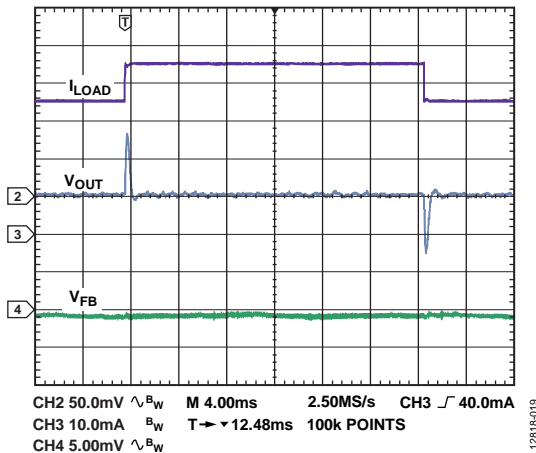

Figure 17. Load Transient Showing I_{LOAD} , V_{OUT} , and V_{FB} , $V_{IN} = 12\text{ V}$, $V_{OUT} = -5\text{ V}$, $I_{LOAD} = 35\text{ mA}$ to 45 mA Step, $f_{SW} = 1.2\text{ MHz}$, $T_A = 25^\circ\text{C}$

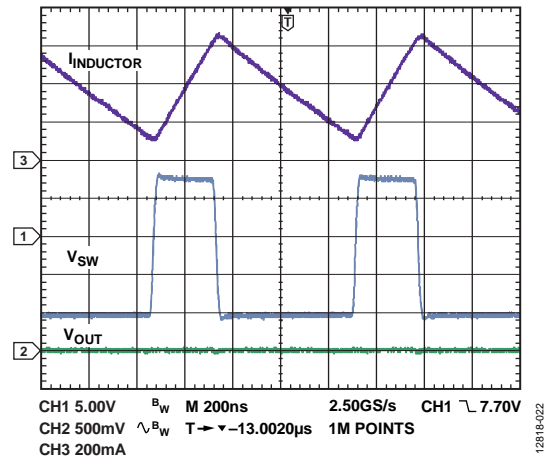

Figure 20. Continuous Conduction Mode Operation Showing Inductor Current ($I_{INDUCTOR}$), Switch Node Voltage (V_{SW}), and Output Ripple (V_{OUT}), $V_{IN} = 12\text{ V}$, $V_{OUT} = -5\text{ V}$, $I_{LOAD} = 250\text{ mA}$, $f_{SW} = 1.2\text{ MHz}$, $T_A = 25^\circ\text{C}$

PRECISION ENABLING

The ADP5074 has an enable pin that features a precision enable circuit with an accurate reference voltage. This reference allows the ADP5074 to be sequenced easily from other supplies. It can also be used as a programmable UVLO input by using a resistor divider.

The enable pin has an internal pull-down resistor that defaults to off when the pin is floating. When the voltage at the enable pin is greater than the $V_{TH,H}$ reference level, the regulator is enabled.

SOFT START

The regulator in the ADP5074 includes soft start circuitry that ramps the output voltage in a controlled manner during startup, thereby limiting the inrush current. The soft start time is internally set to the fastest rate when the SS pin is open.

Connecting a resistor between SS and ground allows the adjustment of the soft start delay.

SLEW RATE CONTROL

The ADP5074 uses programmable output driver slew rate control circuitry. This circuitry reduces the slew rate of the switching node as shown in Figure 22, resulting in reduced ringing and lower EMI. To program the slew rate, connect the SLEW pin to the VREG pin for normal mode, to the GND pin for slow mode, or leave it open for fast mode. This logic allows the use of an open-drain output from a noise sensitive device to switch the slew rate from fast to slow, for example, during analog-to-digital converter (ADC) sampling.

Note that slew rate control causes a trade-off between efficiency and low EMI.

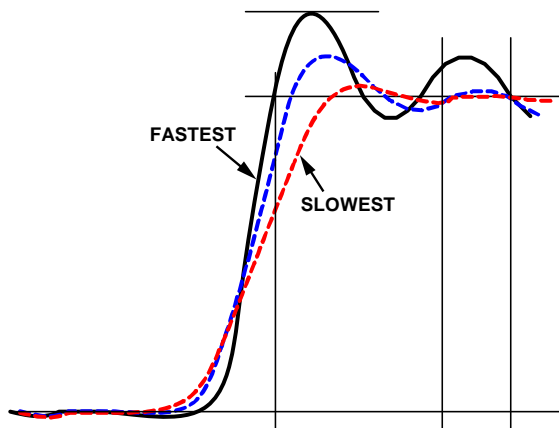

Figure 22. Switching Node at Various Slew Rate Settings

CURRENT-LIMIT PROTECTION

The inverting regulator in the ADP5074 includes current-limit protection circuitry to limit the amount of forward current allowed through the MOSFET switch.

When the peak inductor current exceeds the current-limit threshold, the power MOSFET switch is turned off for the remainder of that switch cycle. If the peak inductor current continues to exceed the overcurrent limit, the regulator enters hiccup mode. The regulator stops switching and then restarts with a new soft start cycle after t_{HICCUP} and repeats until the overcurrent condition is removed.

OVERVOLTAGE PROTECTION

An overvoltage protection mechanism is present on the FB pin for the inverting regulator.

When the voltage on the FB pin drops below the V_{OV} threshold, the switching stops until the voltage rises above the threshold. This functionality is enabled after the soft start period has elapsed.

POWER GOOD

The ADP5074 provides an open-drain power-good output to indicate when the output voltage reaches a target level.

A pull-up voltage must be provided on the PWRGD pin through an external resistor to provide a high output when the power is good. The pull-up voltage is typically sourced from the VREG pin although an external supply may be used with a maximum voltage of $V_{DS,PG(MAX)}$. The power-good FET pulls down when the supply on the PVIN pin rises above $V_{PG(SUPPLY)}$ and the FET remains on until the enable is brought high and soft start has completed. Note that if an external supply is used, the power-good output may be high until PVIN reaches $V_{DS,PG(MAX)}$.

As soon as the device is enabled and soft start is complete, the power-good function monitors the voltage on the FB pin. If the voltage $V_{REF} - V_{FB}$ is greater than the $V_{PG(GOOD)}$ threshold, the power-good FET turns off, allowing the power-good output to be pulled up to VREG or an external supply signaling a power-good valid condition. If the voltage $V_{REF} - V_{FB}$ is less than the $V_{PG(BAD)}$ threshold, the power-good FET turns on, pulling the output to GND, indicating the power output is not good.

THERMAL SHUTDOWN

In the event that the ADP5074 junction temperature rises above T_{SHDN} , the thermal shutdown circuit turns off the IC. Extreme junction temperatures can be the result of prolonged high current operation, poor circuit board design, and/or high ambient temperature. Hysteresis is included so that when thermal shutdown occurs, the ADP5074 does not return to operation until the on-chip temperature drops below $T_{SHDN} - T_{HYS}$. When resuming from thermal shutdown, a soft start is performed.

APPLICATIONS INFORMATION

ADIsimPOWER DESIGN TOOL

The ADP5074 is supported by the ADIsimPower™ design tool set. ADIsimPower is a collection of tools that produce complete power designs optimized to a specific design goal. These tools allow the user to generate a full schematic, bill of materials, and calculate performance in minutes. ADIsimPower can optimize designs for cost, area, efficiency, and device count while taking into consideration the operating conditions and limitations of the IC and all real external components. The ADIsimPower tool can be found at www.analog.com/adisimpower, and the user can request an unpopulated board through the tool.

COMPONENT SELECTION

Feedback Resistors

The ADP5074 provides an adjustable output voltage. An external resistor divider sets the output voltage, where the divider output must equal the feedback reference voltage, V_{FB} . To limit the output voltage accuracy degradation due to feedback bias current, ensure that the current through the divider is at least $10 \times I_{FB}$.

Set the negative output for the inverting regulator by

$$V_{OUT} = V_{FB} - \frac{R_{FT}}{R_{FB}}(V_{REF} - V_{FB})$$

where:

V_{OUT} is the negative output voltage.

V_{FB} is the FB reference voltage.

R_{FT} is the feedback resistor from V_{OUT} to FB.

R_{FB} is the feedback resistor from FB to VREF.

V_{REF} is the VREF pin reference voltage.

Table 7 shows recommended values for common output voltages using standard resistor values.

Table 7. Recommended Feedback Resistor Values

Desired Output Voltage (V)	R_{FT} (MΩ)	R_{FB} (kΩ)	Actual Output Voltage (V)
-1.8	0.332	102	-1.804
-3	0.475	100	-3.000
-3.3	0.523	102	-3.302
-4.2	0.715	115	-4.174
-5	1.15	158	-5.023
-9	1.62	133	-8.944
-12	1.15	71.5	-12.067
-13	2.8	162	-13.027
-15	2.32	118	-14.929
-18	2.67	113	-18.103
-20	2.94	113	-20.014
-24	3.16	102	-23.984
-30	4.12	107	-30.004
-35	5.11	115	-34.748

Output Capacitor

Higher output capacitor values reduce the output voltage ripple and improve load transient response. When choosing this value, it is also important to account for the loss of capacitance due to the output voltage dc bias.

Ceramic capacitors are manufactured with a variety of dielectrics, each with a different behavior over temperature and applied voltage. Capacitors must have a dielectric adequate to ensure the minimum capacitance over the necessary temperature range and dc bias conditions. X5R or X7R dielectrics with a voltage rating of 25 V or 50 V (depending on output) are recommended for best performance. Y5V and Z5U dielectrics are not recommended for use with any dc-to-dc converter because of their poor temperature and dc bias characteristics.

Calculate the worst case capacitance accounting for capacitor variation over temperature, component tolerance, and voltage using the following equation:

$$C_{EFFECTIVE} = C_{NOMINAL} \times (1 - TEMPCO) \times (1 - DCBIASCO) \times (1 - Tolerance)$$

where:

$C_{EFFECTIVE}$ is the effective capacitance at the operating voltage.

$C_{NOMINAL}$ is the nominal data sheet capacitance.

$TEMPCO$ is the worst case capacitor temperature coefficient.

$DCBIASCO$ is the dc bias derating at the output voltage.

$Tolerance$ is the worst case component tolerance.

To guarantee the performance of the device, it is imperative that the effects of dc bias, temperature, and tolerances on the behavior of the capacitors be evaluated for each application.

Capacitors with lower effective series resistance (ESR) and effective series inductance (ESL) are preferred to minimize output voltage ripple.

Note that the use of large output capacitors may require a slower soft start to prevent current limit during startup. A 10 μF capacitor is suggested as a good balance between performance and size.

Input Capacitor

Higher value input capacitors help reduce the input voltage ripple and improve transient response.

To minimize supply noise, place the input capacitor as close as possible to the AVIN and PVIN pins. A low ESR capacitor is recommended.

For stability, the use of a good quality 10 μF ceramic capacitor with low dc bias effects is recommended. If the power pins are individually decoupled, it is recommended to use a minimum of a 5.6 μF capacitor on the PVIN pin and a 3.3 μF capacitor on the AVIN pin.

VREG Capacitor

A 1.0 μF ceramic capacitor (C_{VREG}) is required between the VREG pin and GND.

VREF Capacitor

A 1.0 μF ceramic capacitor (C_{VREF}) is required between the VREF pin and GND.

Soft Start Resistor

A resistor (R_{SS}) can be connected between the SS pin and the GND pin to increase the soft start time. The soft start time can be set using this resistor between 4 ms (268 k Ω) and 32 ms (50 k Ω). Leaving the SS pin open selects the fastest time of 4 ms. Figure 23 shows the behavior of this operation. Calculate the soft start time (t_{SS}) using the following formula:

$$t_{SS} = 38.4 \times 10^{-3} - 1.28 \times 10^{-7} \times R_{SS} (\Omega)$$

where $50 \text{ k}\Omega \leq R_{SS} \leq 268 \text{ k}\Omega$.

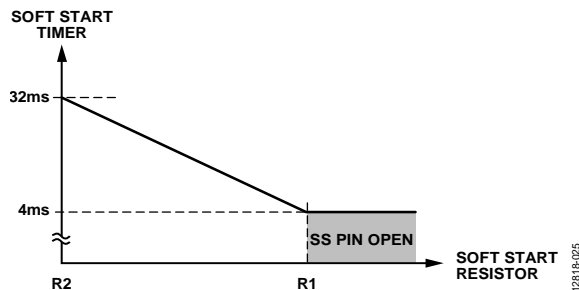

Figure 23. Soft Start Behavior

Diodes

A Schottky diode with low junction capacitance is recommended for D1. At higher output voltages and especially at higher switching frequencies, the junction capacitance is a significant contributor to efficiency. Higher capacitance diodes also generate more switching noise. As a guide, a diode with less than 40 pF junction capacitance is preferred when the output voltage is in the range of -5 V to -37 V .

Inductor Selection

The inductor stores energy during the on time of the power switch, and transfers that energy to the output through the output rectifier during the off time. To balance the trade-offs between small inductor current ripple and efficiency, inductance values in the range of 1 μH to 22 μH are recommended. In general, lower inductance values have higher saturation current and lower series resistance for a given physical size. However, lower inductance results in a higher peak current that can lead to reduced efficiency and greater input and/or output ripple and noise. A peak-to-peak inductor ripple current close to 30% of the maximum dc current in the inductor typically yields an optimal compromise.

For the smallest solution size, inductors with a saturation current below I_{LIM} may be used when the output current in the application is such that the inductor current stays below the saturated region.

For the inductor ripple current in continuous conduction mode (CCM) operation, the input (V_{IN}) and output (V_{OUT}) voltages determine the switch duty cycle (Duty) by the following equation:

$$Duty = \left(\frac{|V_{OUT}| + V_{DIODE}}{V_{IN} + |V_{OUT}| + V_{DIODE}} \right)$$

where V_{DIODE} is the forward voltage drop of the Schottky diode (D1).

Determine the dc current in the inductor in CCM (I_{LI}) using the following equation:

$$I_{LI} = \frac{I_{OUT}}{(1 - Duty)}$$

Using the duty cycle (Duty) and switching frequency (f_{sw}), determine the on time (t_{ON}) using the following equation:

$$t_{ON} = \frac{Duty}{f_{sw}}$$

The inductor ripple current (ΔI_{LI}) in steady state is calculated by

$$\Delta I_{LI} = \frac{V_{IN} \times t_{ON}}{LI}$$

Solve for the inductance value (LI) using the following equation:

$$LI = \frac{V_{IN} \times t_{ON}}{\Delta I_{LI}}$$

Assuming an inductor ripple current of 30% of the maximum dc current in the inductor results in

$$LI = \frac{V_{IN} \times t_{ON} \times (1 - Duty)}{0.3 \times I_{OUT}}$$

Ensure that the peak inductor current (the maximum input current plus half the inductor ripple current) is below the rated saturation current of the inductor. Likewise, ensure that the maximum rated rms current of the inductor is greater than the maximum dc input current to the regulator.

When operating the ADP5074 inverting regulator in CCM, for stable current mode operation, ensure that the selected inductance is equal to or greater than the minimum calculated inductance, L_{MIN} , for the application parameters in the following equation:

$$LI > L_{MIN} = V_{IN} \times \left(\frac{0.13}{(1 - Duty)} - 0.16 \right) (\mu\text{H})$$

Table 9 suggests a series of inductors to use with the ADP5074 inverting regulator.

Loop Compensation

The ADP5074 uses external components to compensate the regulator loop, allowing the optimization of the loop dynamics for a given application. It is recommended to use the ADIsimPower tool to calculate compensation components.

The inverting converter, produces a right half plane zero in the regulation feedback loop. This feedback loop requires compensating the regulator such that the crossover frequency occurs well below the frequency of the right half plane zero. The right half plane zero frequency is determined by the following equation:

$$f_z (RHP) = \frac{R_{LOAD}(1 - Duty)^2}{2\pi \times L1 \times Duty}$$

where:

$f_z (RHP)$ is the right half plane zero frequency.

R_{LOAD} is the equivalent load resistance or the output voltage divided by the load current.

$$Duty = \left(\frac{|V_{OUT}| + V_{DIODE}}{V_{IN} + |V_{OUT}| + V_{DIODE}} \right)$$

where V_{DIODE} is the forward voltage drop of the Schottky diode (D1).

To stabilize the regulator, ensure that the regulator crossover frequency is less than or equal to one-tenth of the right half plane zero frequency.

The regulator loop gain is

$$A_{VL} = \frac{V_{FB}}{|V_{OUT}|} \times \frac{V_{IN}}{(V_{IN} + 2 \times |V_{OUT}|)} \times G_M \times |R_{OUT}||Z_{COMP}| \times G_{CS} \times |Z_{OUT}|$$

where:

A_{VL} is the regulator loop gain.

V_{FB} is the feedback regulation voltage.

V_{OUT} is the regulated negative output voltage.

V_{IN} is the input voltage.

G_M is the error amplifier transconductance gain.

R_{OUT} is the output impedance of the error amplifier and is 33 MΩ.

Z_{COMP} is the impedance of the series RC network from COMP to GND.

G_{CS} is the current sense transconductance gain (the inductor current divided by the voltage at COMP), which is internally set by the ADP5074 and is 12.5 A/V.

Z_{OUT} is the impedance of the load in parallel with the output capacitor.

To determine the crossover frequency, it is important to note that, at that frequency, the compensation impedance (Z_{COMP}) is dominated by a resistor, R_C , and the output impedance (Z_{OUT}) is dominated by the impedance of the output capacitor (C_{OUT}).

Therefore, when solving for the crossover frequency, the equation (by definition of the crossover frequency) is simplified to

$$|A_{VL}| = \frac{V_{FB}}{|V_{OUT}|} \times \frac{V_{IN}}{(V_{IN} + 2 \times |V_{OUT}|)} \times G_M \times R_C \times G_{CS} \times \frac{1}{2\pi \times f_c \times C_{OUT}} = 1$$

where f_c is the crossover frequency.

To solve for R_C , use the following equation:

$$R_C = \frac{2\pi \times f_c \times C_{OUT} \times |V_{OUT}| \times (V_{IN} + (2 \times |V_{OUT}|))}{V_{FB} \times V_{IN} \times G_M \times G_{CS}}$$

where $G_{CS} = 12.5$ A/V.

Using typical values for V_{FB} and G_M results in

$$R_C = \frac{2094 \times f_c \times C_{OUT} \times |V_{OUT}| \times (V_{IN} + (2 \times |V_{OUT}|))}{V_{IN}}$$

For better accuracy, it is recommended to use the value of output capacitance (C_{OUT}) that takes into account the capacitance reduction from dc bias in the calculation for R_C .

After the compensation resistor is known, set the zero formed by C_C and R_C to one-fourth of the crossover frequency, or

$$C_C = \frac{2}{\pi \times f_c \times R_C}$$

where C_C is the compensation capacitor.

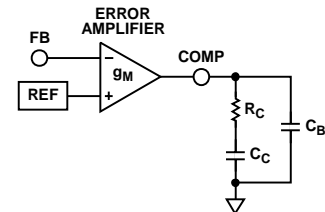

Figure 24. Compensation Components

The optional capacitor, C_B , is chosen to cancel the zero introduced by the ESR of the output capacitor. For low ESR capacitors such as ceramic chip capacitors, C_B can be omitted from the design.

Solve for C_B as follows:

$$C_B = \frac{ESR \times C_{OUT}}{R_C}$$

For optimal transient performance, R_C and C_C may need to be adjusted by observing the load transient response of the ADP5074. For most applications, R_C is within the range of 1 kΩ to 200 kΩ, and C_C is within the range of 1 nF to 68 nF.

COMMON APPLICATIONS

Table 8 and Table 9 list a number of common component selections for typical V_{IN} and V_{OUT} conditions. These have been bench tested and provide an off the shelf solution. To optimize components for an application, it is recommended to use the [ADIsimPower](#) tool set.

Figure 25 shows the schematic referenced by Table 8 and Table 9 with example component values for a +5 V input to a -5 V

output. Table 8 shows the components common to all V_{IN} and V_{OUT} conditions.

Table 8. Recommended Common Components Selections

Reference	Value (μF)	Part Number	Manufacturer
C_{IN}	10	TMK316B7106KL-TD	Taiyo Yuden
C_{VREG}	1	GRM188R71A105KA61D	Murata
C_{VREF}	1	GRM188R71A105KA61D	Murata

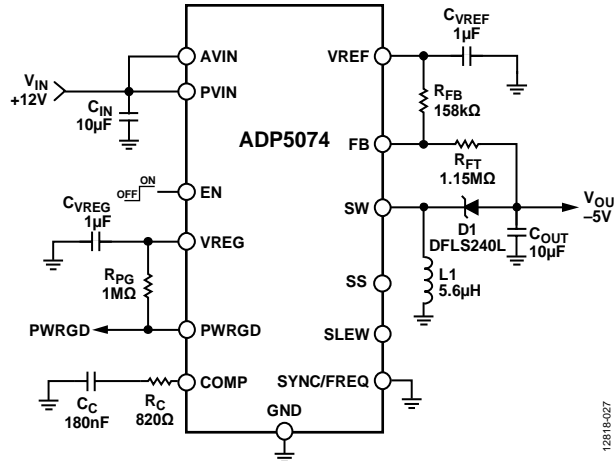

Figure 25. Typical +12 V Input to -5 V Output, 1.2 MHz Application

Table 9. Recommended Inverting Regulator Components

V_{IN} (V)	V_{OUT} (V)	Freq. (MHz)	L1 (μH)	L1, Coilcraft® Part	C_{OUT} (μF)	C_{OUT} , Murata Part	D1, Diodes, Inc., Part	R_{FT} (M Ω)	R_{FB} (k Ω)	C_C (nF)	R_C (k Ω)
3.3	-2.5	1.2	2.2	XAL4020-222ME_	10	GRM32ER71H106KA12L	DFLS240L	0.432	107	270	0.56
3.3	-2.5	2.4	1	XAL4020-102ME_	10	GRM32ER71H106KA12L	DFLS240L	0.432	107	47	1.3
3.3	-3.3	1.2	2.2	XAL4020-222ME_	10	GRM32ER71H106KA12L	DFLS240L	0.532	102	120	1
3.3	-3.3	2.4	1.2	XAL4020-122ME_	10	GRM32ER71H106KA12L	DFLS240L	0.532	102	33	2
3.3	-5	1.2	2.2	XAL4020-222ME_	10	GRM32ER71H106KA12L	DFLS240L	1.15	158	39	2.7
3.3	-5	2.4	1.5	XAL4020-152ME_	10	GRM32ER71H106KA12L	DFLS240L	1.15	158	22	3.6
5	-5	1.2	3.3	XAL4030-332ME_	10	GRM32ER71H106KA12L	DFLS240L	1.15	158	82	1.6
5	-5	2.4	2.2	XAL4020-222ME_	10	GRM32ER71H106KA12L	DFLS240L	1.15	158	33	2.3
5	-15	1.2	5.6	XAL4020-122ME_	10	GRM32ER71H106KA12L	DFLS240	2.32	118	15	9.1
5	-15	2.4	2.2	XAL4020-222ME_	10	GRM32ER71H106KA12L	DFLS240	2.32	118	2.2	24
5	-30	1.2	5.6	XAL5050-562ME_	10	GRM32ER71H106KA12L	DFLS240	4.12	107	3.3	39
5	-30	2.4	5.6	XAL5050-562ME_	10	GRM32ER71H106KA12L	DFLS240	4.12	107	3.9	36
12	-2.5	1.2	3.3	XAL4030-332ME_	10	GRM32ER71H106KA12L	DFLS240L	0.432	107	470	0.33
12	-2.5	2.4	1.5	XAL4020-152ME_	10	GRM32ER71H106KA12L	DFLS240L	0.432	107	82	0.75
12	-5	1.2	5.6	XAL5050-562ME_	10	GRM32ER71H106KA12L	DFLS240L	1.15	158	180	0.82
12	-5	2.4	2.2	XAL4020-222ME_	10	GRM32ER71H106KA12L	DFLS240L	1.15	158	22	2.2
12	-15	1.2	10	XAL4040-103ME_	10	GRM32ER71H106KA12L	DFLS240	2.32	118	27	4.9
12	-15	2.4	4.7	XAL4030-472ME_	10	GRM32ER71H106KA12L	DFLS240	2.32	118	6.8	10

LAYOUT CONSIDERATIONS

PCB layout is important for all switching regulators but is particularly important for regulators with high switching frequencies. To achieve high efficiency, good regulation, good stability, and low noise, a well designed PCB layout is required. Follow these guidelines when designing PCBs:

- Keep the input bypass capacitor, CIN, close to the PVIN pin and the AVIN pin. Route each of these pins individually to the pad of this capacitor to minimize noise coupling between the power inputs, rather than connecting the two pins at the device. A separate capacitor can be used on the AVIN pin for the best noise performance.
- Keep the high current paths as short as possible. These paths include the connections between CIN, L1, D1, COUT, and GND and their connections to the ADP5074.
- Keep high current traces as short and wide as possible to minimize parasitic series inductance, which causes spiking and EMI.

- Avoid routing high impedance traces near any node connected to the SW pin or near Inductor L1 to prevent radiated switching noise injection.
- Place the feedback resistors as close to the FB pin as possible to prevent high frequency switching noise injection.
- Route a trace to RFT directly from the COUT pad for optimum output voltage sensing.
- Place the compensation components as close as possible to COMP. Do not share vias to the ground plane with the feedback resistors to avoid coupling high frequency noise into the sensitive COMP pin.
- Place the CVREF and CVREG capacitors as close to the VREG and VREF pins as possible. Ensure that short traces are used between VREF and RFB.

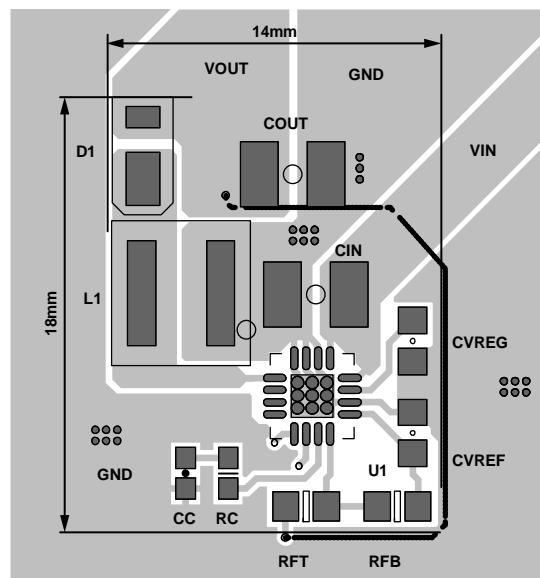

Figure 26. Suggested Layout for 18 mm × 14 mm, +12 V Input to -5 V Output Application
(Dashed Line Is Connected on the Internal Layer of the PCB; Other Vias Connected to the Ground Plane;
SS, EN, PWRGD, SLEW, and SYNC/FREQ Connections Not Shown for Clarity and Are Typically Connected on an Internal Layer)

