

# MAXIM

## MAX8525 Evaluation Kit

Evaluates: MAX8523/MAX8525

### General Description

The MAX8525 evaluation kit (EV kit) demonstrates the high-power, dynamically adjustable multiphase VRM 10.0 application circuit. This DC-DC converter steps down high-voltage input, generating a precision, low-voltage CPU-core V<sub>CC</sub> rail. The MAX8525 EV kit meets the Intel VRM 10 CPU's transient voltage specification and includes logic-to-interface with the CPU power-good signal. The MAX8525 EV kit consists of the MAX8525 current-mode, step-down controller and the MAX8523 high-speed, dual-phase MOSFET gate driver. The MAX8525 EV kit includes rapid-active average current sensing and voltage positioning, thereby reducing power dissipation and bulk output-capacitance requirements. Quad-phase operation reduces input-ripple-current requirements and output voltage ripple.

The MAX8525 EV kit is a fully assembled and tested circuit board that provides a digitally adjustable 0.8375V to 1.5875V output voltage range (6-bit, on-board DAC, 12.5mV increments) from a 12V input source. Each phase delivers up to 25A output current for a total of 100A. The EV kit operates at a 210kHz switching frequency and has superior line- and load-transient responses. Two EV kits can be paralleled for true 8-phase interleaved operation up to 200A. The MAX8525 EV kit can easily be modified to meet Intel's VRM 10.x requirements. Contact the factory for details.

### Features

- ◆ Quad-Phase Current-Mode EV Kit
- ◆ Parallel Operation for 200A Output
- ◆ VRM 10.0 Compatible (Easily Modified for VRM 10.x)
- ◆ Rapid-Active Average Current Sensing
- ◆ Fastest Voltage Positioning
- ◆ High-Speed Accuracy and Efficiency
- ◆ Low Bulk Output-Capacitor Count
- ◆ 12V Input Voltage
- ◆ 0.8375V to 1.5875V Output Voltage Range (6-Bit DAC)
- ◆ 100A Load-Current Capability (25A Each Phase)
- ◆ 210kHz Switching Frequency (Adjustable)
- ◆ Dynamic VID Change
- ◆ Differential Remote Voltage Sensing
- ◆ Power-Good Output
- ◆ 28-Pin QSOP Package (MAX8525)
- ◆ 16-Pin QSOP Package (MAX8523)
- ◆ Fully Assembled and Tested

### Ordering Information

PART	TEMP RANGE	IC PACKAGE
MAX8525EVKIT	0°C to +70°C	16 QSOP (MAX8523) 28 QSOP (MAX8525)

### Component List

DESIGNATION	QTY	DESCRIPTION
C1, C2, C5, C6, C9, C10, C13, C14	8	10μF, 25V X5R ceramic capacitors (1812) Taiyo Yuden TMK432BJ106KM or TDK C4532X5R1E106M
C3, C7, C11, C15	0	Not installed (1812)
C4	0	Not installed (1206)
C8, C12, C32	3	470pF ±10%, 50V X7R ceramic capacitors (0603) Murata GRM188R71H471K or equivalent

DESIGNATION	QTY	DESCRIPTION
C16, C45	2	3300pF ±10%, X7R ceramic capacitors (0402) Murata GRP155R71H332K
C17, C33–C41	10	680μF, 2.5V, 10mΩ low-ESR polymer capacitors (E-case) Sanyo 2R5TPD680M
C18, C42, C43, C44	4	10μF ±20%, 6.3V X5R ceramic capacitors (0805) Taiyo Yuden AMK212BJ106MG or TDK C2012X5R0J106M



# MAX8525 Evaluation Kit

Evaluates: MAX8523/MAX8525

## Component List (continued)

DESIGNATION	QTY	DESCRIPTION
C19, C20	2	2.2 $\mu$ F $\pm$ 10%, 10V X5R ceramic capacitors (0612) TDK C1632X5R1A225K
C21	1	2.2 $\mu$ F $\pm$ 10%, 10V X7R ceramic capacitor (0805) Taiyo Yuden LMK212BJ225KG
C22	1	2.2 $\mu$ F, 35V X7R ceramic capacitor (1206) Taiyo Yuden EMK316BJ225MD
C23, C24, C25	3	1 $\mu$ F, 6.3V X5R ceramic capacitors (0603) Taiyo Yuden JMK107BJ105KA or TDK C1608X5R1A105K
C26–C30	5	0.22 $\mu$ F, 10V X7R ceramic capacitors (0603) Taiyo Yuden LMK107BJ224MA or TDK C1608X7R1C224M
C31	1	820pF $\pm$ 10%, 50V X7R ceramic capacitor (0402) Murata GRP155R71H821
C46–C49	4	0.033 $\mu$ F, 10V X7R ceramic capacitors (0402) Murata GRP155R71A333K
C50	0	Not installed (0402)
C51–C55	0	Not installed (D-case)
D1, D2	2	100mA, 30V dual Schottky diodes (SOT23) Central Semiconductor CMPSH-3A
D3	1	200mA dual silicon diode (SOT23) Central Semiconductor CMPD3003S
D4	1	3.3V Zener diode (SOD-323) Central Semiconductor CMDZ5226B
L1–L4	4	0.6 $\mu$ H, 26A, 0.9m $\Omega$ power inductors (13mm x 13mm x 6mm) Panasonic ETQP1H0R6BFA
N1, N4, N7, N10, N13–N16	8	N-channel MOSFETs (8-pin SO) Fairchild FDS6694 or International Rectifier IRF7821
N2, N3, N5, N6, N8, N9, N11, N12	8	N-channel MOSFETs (8-pin SO) Fairchild FDS6688 or International Rectifier IRF7832

DESIGNATION	QTY	DESCRIPTION
R1–R4	4	0.001 $\Omega$ $\pm$ 1%, 1W resistors (2512) Panasonic ERJM1WTF1M0U
R5	1	309 $\Omega$ $\pm$ 1% resistor (0603)
R6	1	1.3k $\Omega$ $\pm$ 1% resistor (0603)
R7, R30, R34, R39, R40	5	0 $\Omega$ $\pm$ 1% resistors (0603)
R8–R11	4	3.3 $\Omega$ $\pm$ 5% resistors (0603)
R12, R14	2	10 $\Omega$ $\pm$ 5% resistors (0603)
R13	1	10 $\Omega$ $\pm$ 5% resistor (0402)
R15, R17	2	15k $\Omega$ $\pm$ 5% resistors (0603)
R16	1	100k $\Omega$ $\pm$ 5% resistor (0603)
R18	0	Not installed (0603)
R19, R20	2	50 $\Omega$ $\pm$ 5% resistors (0603)
R21, R26	2	10k $\Omega$ $\pm$ 1% resistors (0402)
R22	1	2.67k $\Omega$ $\pm$ 1% resistor (0402)
R23	1	332k $\Omega$ $\pm$ 1% resistor (0603)
R24, R25	2	100 $\Omega$ $\pm$ 5% resistors (0603)
R27, R33	2	27.4k $\Omega$ $\pm$ 1% resistors (0402)
R28, R29	2	1k $\Omega$ $\pm$ 5% resistors (0603)
R31	1	1.05k $\Omega$ $\pm$ 1% resistor (0402)
R32	1	1.91k $\Omega$ $\pm$ 1% resistor (0402)
R35–R38	4	24 $\Omega$ $\pm$ 5% resistors (0402)
R41–R47	7	1k $\Omega$ $\pm$ 5% resistors (0402)
R48, R49	2	0 $\Omega$ $\pm$ 1% resistors (0402)
U1	1	MAX8525EEI (28-pin QSOP)
U2, U3	2	MAX8523EEE (16-pin QSOP)
U4	1	Adjustable linear regulator (DPAK) Fairchild KA317MR or National Semiconductor LM317MDT
None	1	Heatsink with mounting hardware Thermshield TS-54960-CW
None	1	Heatsink insulation Bergquist GP-54960
None	2	Heatsink mounting hardware 4–40 screws
None	1	MAX8525 PC board

# MAX8525 Evaluation Kit

## Component Suppliers

SUPPLIER	PHONE	FAX	WEBSITE
Bergquist	952-835-2322	952-835-4156	www.bergquistcompany.com
Central Semiconductor	516-435-1110	516-435-1824	www.centralsemi.com
Fairchild	408-721-2181	408-721-1635	www.fairchildsemi.com
International Rectifier	310-322-3331	310-322-3332	www.irf.com
Murata	770-436-1300	770-436-3030	www.murata.com
Panasonic	714-373-7939	714-373-7183	www.panasonic.com
Sanyo	619-661-6835	619-661-1055	www.sanyovideo.com
Taiyo Yuden	408-573-4150	408-573-4159	www.t-yuden.com
TDK	847-390-4373	847-390-4428	www.component.tdk.com
Thermshield	603-524-3714	603-524-6602	www.thermshield.com

**Note:** Please indicate that you are using the MAX8523 and MAX8525 when contacting these component suppliers.

## Detailed Description

This 100A, quad-phase, buck-regulator design is optimized for a 210kHz frequency and output-voltage settings near 1.20V. The output voltage can be digitally set from 0.8375V to 1.5875V from the VID0–VID5 pins (Table 1). At  $V_{OUT} = 1.20V$  and  $V_{IN} = 12V$ , the inductor ripple is approximately 35% ( $LIR = 0.35$ ). The switching frequency is set by an external resistor R23 (332k $\Omega$ ) from OSC to ground. The MAX8525 includes a 6-bit DAC and meets Intel's VRM 10.0 specifications. The kit features controlled VID voltage transition for dynamic VID changes and eliminates both undervoltage and overvoltage overshoot. The PWRGD signal is blanked during VID code changes to avoid any false fault signal due to the output voltage change requested by the CPU. Peak current-mode control provides the fastest transient response. The proprietary current-sharing scheme reduces current imbalance between phases to <5% at full load. The MAX8525 EV kit also includes programmable no-load offset and output voltage positioning to adjust the output voltage as a function of the output current.

The MAX8525 provides cycle-by-cycle current limit to control the average output current. The EV kit also offers current-foldback protection under short-circuit and overload conditions. This feature allows the VRM to safely operate under a short-circuit condition and to automatically recover once the short-circuit condition is removed. Once the output voltage falls below the low-PWRGD threshold, the foldback-current threshold is set to half of the current-limit threshold. The foldback protection is active when the output voltage is below the PWRGD threshold or the output current is greater than the current-limit threshold.

**Table 1. VID-Programmed Output Voltage (VRM 10.0)**

VID5	VID4	VID3	VID2	VID1	VID0	VOUT
0	0	1	0	1	0	0.8375
1	0	1	0	0	1	0.8500
0	0	1	0	0	1	0.8625
1	0	1	0	0	0	0.8750
0	0	1	0	0	0	0.8875
1	0	0	1	1	1	0.9000
0	0	0	1	1	1	0.9125
1	0	0	1	1	0	0.9250
0	0	0	1	1	0	0.9375
1	0	0	1	0	1	0.9500
0	0	0	1	0	1	0.9625
1	0	0	1	0	0	0.9750
0	0	0	1	0	0	0.9875
1	0	0	0	1	1	1.0000
0	0	0	0	1	1	1.0125
1	0	0	0	1	0	1.0250
0	0	0	0	1	0	1.0375
1	0	0	0	0	1	1.0500
0	0	0	0	0	1	1.0675
1	0	0	0	0	0	1.0750
0	0	0	0	0	0	1.0875
1	1	1	1	1	1	OFF
0	1	1	1	1	1	OFF
1	1	1	1	1	0	1.1000
0	1	1	1	1	0	1.1125

Evaluates: MAX8523/MAX8525

# MAX8525 Evaluation Kit

**Evaluates: MAX8523/MAX8525**

**Table 1. VID-Programmed Output Voltage (VRM 10.0) (continued)**

VID5	VID4	VID3	VID2	VID1	VID0	VOUT
1	1	1	1	0	1	1.1250
0	1	1	1	0	1	1.1375
1	1	1	1	0	0	1.1500
0	1	1	1	0	0	1.1625
1	1	1	0	1	1	1.1750
0	1	1	0	1	1	1.1875
1	1	1	0	1	0	1.2000
0	1	1	0	1	0	1.2125
1	1	1	0	0	1	1.2250
0	1	1	0	0	1	1.2375
1	1	1	0	0	0	1.2500
0	1	1	0	0	0	1.2625
1	1	0	1	1	1	1.2750
0	1	0	1	1	1	1.2875
1	1	0	1	1	0	1.3000
0	1	0	1	1	0	1.3125
1	1	0	1	0	1	1.3250
0	1	0	1	0	1	1.3375
1	1	0	1	0	0	1.3500
0	1	0	1	0	0	1.3625

VID5	VID4	VID3	VID2	VID1	VID0	VOUT
1	1	0	0	1	1	1.3750
0	1	0	0	1	1	1.3875
1	1	0	0	1	0	1.4000
0	1	0	0	1	0	1.4125
1	1	0	0	0	1	1.4250
0	1	0	0	0	1	1.4375
1	1	0	0	0	0	1.4500
0	1	0	0	0	0	1.4625
1	0	1	1	1	1	1.4750
0	0	1	1	1	1	1.4875
1	0	1	1	1	0	1.5000
0	0	1	1	1	0	1.5125
1	0	1	1	0	1	1.5250
0	0	1	1	0	1	1.5375
1	0	1	1	0	0	1.5500
0	0	1	1	0	0	1.5625
1	0	1	0	1	1	1.5750
0	0	1	0	1	1	1.5875
1	0	1	0	1	0	1.5875

# MAX8525 Evaluation Kit

Evaluates: MAX8523/MAX8525

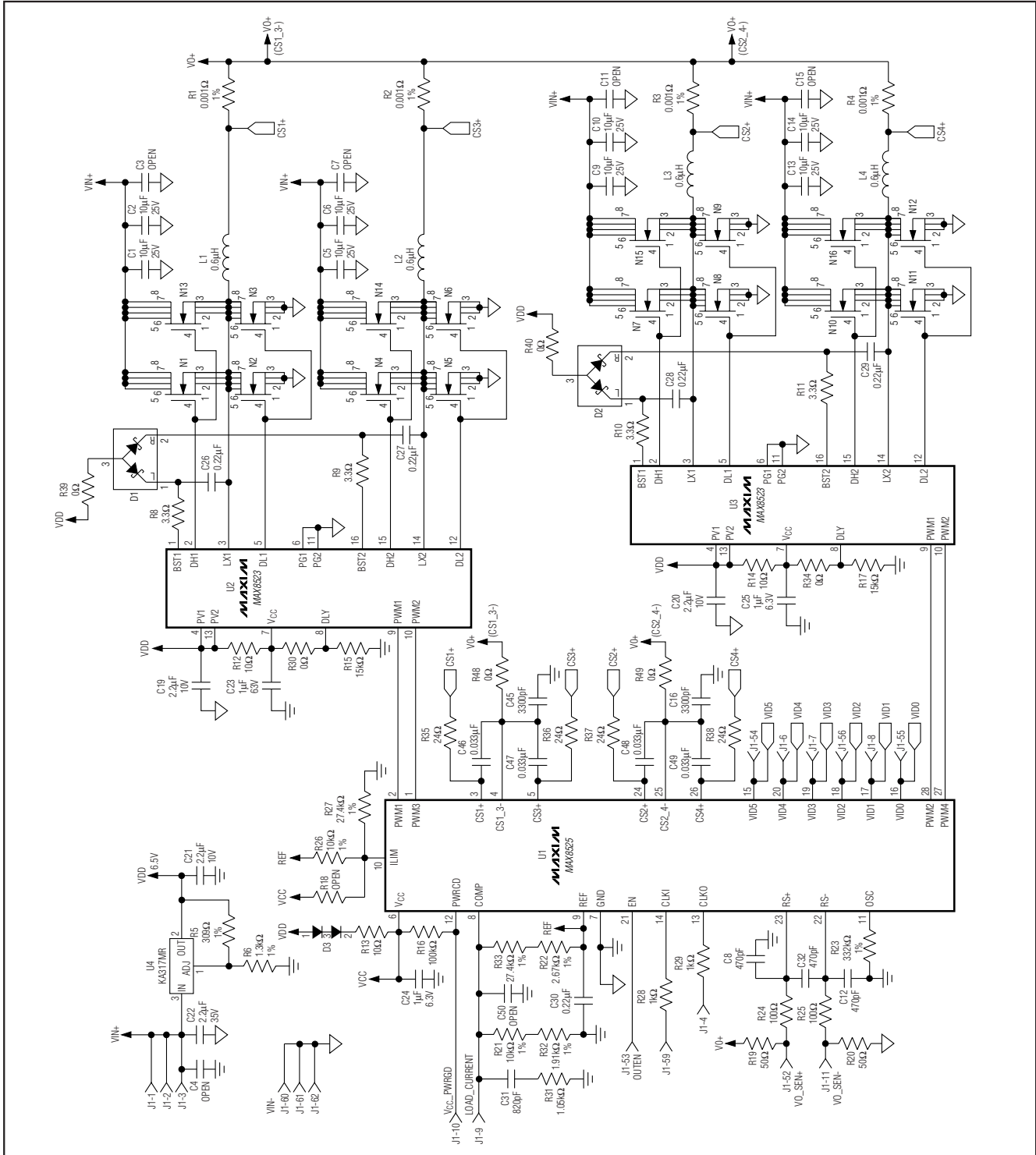

Figure 1. MAX8525 EV Kit Schematic (Sheet 1 of 2)

# MAX8525 Evaluation Kit

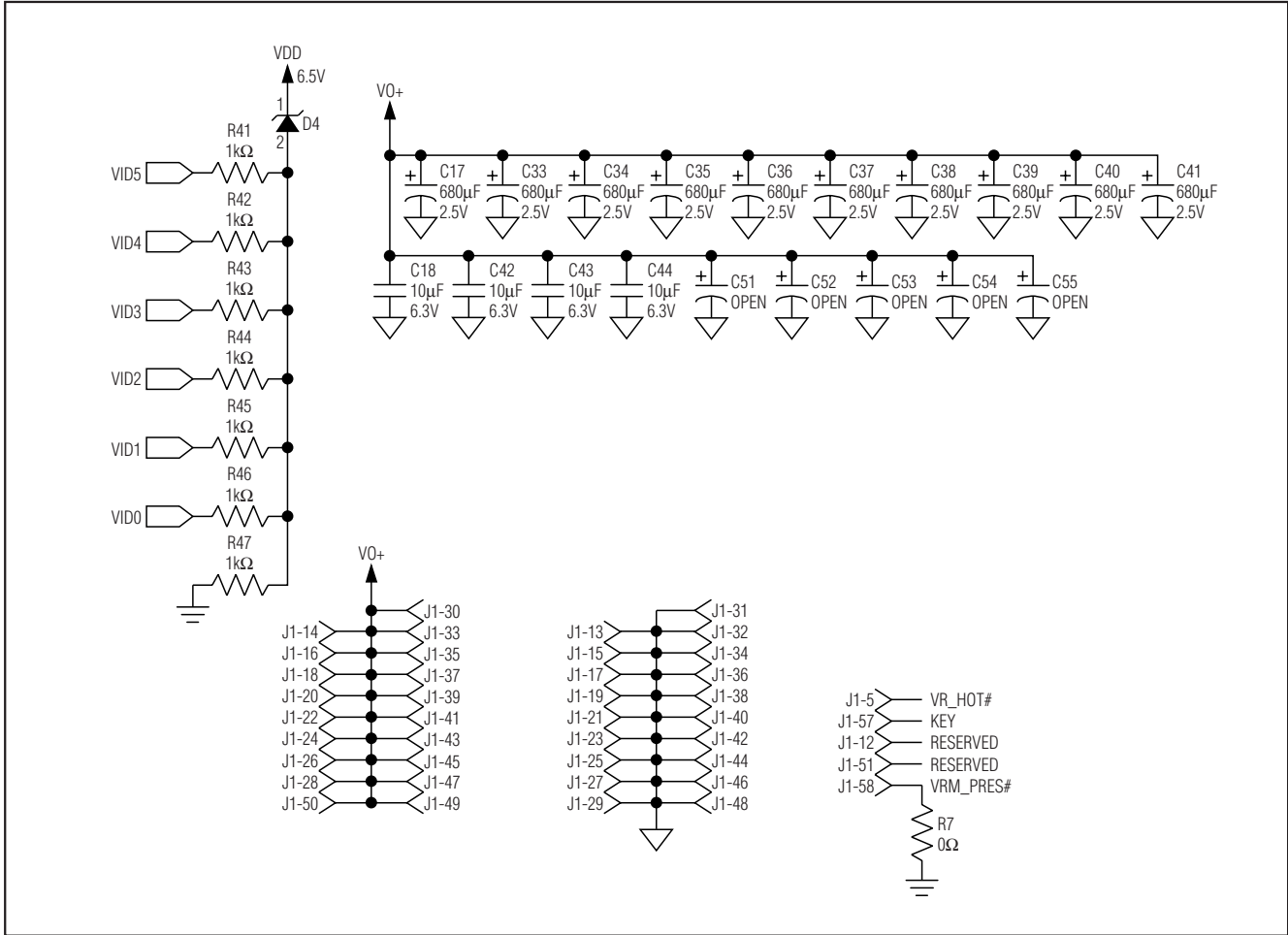

Figure 2. MAX8525 EV Kit Schematic (Sheet 2 of 2)

# MAX8525 Evaluation Kit

Evaluates: MAX8523/MAX8525

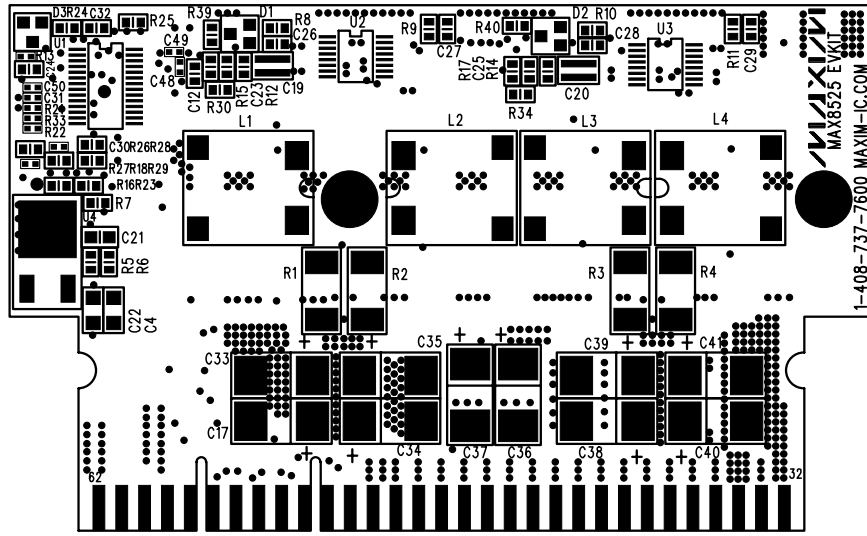

Figure 3. MAX8525 EV Kit Component Placement Guide—Component Side

# MAX8525 Evaluation Kit

**Evaluates: MAX8523/MAX8525**

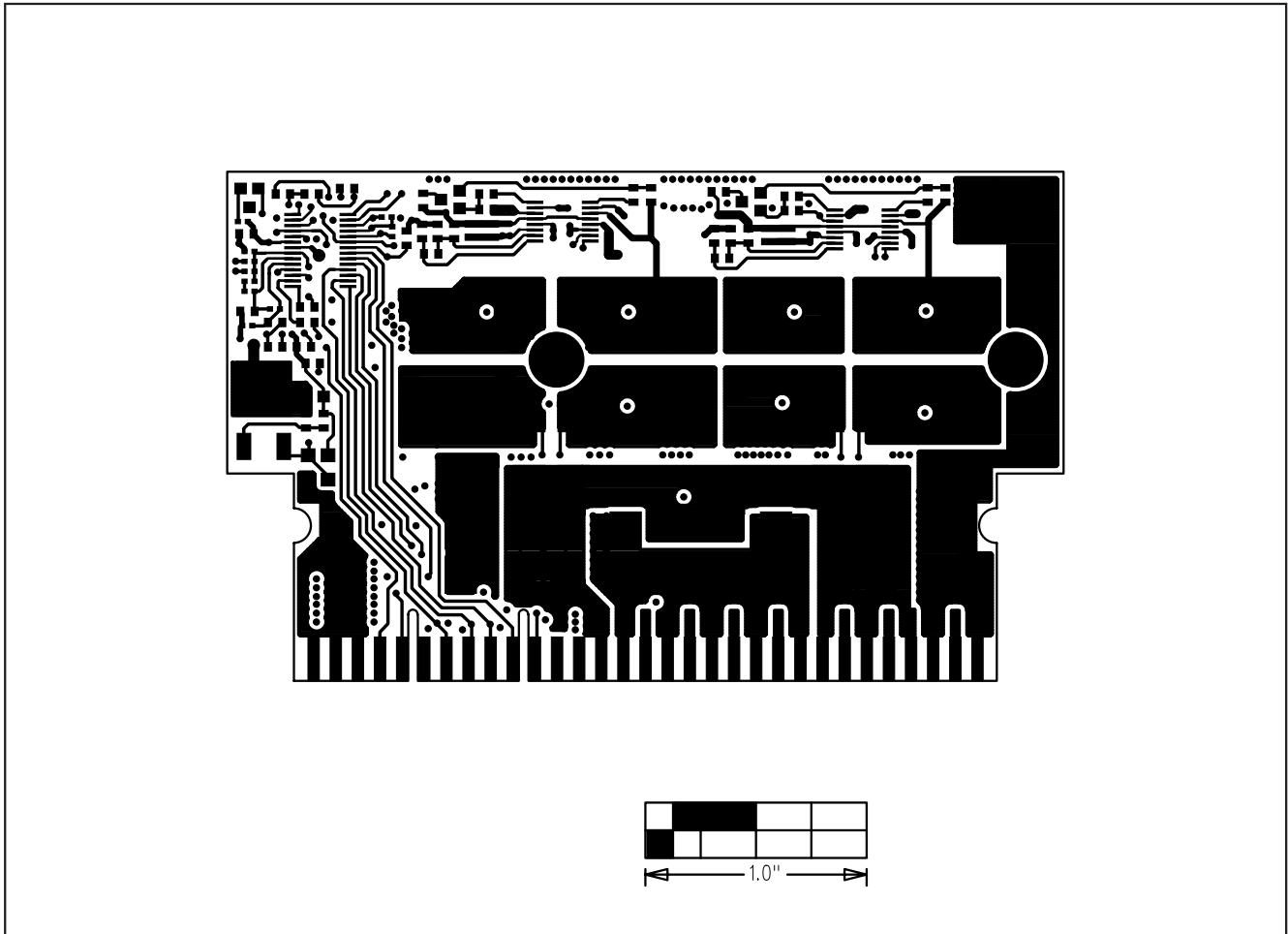

Figure 4. MAX8525 EV Kit PC Board Layout—Component Side



# MAX8525 Evaluation Kit

Evaluates: MAX8523/MAX8525

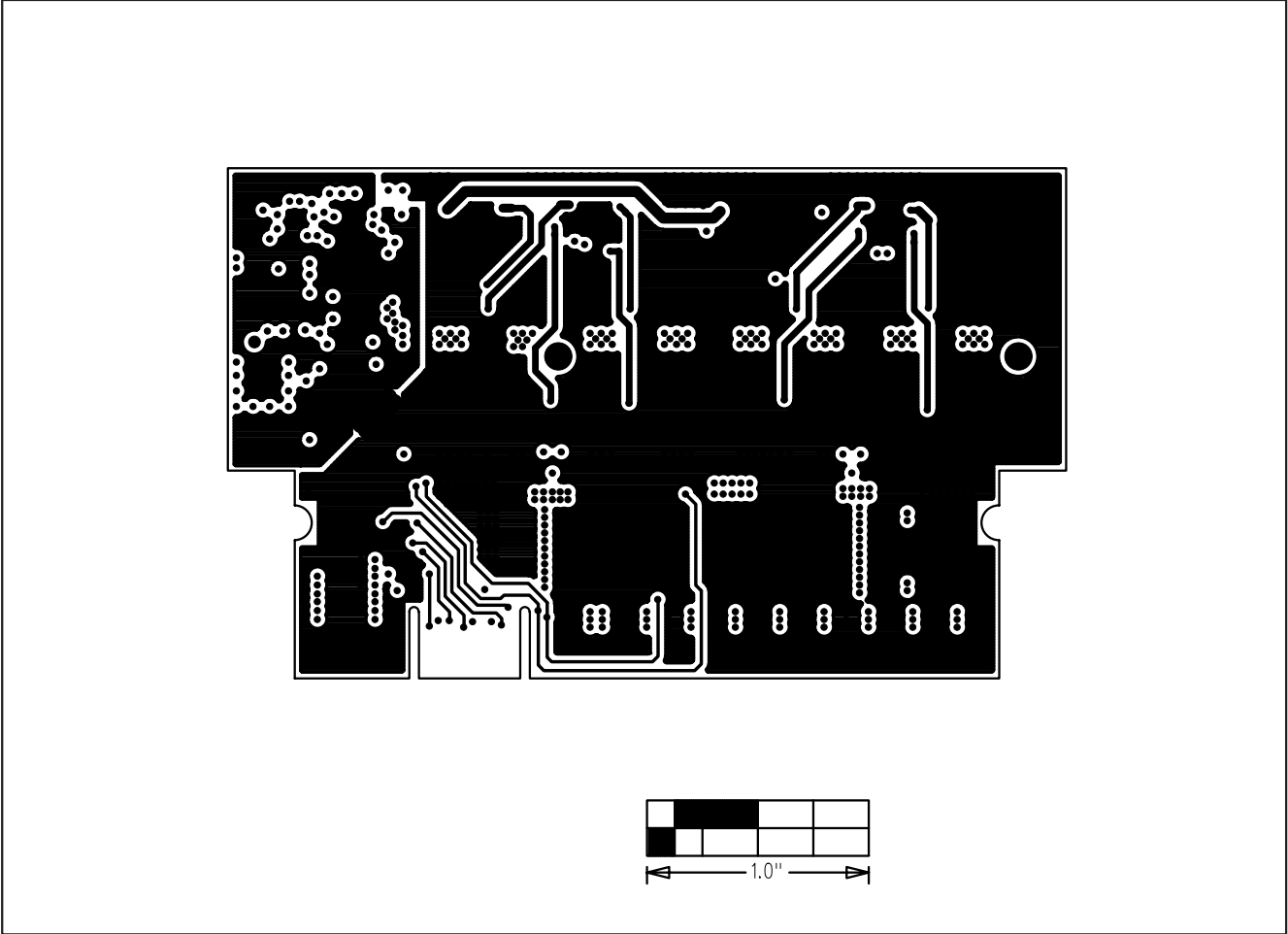

Figure 5. MAX8525 EV Kit PC Board Layout—GND Layer 2

# MAX8525 Evaluation Kit

Evaluates: MAX8523/MAX8525

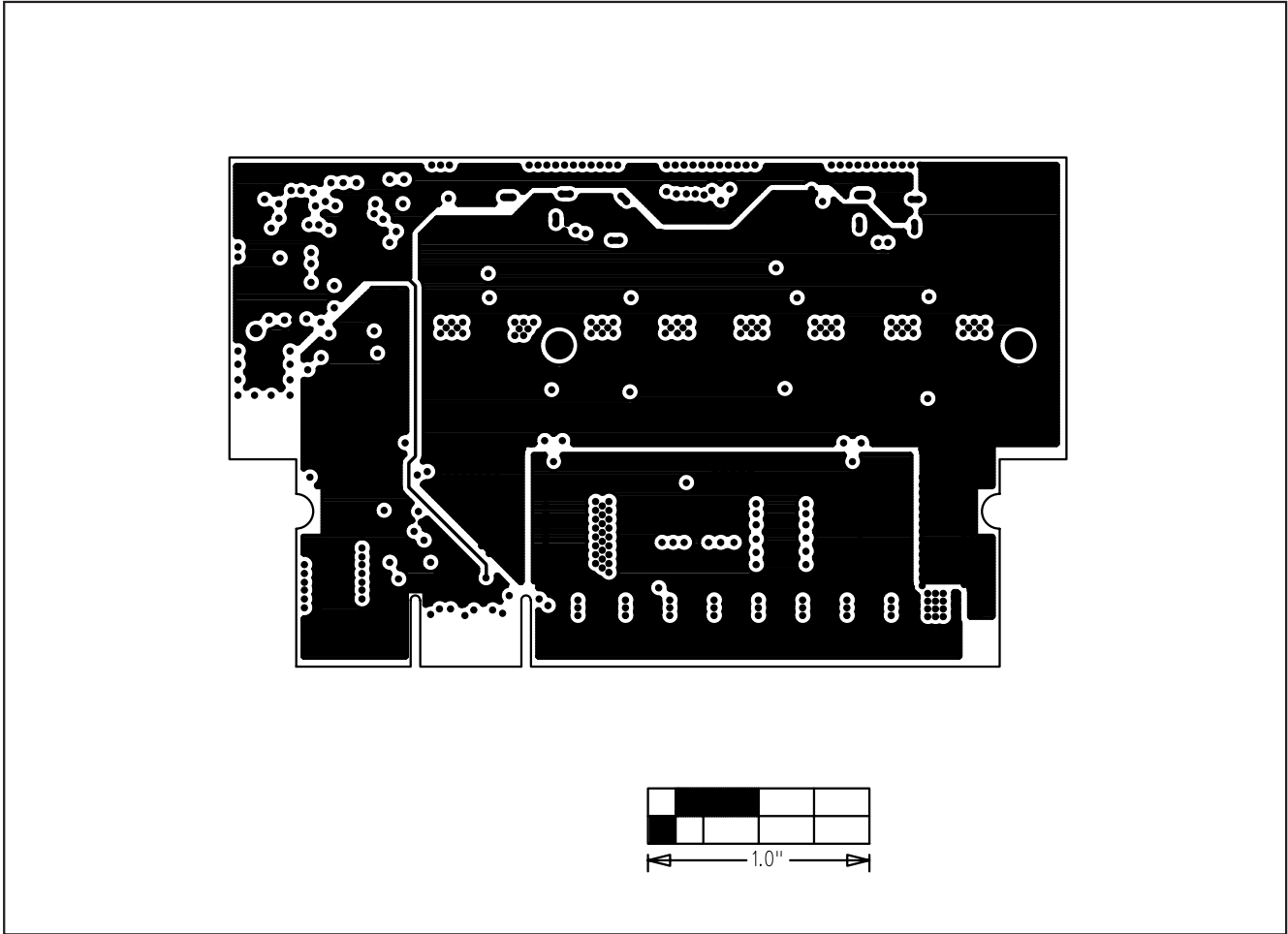

Figure 6. MAX8525 EV Kit PC Board Layout—GND Layer 3

# MAX8525 Evaluation Kit

Evaluates: MAX8523/MAX8525

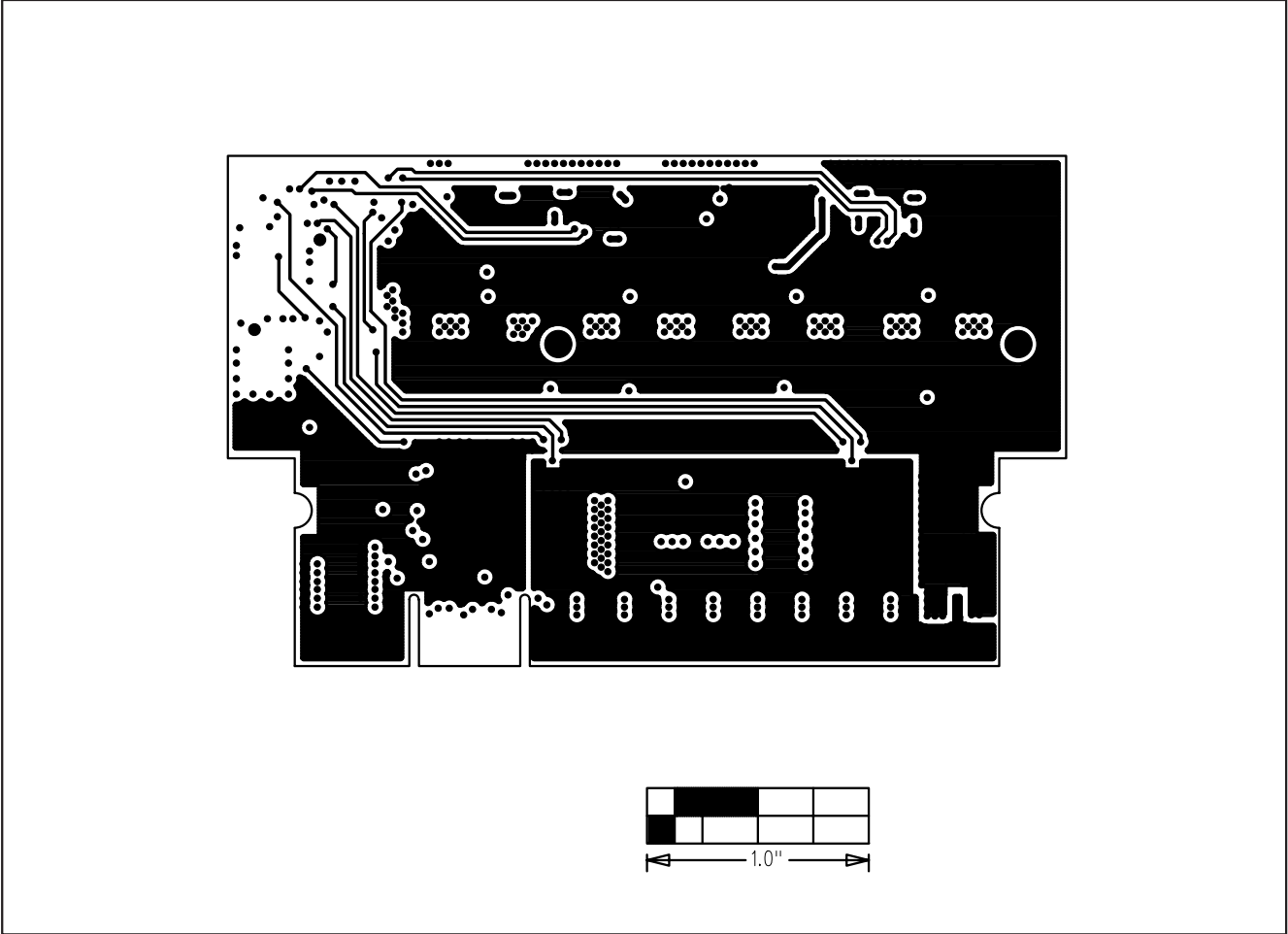

Figure 7. MAX8525 EV Kit PC Board Layout—SENSE/GND Layer 4

# MAX8525 Evaluation Kit

Evaluates: MAX8523/MAX8525

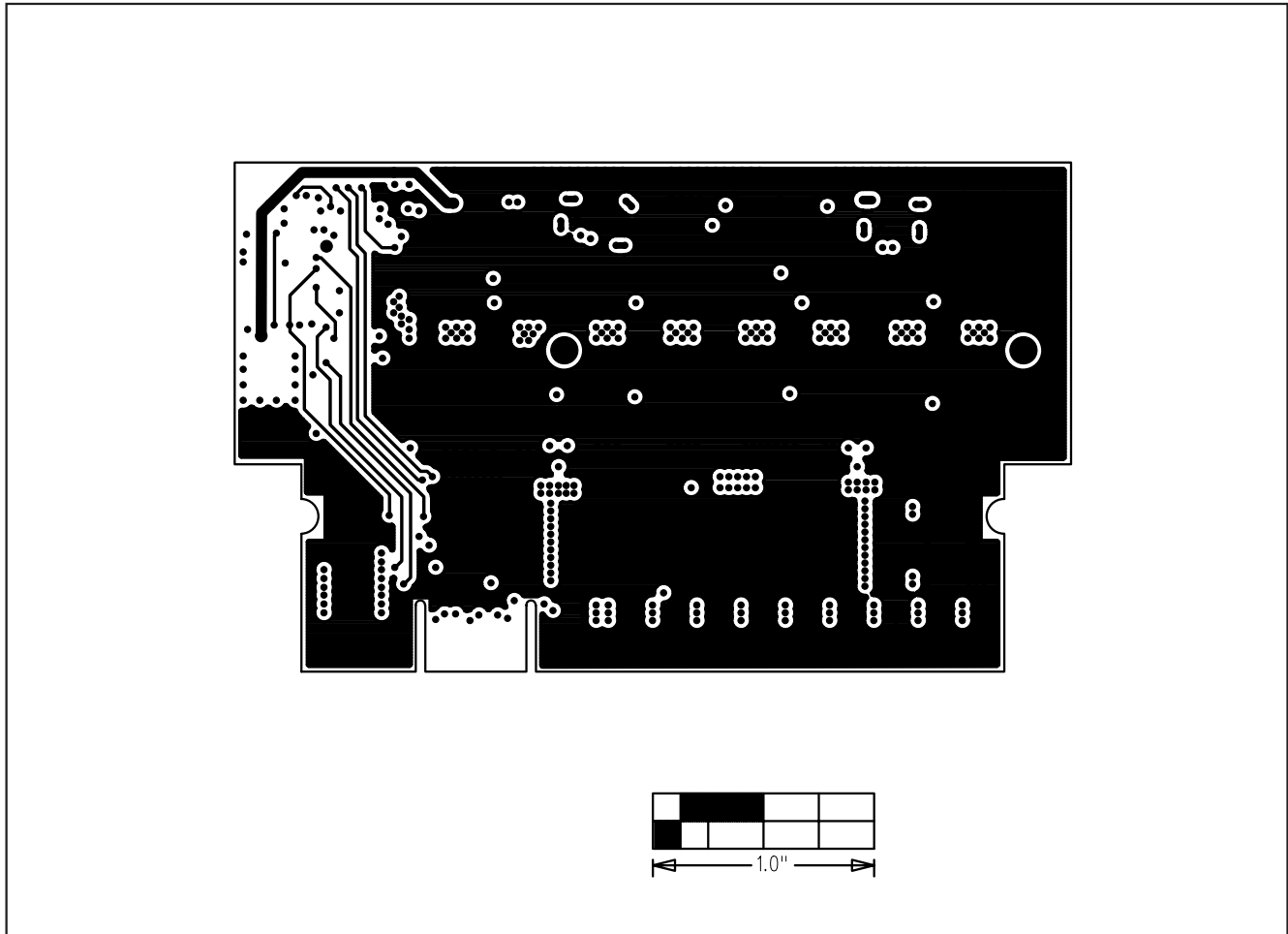

Figure 8. MAX8525 EV Kit PC Board Layout—GND Layer 5

# MAX8525 Evaluation Kit

Evaluates: MAX8523/MAX8525

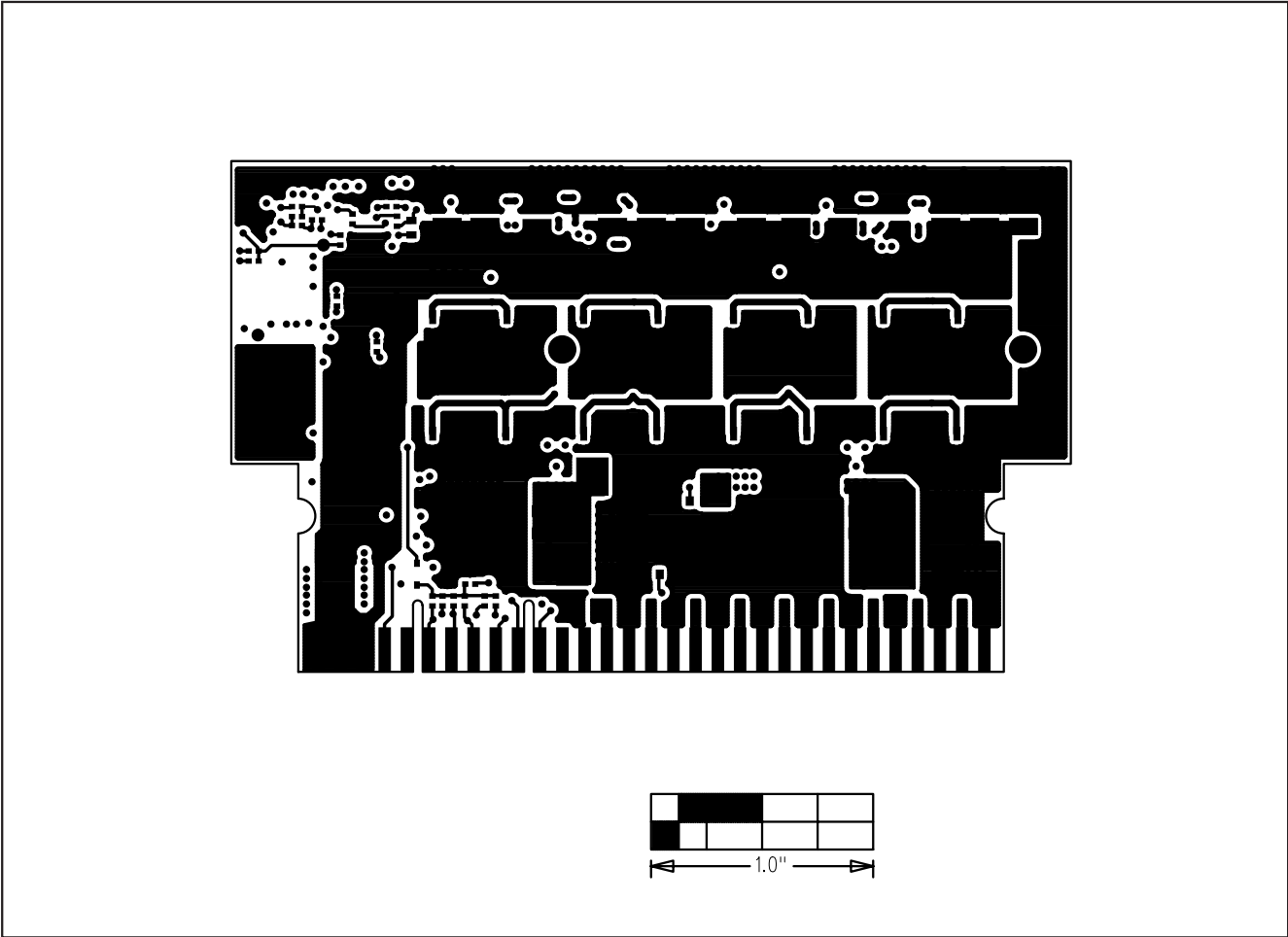

Figure 9. MAX8525 EV Kit PC Board Layout—Solder Side

# MAX8525 Evaluation Kit

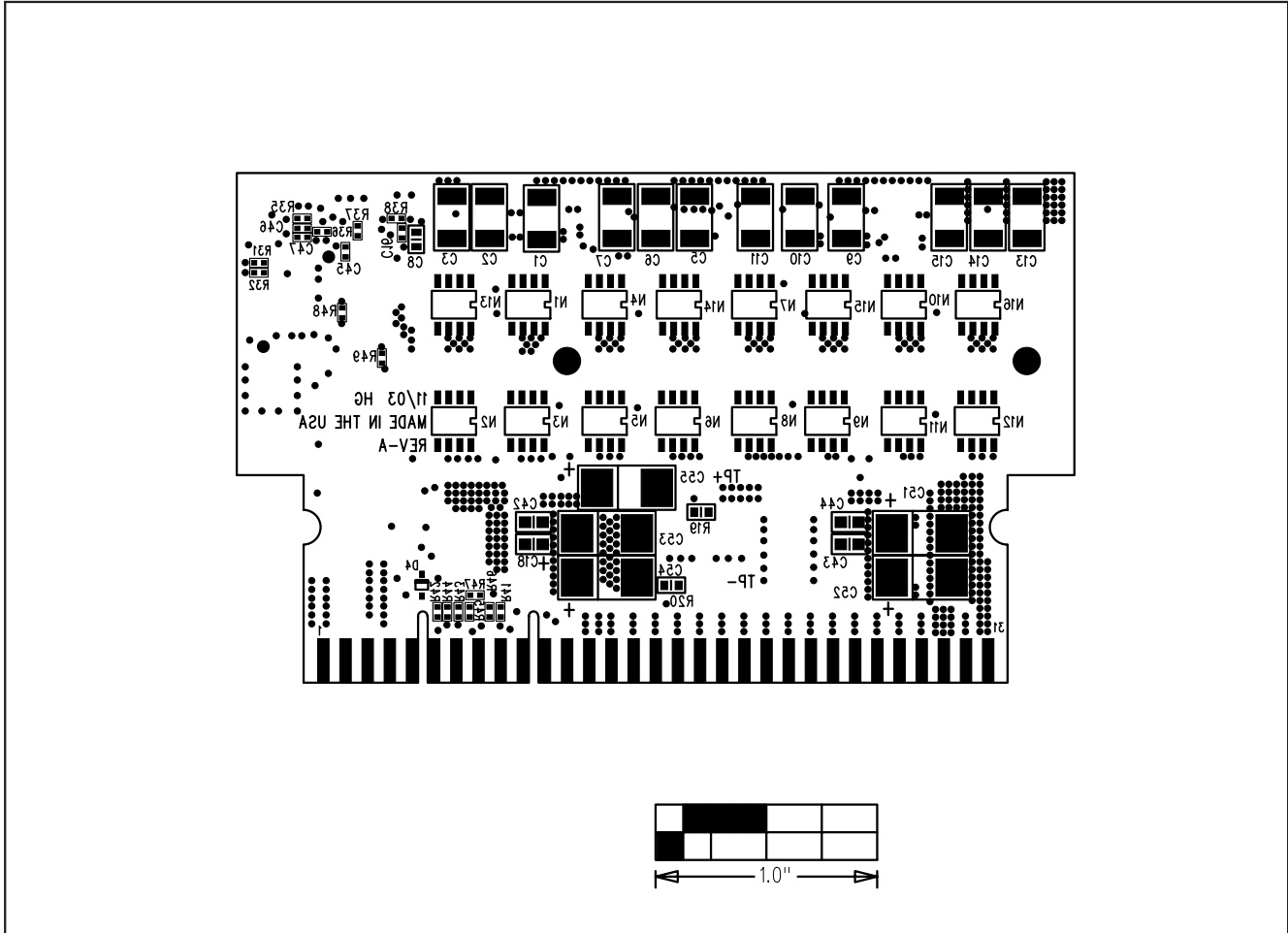

Figure 10. MAX8525 EV Kit Component Placement Guide—Solder Side

Maxim cannot assume responsibility for use of any circuitry other than circuitry entirely embodied in a Maxim product. No circuit patent licenses are implied. Maxim reserves the right to change the circuitry and specifications without notice at any time.