

E2C/E2C-H

Separate Amplifier Sensor with Sensitivity Adjustment

- Compact design with smaller Sensor Head.
- Heat-resistance model available for application between -10 and 200°C.



 Be sure to read *Safety Precautions* on page 15.

Ordering Information

Sensors

Standard Models

Sensor				Combination	Amplifier Units			
Appearance	Stable sensing area *1	Model	Model		Power supply/ Output	Timer function	Self-diagnostic output	
Unshielded *2	2 dia.	0.5 (1.2) mm	E2C-CR5B		E2C-GE4B	DC/ (NPN)	---	---
	Shielded	3.5 dia.	0.8 (1.8) mm		E2C-CR8A	E2C-GF4B	DC/ (PNP)	---
3.8 dia.		0.8 (1.8) mm	E2C-CR8B		E2C-GE4A	DC/ (NPN)	---	---
M5		1 (2) mm	E2C-X1A		E2C-GF4A	DC/ (PNP)	---	---
5.4 dia.		1 (2) mm	E2C-C1A		E2C-WH4A	DC/(NPN/ PNP)	---	---
M8		1.5 (3) mm	E2C-X1R5A		E2C-JC4AP *	DC/ (NPN)	Yes	Yes
M12		2 (5) mm	E2C-X2A		E2C-JC4A	DC/ (NPN)	Yes	---
M18		5 (10) mm	E2C-X5A		E2C-AM4A	DC/(NPN/ PNP)	---	---
M30	10 (18) mm	E2C-X10A	E2C-AK4A		AC	---	---	
Unshielded	40 dia.	20 (50) mm	E2C-C20MA					

*1. Values in parentheses are for the maximum sensing distances at 23°C.
 *2. Although the E2C-CR5B has a shielded structure, it cannot be embedded in metal.

* Self-diagnostic output, timer, and DIN Track mounting.

Heat-resistant Model

Sensor			Combination	Amplifier Unit
Appearance	Stable sensing area	Model		Model
Shielded	M8	1.5 mm		E2C-JC4CH
	M12	2 mm		E2C-JC4DH
	M18	5 mm		E2C-JC4EH

Note: Characteristics will change if the cable length changes. Do not cut or extend the cable.

Accessories (Order Separately)**Mounting Brackets**

Name	Model	Applicable Sensors	Remarks
Mounting Brackets	Y92E-F3R5	E2C-CR8A, for 3.5 dia.	---
	Y92E-F5R4	E2C-C1A, for 5.4 dia.	

Connection Sockets

Name	Model	Applicable Amplifier Unit	Remarks	
Front Connection Sockets	PYF08A	E2C-GE4A E2C-GE4B E2C-GF4A E2C-GF4B	Hold-down Clips (Order Separately) PYC-A1 Sold as a set.	
		P2CF-08		E2C-AM4A
		P2CF-11		E2C-AK4A
Back Connection Sockets	P3G-08	E2C-AM4A	---	
	P3GA-11	E2C-AK4A		

Adapters

Name	Model	Applicable Amplifier Unit	Remarks
Embedded Adapters	Y92F-30	E2C-AM4A/-AK4A	---
	Y92F-70		
	Y92F-71		

For details on *Mounting Brackets*, *Protective Covers*, and *Sputter Protective Covers*, refer to Y92□.

Ratings and Specifications

Standard Models

Sensors

Model		E2C-CR5B	E2C-CR8A/ -CR8B	E2C-X1A/ -C1A	E2C-X1R5A	E2C-X2A	E2C-X5A	E2C-X10A	E2C-C20MA
Sensing distance (at 23°C)		1.2 mm	1.8 mm	2 mm	3 mm	5 mm	10 mm	18 mm	50 mm
Stable sensing area	Ambient temperature	0 to 0.5 mm	0 to 0.8 mm	0 to 1 mm	0 to 1.5 mm	0 to 2 mm	0 to 5 mm	0 to 10 mm	0 to 20 mm
	At 0 to 40°C	0 to 0.7 mm	0 to 1.2 mm	0 to 1.5 mm	0 to 2 mm	0 to 2.5 mm	0 to 7 mm	0 to 15 mm	0 to 28 mm
Differential travel		Refer to <i>Ratings and Specifications</i> on page 4 for Amplifier Unit specifications.							
Detectable object		Ferrous metal (The sensing distance decreases with non-ferrous metal. Refer to <i>Engineering Data</i> on page 7.)							
Standard sensing object		Iron, 5 × 5 × 1 mm			Iron, 8 × 8 × 1 mm	Iron, 12 × 12 × 1 mm	Iron, 18 × 18 × 1 mm	Iron, 30 × 30 × 1 mm	Iron, 50 × 50 × 1 mm
Response frequency *1		1 kHz			800 Hz		350 Hz	100 Hz	50 Hz
Ambient temperature range		Operating: -10 to 55°C	Operating/Storage: -25 to 70°C (with no icing or condensation)						
Ambient humidity range		Operating/Storage: 35% to 95% (with no condensation)							
Temperature influence		±25% max. of sensing distance at 23°C in the temperature range of -10 to 55°C	15% max. of sensing distance at 23°C in the temperature range of -25 to 70°C						
Vibration resistance		Destruction: 10 to 55 Hz, 1.5-mm double amplitude for 2 hours each in X and Y directions							
Shock resistance		Destruction: 500 m/s ² 3 times each in X and Y directions							
Degree of protection		IEC 60529 IP64	IEC 60529 IP67, in-house standards: oil-resistant						
Connection method *2		Pre-wired Models							
		Shielded cable (Cable length: 3 m)	High-frequency coaxial cable (Standard cable length: 3 m)						
Weight (packed state)		Approx. 10 g	Approx. 40 g	Approx. 45 g	Approx. 50 g	Approx. 60 g	Approx. 140 g	Approx. 270 g	Approx. 300 g
Materials	Case	Stainless steel		Brass					
	Sensing surface	ABS resin							
	Cable	Polyethylene							
	Clamping nut	---		Brass, nickel-plated (except E2C-C1A)					
	Toothed washer	---		Brass, zinc-plated (except E2C-C1A)					
Accessories		---							

*1. The minimum value when using the solid-state control output on the Amplifier Unit.

Measurement conditions are as follows: standard sensing object, a distance of twice the standard sensing object, and a set distance of half the sensing distance.

*2. Refer to 6 for cable lengths when combining Amplifier Units and Sensors.

The characteristic impedance of the high-frequency coaxial cable is 50 Ω.

Amplifier Units

Item	Model	E2C-GE4□	E2C-GF4□	E2C-JC4A E2C-JC4AP	E2C-WH4A	E2C-AM4A	E2C-AK4A
Power supply voltage (operating voltage range)		12 to 24 VDC (10 to 30 VDC), ripple (p-p): 10% max. *1					100 to 240 VAC (90 to 264 VAC) 50/60 Hz
Current consumption		25 mA max.		45 mA max.	25 mA max.	50 mA max.	55 mA max.
Sensing distance adjustment range *2		20% min. of rated sensing distance with 4-turn potentiometer		20% to 100% of rated sensing distance with 4-turn potentiometer			
Differential travel adjustment range		Differential travel fixed (10% max. of sensing distance)				1% to 5% of rated sensing distance *3	
Re-sponse time	Solid-state	(Refer to the response frequency of the Proximity Sensor.)					
	Relay	---					
Control outputs	Solid-state	NPN Load resistance: 4.7 kΩ, 100 mA max. (40 VDC max.) (Residual voltage: 1.5 V max.)	PNP Load resistance: 4.7 kΩ, 100 mA max. (40 VDC max.) (Residual voltage: 1.5 V max.)	NPN Open-collector output 100 mA max. (40 VDC max.) (Residual voltage: 0.7 V max.) (E2C-JC4AP: 1 V max.)	NPN/PNP output Open-collector output 200 mA max. (40 VDC max.) (Residual voltage: 1.5 V max.)		Transistor/photocoupler 50 mA max. (40 VDC max.) (Residual voltage: 2 V max.)
	Relay	---					
Indicators		Detection indicator (red) (OPERATION)		Detection indicator (red) (OPERATION) Stability indicator (green) (STABILITY)	Detection indicator (red) (OPERATION)	Detection indicator (red) (OPERATION) Stability indicator (green) (STABILITY)	
Operation mode		Changed with NO/NC switch.					
Self-diagnostic output		---		(E2C-JC4AP only) Output transistor turns ON when Sensor open circuit or unstable sensing is detected; solid-state NPN open-collector 50 mA max. (40 VDC max.) (Residual voltage: 1 V max.)	---		
Timer function		---		OFF-delay: 40 ±10 ms	---		
Cable length compensation between Sensor and Amplifier Unit		---		(E2C-JC4AP only) 3 m/5 m, terminals Short-plate switching Shorted: 1 to 3 m Open: 3 to 5 m	Switched between 3 and 5 m.	Mode switched with 4-position switch.	
Ambient temperature range		Operating/storage: -10 to 55°C (with no icing or condensation)					
Ambient humidity range		Operating/Storage: 35% to 85% (E2C-JC4AP: 35% to 95%) (with no condensation)					
Temperature influence		10% max. of sensing distance at 23°C in the temperature range of -10 to 55°C					
Voltage influence		DC Models: ±1% max. of sensing distance at rated voltage in the rated voltage ±20% range AC Models: ±1% max. of sensing distance at rated voltage in the rated voltage ±10% range					
Insulation resistance		50 MΩ min. (at 500 VDC) between current-carrying parts and case					
Dielectric strength		DC Models: 1,000 VAC, 50/60 Hz for 1 min between current-carrying parts and case AC Models: 1,500 VAC, 50/60 Hz for 1 min between current-carrying parts and case					
Vibration resistance		Destruction: 10 to 25 Hz, 2-mm double amplitude for 2 hours each in X, Y, and Z directions		Destruction: 10 to 55 Hz, 1.5-mm double amplitude for 2 hours each in X, Y, and Z directions	Destruction: 10 to 25 Hz, 2-mm double amplitude for 2 hours each in X, Y, and Z directions		

Item	Model	E2C-GE4□	E2C-GF4□	E2C-JC4A E2C-JC4AP	E2C-WH4A	E2C-AM4A	E2C-AK4A
Shock resistance	Destruction: 100 m/s ² 3 times each in X, Y, and Z directions						
Life expectancy	---						Mechanical: 10,000,000 operations min. Electrical: 100,000 operations min.
Connection method	Terminal block			Pre-wired Models (Standard cable length: 2 m)	Terminal block		
Weight (packed state) *5	Approx. 20 g			E2C-JC4A: Approx. 50 g E2C-JC4AP: Approx. 80 g	Approx. 80 g	Approx. 140 g	Approx. 250 g
Accessories	Instruction manual			Caution labels, Mounting Bracket, instruction manual	Instruction manual		

*1. A full-wave rectification power supply of 24 VDC ±10% (average value) can be used (except for the E2C-GE4□).

*2. The sensing distance range required to maintain performed is given for using the Amplifier Unit in combination with the Sensor.

*3. E2C-CR5B: 1% to 20% of rated sensing distance.

*4. Internal relay: G2R-14 DC 12V

*5. The weight of the Connection Socket is not included.

Heat-resistant Models

Sensors

Item	Model	E2C-X1R5AH	E2C-X2AH	E2C-X5AH
Detectable object	Ferrous metal (The sensing distance decreases with non-ferrous metal, refer to <i>Engineering Data</i> on page 7.)			
Standard sensing object	Iron, 8 × 8 × 1 mm	Iron, 12 × 12 × 1 mm	Iron, 18 × 18 × 1 mm	
Stable sensing area	0 to 1.5 mm	0 to 2 mm	0 to 5 mm	
Differential travel	0.04 mm max.		0.1 mm max.	
Response frequency *1	300 Hz			
Ambient temperature range	Operating/Storage: -10 to 200°C (with no icing or condensation)			
Ambient humidity range	Operating/Storage: 35% to 95% (with no condensation)			
Temperature influence	±0.2%/°C			
Vibration resistance	Destruction: 10 to 55 Hz, 1.5-mm double amplitude for 2 hours each in X, Y, and Z directions			
Shock resistance	Destruction: 500 m/s ² 3 times each in X, Y, and Z directions			
Degree of protection	IEC 60529 IP60 *2			
Connection method	Pre-wired Models (Cable length: 3 m) Heat-resistant, high-frequency coaxial cable			
Weight (packed state)	Approx. 50 g	Approx. 60 g	Approx. 140 g	
Materials	Case	Brass		
	Sensing surface	PEEK (polyether ether ketone)		
	Cable	Fluorine resin		
	Clamping nut	Brass, nickel-plated		
	Toothed washer	Iron, zinc-plated		

Note: Ratings and characteristic are given for 50% of the stable sensing area.

*1. Measurement conditions are as follows: standard sensing object, a distance of twice the standard sensing object, and a set distance of half the sensing distance.

*2. Do not operate the Sensor in areas exposed to water vapor because the enclosure is not waterproof.

Amplifier Units

Item	Model	E2C-JC4CH	E2C-JC4DH	E2C-JC4EH
Power supply voltage *1 (operating voltage range)	12 to 24 VDC (10 to 30 VDC), ripple (p-p): 10% max.			
Current consumption	45 mA max.			
Sensing distance adjustment range *2	20% to 100% of rated sensing distance 4-turn potentiometer			
Control outputs	Load current	NPN open collector, 100 mA max. (40 VDC max.)		
	Residual voltage	0.8 V max.		
Indicators	Detection indicator (red)			
Operation mode	Changed with NO/NC switch.			
Cable length compensation	Switched between 3 and 5 m.			
Ambient temperature range	Operating/storage: -10 to 55°C (with no icing or condensation)			
Ambient humidity range	Operating/storage: 35% to 85% (with no condensation)			
Temperature influence	±0.08%/°C			
Voltage influence	±2% max. of sensing distance at rated voltage in the rated voltage ±20% range			
Insulation resistance	50 MΩ min. (at 500 VDC) between current-carrying parts and case			
Dielectric strength	1,000 VAC, 50/60 Hz for 1 min between current-carrying parts and case			
Vibration resistance	Destruction: 10 to 55 Hz, 1.5-mm double amplitude for 2 hours each in X, Y, and Z directions			
Shock resistance	Destruction: 100 m/s ² 3 times each in X, Y, and Z directions			
Degree of protection	IEC 60529 IP20			
Connection method	Pre-wired Models (Cable length: 2 m)			
Weight (packed state)	Approx. 80 g			
Accessories	Caution labels, Mounting Bracket, instruction manual			

*1. A full-wave rectification power supply of 24 VDC ±10% (average value) can be used.

*2. The sensing distance range required to maintain performed is given for using the Amplifier Unit in combination with the Sensor.

Cable Lengths for Sensor-Amplifier Unit Combinations

Standard Models

Sensor Amplifier Units	E2C-CR5B	E2C-CR8A	E2C-CR8B	E2C-X1A	E2C-C1A	E2C-X1R5A	E2C-X2A	E2C-X5A	E2C-X10A	E2C-C20MA
E2C-GE4B	Restricted to 3 m.	---	---	---	---	---	---	---	---	---
E2C-GF4B		---	---	---	---	---	---	---	---	---
E2C-GE4A	---	Restricted to 3 m.					---	---	---	---
E2C-GF4A	---	Restricted to 3 m.					---	---	---	---
E2C-WH4A	---	Restricted to 3 m or 5 m. Set cable length switch to desired position. *					---	---	---	---
E2C-JC4AP	---	1 to 3 m: Short cable length terminals * 3 to 5 m: Open cable length terminals *					---	---	---	---
E2C-JC4A	---	Restricted to 3 m.					---	---	---	---
E2C-AM4A	Restricted to 3 m or 5 m. All pins set to left.	0 to 5 m Set cable length switch to desired position. *				0 to 10 m Set cable length switch to desired position. *				
E2C-AK4A		0 to 5 m Set cable length switch to desired position. *				0 to 10 m Set cable length switch to desired position. *				

Note: The standard cable length is 3 m. Models with 5-m or 10-m are manufactured upon order.
* Refer to page 14 for the operation of cable length switching.

Heat-resistant Models

Sensor Amplifier Units	E2C-X1R5AH	E2C-X2AH	E2C-X5AH
E2C-JC4CH	Set 3 m/5 m cable length switch to desired position.		
E2C-JC4DH			
E2C-JC4EH			

Note: The standard cable length is 3 m. Models with 5-m are manufactured upon order.

Self-diagnostic Function

The self-diagnostic output transistor will turn ON in the following cases. (The output will turn ON for any of these conditions individually.)

(1) Sensor open circuit: Transistor will turn ON the instance there is an open circuit for the Sensor (including the cable).

Sensor Open Circuit

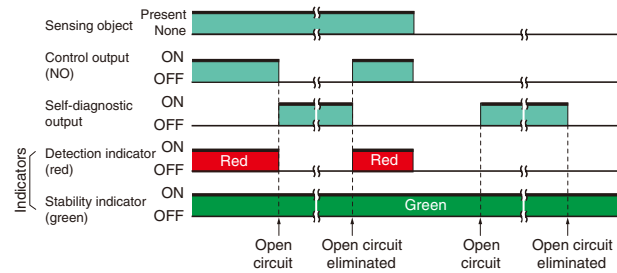

Sensor Connected

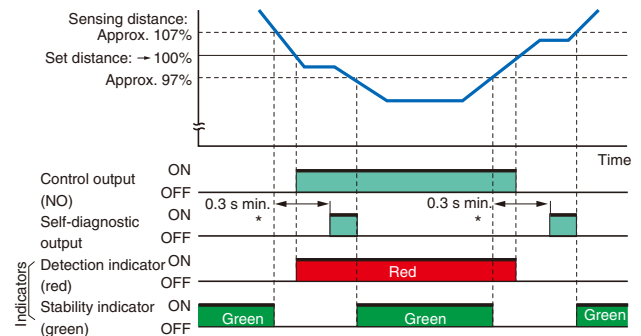

Note: When the E2C-X2A Sensor is used, 93% is 96% and 107% is 104%.
* The self-diagnostic output may turn ON if the sensing objects moves a low speed. In actual application, include an ON-delay timer circuit or other suitable measure.

(2) Detection: The output will turn ON if a sensing object is within 93% to 100% of the sensing distance continuously for 0.3 s or longer (e.g., for sensing object position offset).

(3) No detection: The output will turn ON if a sensing object is within 100% to 107% of the sensing distance continuously for 0.3 s or longer (e.g., when background is influencing detection).

Indicators

- The detection indicator lights when a sensing object approaches the sensing distance to indicate that a sensing object has been detected.
- The stability indicator lights when the sensing object approaches within 93% of the sensing distance or moves away from 107% of the sensing distance to indicate a stable sensing or non-sensing condition.

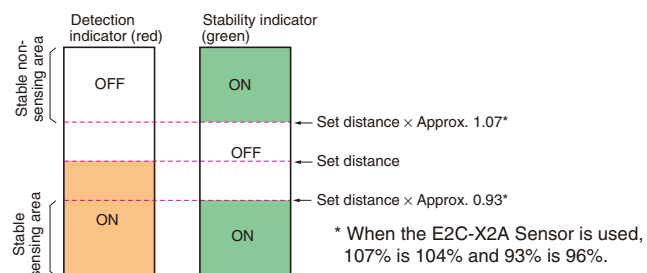

* When the E2C-X2A Sensor is used, 107% is 104% and 93% is 96%.

Engineering Data (Typical)

Sensing Area

E2C-CR5B

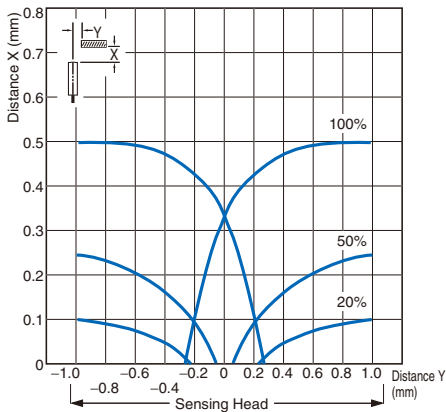

E2C-CR8

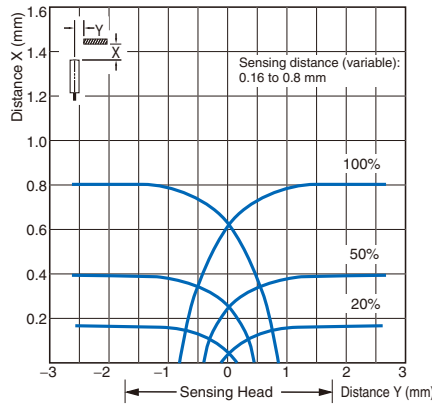

E2C-X1A/C1A

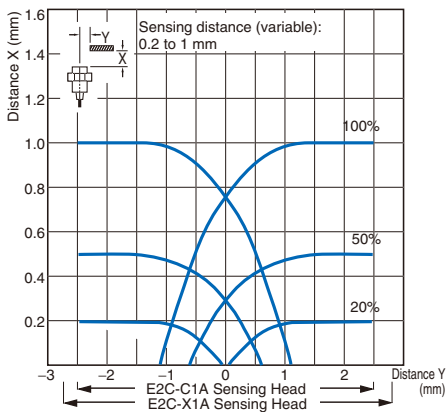

E2C-X1R5A

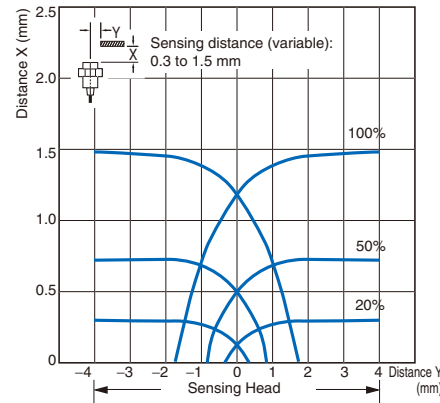

E2C-X2A

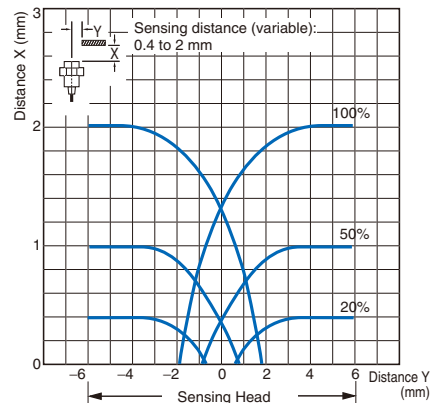

E2C-X5A

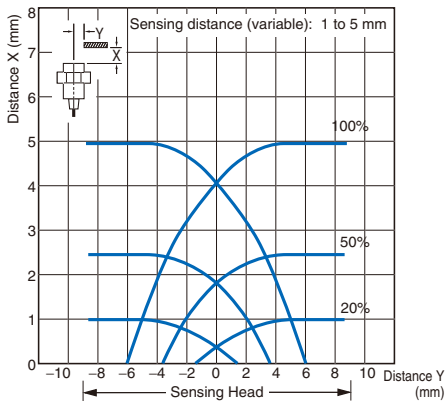

E2C-X10A

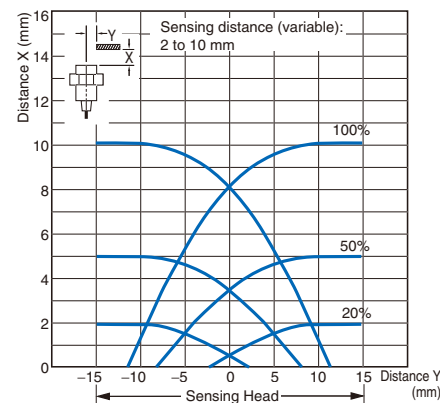

E2C-C20MA

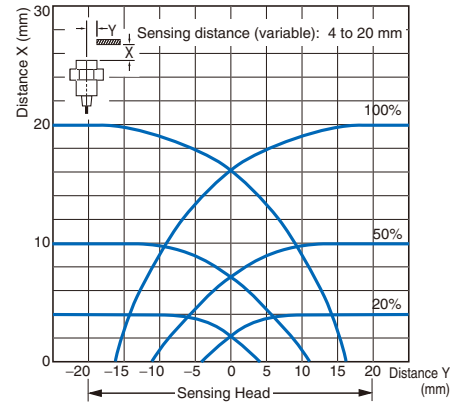

E2C-X1R5AH + E2C-JC4CH

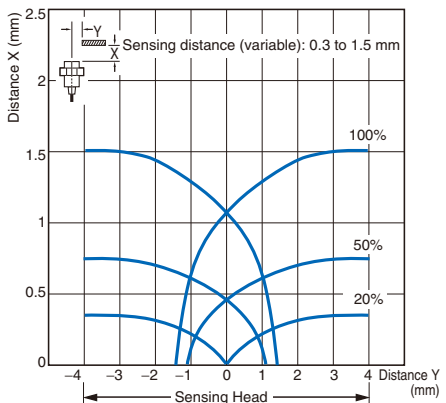

E2C-X2AH + E2C-JC4DH

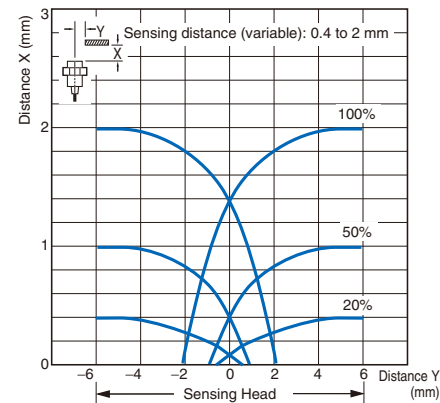

E2C-X5AH + E2C-JC4EH

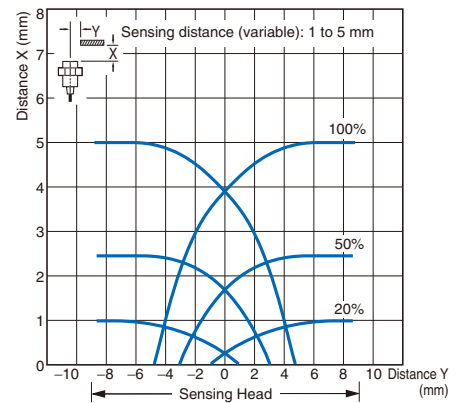

Influence of Sensing Object Size and Material

E2C-CR5B

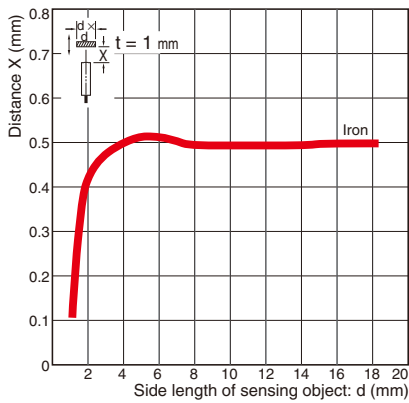

E2C-CR8

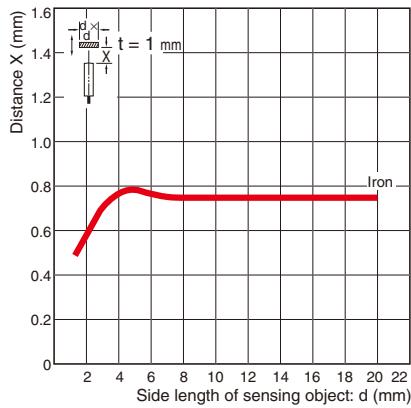

E2C-X1A/-C1A

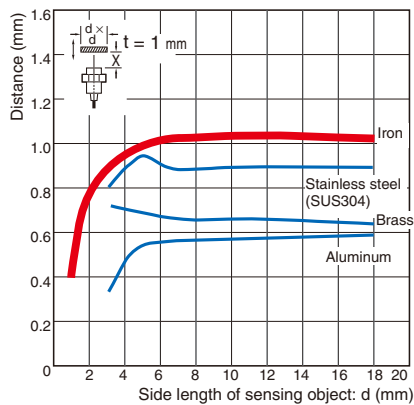

E2C-X1R5A

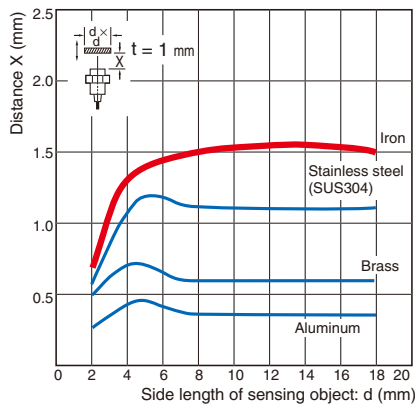

E2C-X2A

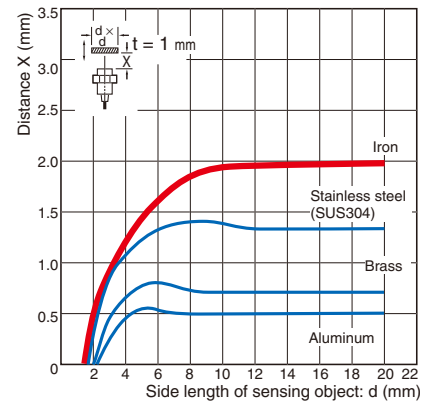

E2C-X5A

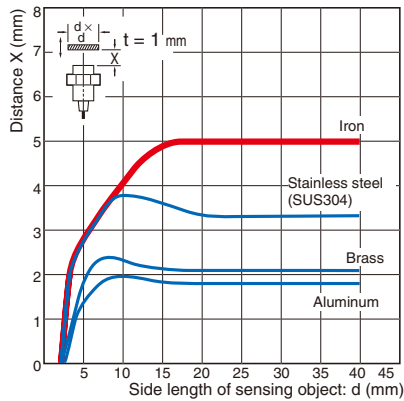

E2C-X10A

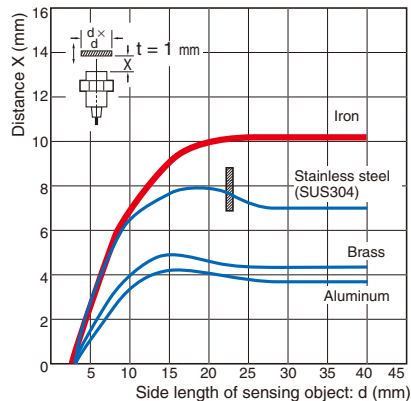

E2C-C20MA

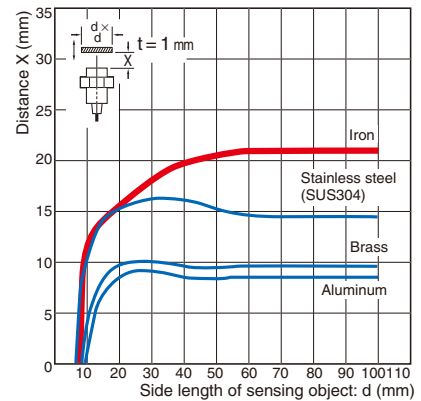

E2C-X1R5AH + E2C-JC4CH

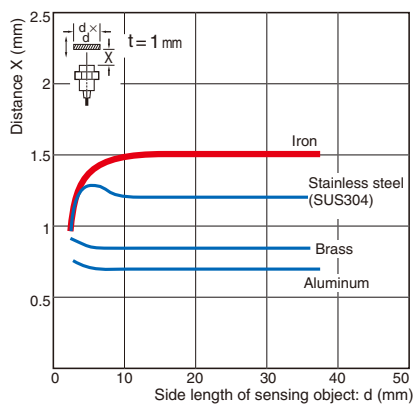

E2C-X2AH + E2C-JC4DH

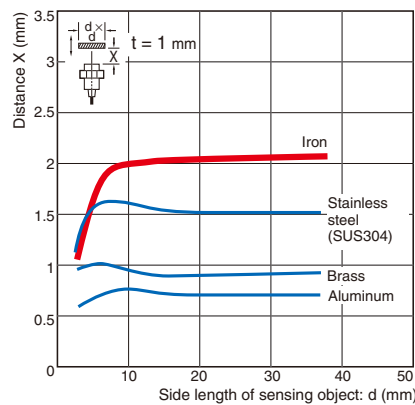

E2C-X5AH + E2C-JC4EH

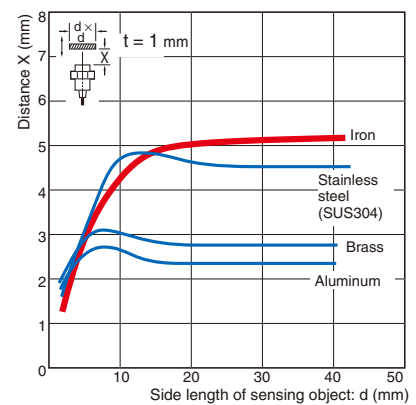

I/O Circuit Diagrams

Output configuration	E2C-GE4□ *	E2C-JC4A, E2C-JC4CH, E2C-JC4DH, E2C-JC4EH
NPN output	<p>* A voltage output can be used if the NO/NC switch on the E2C-GE4□ is set to NC, but an approximately 60-ms pulse will be generated when the power supply is turned ON. An initial reset will thus be required. If the E2C-GF4□ (model for PNP output) is used, the initial pulse will not occur.</p>	
NPN output Self-diagnosis Function	<p style="text-align: center;">E2C-JC4AP</p> <p style="text-align: center;">$Z_0: V_z = 40\text{ V}$</p>	
PNP Output	<p style="text-align: center;">E2C-GF4□</p>	
Both NPN and PNP outputs	<p style="text-align: center;">E2C-WH4A</p>	<p style="text-align: center;">E2C-AM4A</p>
Transistor/ photocoupler Relay output	<p style="text-align: center;">E2C-AK4A</p> <p>Note: Terminals 1, 2, and 3 are the relay contact output (SPDT).</p>	

Connections between Amplifier Unit and Sensor

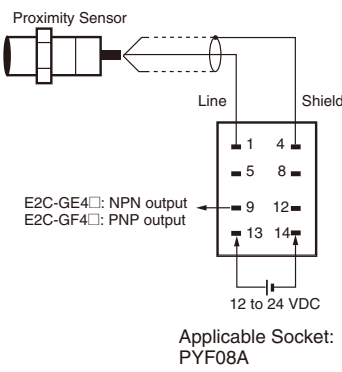
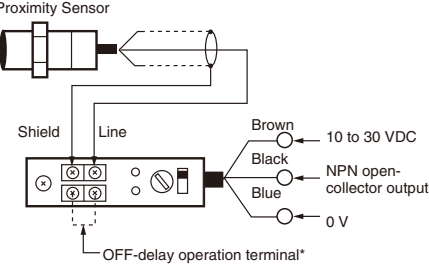
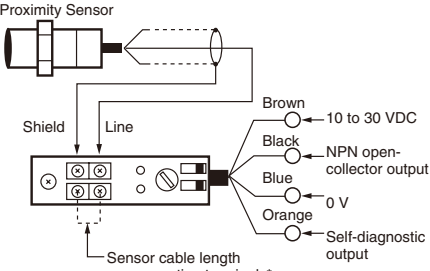
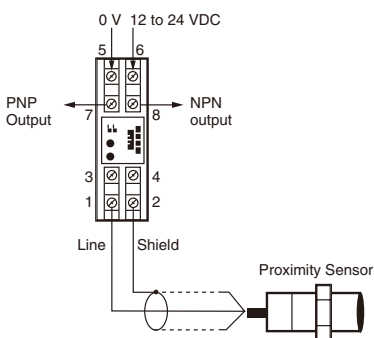
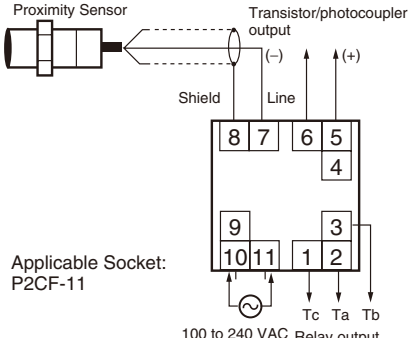
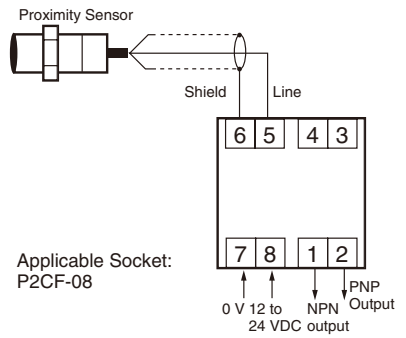
E2C-G□4	E2C-JC4A	E2C-JC4AP
 <p>Proximity Sensor</p> <p>Line Shield</p> <p>1 4 5 8 9 12 13 14</p> <p>E2C-GE4□: NPN output E2C-GF4□: PNP output</p> <p>12 to 24 VDC</p> <p>Applicable Socket: PYF08A</p>	 <p>Proximity Sensor</p> <p>Shield Line</p> <p>Brown → 10 to 30 VDC Black → NPN open-collector output Blue → 0 V</p> <p>OFF-delay operation terminal*</p> <p>* OFF-delay timer setting If the OFF-delay operation terminals are shorted, a 40-ms OFF-delay timer will start.</p>	 <p>Proximity Sensor</p> <p>Shield Line</p> <p>Brown → 10 to 30 VDC Black → NPN open-collector output Blue → 0 V Orange → Self-diagnostic output</p> <p>Sensor cable length compensation terminals*</p> <p>* Sensor Cable Length Compensation These terminals can be use to switch the cable length. Terminals shorted: 1 to 3 m Terminals open: 3 to 5 m</p>
 <p>0 V 12 to 24 VDC</p> <p>PNP Output → 7 NPN Output → 8</p> <p>1 2 3 4 5 6</p> <p>Line Shield</p> <p>Proximity Sensor</p> <p>Applicable Socket: P2CF-11</p>	 <p>Proximity Sensor</p> <p>Shield Line</p> <p>Transistor/photocoupler output (-) (+)</p> <p>8 7 6 5 4</p> <p>9 3 10 11 1 2</p> <p>100 to 240 VAC Relay output</p> <p>Applicable Socket: P2CF-11</p>	 <p>Proximity Sensor</p> <p>Shield Line</p> <p>6 5 4 3</p> <p>7 8 1 2</p> <p>0 V 12 to 24 VDC output</p> <p>PNP Output</p> <p>Applicable Socket: P2CF-08</p>

E2C-JC4□H

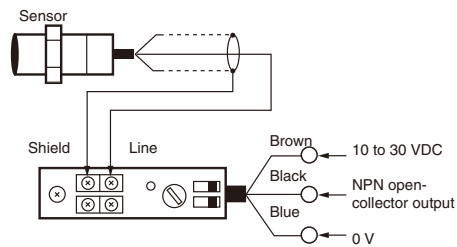

Note: Characteristics will change if the cable length changes. Do not cut or extend the cable.

Load Connections

Model	E2C-JC4A, E2C-JC4□H
Load DC load • Relay • Solenoid Current-sinking load • Programmable Controller • Sensor Controller	
Voltage load (logic circuit)	

Model	E2C-WH4A
Load DC load • Relay • Solenoid	<p>* Use 40 V maximum when connecting the load to a separate power supply.</p>
Solid-state load • Programmable Controller • Sensor Controller (S3D8)	<p>* For a current-sourcing load, connect the PNP output.</p>
Voltage load (logic circuit)	

Note: The E2C-WH4A supports both NPN and PNP open-collector output. It can be connected to a wide variety of load types and power polarities.

Model	E2C-GE4□
Load DC load • Relay • Solenoid	
Solid-state load • Programmable Controller • Sensor Controller	
Voltage load (logic circuit)	<p> I_C: 20 mA max. H_{FE}: 50 mA max. V_{CE0}: 30 V min. </p>
Remarks	When connecting to a CMOS IC or TLL, provide an interface circuit as shown above and connect to the solid-state circuit in the next stage.

Load	Model	E2C-AK4A	E2C-AM4A
DC load • Relay • Solenoid			
		<p>* Use 40 V maximum when connecting the load to a separate power supply.</p>	
Solid-state load • Programmable Controller • Sensor Controller			
		<p>* For a current-sourcing load, connect to the negative side of the transistor/photocoupler output.</p>	<p>* For a current-sourcing load, connect the PNP output.</p>
Voltage loads (logic circuit)			

The E2C-AK4A supports relay and transistor/photocoupler outputs, and the E2C-AM4A supports both NPN and PNP open-collector output. They can be connected to a wide variety of load types and power polarities.

Nomenclature and Timing Charts

Amplifier Units

E2C-G□4□

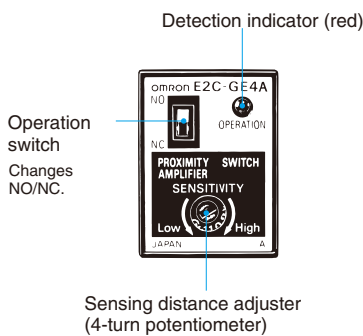

Timing Chart

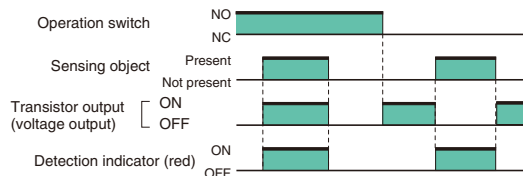

E2C-JC4A

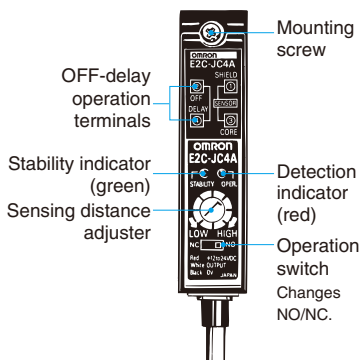

Timing Chart

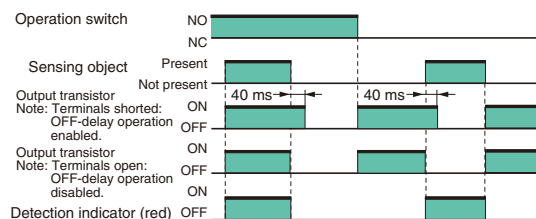

E2C-JC4AP

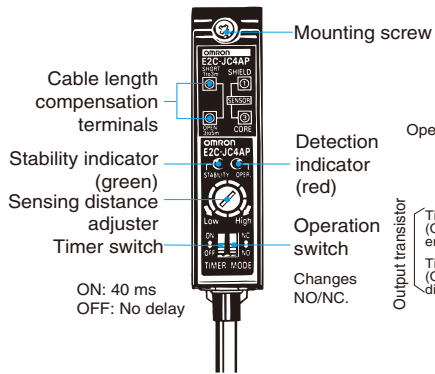

Timing Chart

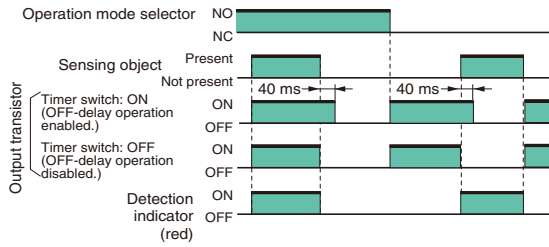

E2C-WH4A

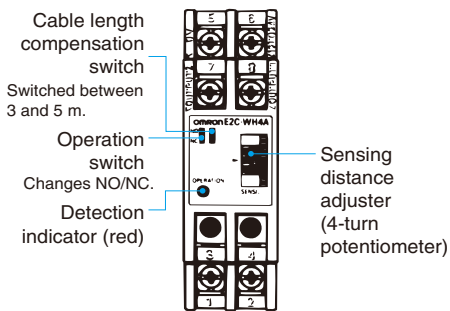

Timing Chart

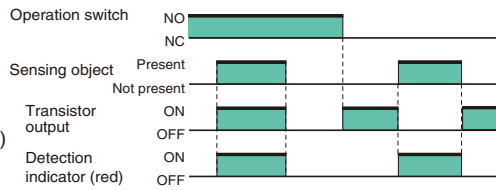

E2C-JC4CH, E2C-JC4DH, E2C-JC4EH

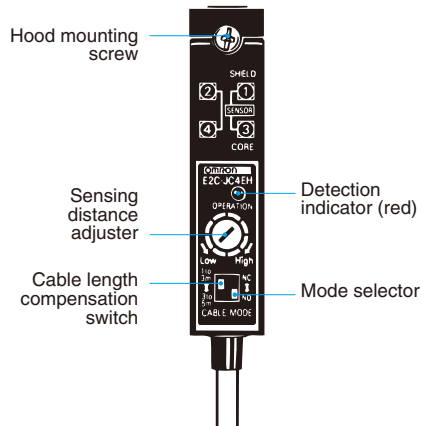

Timing Chart

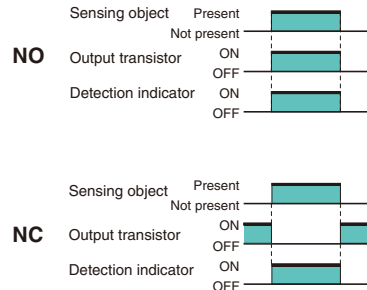

E2C-A□4A

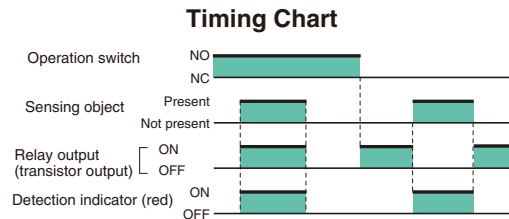
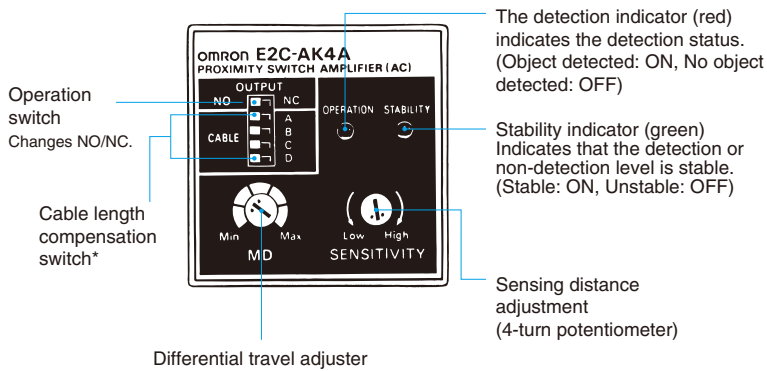

* Cable Length Compensation Switching
Set this switch to the proper setting depending on whether the standard cable length is being used or the cable has been cut shorter.

Amplifier Unit Switch Settings

Applicable Sensors	Cable length	0 to 1 m	1 to 2 m	2 to 3 m	3 to 4 m	4 to 5 m	5 to 6 m	6 to 7 m	7 to 8 m	8 to 9 m	9 to 10 m
E2C-CR8A E2C-CR8B E2C-X1A E2C-C1A E2C-X1R5A							—	—	—	—	—
E2C-X2A E2C-X5A E2C-X10A E2C-C20MA											

Note: 1. Mutual Interference Prevention: When mounting Sensors with the same diameter and cable length in parallel, set the DIP switch to modes that differ by 1 m in cable length. Specifications, however, may not be sufficiently met, so always check operation before actual application. This method cannot be used for the E2C-C20MA.
2. When using the E2C-CR5B + E2C-AM4A (or AK4A), set all the pins on the Amplifier Unit DIP switch to the left.

Safety Precautions

Refer to *Warranty and Limitations of Liability*.

⚠ WARNING

This product is not designed or rated for ensuring safety of persons either directly or indirectly. Do not use it for such purposes.



Precautions for Correct Use

Do not use the Encoder under ambient conditions that exceed the ratings.

● Design

Influence of Surrounding Metal

When mounting the Sensor within a metal panel, ensure that the clearances given in the following table are maintained. Failure to maintain these distances may cause deterioration in the performance of the Sensor.

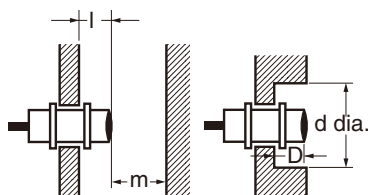

Influence of Surrounding Metal (Unit: mm)

Model	Distance	l	d	D	m
E2C-CR5B		2	6	2	1.5
E2C-CR8			(3.5)		2.4
E2C-X1A			(5)		3
E2C-C1A			(5.4)		
E2C-X1R5A(H)	0		(8)	0	4.5
E2C-X2A(H)			(12)		6
E2C-X5A(H)			(18)		15
E2C-X10A			(30)		30
E2C-C20MA	25		120	40	60

Note: Values in parentheses for diameter d are the outer diameters of Shielded Models.

Mutual Interference

When installing Sensors face-to-face or side-by-side, ensure that the minimum distances given in the following table are maintained. Mutual interference can be prevented by using the cable length compensation switch, but doing so will also change coil characteristics. Specifications such as temperature specifications and sensing distance, may not be sufficiently met, so always check operation before actual application.

This method cannot be used for the E2C-G□4A, E2C-JC4A, E2C-CR5B, E2C-C20MA.

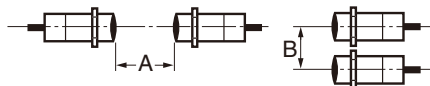

Mutual Interference (Unit: mm)

Model	Distance	A	B
E2C-CR5B			
E2C-CR8			
E2C-X1A		20	15
E2C-C1A			
E2C-X1R5A(H)			
E2C-X2A(H)		30	20
E2C-X5A(H)		50	35
E2C-X10A		100	70
E2C-C20MA		300	200

Note: The above values are for a differential travel setting of 5%.

Mounting

- Do not use excessive force when tightening the nuts on the E2C-X and E2C-C20MA. A washer must be used with the nut.



Model	Torque
E2C-X1A	0.98 N·m
E2C-X1R5A(H)	2.0 N·m
E2C-X2A(H)	5.9 N·m
E2C-X5A(H)	15 N·m
E2C-X10A	39 N·m
E2C-C20MA	15 N·m

Note: The above leeways in tighten torque assume that a toothed washer is being used.

● Mounting Unthreaded Cylindrical Models

When using a set screw, tighten it to a torque of 0.2 N·m max.

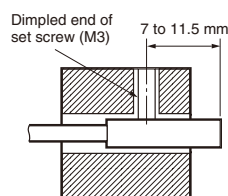

Y92E-F3R5 Mounting Bracket (for 3.5 dia.) (Order Separately)

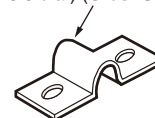

The Y92E-F5R4 (for 5.4 dia.) is also sold separately.

● Mounting

Mounting the Amplifier Unit

E2C-JC4A, E2C-JC4□H

Lengthwise Mounting

- (1) Secure the Mounting Bracket with the enclosed M3 screws.
- (2) Slide the protrusion on the Amplifier Unit into the holes on the Mounting Bracket.
- (3) Secure the Amplifier Unit with mounting screws.
- (4) Secure the cover to the case.

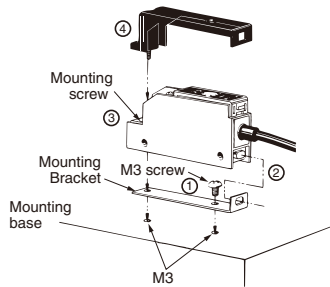

Mounting to the Side

- (1) Remove the cover screw and mounting screw.
- (2) Attached the enclosed M3 screw to the cover and secure the cover to the case.
- (3) Secure the Amplifier Unit with M3 screws from the side.

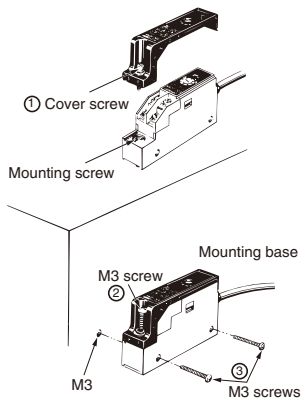

After completing adjustments, attach the enclosed caution label over the adjustment holes to prevent adjustment mistakes.



E2C-WH4A

Mounting Method

- (1) Mount to DIN Track as shown in the following diagram.
- (2) Hook part (A) at the top of the Amplifier Unit on the DIN Track first and then press in on the Amplifier Unit in the direction indicated by (B).

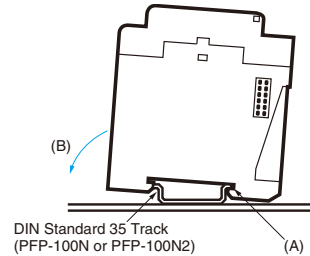

Removing the Amplifier Unit

- (3) Pull down on the track stopper (C) with a flat-blade screwdriver and then remove the Amplifier Unit from the DIN Track. When using DIN standard 35 track, keep other devices on the track separated from the Amplifier Unit by at least 30 mm to facilitate mounting and removal.

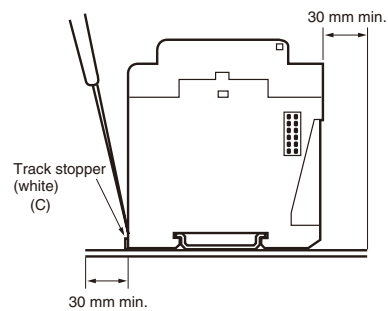

E2C-A□4A

Using P2CF-11, P2CF-08

When aligning the Amplifier Unit vertically with the Socket, consider the space required for the hooks and allow a leeway of about 20 mm above and below the Amplifier Unit.

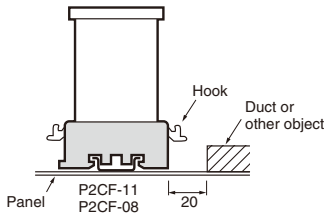

Mounting Embedded in a Panel

(1) When using the Y92F-30 Embedded Mounting Adapter, insert the Amplifier Unit into a square hold in the panel, attach the Adapter from the back and press in to reduce the gap with the panel. Then secure the Adapter with the screws.

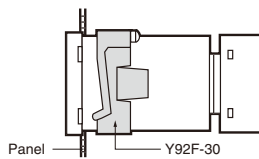

(2) When using the Y92F-70 or Y92F-71 Embedded Mounting Adapter, just press the Amplifier into a square hole in the panel. If the panel coating is too thick and the hooks do not lock in place, spread the hooks from the back by pushing in the directions of the arrows.

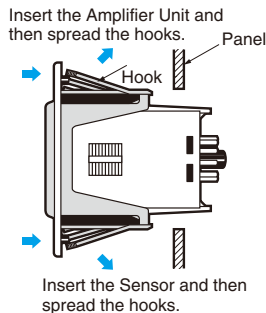

Removing the Amplifier Unit

- When the Amplifier Unit is mounted using the Y92F-30, loosen the screws on the adapter, spread the hooks at the top and bottom, and remove the Adapter.

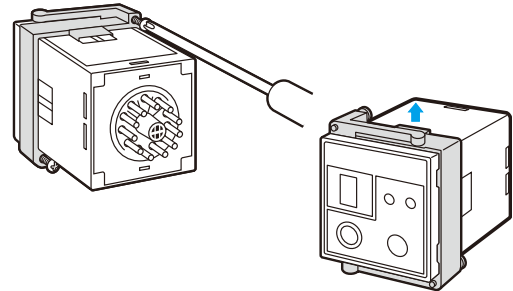

- Using Y92F-70, Y92F-71
Press in on the hooks with your thumb and forefinger and press forward on the Amplifier Unit.

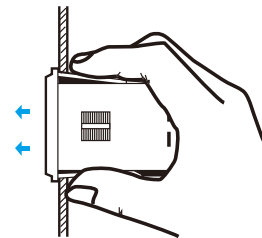

● Wiring

Self-diagnostic Output

When not using the self-diagnostic output, connect the orange wire to 0 V or cut it and wrap it with insulation tape so that it does not come into contact with other terminals.

● Miscellaneous

The sensor does not have a water-resistant structure. Do not use it where it would be subjected to water or water vapor.

Dimensions

Main Units

Sensor

E2C-CR5B

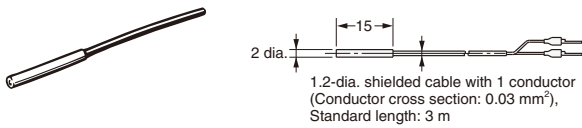

E2C-CR8A/-CR8B

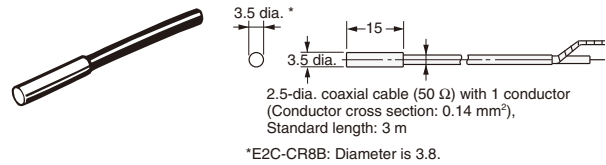

E2C-X1A

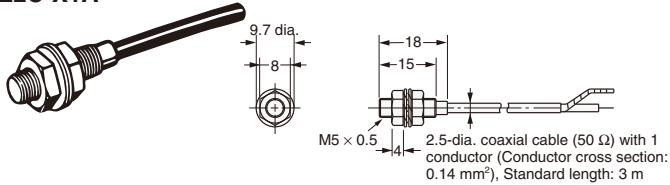

E2C-C1A

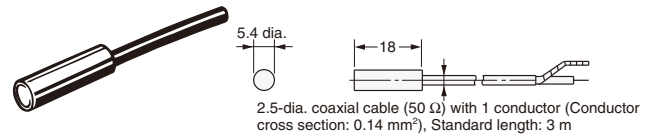

E2C-X1R5A

E2C-X1R5AH*

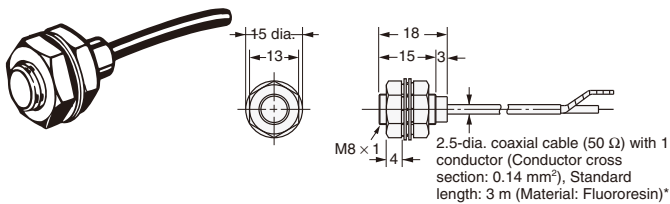

E2C-X2A

E2C-X2AH*

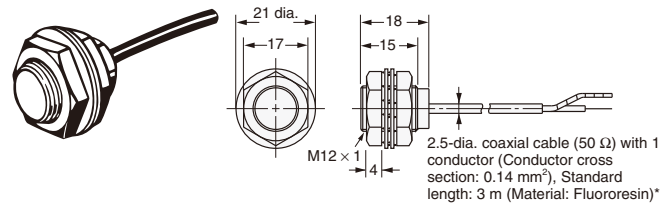

E2C-X5A

E2C-X5AH*

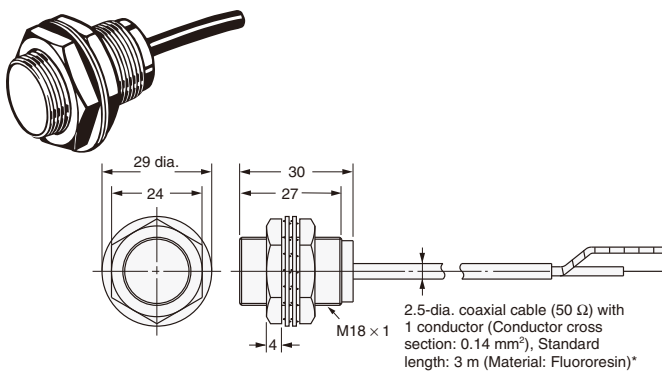

E2C-X10A

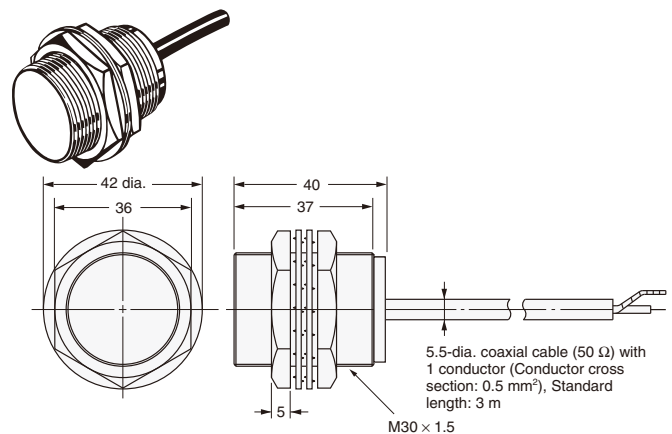

E2C-C20MA

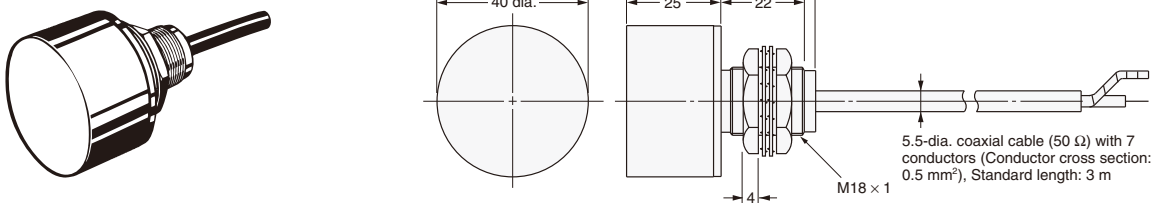

Mounting Hole Dimensions

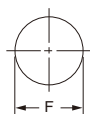

Model	F (mm)	Model	F (mm)	Model	F (mm)
E2C-CR5B	2.2-dia. $^{+0.3}_0$	E2C-X1A	5.4-dia. $^{+0.5}_0$	E2C-X5A	18.5-dia. $^{+0.5}_0$
E2C-CR8A	3.7-dia. $^{+0.3}_0$	E2C-X1R5A	8.5-dia. $^{+0.5}_0$	E2C-X10A	30.5-dia. $^{+0.5}_0$
E2C-CR8B	4.0-dia. $^{+0.3}_0$	E2C-X2A	12.5-dia. $^{+0.5}_0$	E2C-C20MA	18.5-dia. $^{+0.5}_0$
E2C-C1A	5.7-dia. $^{+0.3}_0$				

Amplifier Units

E2C-GE4A, -GE4B
E2C-GF4A, -GF4B

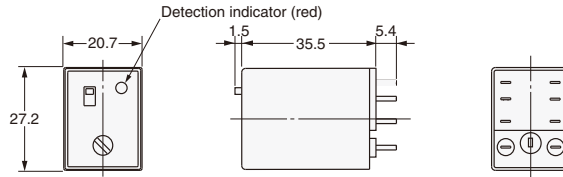
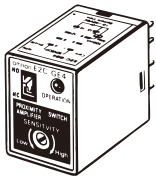

Applicable Sockets (Sold Separately)

- PYF08A

Hold-down Clip

- PYC-A1

E2C-AK4A (11-pin)
E2C-AM4A (8-pin)

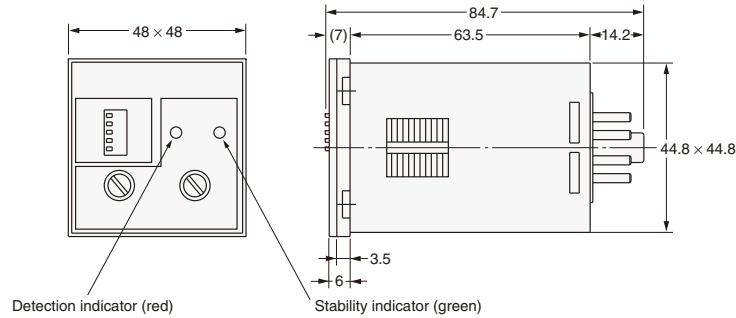
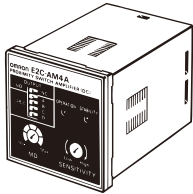

Applicable Sockets (Sold Separately)

For E2C-AK4A (11-pin)

- P2CF-11
- P3GA-11

For E2C-AM4A (8-pin)

- P2CF-08
- P3G-08

E2C-JC4A

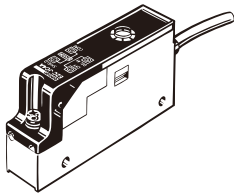

Mounting Bracket Installation

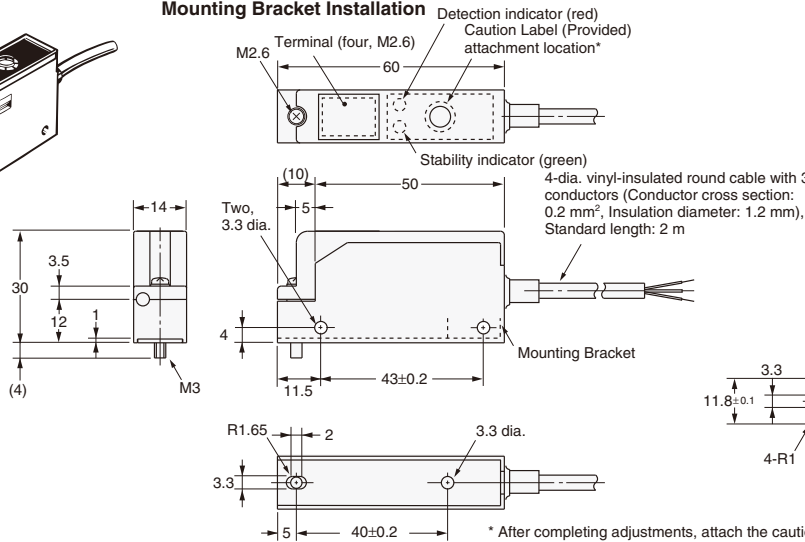

Mounting Bracket (Iron)

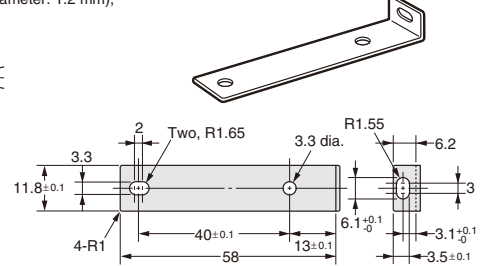

* After completing adjustments, attach the caution label to prevent adjustment mistakes.

E2C-JC4AP

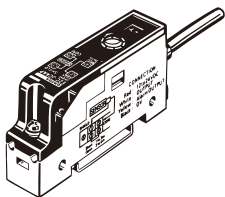

Mounting Bracket Installation

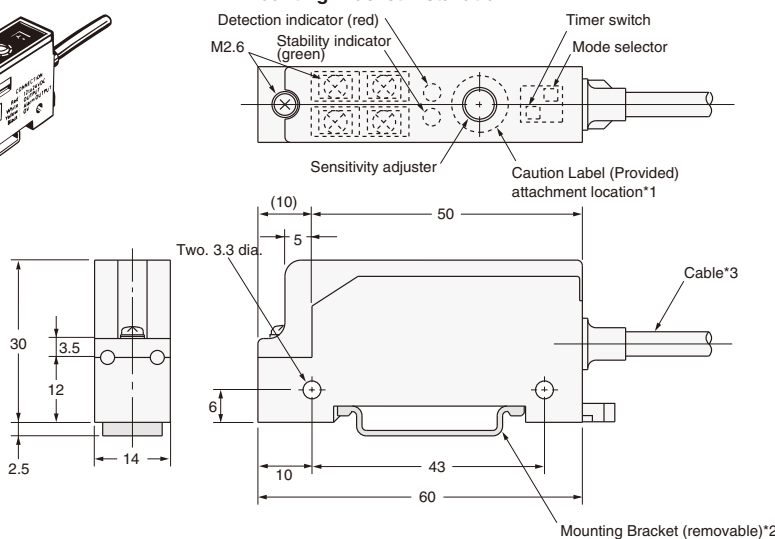

Mounting Bracket (Iron)

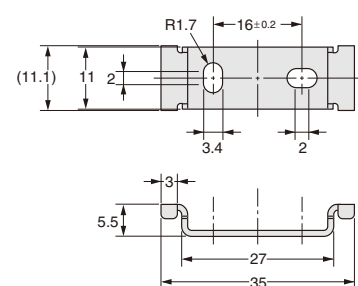

*1. After completing adjustments, attach the caution label to prevent adjustment mistakes.

*2. Not required when mounting to DIN Track.

*3: 4.5-dia. vinyl-insulated round cable with 4 conductors (Conductor cross section: 0.2 mm², Insulator diameter: 1.2 mm), Standard length: 2 m

E2C-JC4□H

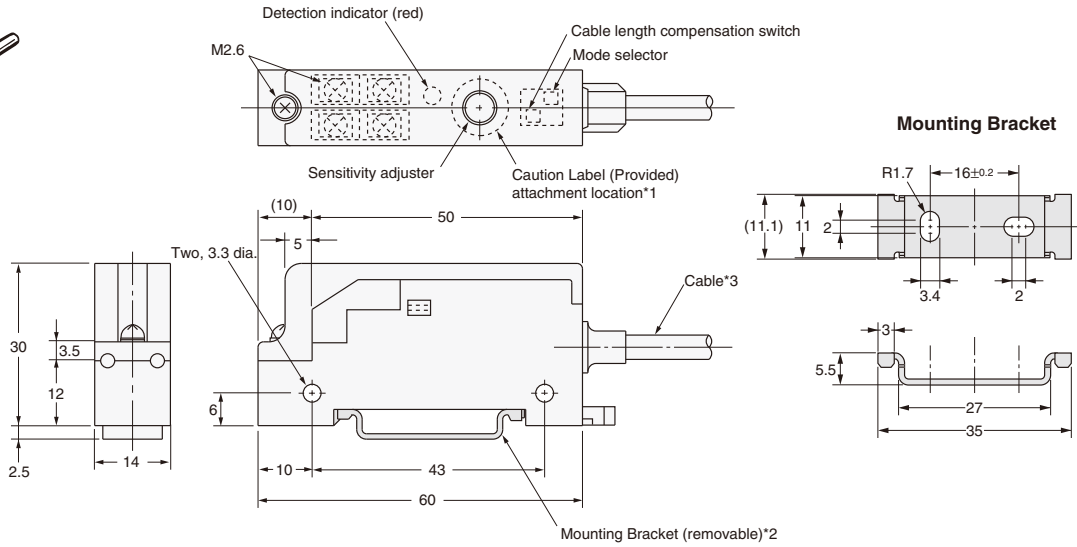
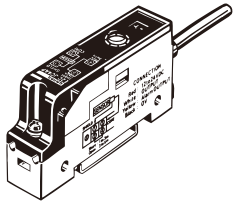

- *1. After completing adjustments, attach the caution label to prevent adjustment mistakes
- *2. Not required when mounting to DIN Track.
- *3. 4-dia. vinyl-insulated round cable with 3 conductors (Conductor cross section: 0.2 mm², Insulator diameter: 1.2 mm), Standard length: 2 m
The cable can be extended up to 200 m (separate metal conduit).

E2C-WH4A

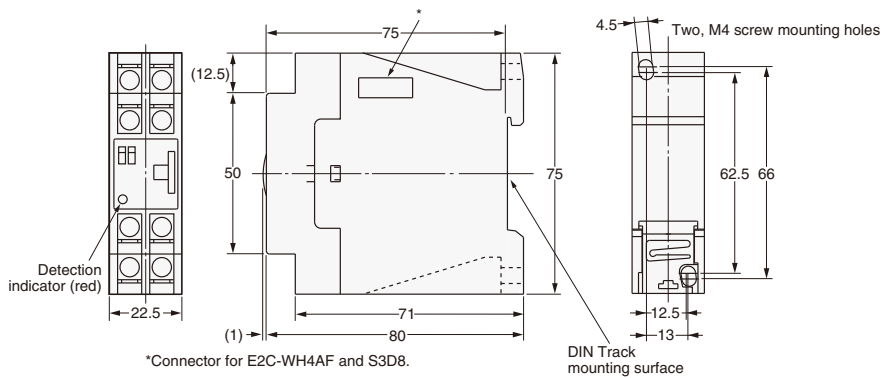
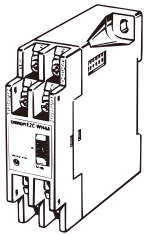

Accessories (Order Separately)

Mounting Bracket

Mounting Bracket (for Unthreaded Cylindrical Models)

Y92E-F3R5 (for 3.5 dia.)

Y92E--F5R4 (for 5.4 dia.)

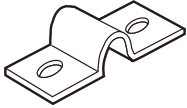

Y92E-F3R5

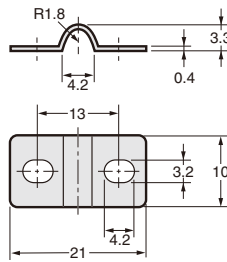

Y92E-F5R4

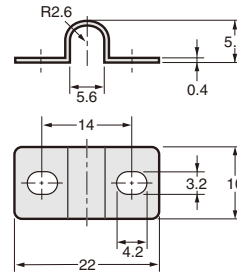

Front Connection Sockets

PYF08A

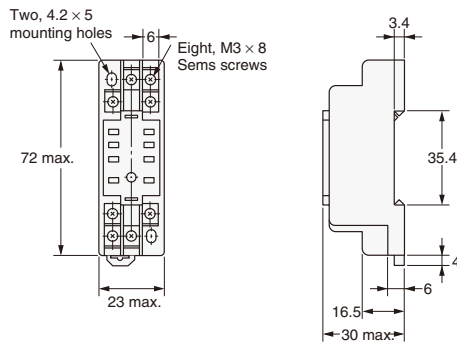
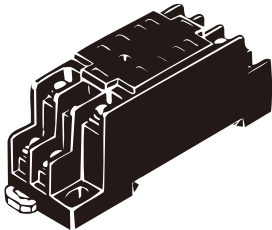

Terminal Arrangement and Internal Connections (Top View)

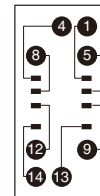

Mounting Hole Dimensions

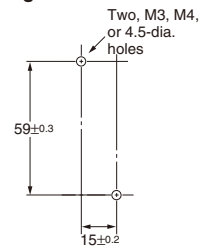

Note: Track mounting is also possible.

P2CF-08

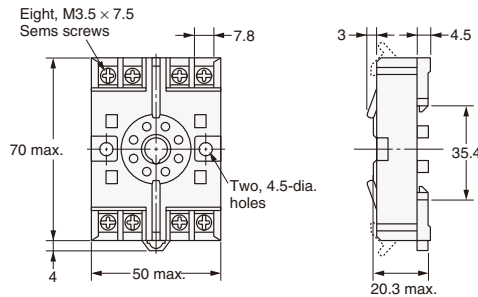
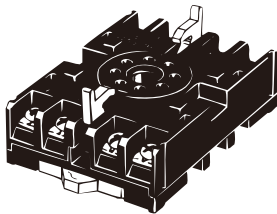

Terminal Arrangement and Internal Connections (Top View)

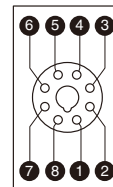

Mounting Hole Dimensions

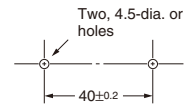

Note: Track mounting is also possible.

P2CF-11

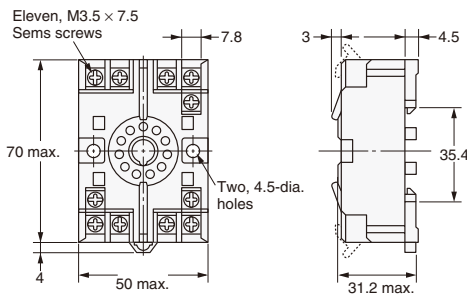
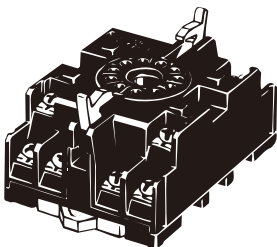

Terminal Arrangement and Internal Connections (Top View)

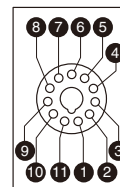

Mounting Hole Dimensions

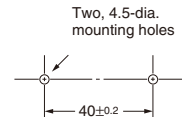

Note: Track mounting is also possible.

Back Connection Sockets

P3G-08

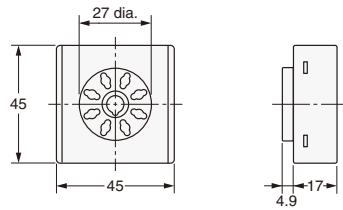
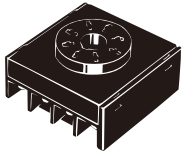

Terminal Arrangement and Internal Connections (Bottom View)

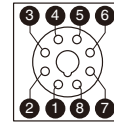

P3GA-11

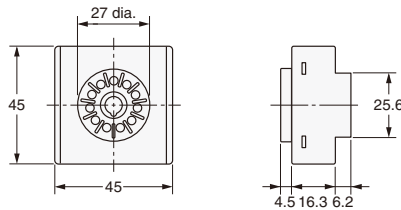
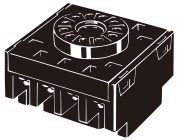

Terminal Arrangement and Internal Connections (Bottom View)

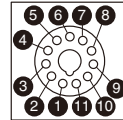

Embedded Mounting Adapter (for E2C-AK4A/E2C-AM4A Amplifier Unit)

Y92F-30

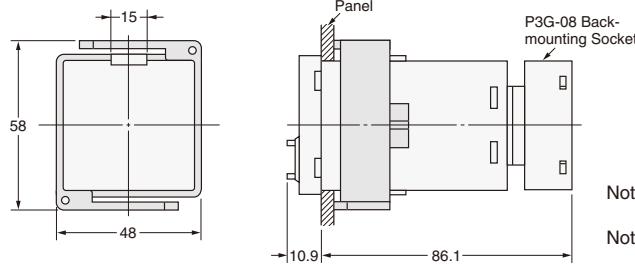
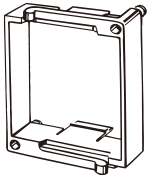

Mounting Hole Dimensions

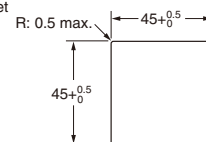

Note 1. Suitable mounting panel thickness: 1 to 5 mm

Note 2. Check the direction of the Adapter, which depends on whether Amplifier Units are arranged vertically or horizontally.

Y92F-70

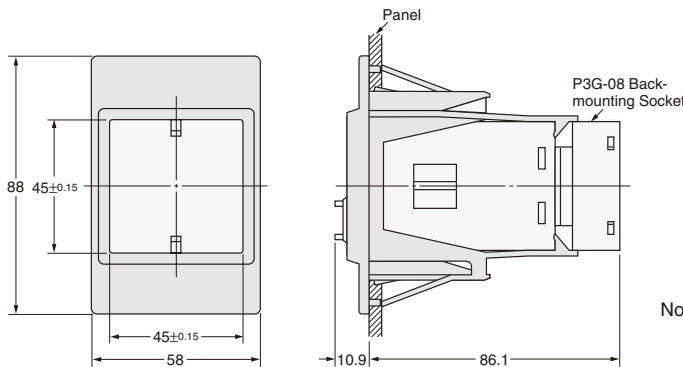
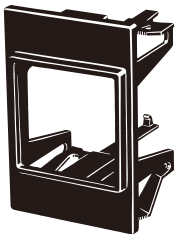

Mounting Hole Dimensions

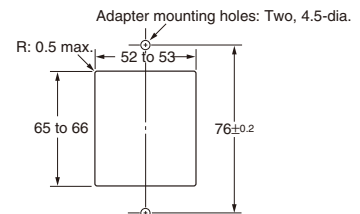

Note: Suitable mounting panel thickness: 1 to 3.2 mm

Y92F-71

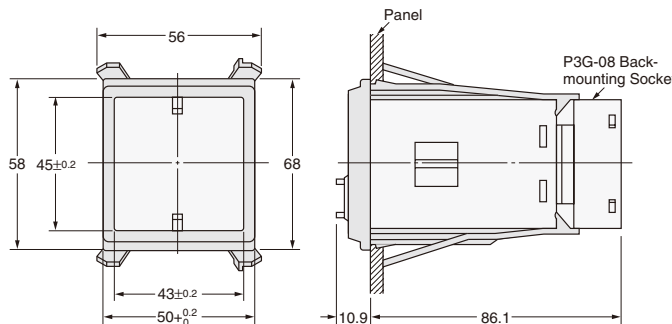

Mounting Hole Dimensions

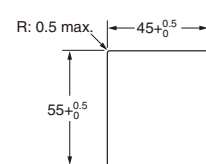

Note: Suitable mounting panel thickness: 1 to 3.2 mm

E2C/E2C-H

Amplifier Unit Initial Adjustment

Initial Adjustment after Turning ON the Power

After turning ON the Amplifier Unit, make the following adjustments according to the indicator status without a sensing object.

E2C-G□4□ Single-function Model/E2C-WH4A (F) Multi-function Model		E2C-JC4A Multi-function Model/E2C-A□4A Multi-function Model			
Status of Indicators	Operation	Status of Indicators		Operation	
Detection indicator (red) (OPERATION)	Sensitivity adjuster	Mode indicator	Detection indicator (red)	Stability indicator (green)	Sensitivity adjuster
Lit	Turn the sensitivity adjuster counterclockwise until the operation indicator turns OFF.	A	Lit	Lit	Turn the sensitivity adjuster counterclockwise to put the Amplifier Unit in mode D.
Not lit	No adjustment is required.	B	Lit	Not lit	
		C	Not lit	Not lit	
		D	Not lit	Lit	No adjustment is required.

Amplifier Unit Sensitivity Adjustment

E2C-G□4□ Single-function Model

Step Item	(1)	(2)	(3)
Detection state			
Sensitivity adjuster	---		---
Operation	Obtain the sensing distance X from the set distance S divided by 0.8. Determine S so that X will be less than the maximum sensing distance.	Locate the Sensor so that the distance between the Sensor and sensing object is X. Turn the sensitivity adjuster toward High (clockwise) until the operation indicator is lit.	Return the Sensor to the previous position so that the distance between the Sensor and sensing object is S. Secure the position of the Sensor to complete the sensitivity adjustment.

E2C-WH4A(F) Multi-function Model

Step Item	(1)	(2)	(3)
Detection state			
Sensitivity adjuster	---		---
Operation	Obtain the sensing distance X from the set distance S divided by 0.8. Determine S so that X will be less than the maximum sensing distance.	Locate the Sensor so that the distance between the Sensor and sensing object is X. Turn the sensitivity adjuster in the direction of the arrow until the operation indicator is lit.	Return the Sensor to the previous position so that the distance between the Sensor and sensing object is S. Secure the position of the Sensor to complete the sensitivity adjustment.



Note: If the Amplifier Unit malfunctions due to radical ambient temperature changes, further shorten the distance between the Sensor and sensing object to 80% maximum of the set distance.

E2C-A□4A and E2C-JC4A Multi-function Models, E2C-JC4□H Heat-resistance Model

Step Item	(1)	(2)	(3)	(4)
Detection state	---			
Sensitivity adjuster				---
Operation	Set the MD adjuster to the center between "Min" and "Max."	Locate the sensing object in the adjustment range of sensing distance and turn the sensitivity adjuster toward High (clockwise) until the red operation indicator is lit.	Move the sensing object for a necessary differential travel distance (i.e., 1% to 5% of the rated sensing distance) and turn the MD adjuster slowly toward Min until the red operation indicator turns OFF. Then move the sensing object and check that the Sensor detects the object when the object is in the sensing distance range.	Shorten the distance between the Sensor and sensing object and fix the position of the Sensor where both the red operation indicator and green stability indicator are lit to complete the sensitivity adjustment.

Note: If the Amplifier Unit malfunctions due to radical ambient temperature changes, further shorten the distance between the Sensor and sensing object to 80% maximum of the set distance. The E2C-JC4A has no function to adjust differential travel. Therefore, perform steps 2 and 4 only.

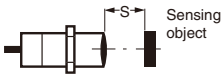
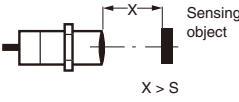
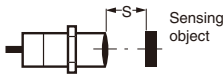
E2C-JC4AP Self-diagnostic Output

Step Item	(1)	(2)	(3)
Detection state			
Sensitivity adjuster	---		---
Operation	Obtain the sensing distance X from the set distance S divided by 0.8. Determine S so that X will be less than the maximum sensing distance.	Locate the Sensor so that the distance between the Sensor and sensing object is X. Turn the sensitivity adjuster clockwise or counterclockwise until the red operation indicator is lit.	Return the Sensor to the previous position so that the distance between the Sensor and sensing object is S. Secure the position of the Sensor to complete the sensitivity adjustment. The green stability indicator must be lit when the sensing object is located within the sensing distance, and the red stability indicator must be lit when the object is completely outside the sensing distance.

Note: If the Amplifier Unit malfunctions due to radical ambient temperature changes, further shorten the distance between the Sensor and sensing object to 80% maximum of the set distance.

A caution label is provided with the E2C Amplifier Unit. After adjusting the sensitivity, attach the caution label over the adjuster hole of the cover to prevent misoperation of the E2C Amplifier Unit. (E2C-JC4A, E2C-JC4AP, E2C-JC4□H only)

Proximity Sensors Technical Guide

General Precautions For precautions on individual products, refer to the *Safety Precautions* in individual product information.

⚠ WARNING

These products cannot be used in safety devices for presses or other safety devices used to protect human life.



These products are designed for use in applications for sensing workpieces and workers that do not affect safety.

Precautions for Safe Use

To ensure safety, always observe the following precautions.

●Wiring Considerations

Item	Typical examples	
<p>Power Supply Voltage</p> <p>Do not use a voltage that exceeds the operating voltage range. Applying a voltage that is higher than the operating voltage range, or using an AC power supply (100 VAC or higher) for a Sensor that requires a DC power supply may cause explosion or burning.</p>	<p>DC 3-Wire NPN Output Sensors</p>	<p>DC 2-Wire Sensors</p>
<p>Load short-circuiting</p> <ul style="list-style-type: none"> Do not short-circuit the load. Explosion or burning may result. The load short-circuit protection function operates when the power supply is connected with the correct polarity and the power is within the rated voltage range. 	<p>DC 3-Wire NPN Output Sensors</p>	<ul style="list-style-type: none"> DC 2-Wire Sensors Even with the load short-circuit protection function, protection will not be provided when a load short circuit occurs if the power supply polarity is not correct.
<p>Incorrect Wiring</p> <p>Be sure that the power supply polarity and other wiring is correct. Incorrect wiring may cause explosion or burning.</p>	<p>DC 3-Wire NPN Output Sensors</p>	
<p>Connection without a Load</p> <p>If the power supply is connected directly without a load, the internal elements may explode or burn. Be sure to insert a load when connecting the power supply.</p>	<ul style="list-style-type: none"> DC 2-Wire Sensors Even with the load short-circuit protection function, protection will not be provided if both the power supply polarity is incorrect and no load is connected. 	<p>AC 2-Wire Sensors</p>

●Operating Environment

Do not use the Sensor in an environment where there are explosive or combustible gases.

Proximity Sensors Technical Guide

Precautions for Correct Use

The following conditions must be considered to understand the conditions of the application and location as well as the relation to control equipment.

●Model Selection

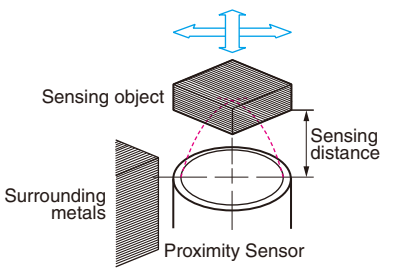
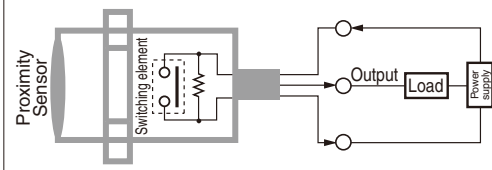
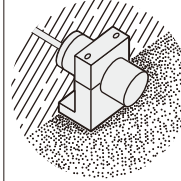
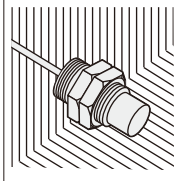
Item	Points of consideration				
<p>Sensing object and operating condition of Proximity Sensor</p> 	<p>Check the relation between the sensing object and the Proximity Sensor.</p>	<p>Specific conditions of object</p>	<p>Direction of object movement</p>	<p>Peripheral metal</p>	<p>Sensing distance</p>
<p>Electrical conditions</p> 	<p>Verify the electrical conditions of the control system to be used and the electrical performance of the Proximity Sensor.</p>	<p>Power supply</p>	<p>DC (voltage fluctuation, current capacity value) AC (voltage fluctuation, frequency, etc.) Need for S3D2 Controller</p>	<p>Load</p>	<p>Resistive load - Non-contact control system Inductive load - Relay, solenoid, etc. • Steady-state current, inrush current • Operating, reset voltage (current) Lamp load • Steady-state current, inrush current Open/close frequency</p> <p>Selecting the power supply type DC DC + S3D2 Controller AC</p> <p>Selecting the power supply type DC DC + S3D2 Controller AC</p> <p>Control output Maximum current (voltage) Leakage current Residual load voltage</p>
<p>Environmental conditions</p> 	<p>The environmental tolerance of the Proximity Sensor is better than that of other types of Sensors. However, investigate carefully before using a Proximity Sensor under harsh temperatures or in special atmospheres.</p>	<p>Temperature and humidity</p>	<p>Highest or lowest values, existence of direct sunlight, etc.</p>	<p>Temperature influence, high-temperature use, low temperature use, need for shade, etc.</p>	<p>• Water Resistance Do not use the Sensor in water, rain, or outdoors.</p> <p>• Ambient Conditions To maintain reliability of operation, do not use the Sensor outside the specified temperature range or outdoors. Even though the Proximity Sensor has a water-resistant structure, it must be covered to prevent direct contact with water or water-soluble cutting oil. Do not use the Sensor in atmospheres with chemical vapors, in particular, strong alkalis or acids (nitric acid, chromic acid, or hot concentrated sulfuric acid).</p> <p>• Explosive Atmospheres Do not use the Sensor in atmospheres where there is a danger of explosion. Use an Explosion-proof Sensor.</p>
<p>Mounting conditions</p> 	<p>Wiring method, existence of inductance surges</p>	<p>Wires</p>	<p>Wire type, length, oil-resistant cable, shielded cable, robot cable, etc.</p>	<p>Connection</p>	<p>When deciding the mounting method, take into consideration not only restrictions due to mechanical devices, but also ease of maintenance and inspection, and interference between Sensors.</p> <p>Mounting procedure</p> <p>Existence of mounting brackets, direct mounting, secured with bolts or screws</p> <p>Installation location</p> <p>Ease of maintenance and inspection, mounting space</p>
<p>Influence of external electromagnetic fields</p>	<p>• The influence within a DC magnetic field is 20 mT* max. Do not use the Sensor at a level higher than 20 mT. • Sudden changes in the DC magnetic field may cause malfunction. Do not use the Sensor for applications that involve turning a DC electromagnet ON and OFF. • Do not place a transceiver near the Sensor or its wiring. Doing so may cause malfunction.</p>				
<p>Other considerations</p>	<p>Cost feasibility: Price/delivery time Life: Power-ON time/frequency of use</p>				

* mT (millitesla) is a unit for expressing magnetic flux density. One tesla is the equivalent of 10,000 gauss.

●Design

Sensing Object Material

The sensing distance varies greatly depending on the material of the sensing object. Study the engineering data for the influence of sensing object material and size and select a distance with sufficient leeway.

- In general, if the sensing object is a non-magnetic metal (for example, aluminum), the sensing distance decreases.

Example: E2-X10D □

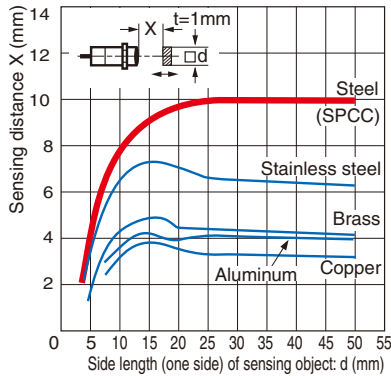

Size of Sensing Object

In general, if the object is smaller than the standard sensing object, the sensing distance decreases.

- Design the setup for an object size that is the same or greater than the standard sensing object size from the graphs showing the sensing object size and sensing distance.
- When the size of the standard sensing object is the same or less than the size of the standard sensing object, select a sensing distance with sufficient leeway.

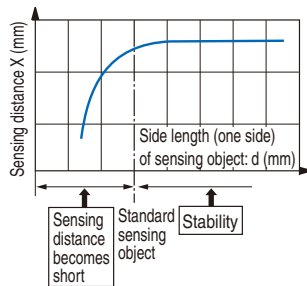

Thickness of Sensing Object

- The thickness of ferrous metals (iron, nickel, etc.) must be 1 mm or greater.
- When the coating thickness is 0.01 mm or less, a sensing distance equivalent to a magnetic body can be obtained. When the coating is extremely thin and is not conductive, such as a vacuum deposited film, detection is not possible.

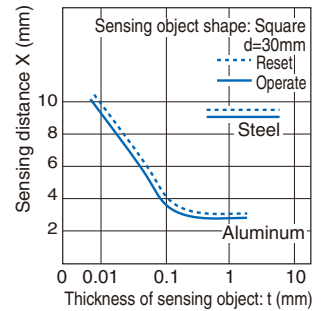

- Influence of Plating If the sensing object is plated, the sensing distance will change (see the table below).

Effect of Plating (Typical)

(Reference values: Percent of non-plated sensing distance)

Thickness and base material of plating	Steel	Brass
No plating	100	100
Zn 5 to 15 μm	90 to 120	95 to 105
Cd 5 to 15 μm	100 to 110	95 to 105
Ag 5 to 15 μm	60 to 90	85 to 100
Cu 10 to 20 μm	70 to 95	95 to 105
Cu 5 to 15 μm	-	95 to 105
Cu (5 to 10 μm) + Ni (10 to 20 μm)	70 to 95	-
Cu (5 to 10 μm) + Ni (10 μm) + Cr (0.3 μm)	75 to 95	-

Mutual Interference

- Mutual interference refers to a state where a Sensor is affected by magnetism (or static capacitance) from an adjacent Sensor and the output is unstable.
- One means of avoiding interference when mounting Proximity Sensors close together is to alternate Sensors with different frequencies. The model tables indicate whether different frequencies are available. Please refer to the tables.
- When Proximity Sensors with the same frequency are mounted together in a line or face-to-face, they must be separated by a minimum distance. For details, refer to *Mutual Interference* in the *Safety Precautions* for individual Sensors.

Power Reset Time

A Sensor is ready for detection within 100 ms after turning ON the power. If the load and Sensor are connected to separate power supplies, design the system so that the Sensor power turns ON first.

Proximity Sensors Technical Guide

Turning OFF the Power

An output pulse may be generated when the power is turned OFF, so design the system so that the load or load line power turns OFF first.

Influence of Surrounding Metal

The existence of a metal object other than the sensing object near the sensing surface of the Proximity Sensor will affect detection performance, increase the apparent operating distance, degrade temperature characteristics, and cause reset failures. For details, refer to the influence of surrounding metal table in *Safety Precautions* for individual Sensors.

The values in the table are for the nuts provided with the Sensors. Changing the nut material will change the influence of the surrounding metal.

Power Transformers

Be sure to use an insulated transformer for a DC power supply. Do not use an auto-transformer (single-coil transformer).

Precautions for AC 2-Wire/DC 2-Wire Sensors

Surge Protection

Although the Proximity Sensor has a surge absorption circuit, if there is a device (motor, welder, etc.) that causes large surges near the Proximity Sensor, insert a surge absorber near the source of the surges.

Influence of Leakage Current

Even when the Proximity Sensor is OFF, a small amount of current runs through the circuit as leakage current.

For this reason, a small current may remain in the load (residual voltage in the load) and cause load reset failures. Verify that this voltage is lower than the load reset voltage (the leakage current is less than the load reset current) before using the Sensor.

Using an Electronic Device as the Load for an AC 2-Wire Sensor

When using an electronic device, such as a Timer, some types of devices use AC half-wave rectification. When a Proximity Sensor is connected to a device using AC half-wave rectification, only AC half-wave power will be supplied to the Sensor. This will cause the Sensor operation to be unstable. Also, do not use a Proximity Sensor to turn the power supply ON and OFF for electronic devices that use DC half-wave rectification. In such a case, use a relay to turn the power supply ON and OFF, and check the system for operating stability after connecting it.

Examples of Timers that Use AC Half-wave Rectification

Timers: H3Y, H3YN, H3RN, H3CA-8, RD2P, and H3CR (-A, -A8, -AP, -F, -G)

Countermeasures for Leakage Current (Examples)

AC 2-Wire Sensors

Connect a bleeder resistor to bypass the leakage current flowing in the load so that the current flowing through the load is less than the load reset current.

When using an AC 2-Wire Sensor, connect a bleeder resistor so that the Proximity Sensor current is at least 10 mA, and the residual load voltage when the Proximity Sensor is OFF is less than the load reset voltage.

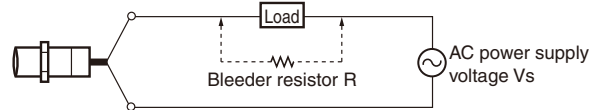

Calculate the bleeder resistance and allowable power using the following equation.

$$R \leq \frac{V_s}{10 - I} \text{ (k}\Omega\text{)} \quad P > \frac{V_s^2}{R} \text{ (mW)}$$

P : Watts of bleeder resistance (the actual number of watts used should be several times this number)

I : Load current (mA)

It is recommended that leeway be included in the actual values used. For 100 VAC, use 10 k Ω or less and 3 W (5 W) or higher, and for 200 VAC, use 20 k Ω or less and 10 W (20 W) or higher. If the effects of heat generation are a problem, use the number of watts in parentheses () or higher.

DC 2-Wire Sensors

Connect a bleeder resistor to bypass the leakage current flowing in the load, and design the load current so that (leakage current) \times (load input impedance) < reset voltage.

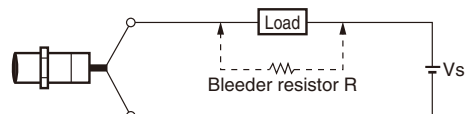

Calculate the bleeder resistance and allowable power using the following equation.

$$R \leq \frac{V_s}{i_R - i_{OFFR}} \text{ (k}\Omega\text{)} \quad P > \frac{V_s^2}{R} \text{ (mW)}$$

P : Watts of bleeder resistance (the actual number of watts used should be several times this number)

i_R : Leakage current of Proximity Sensor (mA)

i_{OFFR} : Load reset current (mA)

It is recommended that leeway be included in the actual values used. For 12 VDC, use 15 k Ω or less and 450 mW or higher, and for 24 VDC, use 30 k Ω or less and 0.1 W or higher.

Loads with Large Inrush Current

Loads, such as lamps or motors, that cause a large inrush current* will weaken or damage the switching element. In this situation, use a relay.

* E2K, TL-N□Y: 1 A or higher

●Mounting

Mounting the Sensor

When mounting a Sensor, do not tap it with a hammer or otherwise subject it to excessive shock. This will weaken water resistance and may damage the Sensor. If the Sensor is being secured with bolts, observe the allowable tightening torque. Some models require the use of toothed washers.

For details, refer to the mounting precautions in *Precautions for Correct Use* in individual product information.

Mounting/Removing Using DIN Track

(Example for E2CY)

<Mounting>

- (1) Insert the front of the Sensor into the special Mounting Bracket (included) or DIN Track.
- (2) Press the rear of the Sensor into the special Mounting Bracket or DIN Track.

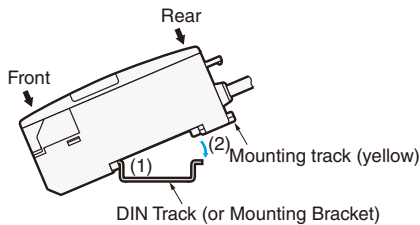

- When mounting the side of the Sensor using the special Mounting Bracket, first secure the Amplifier Unit to the special Mounting Bracket, and then mount the special Mounting Bracket with M3 screws and flat washers with a diameter of 6 mm maximum.

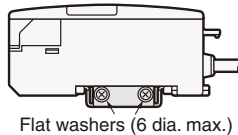

<Removing>

- While pressing the Amplifier Unit in the direction of (3), lift the fiber plug in the direction of (4) for easy removal without a screwdriver.

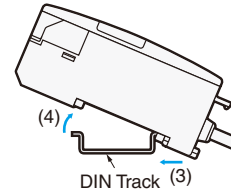

Set Distance

The sensing distance may vary due to fluctuations in temperature and voltage. When mounting the Sensor, it is recommended that installation be based on the set distance.

Proximity Sensors Technical Guide

●Wiring Considerations

AND/OR Connections for Proximity Sensors

Model	Type of connection	Connection	Description
DC 2-Wire	AND (series connection)		<p>Keep the number of connected Sensors (N) within the range of the following equation.</p> $V_S - N \times V_R \geq \text{Operating load voltage}$ <p> N: Number of Sensors that can be connected V_R: Residual output voltage of Proximity Sensor V_S: Power voltage </p> <p>It is possible, however, that the indicators may not light correctly and error pulses (of approximately 1 ms) may be generated because the rated power supply voltage and current are not supplied to individual Proximity Sensors. Verify that this is not a problem before operation.</p>
	OR (parallel connection)		<p>Keep the number of connected Sensors (N) within the range of the following equation.</p> $N \times i \leq \text{Load reset current}$ <p> N: Number of Sensors that can be connected i: Leakage current of Proximity Sensor </p> <p>Example: When an MY (24-VDC) Relay is used as the load, the maximum number of Sensors that can be connected is 4.</p>
AC 2-wire	AND (series connection)		<p><TL-NY, TL-MY, E2K-□MY□, TL-T□Y></p> <p>The above Proximity Sensors cannot be used in a series connection. If needed, connect through relays.</p>
			<p><E2E-X□Y></p> <p>For the above Proximity Sensors, the voltage V_L that can be applied to the load when ON is $V_L = V_S - (\text{Output residual voltage} \times \text{Number of Sensors})$, for both 100 VAC and 200 VAC. The load will not operate unless V_L is higher than the load operating voltage. This must be verified before use. When using two or more Sensors in series with an AND circuit, the limit is three Sensors. (Be careful of the V_S value in the diagram at left.)</p>
	OR (parallel connection)		<p>In general it is not possible to use two or more Proximity Sensors in parallel with an OR circuit.</p> <p>A parallel connection can be used if A and B will not be operated simultaneously and there is no need to hold the load. The leakage current, however, will be n times the value for each Sensor and reset failures will frequently occur. ("n" is the number of Proximity Sensors.)</p> <p>If A and B will be operated simultaneously and the load is held, a parallel connection is not possible. If A and B operate simultaneously and the load is held, the voltages of both A and B will fall to about 10 V when A turns ON, and the load current will flow through A causing random operation. When the sensing object approaches B, the voltage of both terminals of B is too low at 10 V and the switching element of B will not operate. When A turns OFF again, the voltages of both A and B rise to the power supply voltage and B is finally able to turn ON.</p> <p>During this period, there are times when A and B both turn OFF (approximately 10 ms) and the loads are momentarily restored. In cases where the load is to be held in this way, use a relay as shown in the diagram at left.</p>

Note: When AND/OR connections are used with Proximity Sensors, the effects of erroneous pulses or leakage current may prevent use. Verify that there are no problems before use.

Proximity Sensors Technical Guide

Model	Type of connection	Connection	Description
DC 3-wire	AND (series connection)		<p>Keep the number of connected Sensors (N) within the range of the following equation.</p> $i_L + (N - 1) \times i \leq \text{Upper limit of Proximity Sensor control output}$ $V_s - N \times V_R \geq \text{Operating load voltage}$ <p> N: Number of Sensors that can be connected V_R: Residual output voltage of Sensor V_s: Power supply voltage i: Current consumption of Sensor i_L: Load current </p> <p>Note: When an AND circuit is connected, the operation of Proximity Sensor B causes power to be supplied to Proximity Sensor A, and thus erroneous pulses (approximately 1 ms) may be generated in A when the power is turned ON. For this reason, take care when the load has a high response speed because malfunction may result.</p>
	OR (parallel connection)		<p>For Sensors with a current output, a minimum of three OR connections is possible. Whether or not four or more connections is possible depends on the model.</p>

Note: When AND/OR connections are used with Proximity Sensors, the effects of erroneous pulses or leakage current may prevent use. Verify that there are no problems before use.

Extending Cable Length

The cable of a Built-in Amplifier Sensor can be extended to a maximum length of 200 m with each of the standard cables (excluding some models).

For Separate Amplifier Sensors (E2C-EDA, E2C, E2J, E2CY), refer to the specific precautions for individual products.

Bending the Cable

If you need to bend the cable, we recommend a bend radius that is at least 3 times the outer diameter of the cable (with the exception of coaxial and shielded cables).

Cable Tensile Strength

In general, do not subject the cable to a tension greater than that indicated in the following table.

Cable diameter	Tensile strength
Less than 4 mm	30 N max.
4 mm min.	50 N max.

Note: Do not subject a shielded cable or coaxial cable to tension.

Separating High-voltage Lines

Using Metal Conduits

If a power line is to be located near the Proximity Sensor cable, use a separate metal conduit to prevent malfunction or damage. (Same for DC models.)

Example of Connection with S3D2 Sensor Controller

DC 2-Wire Sensors

Using the S3D2 Sensor Controller

Operation can be reversed with the signal input switch on the S3D2.

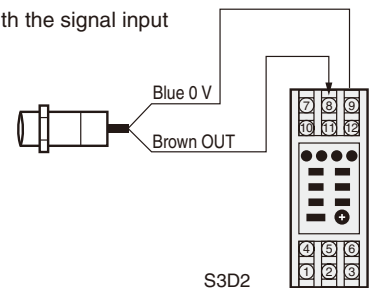

Connecting to a Relay Load

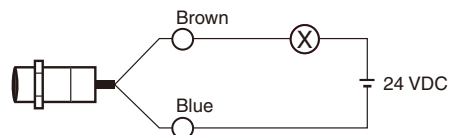

Note: DC 2-Wire Sensors have a residual voltage of 3 V. Check the operating voltage of the relay before use.

The residual voltage of the E2E-XD-M1J-T is 5 V.

DC 3-Wire Sensors

Operation can be reversed with the signal input switch on the S3D2.

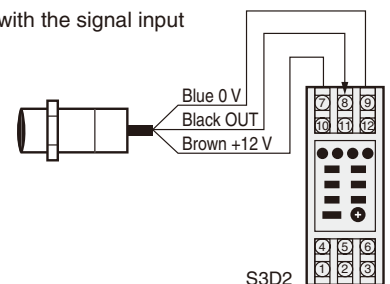

●Operating Environment

Water Resistance

Do not use the Sensor in water, rain, or outdoors.

Ambient Conditions

Do not use the Sensor in the following environments.

Doing so may cause malfunction or failure of the Sensor.

1. To maintain operational reliability and service life, use the Sensor only within the specified temperature range and do not use it outdoors.
2. The Sensor has a water resistant structure, however, attaching a cover to prevent direct contact with water will help improve reliability and prolong product life.
3. Avoid using the Sensor where there are chemical vapors, especially strong alkalis or acids (nitric acid, chromic acid, or hot concentrated sulfuric acid).

●Maintenance and inspection

Periodic Inspection

To ensure long-term stable operation of the Proximity Sensor, inspect for the following on a regular basis. Conduct these inspections also for control devices.

1. Shifting, loosening, or deformation of the sensing object and Proximity Sensor mounting
2. Loosening, bad contact, or wire breakage in the wiring and connections
3. Adherence or accumulation of metal powder
4. Abnormal operating temperature or ambient conditions
5. Abnormal indicator flashing (on setting indicator types)

Disassembly and Repair

Do not under any circumstances attempt to disassemble or repair the product.

Quick Failure Check

You can conveniently check for failures by connecting the E39-VA Handy Checker to check the operation of the Sensor.

Read and Understand This Catalog

Please read and understand this catalog before purchasing the products. Please consult your OMRON representative if you have any questions or comments.

Warranty and Limitations of Liability

WARRANTY

OMRON's exclusive warranty is that the products are free from defects in materials and workmanship for a period of one year (or other period if specified) from date of sale by OMRON.

OMRON MAKES NO WARRANTY OR REPRESENTATION, EXPRESS OR IMPLIED, REGARDING NON-INFRINGEMENT, MERCHANTABILITY, OR FITNESS FOR PARTICULAR PURPOSE OF THE PRODUCTS. ANY BUYER OR USER ACKNOWLEDGES THAT THE BUYER OR USER ALONE HAS DETERMINED THAT THE PRODUCTS WILL SUITABLY MEET THE REQUIREMENTS OF THEIR INTENDED USE. OMRON DISCLAIMS ALL OTHER WARRANTIES, EXPRESS OR IMPLIED.

LIMITATIONS OF LIABILITY

OMRON SHALL NOT BE RESPONSIBLE FOR SPECIAL, INDIRECT, OR CONSEQUENTIAL DAMAGES, LOSS OF PROFITS, OR COMMERCIAL LOSS IN ANY WAY CONNECTED WITH THE PRODUCTS, WHETHER SUCH CLAIM IS BASED ON CONTRACT, WARRANTY, NEGLIGENCE, OR STRICT LIABILITY.

In no event shall responsibility of OMRON for any act exceed the individual price of the product on which liability is asserted.

IN NO EVENT SHALL OMRON BE RESPONSIBLE FOR WARRANTY, REPAIR, OR OTHER CLAIMS REGARDING THE PRODUCTS UNLESS OMRON'S ANALYSIS CONFIRMS THAT THE PRODUCTS WERE PROPERLY HANDLED, STORED, INSTALLED, AND MAINTAINED AND NOT SUBJECT TO CONTAMINATION, ABUSE, MISUSE, OR INAPPROPRIATE MODIFICATION OR REPAIR.

Application Considerations

SUITABILITY FOR USE

OMRON shall not be responsible for conformity with any standards, codes, or regulations that apply to the combination of products in the customer's application or use of the product.

At the customer's request, OMRON will provide applicable third party certification documents identifying ratings and limitations of use that apply to the products. This information by itself is not sufficient for a complete determination of the suitability of the products in combination with the end product, machine, system, or other application or use.

The following are some examples of applications for which particular attention must be given. This is not intended to be an exhaustive list of all possible uses of the products, nor is it intended to imply that the uses listed may be suitable for the products:

- Outdoor use, uses involving potential chemical contamination or electrical interference, or conditions or uses not described in this catalog.
- Nuclear energy control systems, combustion systems, railroad systems, aviation systems, medical equipment, amusement machines, vehicles, safety equipment, and installations subject to separate industry or government regulations.
- Systems, machines, and equipment that could present a risk to life or property.

Please know and observe all prohibitions of use applicable to the products.

NEVER USE THE PRODUCTS FOR AN APPLICATION INVOLVING SERIOUS RISK TO LIFE OR PROPERTY WITHOUT ENSURING THAT THE SYSTEM AS A WHOLE HAS BEEN DESIGNED TO ADDRESS THE RISKS, AND THAT THE OMRON PRODUCT IS PROPERLY RATED AND INSTALLED FOR THE INTENDED USE WITHIN THE OVERALL EQUIPMENT OR SYSTEM.

Disclaimers

CHANGE IN SPECIFICATIONS

Product specifications and accessories may be changed at any time based on improvements and other reasons.

It is our practice to change model numbers when published ratings or features are changed, or when significant construction changes are made. However, some specifications of the product may be changed without any notice. When in doubt, special model numbers may be assigned to fix or establish key specifications for your application on your request. Please consult with your OMRON representative at any time to confirm actual specifications of purchased product.

DIMENSIONS AND WEIGHTS

Dimensions and weights are nominal and are not to be used for manufacturing purposes, even when tolerances are shown.

ERRORS AND OMISSIONS

The information in this catalog has been carefully checked and is believed to be accurate; however, no responsibility is assumed for clerical, typographical, or proofreading errors, or omissions.

PERFORMANCE DATA

Performance data given in this catalog is provided as a guide for the user in determining suitability and does not constitute a warranty. It may represent the result of OMRON's test conditions, and the users must correlate it to actual application requirements. Actual performance is subject to the OMRON Warranty and Limitations of Liability.

PROGRAMMABLE PRODUCTS

OMRON shall not be responsible for the user's programming of a programmable product, or any consequence thereof.

COPYRIGHT AND COPY PERMISSION

This catalog shall not be copied for sales or promotions without permission.

This catalog is protected by copyright and is intended solely for use in conjunction with the product. Please notify us before copying or reproducing this catalog in any manner, for any other purpose. If copying or transmitting this catalog to another, please copy or transmit it in its entirety.