

## FLP0412FPx Open Frame Power Supply

90 - 265Vac input; 2-4 outputs; 450W Output Power



### Applications

- Industrial equipment
- Telecommunications equipment

### Description

In a small 3 x 7 inch footprint, the 450W 2-4 output FLP0412x open frame power supply delivers greater than 90 percent typical power efficiency and full load output at 42°C and 1m/s airflow. Protection features include output overcurrent (OCP), overvoltage (OVP), and overtemperature (OTP). There is power trading between the outputs. Whatever power is going to be taken from V2, V3, and V4, should be deducted from the gross power available from V1. This unit also offers PMBus control and monitoring of V3 and V4. Use of this feature is optional.

### Features

- Compact size 76.2 mm x 178 mm x 36.8 mm (3 in x 7 in x 1.45 in) with density of 15 W/in<sup>3</sup>
- Universal AC Input Range (90 – 265VAC)
- Output voltages of +12V (adjustable ±5%), +24V (adjustable 16-34V), +5V (adjustable 1-5.5V), +3.3V (adjustable 1-5.5V)
- Standby output of 5V @ 1A
- Maximum output current of 37.5A12V, 2A24V, 12A5V, 12A3.3V (450W total, see description below)
- High efficiency (>91% at Full Load, 230VAC in)
- Full load capability at 42°C and 1m/s airflow with derating at higher temperatures or lower airflows
- Capable of 320W out in sealed enclosure applications with enclosure ambient at 55°C
- Output overcurrent protection (non-latching)
- Overtemperature protection
- Output overvoltage protection
- Minimum of 11ms of holdup time at 450W out
- Parallelable with output current sharing on main 12V output – option, please request details
- Active power factor corrected input
- Conducted EMI - meets CISPR22 (EN55022/EN55032) and FCC Class B requirements
- Meets IEC61000-4-5, Level 4 (2kV/4kV)
- Compliant to RoHS EU Directive 2002/95/EC
- UL and cUL approved to UL/CSA60950-1, TUV (EN60950-1), CE Mark (for LVD) and CB Report available
- ISO\*\* 9001 and ISO 14001 certified manufacturing facilities

\* UL is a registered trademark of Underwriters Laboratories, Inc.

† CSA is a registered trademark of Canadian Standards Association.

‡ VDE is a trademark of Verband Deutscher Elektrotechniker e.V.

\*\* ISO is a registered trademark of the International Organization of Standards

## FLP0412FPx Open Frame Power Supply

### 90 - 265Vac input; 2-4 outputs; 450W Output Power

#### Absolute Maximum Ratings

Stresses in excess of the absolute maximum ratings can cause permanent damage to the device. These are absolute stress ratings only, functional operation of the device is not implied at these or any other conditions in excess of those given in the operations sections of the data sheet. Exposure to absolute maximum ratings for extended periods can adversely affect the device reliability.

Parameter	Device	Min	Max	Unit
Input Voltage - Continuous	All	90	265	Vac
For up to 10 seconds	All	90	275	Vac
Operating Ambient Temperature (see Thermal Considerations section)	All	-40	85	°C
Storage Temperature	All	-40	85	°C
Humidity (non-condensing)	All	5	95	%
Altitude	All		5000	m
Isolation Voltage – Input to output	All		3000	Vac
Input to safety ground	All		1500	Vac
Outputs to safety ground	All		50	Vac

#### Electrical Specifications

Parameter	Device	Min	Typ	Max	Unit
Operating Input Voltage	All	90	115/230	265	Vac
Input Source Frequency	All	47	50/60	63	Hz
Input Current ( $V_{IN} = 90\text{Vac}$ )	All			6	A <sub>RMS</sub>
Input Power Factor (230Vac, Full Load)	All	0.95			
Inrush Transient Current ( $V_{IN} = 265\text{Vac}$ , $T_{amb} = 25^{\circ}\text{C}$ )	All			60	A Peak
Leakage Current to earth ground ( $V_{IN} = 265\text{Vac}$ )	All			3.5	mA
V1 Output Voltage Setpoint	All		12		Vdc
V1 Output Voltage Tolerance (due to set point, temperature variations, load and line regulation)	All	-2		2	%
V1 Output Voltage Adjustment Range	All	11.4		12.6	Vdc
V1 Output Remote Sense Range	All			250	mVdc
V1 Output Load Regulation	All			1	%Vout
V1 Output Line Regulation	All			0.5	%Vout
V1 Output Ripple and Noise – measured with 0.1 $\mu\text{F}$ ceramic capacitor in parallel with 470 $\mu\text{F}$ electrolytic capacitor Peak-to-peak (20MHz Bandwidth)	All			240	mV p-p
V1 Dynamic Load Response – 50% to 100% transient, 1A/ $\mu\text{s}$ slew rate Output voltage deviation Settling Time	All All			5% 500	% $\mu\text{s}$
V1 Output Current gross – see page 1	All	0		37.5	Adc
V1 Output Current Limit Inception	All	105		145	% $I_{O,max}$
V1 Maximum Output Capacitance	All			10000	$\mu\text{F}$
Standby Output Voltage	All		5		Vdc
Standby Output Current	All			1	Adc
Efficiency: $V_{IN} = 230\text{Vac}$ , 20% load	All		84.5		%
50% load	All		91.3		%
100% load	All		91.9		%
$V_{IN} = 115\text{Vac}$ , 20% load	All		83.5		%
50% load	All		89.9		%
100% load	All		90		%
Holdup Time <sup>1</sup> – $V_{IN} = 115\text{Vac}$ , 450W load	All	11			ms
$V_{IN} = 230\text{Vac}$ , 450W load	All	11			ms

<sup>1</sup> Holdup time may be lower at cold temperatures

## FLP0412FPx Open Frame Power Supply

90 - 265Vac input; 2-4 outputs; 450W Output Power

### General Specifications

Parameter	Device	Symbol	Typ.	Unit
Calculated Reliability based on Telcordia SR-332 Issue 3: Method 1 Case 3 ( $V_{IN}=230V_{AC}$ , $I_o = 30A$ , $T_A = 40^{\circ}C$ , airflow 200LFM, 90% confidence)	All	MTBF	>650,000	Hours
Weight	All		420 15	g oz.

### Feature Specifications

Parameter	Device	Min	Typ	Max	Unit
On/Off Signal Interface – signal referenced to GND					
Logic Low (Power Supply ON)					
Input Low Current	All			7	mA
Input Low Voltage	All			1	V
Logic High (Power Supply OFF)					
Input High Current	All			600	$\mu A$
Input Voltage	All			5.5	V
Delay from ON/OFF being enabled to start of output voltage rise	All			50	ms
Output Voltage Rise Time (from 10 to 90% of final value)	All		20		ms
Delay from Input being applied to all outputs being in regulation	All			1	s
V1 Output Overvoltage Protection	All	13.8		16	Vdc
Input Undervoltage lockout <sup>2</sup>					
Turn-on Threshold (100% load)	All	85	87.6	90	Vac
Turn-off Threshold (100% load)	All	82	83.9	88	Vac
V1 DC OK – open collector, High when output available					
Sink Current	All			4	mA
Maximum Collector Voltage	All			12	V

<sup>2</sup> Undervoltage lockout threshold may vary with output load current level – decreasing as load goes lower

## FLP0412FPx Open Frame Power Supply

90 - 265Vac input; 2-4 outputs; 450W Output Power

### Environmental Specifications

Parameter	Device	Specification/Test
Radiated Emissions <sup>3</sup>	All	CISPR22/32 Class B with 3dB margin
Conducted Emissions	All	CISPR22/32 Class B with 6dB margin
ESD	All	IEC61000-4-2, Level 4, performance criterion A
Radiated Susceptibility <sup>4</sup>	All	IEC61000-4-3, Level 3
Electrical Fast Transient Common Mode	All	IEC61000-4-4, Level 3
Surge Immunity	All	IEC61000-4-5, Level 4
Conducted RF Immunity	All	IEC61000-4-6, Level 3
Input Voltage Dips	All	Output stays within regulation for either ½ cycle interruption or 25% dip from nominal line for 1 second
Input Harmonics	All	IEC61000-3-2
Shock and Vibration	All	Per IPC-9592B, Class II

### Safety Specifications

Parameter	Device	Specification
Dielectric Withstand Voltage (between input and outputs)	All	Minimum of 4,250Vdc for 1 minute
Insulation Resistance (between input and outputs)	All	Minimum of 5 MΩ
Safety Standards	All	Class 1, IEC60950, EN60950, with the following deviations: Nemko, UL 60950 (Recognized Component), cUL (Canadian Approval by UL)

<sup>3</sup> Shall meet when tested in a suitable enclosure

<sup>4</sup> Shall meet when tested in a suitable enclosure

## FLP0412FPx Open Frame Power Supply

90 - 265Vac input; 2-4 outputs; 450W Output Power

### V2 +24V, 0-2A, provided by built-in ABXS002A3X41-SRZ

The output voltage can be adjusted by potentiometer RV2 over the range 16V to 34V.

V2 is provided by an ABXS002A3X41-SRZ which has around it the components required to ensure it meets the rest of this specification. V2+, V2powergood, and V2return are brought to the auxiliary output connector (HDR4).

V2 Turn-on happens when V1 reaches 91% of its nominal value. Turn-off happens when V1 goes below 86% or above 112% of its nominal value. V2 features the OTP, OCP, and OVP as provided by the converter.

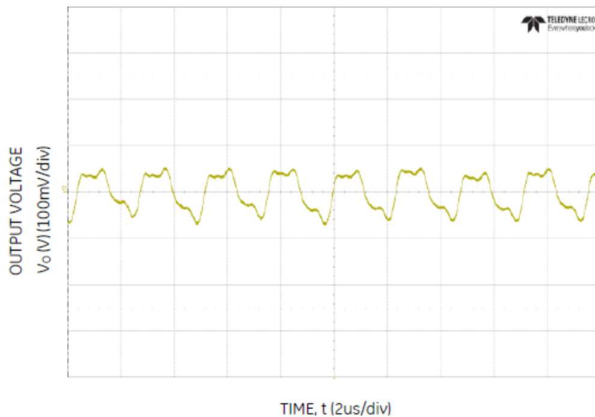

Figure 9. Typical output ripple and noise ( $C_o=66\mu\text{F}$  ceramic,  $V_{IN} = 12\text{V}$ ,  $I_o = I_{o,max}$ ).

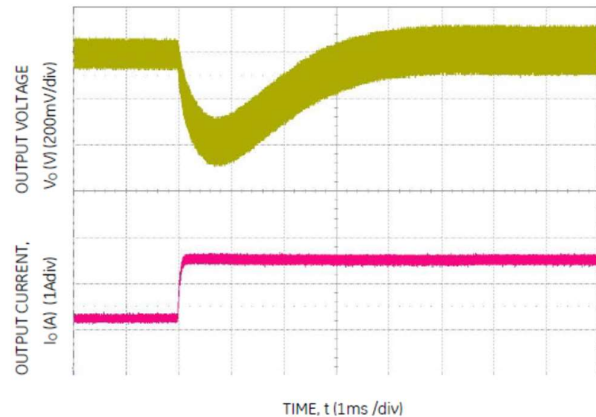

Figure 10. Transient Response to Dynamic Load Change from 50% to 100% at  $12\text{V}_{in}$ ,  $C_{out}=3\times 10\mu\text{F}+220\mu\text{F}$ ,  $C_{Tune}=3300\text{pF}$ ,  $R_{Tune}=30.1\text{k}\Omega$

### Overcurrent Protection

To provide protection in a fault (output overload) condition, the unit is equipped with internal current-limiting circuitry and can endure current limiting continuously. At the point of current-limit inception, the unit enters hiccup mode. The unit operates normally once the output current is brought back into its specified range.

### Power Good

The module provides a Power Good (PGOOD) signal that is implemented with an open-drain output to indicate that the output voltage is within the regulation limits of the power module. The PGOOD signal will be de-asserted to a low state if any condition such as overtemperature, overcurrent or loss of regulation occurs that would result in the output voltage going outside the specified thresholds. The PGOOD terminal can be connected through a pullup resistor (suggested value  $10\text{k}\Omega$ ) to a source of 5VDC or lower.

FLP0412FPx Open Frame Power Supply  
 90 - 265Vac input; 2-4 outputs; 450W Output Power

Schematic for V2

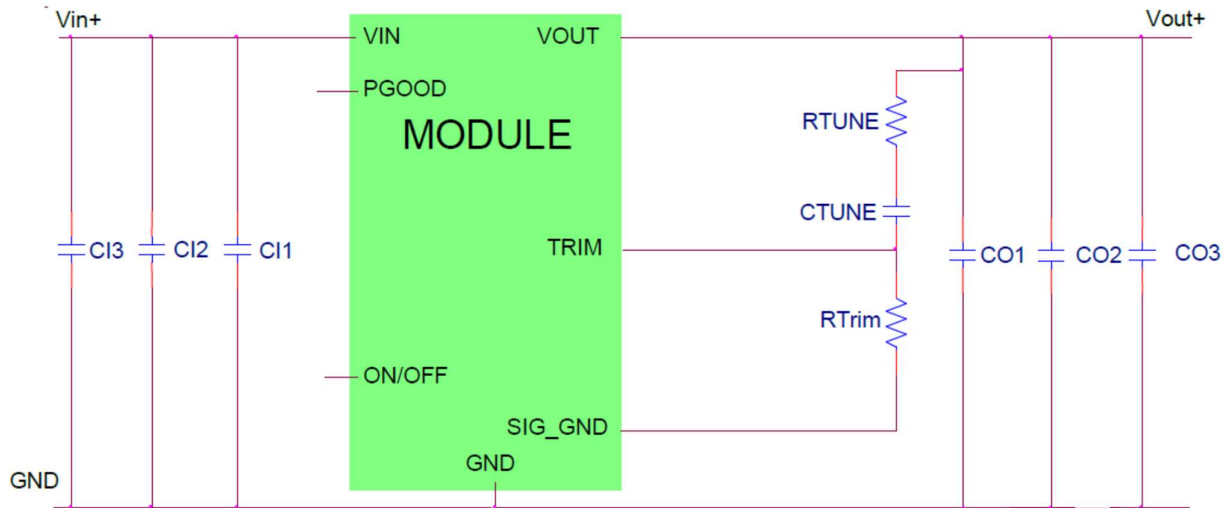

C11	1 x 0.047µF/50V, 0603 ceramic capacitor
C12	4 x 10µF/50V, 1210 ceramic capacitor
C13	1 x 220µF/25V, bulk electrolytic
CO1	1 x 0.01µF/100V, 0805 ceramic capacitor
CO2	9 x 4.7µF/100V, 1210 ceramic capacitor
CO3	1 x 220µF/100V, bulk electrolytic
CTune	220pF ceramic capacitor (can be 1206, 0805 or 0603 size)
RTune	40.2 kΩSMT resistor (can be 1206, 0805 or 0603 size)

The output voltage is able to be adjusted by potentiometer RV2 over the range 16V to 34V, and this replaces the Rtrim shown above.

## FLP0412FPx Open Frame Power Supply

90 - 265Vac input; 2-4 outputs; 450W Output Power

### V3 and V4 +5V (default) and +3.3V (default), 0-12A, provided by two built-in PDT012

The output voltages are adjusted by potentiometers RV3 and RV4 over the range 1V to 5.5V.

V3 and V4 are provided by a PDT012 which have around them the components required to ensure they meet the rest of this specification. V3/4+, V3/4sense+, V3/4powergood, and V3/4return are brought to the auxiliary output connector (HDR4). Clock, Data, SMB Alert#, and 0V are brought to the PMBus connector (HDR5).

All of the digital features are the same as the PDT012 data sheet. For detailed digital interface specifications and feature descriptions, refer to PDT012 datasheet.

V3 and V4 Turn-on happens when V1 reaches 91% of its nominal value. Turn-off happens when V1 goes below 86% or above 112% of its nominal value. V3 and V4 feature the OTP, OCP, and OVP as provided by the converters, and as modified by the customer using PMBus.

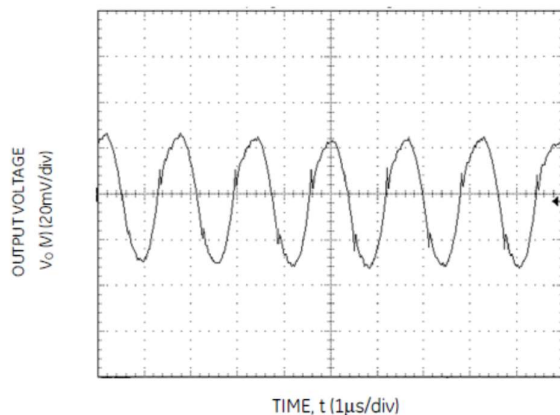

Figure 33. Typical output ripple and noise ( $C_o=22\mu\text{F}$  ceramic,  $V_{IN} = 12\text{V}$ ,  $I_o = I_{o,max}$ ).

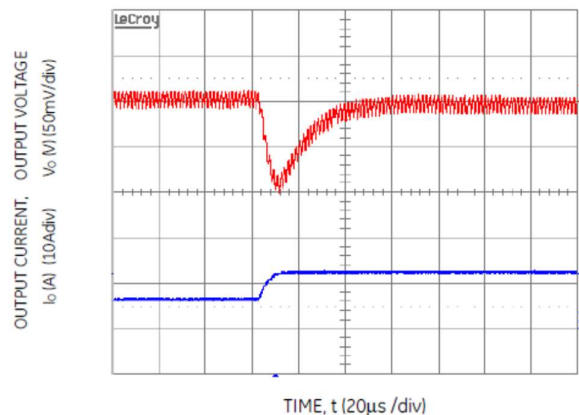

Figure 34. Transient Response to Dynamic Load Change from 50% to 100% at 12Vin,  $C_{out}=5x47\mu\text{F}$ ,  $C_{Tune}=1500\text{pF}$  &  $R_{Tune}=330\text{ohms}$

### Overcurrent Protection

To provide protection in a fault (output overload) condition, the unit is equipped with internal current-limiting circuitry and can endure current limiting continuously. At the point of current-limit inception, the unit enters hiccup mode. The unit operates normally once the output current is brought back into its specified range.

### Power Good

The module provides a Power Good (PGOOD) signal that is implemented with an open-drain output to indicate that the output voltage is within the regulation limits of the power module. The PGOOD signal will be de-asserted to a low state if any condition such as overtemperature, overcurrent or loss of regulation occurs that would result in the output voltage going  $\pm 10\%$  outside the setpoint value. The PGOOD terminal can be connected through a pullup resistor (suggested value  $100\text{K}\Omega$ ) to a source of 5VDC or lower.



# FLP0412FPx Open Frame Power Supply

90 - 265Vac input; 2-4 outputs; 450W Output Power

## Schematic for V3 and V4 +5V (default) and +3.3V (default), 0-12A

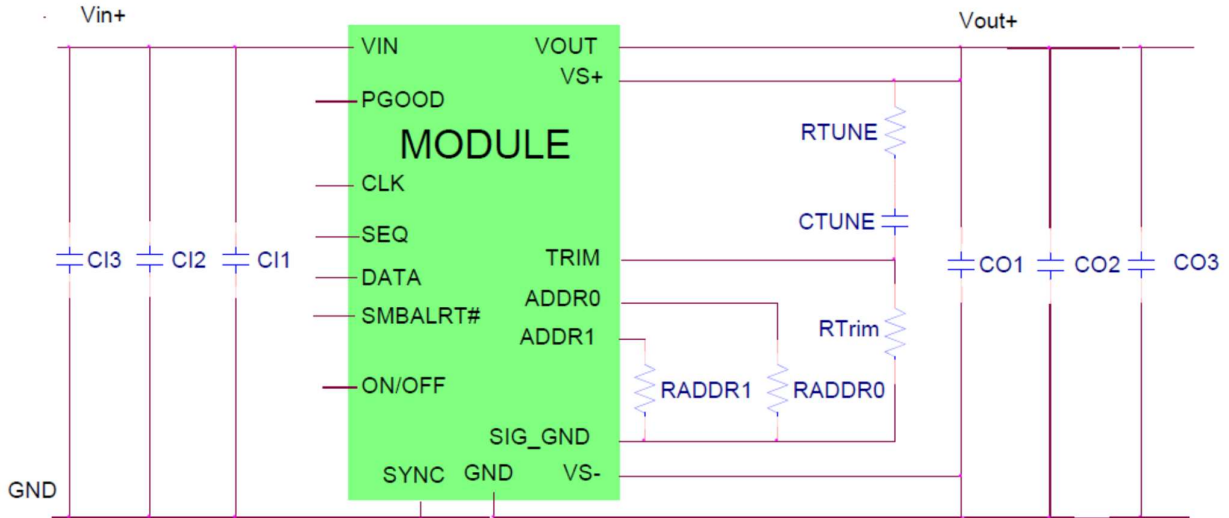

- CI1            Decoupling cap - 1x0.047 $\mu$ F/16V ceramic capacitor (e.g. Murata LLL185R71C473MA01)
- CI2            2x22 $\mu$ F/16V ceramic capacitor (e.g. Murata GRM32ER61C226KE20)
- CI3            470 $\mu$ F/16V bulk electrolytic
- CO1            Decoupling cap - 1x0.047 $\mu$ F/16V ceramic capacitor (e.g. Murata LLL185R71C473MA01)
- CO2            2 x 47 $\mu$ F/6.3V ceramic capacitor (e.g. Murata GRM31CR60J476ME19)
- CO3            1 x 330 $\mu$ F/6.3V Polymer (e.g. Sanyo Poscap)
- CTune        3300pF ceramic capacitor (can be 1206, 0805 or 0603 size)
- RTune        270 ohms SMT resistor (can be 1206, 0805 or 0603 size)

The output voltages are adjusted by potentiometers RV3 and RV4 over the range 1V to 5.5V. These potentiometers replace the fixed Rtrim shown above.



**FLP0412FPx Open Frame Power Supply**  
**90 - 265Vac input; 2-4 outputs; 450W Output Power**

PGOOD (Power Good)						
Signal Interface Open Drain, $V_{supply} \leq 5VDC$						
Overvoltage threshold for PGOOD ON	All			108		$\%V_{o, set}$
Overvoltage threshold for PGOOD OFF	All			110		$\%V_{o, set}$
Undervoltage threshold for PGOOD ON	All			92		$\%V_{o, set}$
Undervoltage threshold for PGOOD OFF	All			90		$\%V_{o, set}$
Pulldown resistance of PGOOD pin	All				50	$\Omega$
Sink current capability into PGOOD pin	All				5	mA

## FLP0412x Open Frame Power Supply

### 90 - 265Vac input; 2-4 outputs; 450W Output Power

#### Safety Considerations

The FLP0412FPx power supply is intended for inclusion in other equipment and the installer must ensure that it is in compliance with all the requirements of the end application. This product is only for inclusion by professional installers within other equipment and must not be operated as a stand-alone product. The power supply should meet Class 1, IEC60950, EN60950, with the following deviations: Nemko. UL 60950 (Recognized Component) C-UL (Canadian Approval by UL).

#### Feature Descriptions

##### Standby Power Supply

A standby output of 5V in the FLP0412FPx power supply, comes on when AC input in the operating range is applied.

##### Remote On/Off

The FLP0412FPx power supply features a TTL-compatible On/Off control input. The power supply turns ON when the On/Off input goes low, and turns OFF when the input goes high. Note that if the On/Off pin is left unconnected, the power supply main output shall remain off.

##### V1 Output Voltage Adjustment

The V1 output voltage is adjusted between 11.4V and 12.6V using a potentiometer (RV1) on the power supply.

##### V1 Remote Sense

The power supply has both positive and negative remote sense connections that can be connected to the positive and negative rails of the main output near the load. The power supply operates without the remote sense connections being made.

##### V1 Overcurrent Protection

To provide protection in a fault condition (output overload), the power supply is equipped with internal current-limiting circuitry and can endure current limiting continuously. At the point of current-limit inception, the unit enters hiccup mode. The power supply operates normally once the output current is brought back into its specified range.

##### V1 Overvoltage Protection

Overvoltage protection is a feature of the FLP0412FPx power supply that protects both the load and the power supply from an output overvoltage condition. When an overvoltage occurs, the power supply shuts down and latches off until the overvoltage condition is removed. It is necessary to recycle the input to restart the power supply when this protection is activated.

##### Overtemperature Protection

The FLP0412FPx also features overtemperature protection in order to provide additional protection in a fault condition. The power supply is equipped with a thermal shutdown circuit which detects excessive internal temperatures and shuts the unit down. Once the power supply goes into overtemperature shutdown, it will cool before attempting to restart. The

overtemperature protection circuit will typically trigger when the unit is operated at 450W output with an ambient temperature of 53°C and 1m/s (200LFM) airflow.

##### Input Undervoltage Lockout

At input voltages below the input undervoltage lockout limit, power supply operation is disabled. The power supply begins to operate at an input voltage above the undervoltage lockout turn-on threshold

##### V1 DC OK

The FLP0412FPx provides a DC OK signal that indicates when the output has come up and is in regulation. This is an open-collector type signal that goes high when the output is available and within regulation.

##### V1 Power Good LED

A green LED on board the power supply illuminates when the main output voltage is above 10V.

##### Paralleling V1 with Active Output Current Sharing

This power supply has optional parallel operation with active V1 output current sharing. Paralleling is accomplished by connecting the Current Share signals of the power supplies together. At load current levels above 20%, the output currents of multiple power supplies will be within ±5% of the full load value. This feature is an option.

# FLP0412FPx Open Frame Power Supply

90 - 265Vac input; 2-4 outputs; 450W Output Power

## Thermal Considerations

The power supply can be operated in a variety of thermal environments, however sufficient cooling should be provided to ensure reliable operation.

Considerations include ambient temperature, airflow, power supply dissipation and the need for increased reliability. A reduction in the operating temperature of the power supply will result in increased reliability. The thermal data presented here is based on measurements taken during testing in a wind tunnel.

## Heat Transfer via Convection

Increased airflow through the power supply enhances the heat transfer via convection. Below figure shows the preferred airflow direction. Contact your GE technical representative for derating information in other airflow directions.

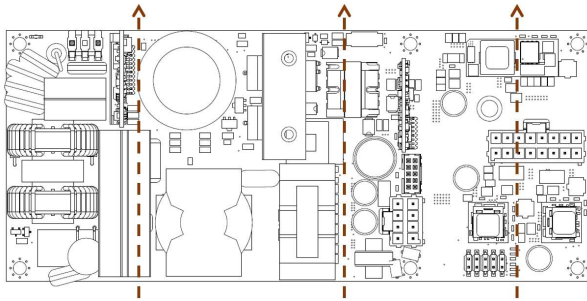

## Thermal Derating Characteristic Curve

Following curve data shown for model FLP0412FPMXXZ01A with 115Vac input. At 230Vac input derating is the same or better. For derating at other input voltages and other models, consult the GE Technical representative.

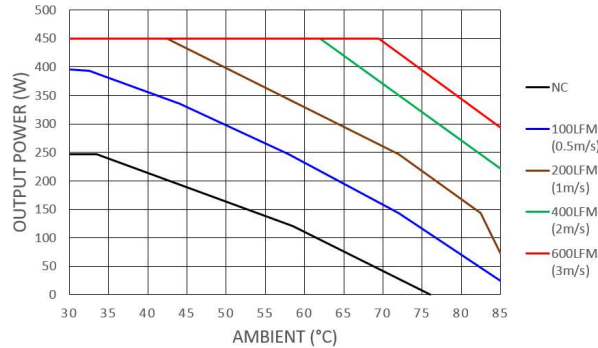

## Operation in a Sealed Enclosure

The FLP0412 power supply can also be operated in a sealed enclosure or in an environment where cooling is primarily via conduction. Bottom figure shows an arrangement where thermally conductive pads are used to transfer heat from the top and bottom of the power supply into the enclosure. Under such conditions, the power supply is capable of reduced power operation as shown in Table 1.

**Table 1. Output Power Capability when the FLP0412 is cooled primarily via conduction.**

Cold Wall Temperature (°C)	Max. Output Power (W)
25	420
55	320

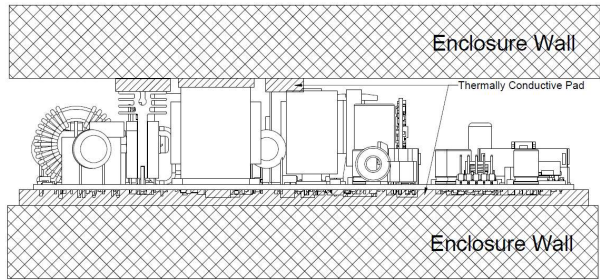
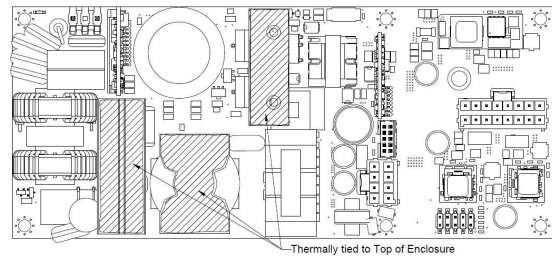

**Example arrangement of the FLP0412 for sealed enclosure applications.**

**FLP0412FPx Open Frame Power Supply**  
 90 - 265Vac input; 2-4 outputs; 450W Output Power

**Mechanical Outline**

TOP VIEW

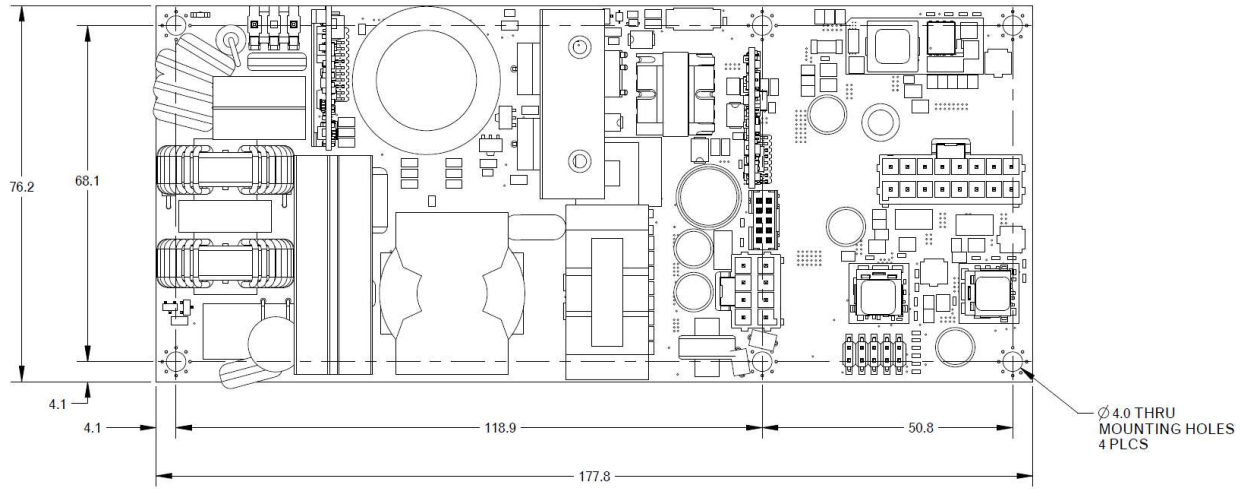

SIDE VIEW

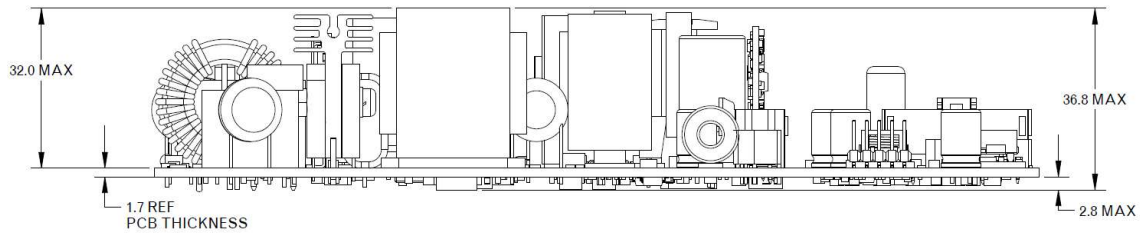

3D VIEW

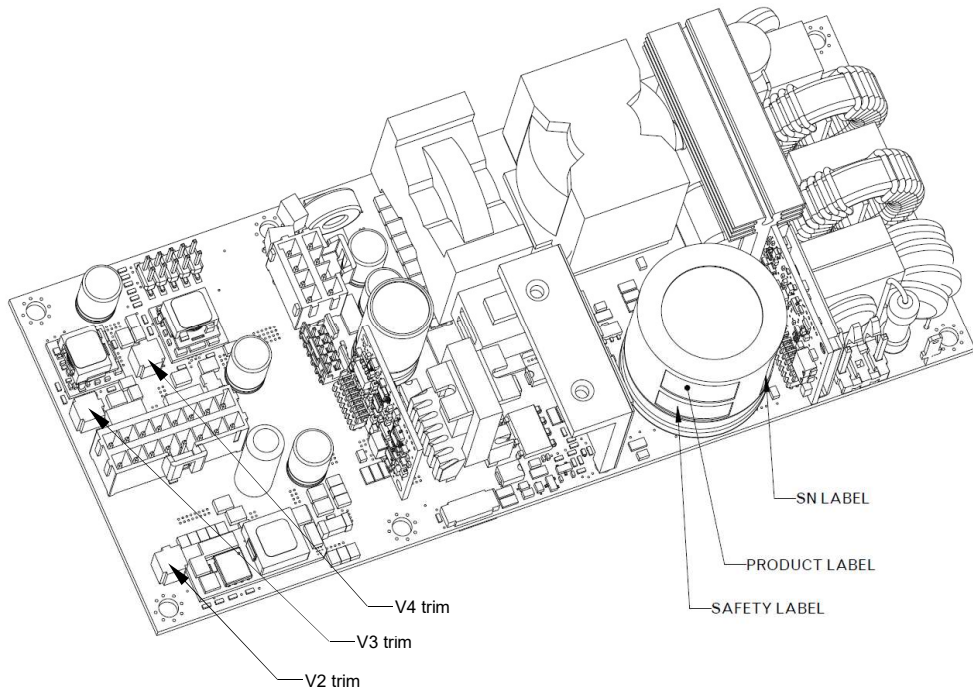

# FLP0412FPx Open Frame Power Supply

90 - 265Vac input; 2-4 outputs; 450W Output Power

## Connector Information

Connector	Connector on Power Supply	Mating Connector
AC Input Connector (HDR1)	Molex 41671-3437 or equivalent	Molex 09-50-3031 or equivalent
V1 DC Output Connector (HDR2)	Molex 172298-1208 or equivalent	Molex 172258-1008 or equivalent
Auxiliary signal Connector (HDR3)	FCI 98414-G04-10ULF or equivalent	FCI 90311-010LF or equivalent
Auxiliary power connector (HDR4)	Molex 172298-1216 or equivalent	Molex 172258-1016 or equivalent
PMBus connector (HDR5)	Molex 015-91-6102 or equivalent	GE CC408650477, Molex 10-way, or equivalent

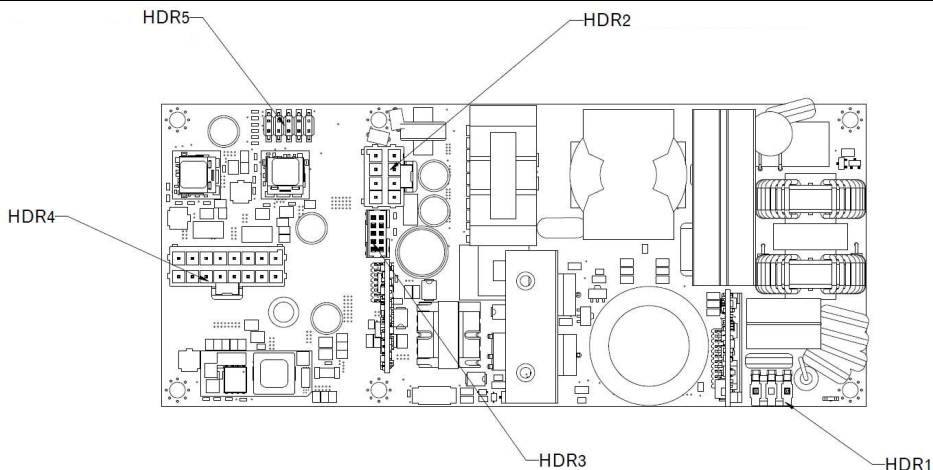

## Pinout Information

AC Input Connector (HDR1)		DC Output Connector (HDR2)		Auxiliary Connector (HDR3)	
Pin 1	Line	Pins 1, 2, 3, 4	V1+	A1, A2 = 5V standby	B1 = V1 Ishare
Pin 2	removed	Pins 5, 6, 7, 8	V1 return = 0V	A3 – not connected	B2, B3 = 5V return 0V
Pin 3	Neutral			A4 = V1 sense+	B4 = V1 OK
				A5 = V1 sense-	B5 = on/off

DC Output Connector (HDR4)		PMBus Connector (HDR5)		Connector	
V2+	1	Not connected	1, 2, 3, 4, 5, 7		
V2 return = 0V	2	Ground	6		
V2 power good	3	SMB Alert#	8		
V3+	4, 5	Clock	9		
V3 return = 0V	6, 7	Data	10		
V3 sense	8				
V3 power good	9				
V4+	10, 11				
V4 return = 0V	12, 13				
V4 sense	14				
V4 power good	15				

## FLP0412FPx Open Frame Power Supply

90 - 265Vac input; 2-4 outputs; 450W Output Power

### Ordering Information

Please contact your GE Sales Representative for pricing, availability and optional features.

**Table 1. Device Codes**

Device Code	Input Voltage Range	Output Voltages	Output Currents	V2-V4 Setting	Standby Supply	Temperature Range	Comcode
FLP0412FPMXXZ01A	90 – 265Vac	12/24/5/ 3.3V	37.5/2/12 /12A	Trim Pots	5V @ 1A	-40 to 85°C	FLP0412FPMXXZ01A
FLP0412FP4XXZ01A	90 – 265Vac	12/24/5/ 3.3V	37.5/2/12 /12A	Fixed Resistors	5V @ 1A	-40 to 85°C	FLP0412FP4XXZ01A
FLP0412FP3XXZ01A	90 – 265Vac	12/24/5V	37.5/2/12 A	Fixed Resistors	5V @ 1A	-40 to 85°C	FLP0412FP3XXZ01A
FLP0412FP2XXZ01A	90 – 265Vac	12/24V	37.5/2A	Fixed Resistors	5V @ 1A	-40 to 85°C	FLP0412FP2XXZ01A

## Contact Us

For more information, call us at

USA/Canada:

**+1 888 546 3243**, or +1 972 244 9288

Asia-Pacific:

**+86.021.54279977\*808**

Europe, Middle-East and Africa:

**+49.89.878067-280**

India:

**+91.80.28411633**

[www.gecriticalpower.com](http://www.gecriticalpower.com)

