

ISL8271MEVAL1Z Evaluation Board User Guide

The ISL8271M is a 33A step-down DC/DC power supply module with integrated digital PWM controller, synchronous power switches, an inductor and passives. Only bulk input and output capacitors are needed to finish the design. The 33A of continuous output current can be delivered without a need of airflow or a heatsink. The ISL8271M uses ChargeMode™ control architecture, which responds to a transient load within a single switching cycle.

The ISL8271MEVAL1Z evaluation board is a 3inx4.5in 4-layer FR4 board with 2 oz. in all layers. This evaluation board comes with a placeholder for pin-strap resistors to adjust output voltage, switching frequency, input undervoltage (UVLO) protection threshold, and device PMBus™ address. More configuration such as soft-start, and fault limits can be easily programmed or changed via PMBus compliant serial bus interface.

ZLUSBEVAL3Z (USB to PMBus adapter) is provided with this evaluation kit, which connects the evaluation board to a PC to activate the PMBus communication interface. The PMBus command set is accessed by using the PowerNavigator™ evaluation software from a PC running Microsoft Windows.

References

“ISL8271M” datasheet

Ordering Information

PART NUMBER	DESCRIPTION
ISL8271MEVAL1Z	ISL8271M Kit (EVB, ZLUSBEVAL3Z Adapter, USB Cable)

Key Features

- V_{IN} range of 4.5V to 14V, V_{OUT} adjustable from 0.6V to 5V
- Programmable V_{OUT} , margining, UV/OV, I_{OUT} limit, soft-start/stop, sequencing, and external synchronization
- Monitor: V_{IN} , V_{OUT} , I_{OUT} , temperature, duty cycle, switching frequency and faults
- ChargeMode™ control tunable with PMBus
- Mechanical switch for enable and power-good LED indicator

Recommended Equipment

- DC power supply with minimum 15V/25A sourcing capacity
- Electronic load capable of sinking current up to 33A
- Digital multimeters (DMMs)
- Oscilloscope with higher than 100MHz bandwidth

Functional Description

The ISL8271MEVAL1Z provides all circuitry required to evaluate the features of the ISL8271M. A majority of the features of the ISL8271M, such as compensation-free ChargeMode™ control, soft-start delay and ramp times, supply sequencing, and voltage margining are available on this evaluation board. For sequencing evaluation, the board can be connected to any Intersil digital module evaluation board that supports the Digital-DC™ (DDC) bus.

Figure 1 shows a board image of the ISL8271MEVAL1Z evaluation board.

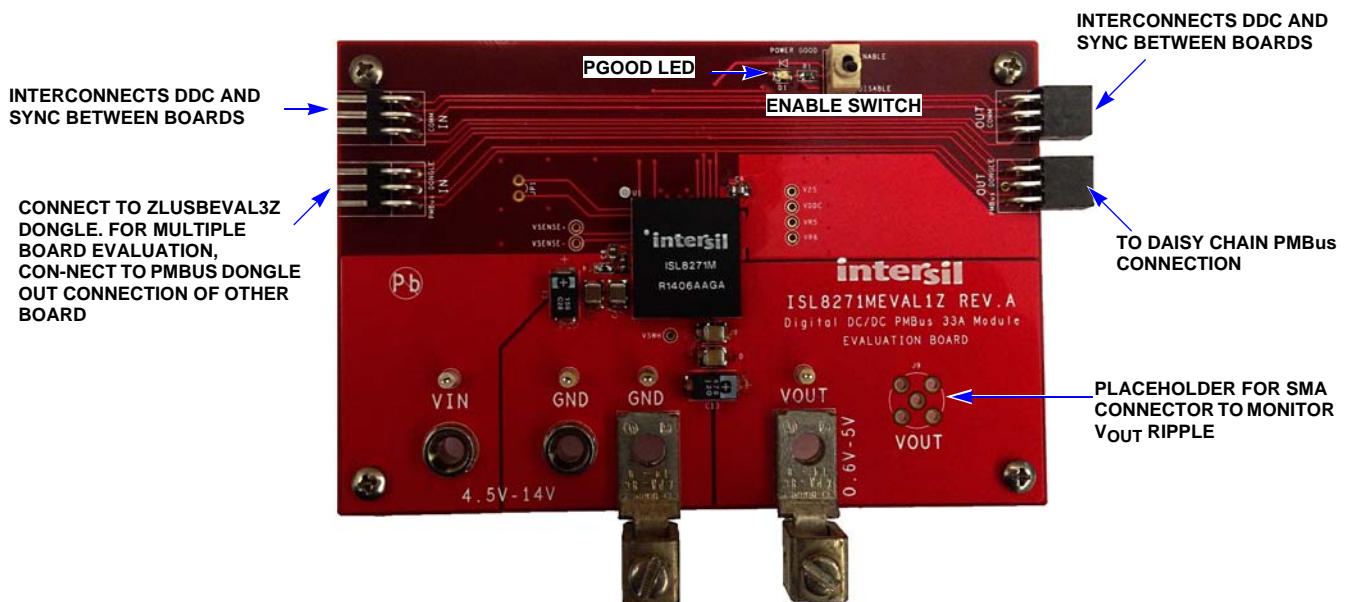

FIGURE 1. ISL8271MEVAL1Z EVALUATION BOARD IMAGE

Operation

PMBus Operation

The ISL8271M utilizes the PMBus protocol. The PMBus functionality can be controlled via ZLUSBEVAL3Z dongle from a PC running the PowerNavigator™ evaluation software in a Windows XP or Windows 7 operating systems.

Install the evaluation software from the following Intersil website: www.intersil.com/powernavigator

For board operation, connect the included ZLUSBEVAL3Z dongle to the 6-pin male connector labeled as “PMBus DONGLE IN”. Connect the desired load and an appropriate power supply to the input and connect the included USB cable to the PC running the PowerNavigator™ evaluation software. Place the ENABLE switches in “DISABLE” before turning on the power.

The evaluation software allows modification of all ISL8271M PMBus parameters. The ISL8271M device on the board has been pre-configured as described in this document, but the user may modify the operating parameters through the evaluation software or by loading a predefined set-up from a configuration file. A sample “[Configuration File](#)” on page 5 is provided and can be copied to a notepad editor to make desired changes.

The ENABLE switch can then be moved to “ENABLE” and the ISL8271MEVAL1Z board can be tested. Alternately, the PMBus ON_OFF_CONFIG and OPERATION commands may be used from the PowerNavigator™ GUI.

Quick Start Guide

Pin-Strap Option

The ISL8271MEVAL1Z can be configured in pin-strap mode with standard 1% 0603 resistors. PMBus interface is not required to evaluate ISL8271M in pin-strap mode. Output voltage (V_{OUT}), switching frequency (F_{SW}), input undervoltage protection (UVLO) threshold and device PMBus address can be changed by populating recommended resistors at placeholders provided in the evaluation board. By default, the evaluation board is programmed to regulate at $V_{OUT} = 1.2V$, $F_{SW} = 533kHz$, $UVLO = 4.5V$, and PMBus address = 28h. Follow these steps to evaluate ISL8271M in pin-strap mode.

1. Set ENABLE switch to “DISABLE”.
2. Connect Load to VOUT lug connectors (J7 and J8).
3. Connect power supply to VIN connectors (J3 and J4). Make sure power supply is not enabled when making connection.
4. Turn power supply on.
5. Set ENABLE switch to “ENABLE”.
6. Measure 1.2V VOUT at probe points (TP10 and TP11)
7. Observe switching frequency of 533kHz at probe point labeled VSWH (TP1).
8. To change VOUT, disconnect board from the set up and populated 1% standard 0603 resistor at R6 placeholder location on bottom layer. Refer to the “Output Voltage Resistor Settings” table in the [ISL8271M](#) datasheet for recommended values. By default, VOUT_MAX is set to 110% of VOUT set by the pin-strap resistor.

9. To change switching frequency, disconnect board from the setup and populated 1% standard 0603 resistor at R2 placeholder location on bottom layer. Refer to the “Switching Frequency Resistor Settings” table in the [ISL8271M](#) datasheet for recommended values.
10. To change UVLO, disconnect board from the setup and populated 1% standard 0603 resistor at R7 placeholder location on bottom layer. Refer to the “UVLO Resistor Settings” table in the [ISL8271M](#) datasheet for recommended values.

PMBus Option

ISL8271MEVAL1Z can be evaluated for all features using the provided ZLUSBEVAL3Z dongle and PowerNavigator™ evaluation software. Follow these steps to evaluate ISL8271M with PMBus option.

1. Install PowerNavigator™ software.
2. Set ENABLE switch to “DISABLE”.
3. Connect Load to VOUT lug connectors (J7 and J8).
4. Connect power supply to VIN connectors (J3 and J4). Make sure power supply is not enabled when making connection.
5. Turn power supply on.
6. Connect ZLUSBEVAL3Z dongle (USB to PMBus™ adapter) to ISL8271MEVAL1Z board to the 6-pin male connector labeled as “PMBus DONGLE IN”.
7. Connect supplied USB cable from computer to USB to ZLUSBEVAL3Z dongle.
8. Launch PowerNavigator™ software.
9. Set ENABLE switch to “ENABLE”.
10. Monitor and configure the ISL8271MEVAL1Z board using PMBus commands in the evaluation software.
11. PowerNavigator™ tutorial videos are available at Intersil website. www.intersil.com/powernavigator
12. For sequencing via Digital-DC Bus (DDC) or to evaluate multiple Intersil digital power products using a single ZLUSBEVAL3Z dongle, ISL8271M can be daisy chained with other digital power evaluation boards. PMBus address can be changed by placing a 1% standard 0603 resistor at the R5 placeholder location on the bottom layer. Refer to the “SMBus Address Resistor Selection” table in the [ISL8271M](#) datasheet for recommended values.

Thermal Considerations and Current Derating

Board layout is very critical in order to make the module operate safely and deliver maximum allowable power. To work in the high temperature environments and carry large currents, the board layout needs to be carefully designed to maximize thermal performance. To achieve this, select enough trace width, copper weight and the proper connectors.

The ISL8271MEVAL1Z evaluation board is designed for running 33A at room temperature without additional cooling systems needed. However, if the output voltage is increased or the board is operated at elevated temperatures, then the available current is derated. Refer to the derated current curves in the [ISL8271M](#) datasheet to determine the maximum output current the evaluation board can supply. θ_{JA} is measured by inserting thermocouple inside the module to measure peak junction temperature.

ISL8271MEVAL1Z Board Schematic

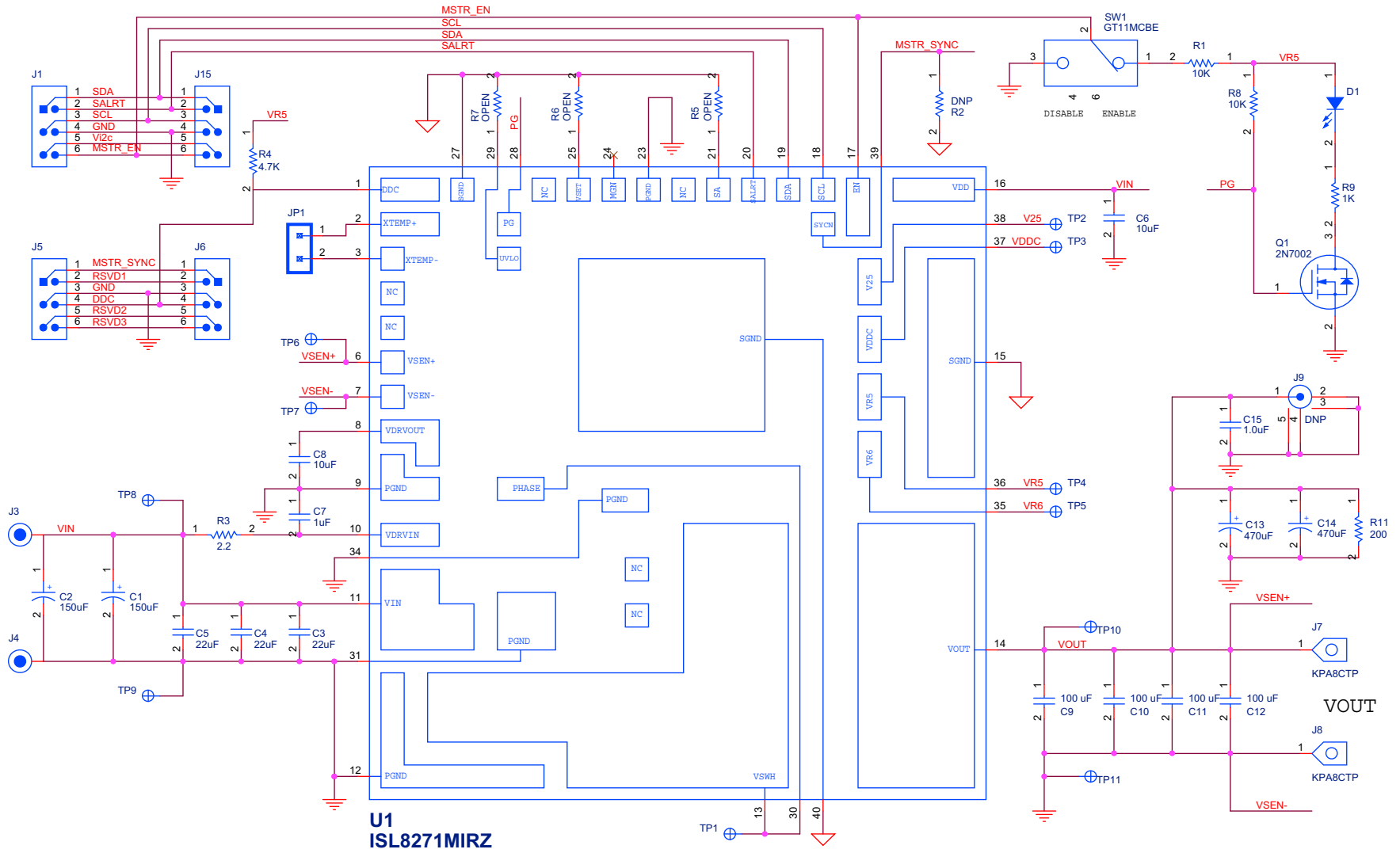

FIGURE 2. APPLICATION CIRCUIT

Application Note 1925

Bill of Materials

REFERENCE DESIGNATOR	QTY	MANUFACTURER	MANUFACTURER PART	DESCRIPTION
C7	1	MURATA	GRM188R71E105KA12D	CAP, SMD, 0603, 1μF, 25V, 10%, X7R, ROHS
C3-C5	3	MURATA	GRM32ER71E226KE15L	CAP, SMD, 1210, 22μF, 25V, 10%, X7R, ROHS
C15	1	PANASONIC	ECJ-0EB0J105K	CAP, SMD, 0402, 1μF, 6.3V, 10%, X5R, ROHS
C8	1	PANASONIC	ECJ-1VB1A106M	CAP, SMD, 0603, 10μF, 10V, 20%, X5R, ROHS
C6	1	TDK	C2012X5R1E106K	CAP, SMD, 0805, 10μF, 25V, 10%, X5R, ROHS
C9, C10, C11, C12	4	TDK	C3225X5R0J107M	CAP, SMD, 1210, 100μF, 6.3V, 20%, X5R, ROHS
C1, C2	2	SANYO/PANASONIC	16TQC150MYF	CAP-POSCAP, SMD, 7.3x4.3, 150μF, 16V, 20%, 50mΩ, ROHS
C13, C14	2	SANYO/PANASONIC	6TPF470MAH	CAP TANT 470μF 6.3V 20%
TP8, TP10	2	KEYSTONE	5000	CONN-MINI TEST PT, VERTICAL, RED, ROHS
TP9, TP11	2	KEYSTONE	5001	CONN-MINI TEST PT, VERTICAL, BLK, ROHS
J3, J4	2	KEYSTONE	575-4	CONN-JACK, MINI BANANA, 0.175 PLUG, NICKEL/BRASS, ROHS
J2, J6	2	SAMTEC	SSQ-103-02-T-D-RA	CONN-SOCKET STRIP, TH, 2X3, 2.54mm, TIN, R/A, ROHS
J1, J5	2	SAMTEC	TSW-103-08-T-D-RA	CONN-HEADER, 2X3, BRKAWY, 2.54mm, TIN, R/A, ROHS
D1	1	CHICAGO MINIATURE	CMD17-21VGC/TR8	LED, SMD, 0805, GREEN, CLEAR, 10mcd, 2.1V, 20mA, 570nm, ROHS
U1	1	INTERSIL	ISL8271MIRZ	IC-25A DIGITAL DC/DC PMBUS MODULE, 26P, QFN, ROHS
Q1	1	ON SEMICONDUCTOR	2N7002LT1G	TRANSISTOR-MOS, N-CHANNEL, SMD, SOT23, 60V, 115mA, ROHS
R4	1	YAGEO	9C06031A4701FKHFT	RES, SMD, 0603, 4.7k, 1/10W, 1%, TF, ROHS
R2, R5, R6, R7	0			RESISTOR, SMD, 0603, 0.1%, MF, DNP-PLACE HOLDER
R3	1	PANASONIC	ERJ-3RQF2R2V	RES, SMD, 0603, 2.2Ω, 1/10W, 1%, TF, ROHS
R9	1	PANASONIC	ERJ-3EKF1001V	RES, SMD, 0603, 1k, 1/10W, 1%, TF, ROHS
R1, R8	2	KOA	RK73H1JT1002F	RES, SMD, 0603, 10k, 1/10W, 1%, TF, ROHS
R11	1	PANASONIC	ERJ-8ENF2000V	RES, SMD, 1206, 200Ω, 1/4W, 1%, TF, ROHS
SW1	1	ITT CANNON	GT11MCBE	SWITCH-TOGGLE, THRU-HOLE, SPDT, 5P, ROHS
J7, J8	2	BERG/FCI	KPA8CTP	HDWARE, MTG, CABLE TERMINAL, 6-14AWG, LUG and SCREW, ROHS
J9	0	TE CONNECTIVITY	5-1814832-1	DO NOT POPULATE
JP1	0			DO NOT POPULATE
TP1-TP7	0			DO NOT POPULATE

Application Note 1925

Configuration File

Sample Configuration File for ISL8271M Module. Copy and paste (from RESTORE_FACTORY TO ### End User Store) to a notepad and save it as Confile_file_name.txt. The # symbol is used for a comment line. Following settings are already loaded to ISL8271M module as factory defaults.

```
RESTORE_FACTORY                # reset device to the factory setting
STORE_USER_ALL                 # Clears user memory space
# VOUT Related
VOUT_COMMAND                   0x2666                # 1.2 V
VOUT_MAX                       0x2a3c                # 1.32 V
VOUT_MARGIN_HIGH               0x2851                # 1.26 V
VOUT_MARGIN_LOW                0x247a                # 1.14 V
VOUT_OV_FAULT_LIMIT           0x2c28                # 1.38 V
VOUT_OV_FAULT_RESPONSE        0x80                  # Disable and no retry
VOUT_OV_WARN_LIMIT            0x2a3c                # 1.32 V
VOUT_UV_WARN_LIMIT            0x228f                # 1.08 V
VOUT_UV_FAULT_LIMIT           0x20a3                # 1.02 V
VOUT_UV_FAULT_RESPONSE        0x80                  # Disable and no retry
POWER_GOOD_ON                  0x228f                # 1.08 V
VOUT_TRANSITION_RATE           0xba00                # 1 mV/us
VOUT_DROOP                     0x0000                # 0 mV/A
VOUT_CAL_OFFSET                0x0000                # 0 mV/A
# IOUT Related
IOUT_CAL_GAIN                  0xb2ae                # 0.67 mV/A
IOUT_CAL_OFFSET                0x0000                # 0 A
IOUT_OC_FAULT_LIMIT           0xe280                # 40 A
IOUT_UC_FAULT_LIMIT           0xe57f                # -40A
MFR_IOUT_OC_FAULT_RESPONSE    0x80                  # Disable and no retry
MFR_IOUT_UC_FAULT_RESPONSE    0x80                  # Disable and no retry
ISENSE_CONFIG                  0x05                  # 256ns Blanking time, Mid-Range
# Other Faults
OT_FAULT_LIMIT                 0xeb08                # 125 °C
OT_FAULT_RESPONSE             0x80                  # Disable and no retry
OT_WARN_LIMIT                  0xeb70                # 110 °C
UT_WARN_LIMIT                  0xdc40                # -30 °C
UT_FAULT_LIMIT                 0xe530                # -45 °C
UT_FAULT_RESPONSE             0x80                  # Disable and no retry
VIN_OV_FAULT_LIMIT            0xd380                # 14 V
VIN_OV_FAULT_RESPONSE         0x80                  # Disable and no retry
VIN_OV_WARN_LIMIT             0xd327                # 12.609 V
VIN_UV_WARN_LIMIT             0xca79                # 4.945 V
VIN_UV_FAULT_LIMIT            0xca40                # 4.5 V
VIN_UV_FAULT_RESPONSE         0x80                  # Disable and no retry
#Enable, Timing and Sequence Related
ON_OFF_CONFIG                  0x17                  # Pin Enable, Immediate Off
TON_DELAY                      0xca80                # 5 ms
TON_RISE                       0xca80                # 5 ms
TOFF_DELAY                     0xca80                # 5 ms
TOFF_FALL                      0xca80                # 5 ms
POWER_GOOD_DELAY              0xba00                # 1 ms
FREQUENCY_SWITCH               0x0215                # Sequence Disabled
SYNC_CONFIG                    0x00                  # Use Pin-strap for FSW setting
SEQUENCE                       0x0000                # 533 kHz
# Manufacturer Related
MFR_ID                         Intersil Corp         # Example Only
MFR_MODEL                      ISL8271MEVAL1Z       # Example Only
MFR_REVISION                   Rev-1                 # Example Only
MFR_LOCATION                   Milpitas, CA         # Example Only
MFR_DATE                       3/14/2014            # Example Only
MFR_SERIAL                     1234                 # Example Only
USER_DATA_00                   Module                # Example Only
# Advance Settings
USER_CONFIG                    0x00                  # Open Drain PG, XTEMP Disabled
DDC_CONFIG                     0x01                  # DDC rail ID = 1
DDC_GROUP                      0x00000000           # All Broadcast disabled
# Loop Compensation
ASCR_CONFIG                    0x15a0100            # ASCR gain = 256, Residual = 90
STORE_USER_ALL                 # Store all above settings to NVRAM
### End User Store
```

Measured Data

The following data was acquired using a ISL8271MEVAL1Z evaluation board.

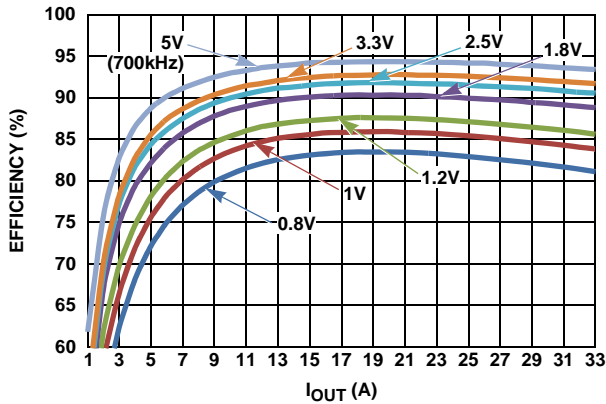

FIGURE 3. EFFICIENCY vs OUTPUT CURRENT AT $V_{IN} = 12V$ AND $F_{SW} = 533kHz$ FOR VARIOUS OUTPUT VOLTAGES

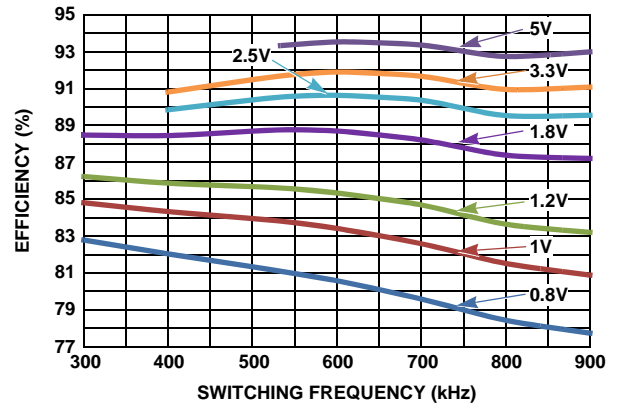

FIGURE 4. EFFICIENCY vs SWITCHING FREQUENCY AT $V_{IN} = 12V$ AND $I_{OUT} = 33A$ FOR VARIOUS OUTPUT VOLTAGES

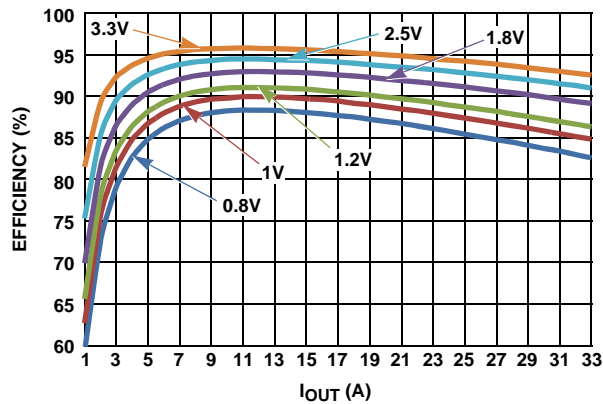

FIGURE 5. EFFICIENCY vs OUTPUT CURRENT AT $V_{IN} = 5V$ AND $F_{SW} = 533kHz$ FOR VARIOUS OUTPUT VOLTAGES

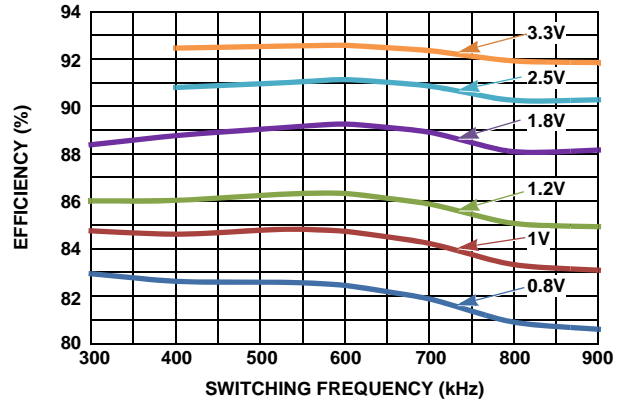

FIGURE 6. EFFICIENCY vs SWITCHING FREQUENCY AT $V_{IN} = 5V$ AND $I_{OUT} = 33A$ FOR VARIOUS OUTPUT VOLTAGES

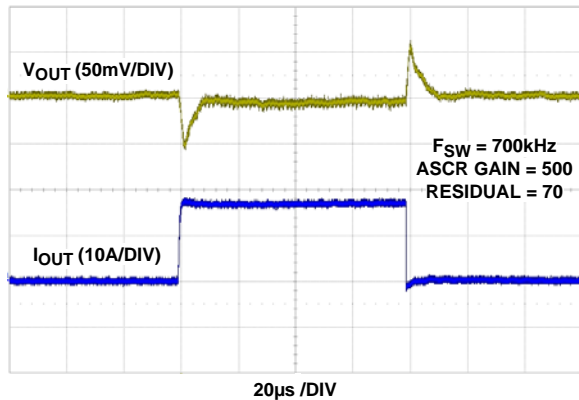

FIGURE 7. LOAD TRANSIENT RESPONSE AT $V_{IN} = 12V$, $V_{OUT} = 2.5V$ WITH HIGH BANDWIDTH ASCR PARAMETERS

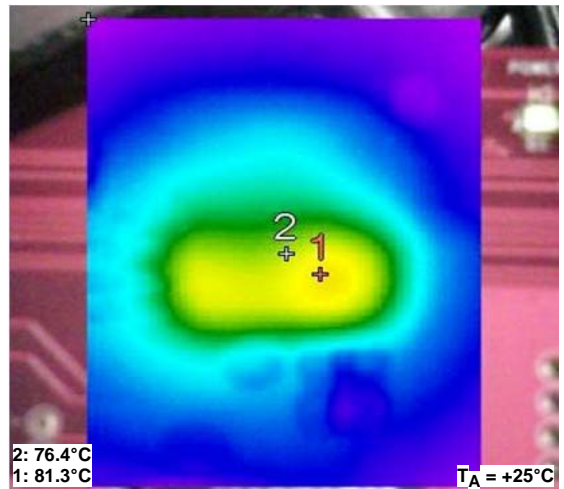

FIGURE 8. THERMAL IMAGE, $12V_{IN}$ TO $1.2V_{OUT}$, $I_{OUT} = 33A$, $T_A = +25^\circ C$, $F_{SW} = 533kHz$, NO AIR FLOW.

ISL8271MEVAL1Z Board Layout

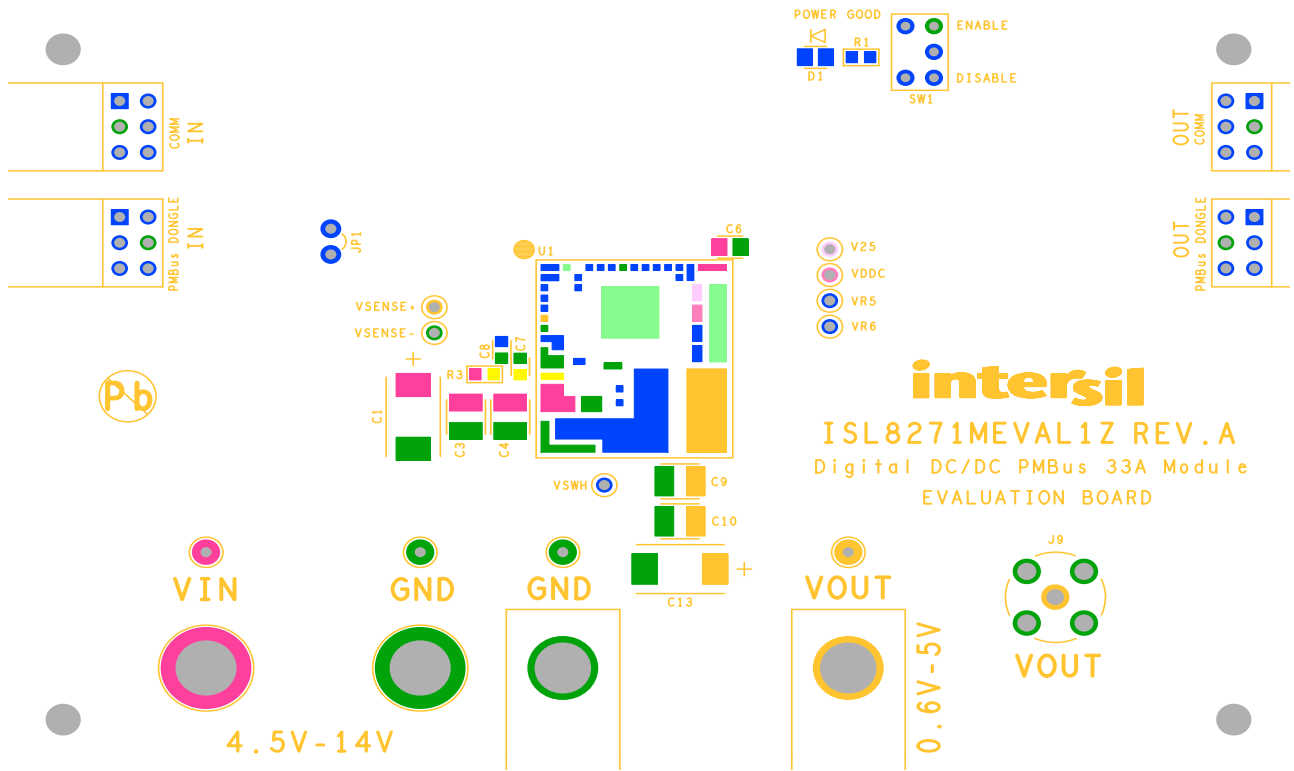

FIGURE 9. PCB - TOP SILK SCREEN

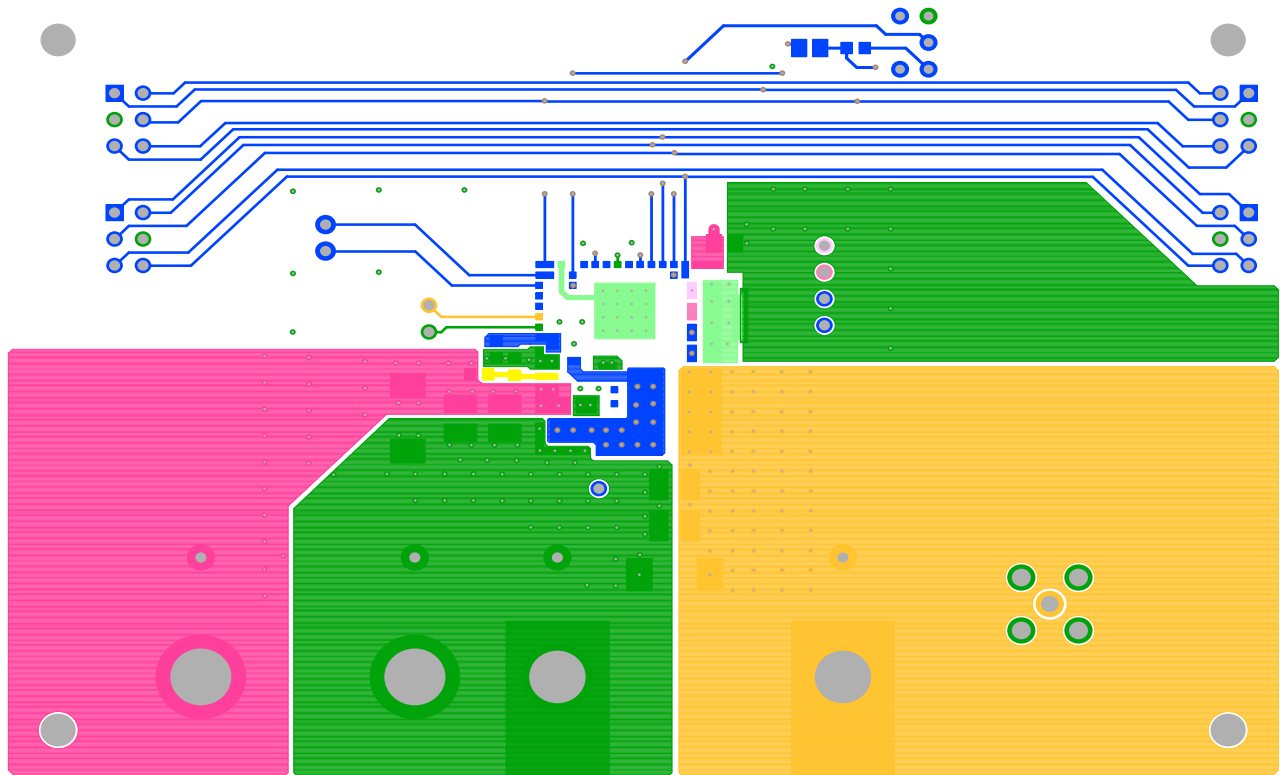

FIGURE 10. PCB - TOP LAYER

ISL8271MEVAL1Z Board Layout (Continued)

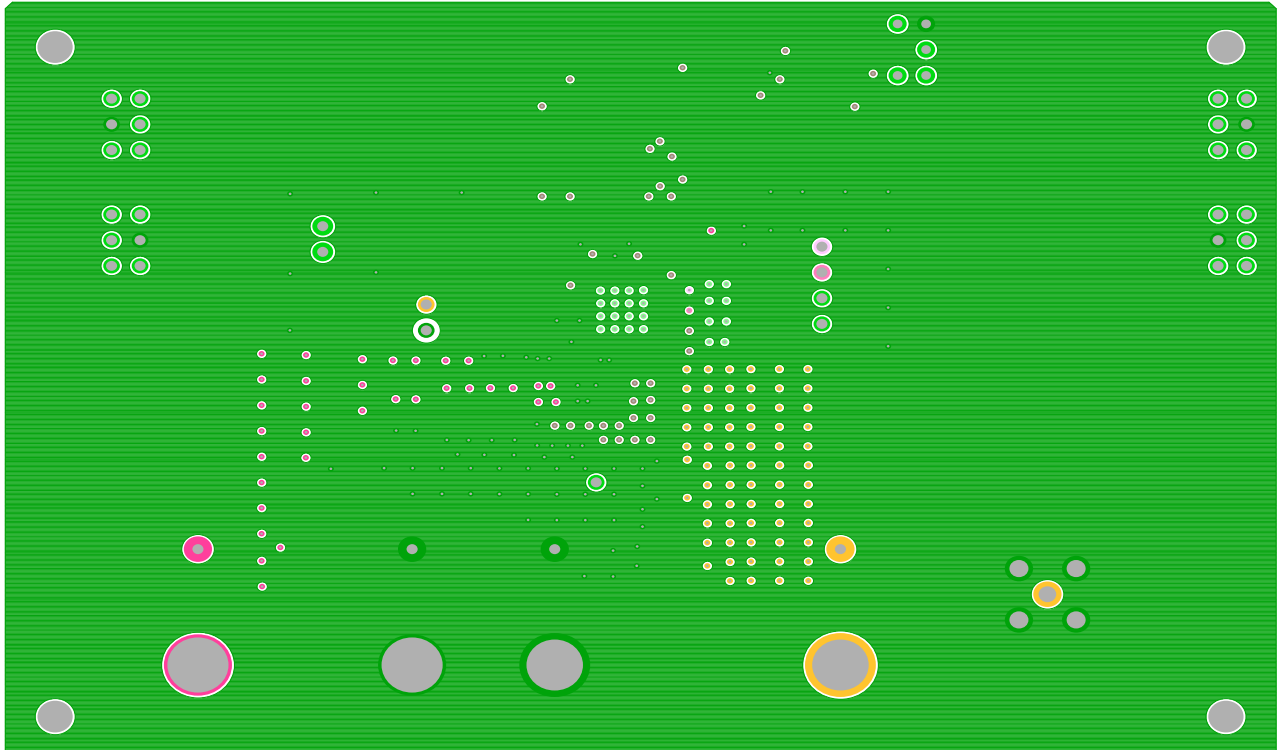

FIGURE 11. PCB - INNER LAYER - LAYER 2 (TOP VIEW)

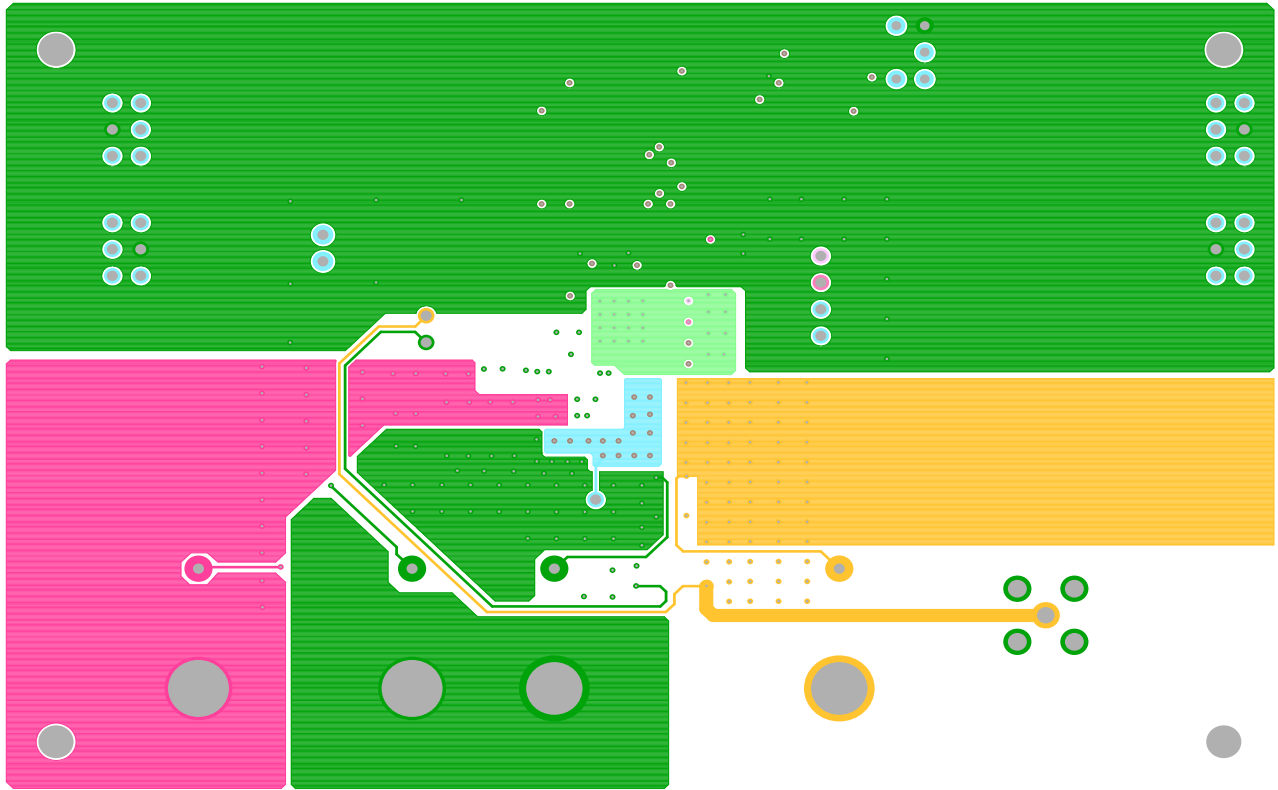

FIGURE 12. PCB - INNER LAYER - LAYER 3 (TOP VIEW)

ISL8271MEVAL1Z Board Layout (Continued)

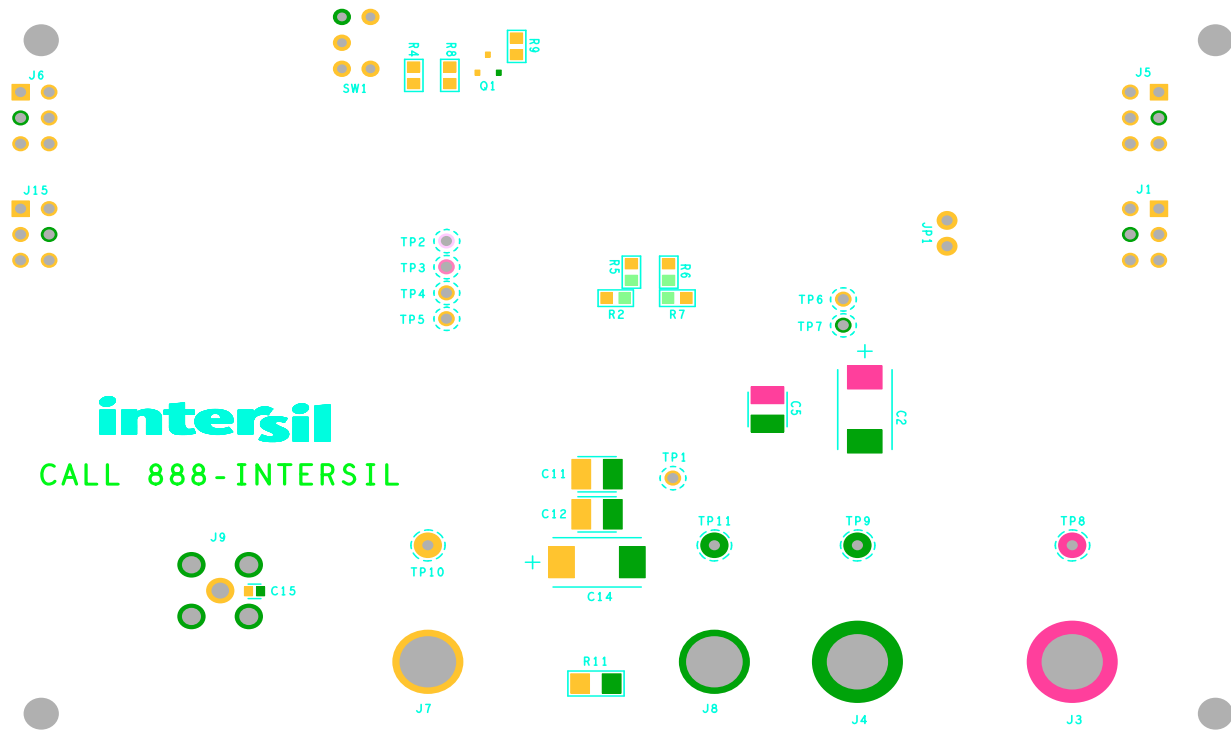

FIGURE 13. PCB - BOTTOM LAYER (BOTTOM VIEW)

Intersil Corporation reserves the right to make changes in circuit design, software and/or specifications at any time without notice. Accordingly, the reader is cautioned to verify that the Application Note or Technical Brief is current before proceeding.

For information regarding Intersil Corporation and its products, see www.intersil.com