

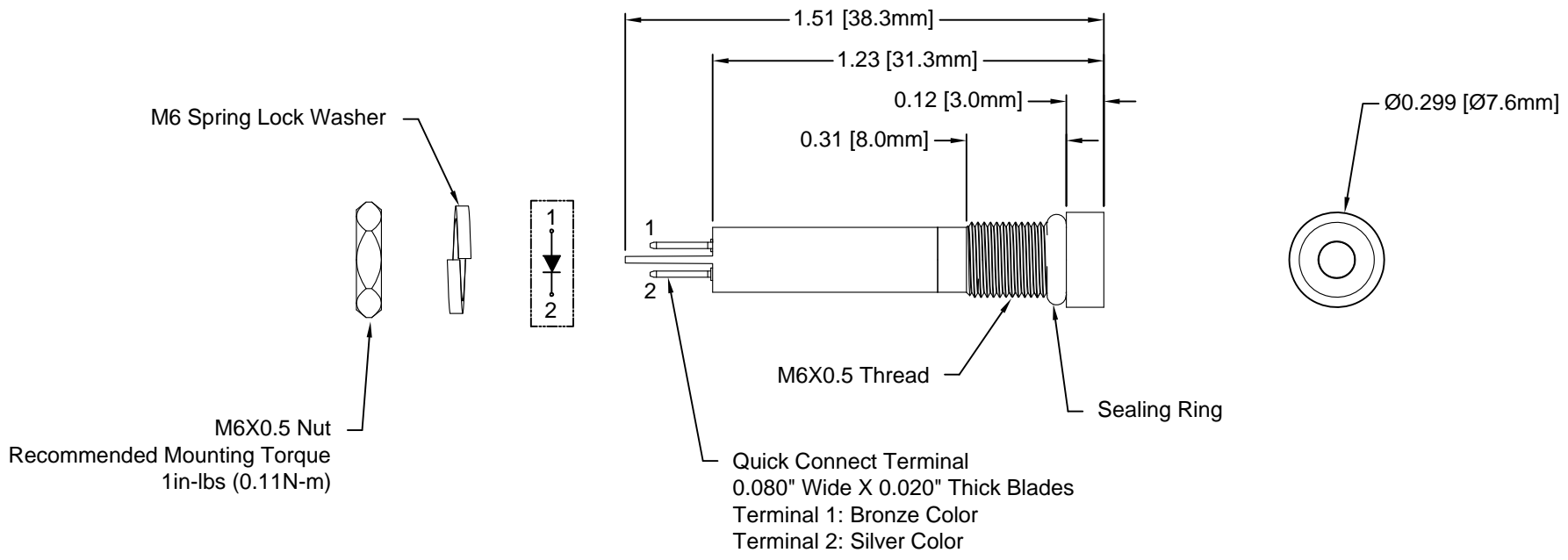

REV.	DESCRIPTION	DATE	APPROVED
A	Engineering Release	08/18/14	J. C.
B	Engineering Update w/o Changes	08/11/16	J. C.
C	Removed P/N Per EOL NOTICE 052317	07/24/17	J. C.

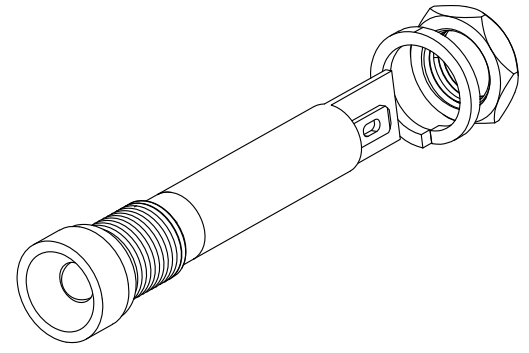

M6X0.5 Nut
Recommended Mounting Torque
1in-lbs (0.11N-m)

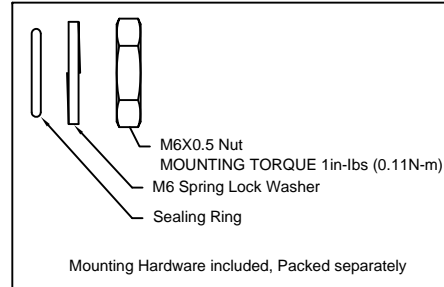
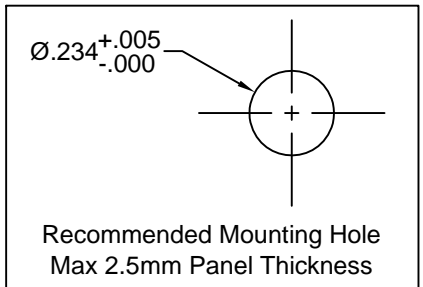

- NOTES:**
1. SEALED TO IP54 RATING
 2. VOLTAGE INPUT OPTIONS: 12V/24V
 3. ROHS COMPLIANT
 4. MOUNTING HARDWARE PACKED SEPARATELY NON-ASSEMBLED
 5. INSERT SEALING RING ON PANEL MOUNT ASSEMBLY PRIOR TO PANEL INSTALLATION

STANDARD TOLERANCE (UNLESS OTHERWISE SPECIFIED)		 4 THOMAS, IRVINE, CA. 92618 TEL: (949) 951-8808 FAX: (949) 951-3974	
DECIMALS	ANGULAR		
.X ± .1	X° ± 1°	 TITLE: MPR6-3 SERIES, IP54 RATED PANEL MOUNT INDICATOR	
.XX ± .02			PART NO: MPR6-3XDXXV
.XXX ± .010			REVISION: C
DESIGNED: M. Doan	DATE: 08/18/14	CAGE CODE : 32559	SHEET # 1 OF 2
CHECKED: B. Oliver	DATE: 08/18/14	CAD GENERATED DOCUMENT. DO NOT MEASURE DRAWING.	

REV.	DESCRIPTION	DATE	APPROVED
	SEE SHEET #1		

Part Number	Dominant Wave Length λ_d (nm)	Emitted Color	Lens Appearance	Voltage	Luminous Intensity (mcd)	Viewing Angle (degree)
MPR6-3RD12V	625	Red	Diffused	12V	310	45
MPR6-3GD12V	525	Green	Diffused	12V	2090	45
MPR6-3YD12V	590	Yellow	Diffused	12V	520	45
MPR6-3BWD12V	465	Blue	Diffused	12V	310	45
MPR6-3WD12V	x=0.28, y=0.30	White	Diffused	12V	2610	45
MPR6-3RD24V	625	Red	Diffused	24V	310	45
MPR6-3GD24V	525	Green	Diffused	24V	2090	45
MPR6-3YD24V	590	Yellow	Diffused	24V	520	45
MPR6-3BWD24V	465	Blue	Diffused	24V	310	45
MPR6-3WD24V	x=0.28, y=0.30	White	Diffused	24V	2610	45

ABSOLUTE MAXIMUM RATINGS (Ta = 25°C)

POWER INPUT _____ 0.5W MAX
 OPERATING TEMPERATURE RANGE _____ -40°C ~ 80°C
 STORAGE TEMPERATURE _____ -40°C ~ 80°C
 TERMINAL SOLDERING TEMPERATURE _____ 260°C, 5s

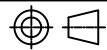
STANDARD TOLERANCE (UNLESS OTHERWISE SPECIFIED) DECIMALS ANGULAR		 4 THOMAS, IRVINE, CA. 92618 TEL: (949) 951-8808 FAX: (949) 951-3974	
			
DESIGNED: M. Doan	DATE: 08/18/14	TITLE: MPR6-3 SERIES, IP54 RATED PANEL MOUNT INDICATOR	
CHECKED: B. Oliver	DATE: 08/18/14	PART NO: MPR6-3XDXXV	REVISION: C
		CAGE CODE : 32559	SHEET # 2 OF 2
CAD GENERATED DOCUMENT. DO NOT MEASURE DRAWING.			