

User Manual

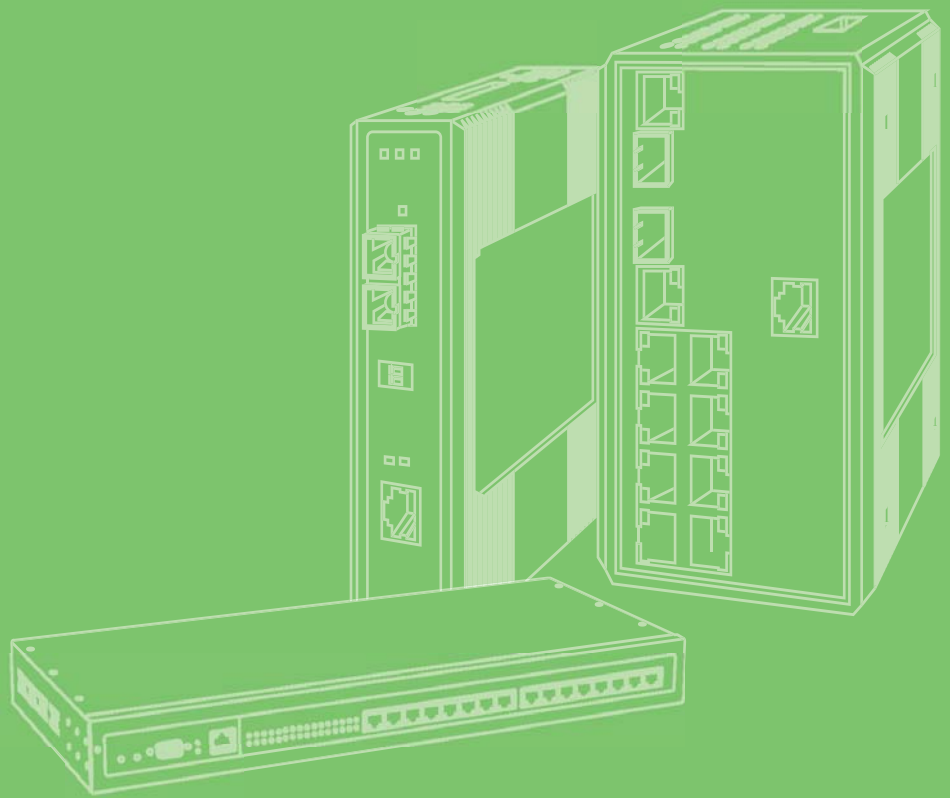

EKI-122X Series

1/2/4-port Modbus Gateway

ADVANTECH

Enabling an Intelligent Planet

Copyright

The documentation and the software included with this product are copyrighted 2016 by Advantech Co., Ltd. All rights are reserved. Advantech Co., Ltd. reserves the right to make improvements in the products described in this manual at any time without notice. No part of this manual may be reproduced, copied, translated or transmitted in any form or by any means without the prior written permission of Advantech Co., Ltd. Information provided in this manual is intended to be accurate and reliable. However, Advantech Co., Ltd. assumes no responsibility for its use, nor for any infringements of the rights of third parties, which may result from its use.

Acknowledgements

Intel and Pentium are trademarks of Intel Corporation.

Microsoft Windows and MS-DOS are registered trademarks of Microsoft Corp.

All other product names or trademarks are properties of their respective owners.

Product Warranty (5 years)

Advantech warrants to you, the original purchaser, that each of its products will be free from defects in materials and workmanship for five years from the date of purchase.

This warranty does not apply to any products which have been repaired or altered by persons other than repair personnel authorized by Advantech, or which have been subject to misuse, abuse, accident or improper installation. Advantech assumes no liability under the terms of this warranty as a consequence of such events.

Because of Advantech's high quality-control standards and rigorous testing, most of our customers never need to use our repair service. If an Advantech product is defective, it will be repaired or replaced at no charge during the warranty period. For out-of-warranty repairs, you will be billed according to the cost of replacement materials, service time and freight. Please consult your dealer for more details.

If you think you have a defective product, follow these steps:

1. Collect all the information about the problem encountered. (For example, CPU speed, Advantech products used, other hardware and software used, etc.) Note anything abnormal and list any on screen messages you get when the problem occurs.
2. Call your dealer and describe the problem. Please have your manual, product, and any helpful information readily available.
3. If your product is diagnosed as defective, obtain an RMA (return merchandise authorization) number from your dealer. This allows us to process your return more quickly.
4. Carefully pack the defective product, a fully-completed Repair and Replacement Order Card and a photocopy proof of purchase date (such as your sales receipt) in a shippable container. A product returned without proof of the purchase date is not eligible for warranty service.
5. Write the RMA number visibly on the outside of the package and ship it prepaid to your dealer.

Declaration of Conformity

CE

This product has passed the CE test for environmental specifications when shielded cables are used for external wiring. We recommend the use of shielded cables. This kind of cable is available from Advantech. Please contact your local supplier for ordering information.

This product has passed the CE test for environmental specifications. Test conditions for passing included the equipment being operated within an industrial enclosure. In order to protect the product from being damaged by ESD (Electrostatic Discharge) and EMI leakage, we strongly recommend the use of CE-compliant industrial enclosure products.

FCC Class A

Note: This equipment has been tested and found to comply with the limits for a Class A digital device, pursuant to part 15 of the FCC Rules. These limits are designed to provide reasonable protection against harmful interference when the equipment is operated in a commercial environment. This equipment generates, uses, and can radiate radio frequency energy and, if not installed and used in accordance with the instruction manual, may cause harmful interference to radio communications. Operation of this equipment in a residential area is likely to cause harmful interference in which case the user will be required to correct the interference at his own expense.

Technical Support and Assistance

1. Visit the Advantech web site at www.advantech.com/support where you can find the latest information about the product.
2. Contact your distributor, sales representative, or Advantech's customer service center for technical support if you need additional assistance. Please have the following information ready before you call:
 - Product name and serial number
 - Description of your peripheral attachments
 - Description of your software (operating system, version, application software, etc.)
 - A complete description of the problem
 - The exact wording of any error messages

Warnings, Cautions and Notes

Warning! Warnings indicate conditions, which if not observed, can cause personal injury!



Caution! Cautions are included to help you avoid damaging hardware or losing data. e.g.



There is a danger of a new battery exploding if it is incorrectly installed. Do not attempt to recharge, force open, or heat the battery. Replace the battery only with the same or equivalent type recommended by the manufacturer. Discard used batteries according to the manufacturer's instructions.

Note! Notes provide optional additional information.



Document Feedback

To assist us in making improvements to this manual, we would welcome comments and constructive criticism. Please send all such - in writing to: support@advantech.com

Packing List

Before setting up the system, check that the items listed below are included and in good condition. If any item does not accord with the table, please contact your dealer immediately.

- 1 x EKI-1221 or EKI-1222 or EKI-1224 Modbus Gateway
- 1 x Terminal Block
- 1 x Document and software CD
- 2 x Wall/panel mount kit

Safety Instructions

1. Read these safety instructions carefully.
2. Keep this User Manual for later reference.
3. Disconnect this equipment from any AC outlet before cleaning. Use a damp cloth. Do not use liquid or spray detergents for cleaning.
4. For plug-in equipment, the power outlet socket must be located near the equipment and must be easily accessible.
5. Keep this equipment away from humidity.
6. Put this equipment on a reliable surface during installation. Dropping it or letting it fall may cause damage.

7. The openings on the enclosure are for air convection. Protect the equipment from overheating. **DO NOT COVER THE OPENINGS.**
8. Make sure the voltage of the power source is correct before connecting the equipment to the power outlet.
9. Position the power cord so that people cannot step on it. Do not place anything over the power cord.
10. All cautions and warnings on the equipment should be noted.
11. If the equipment is not used for a long time, disconnect it from the power source to avoid damage by transient overvoltage.
12. Never pour any liquid into an opening. This may cause fire or electrical shock.
13. Never open the equipment. For safety reasons, the equipment should be opened only by qualified service personnel.
14. If one of the following situations arises, get the equipment checked by service personnel:
 15. The power cord or plug is damaged.
 16. Liquid has penetrated into the equipment.
 17. The equipment has been exposed to moisture.
 18. The equipment does not work well, or you cannot get it to work according to the user's manual.
 19. The equipment has been dropped and damaged.
 20. The equipment has obvious signs of breakage.
21. **DO NOT LEAVE THIS EQUIPMENT IN AN ENVIRONMENT WHERE THE STORAGE TEMPERATURE MAY GO BELOW -40°C (-40°F) OR ABOVE 75°C (167°F). THIS COULD DAMAGE THE EQUIPMENT. THE EQUIPMENT SHOULD BE IN A CONTROLLED ENVIRONMENT.**
22. **CAUTION: DANGER OF EXPLOSION IF BATTERY IS INCORRECTLY REPLACED. REPLACE ONLY WITH THE SAME OR EQUIVALENT TYPE RECOMMENDED BY THE MANUFACTURER, DISCARD USED BATTERIES ACCORDING TO THE MANUFACTURER'S INSTRUCTIONS.**

Safety Precaution - Static Electricity

Follow these simple precautions to protect yourself from harm and the products from damage.

- To avoid electrical shock, always disconnect the power from your PC chassis before you work on it. Don't touch any components on the CPU card or other cards while the PC is on.
- Disconnect power before making any configuration changes. The sudden rush of power as you connect a jumper or install a card may damage sensitive electronic components.

Contents

Chapter 1	Introduction	1
1.1	Overview	2
1.2	Device Features.....	2
Chapter 2	Getting Started	3
2.1	Understanding Modbus Gateways.....	4
2.1.1	Protocol Overview.....	4
	Figure 2.1 Modbus System Architecture 1	5
	Figure 2.2 Modbus System Architecture 2	5
2.1.2	Modbus RTU.....	5
2.1.3	Modbus ASCII.....	5
2.1.4	Modbus ASCII.....	6
2.2	Specifications.....	6
2.3	Hardware	8
2.3.1	Front View.....	8
	Figure 2.3 Front View	8
	Figure 2.4 Front View	9
	Figure 2.5 Front View	10
2.3.2	Rear View	11
	Figure 2.6 Rear View.....	11
	Figure 2.7 Rear View.....	12
2.3.3	Top View.....	12
	Figure 2.8 Top View	12
2.3.4	LED Indicators	13
	Figure 2.9 System LED Panel	13
2.3.5	Dimensions.....	14
	Figure 2.10 EKI-1221 and EKI-1222 Dimensions.....	14
	Figure 2.11 EKI-1224 Dimensions.....	15
2.4	Connecting Hardware	16
2.4.1	Choosing a Location	16
	Figure 2.12 Installing the DIN-Rail Mounting Kit.....	16
	Figure 2.13 Removing the DIN-Rail.....	17
	Figure 2.14 Installing Wall Mount Plates	18
	Figure 2.15 Wall Mounting Screw Dimensions.....	19
	Figure 2.16 Wall Mount Installation	19
2.4.2	Serial Connection	20
	Figure 2.17 DB9 Pin Assignment	20
2.4.3	Power Connection	20
	Figure 2.18 Power Wiring for EKI-122X Series	21
Chapter 3	Configuration	22
3.1	Configuration Utility Overview.....	23
3.2	Installing the Configuration Utility.....	23
	Figure 3.1 InstallShield Wizard 1 of 4.....	24
	Figure 3.2 InstallShield Wizard 2 of 4.....	24
	Figure 3.3 InstallShield Wizard 3 of 4.....	25
	Figure 3.4 InstallShield Wizard 4 of 4.....	25
3.3	Menu Bar	26
	Figure 3.5 Configuration Utility Overview	26
3.4	Quick Tool Bar	27
3.4.1	Utility Settings.....	28

	Figure 3.7	View > Settings > Main Form Setting	28
	Figure 3.8	View > Settings > Device Manager	29
3.4.2		Discovering Your Device Server	30
	Figure 3.9	Open View of Serial Device Configuration Utility....	30
	Figure 3.10	Selecting a Group.....	31
	Figure 3.11	Selecting a Device.....	31
	Figure 3.12	Viewing Basic Settings	31
3.4.3		Network Settings.....	32
	Figure 3.13	Utility Overview.....	32
	Figure 3.14	Network Settings Overview	33
	Figure 3.15	Reset Device	34
3.5		Administrator Settings.....	35
3.5.1		Locate the Serial Device Server	35
	Figure 3.16	Locate the Serial Device Server	35
3.5.2		Securing the Serial Device Server	36
	Figure 3.17	Lock the Serial Device Server	36
	Figure 3.18	Enter a Password	37
	Figure 3.19	Reset Device	37
	Figure 3.20	Unlock the Serial Device Server.....	38
3.5.3		Restore to Factory Default Settings.....	39
	Figure 3.21	Restore to Factory Default Settings.....	39
3.5.4		Resetting the Device.....	39
	Figure 3.22	Reset Device	40
3.5.5		Add to Favorite.....	41
	Figure 3.23	Add to Favorite	41
3.5.6		Update Firmware	41
	Figure 3.24	Update Firmware	42

Chapter 4 Web Interface43

4.1		Overview	44
4.2		Accessing the Web Page	44
	4.2.1	Accessing the Web Page via Configuration Utility	44
		Figure 4.1 Accessing the Web Page via Configuration Utility..	44
	4.2.2	Accessing the Web Page via Web Browser.....	45
4.3		System	45
	Figure 4.2	Setting Time Zone	45
4.4		Ethernet Configuration	46
	Figure 4.3	Ethernet Configuration.....	46
4.5		Port Configuration	47
	4.5.1	Basic.....	47
		Figure 4.4 Port Configuration > Basic.....	47
	4.5.2	Operation	48
		Figure 4.5 Master Mode.....	48
		Figure 4.6 Slave Mode.....	48
		Figure 4.7 Port Configuration > Operation.....	49
		Figure 4.8 Port Configuration > Operation.....	49
4.6		Monitor	50
	4.6.1	Setting.....	50
		Figure 4.9 Monitor > Setting	50
	4.6.2	Statistic	51
	4.6.3	Connected IP	52
4.7		Auto Warning (Alarm).....	52
	4.7.1	Setting.....	52
		Figure 4.12 Alarm > Setting	53
	4.7.2	Event.....	54
		Figure 4.13 Alarm > Event.....	54
4.8		Syslogd	55
	4.8.1	Syslogd Setting	55

	Figure 4.14 Syslogd > Syslogd Setting	55
4.8.2	Syslogd Message	55
	Figure 4.15 Syslogd > Syslogd Message	55
4.8.3	Modbus IP Mapping.....	55
	Figure 4.16 Syslogd > Modbus IP Mapping	55
4.8.4	Modbus Port Mapping.....	56
	Figure 4.17 Syslogd > Modbus Port Mapping	56
4.9	Tools	56
4.9.1	Ping.....	56
	Figure 4.18 Tools > Ping	56
4.9.2	Reboot.....	57
	Figure 4.19 Tools > Reboot.....	57
4.10	Management.....	57
4.10.1	Log File.....	57
4.10.2	Change Password	58
	Figure 4.21 Management > Change Password.....	58
4.10.3	Export Device Settings	58
	Figure 4.22 Management > Export.....	58
4.10.4	Import Device Settings.....	58
	Figure 4.23 Management > Import	58

Chapter 1

Introduction

1.1 Overview

Advantech's EKI-1221/EKI-1222/EKI-1224 series of Modbus Gateways (the following manual will use EKI-122X series instead of complete model name) are a robust, feature-rich, and cost effective way to integrate Ethernet and Serial Modbus devices. The EKI-122X series provides one, two or four serial ports, two Ethernet ports, a wide range of power inputs, and a compact slim design, making them an ideal solution for connecting multiple Modbus/ RTU and Modbus/ASCII serial devices to Modbus TCP (Ethernet).

Originally developed for PLCs in industrial automation and manufacturing control applications, Modbus is one of the most popular open standard protocols in use today. The communication mode can be Modbus RTU/ASCII (Serial) or Modbus TCP (Ethernet). Many industrial devices use Modbus as their communication standard. However, the Ethernet-based Modbus protocol is different from the original serial-based protocols that a Modbus Gateway is needed to be a bridge for integration.

The two Ethernet ports allow the EKI-122X series to establish two separated Ethernet connections to two Ethernet domains or two Ethernet switches in the same domain. Through a dual Ethernet connection, the EKI-122X series greatly improves the device connectivity reliability, increase system stability, and simplify the redundant configuration.

The Modbus/RTU and Modbus/ASCII protocols define how a "master" device polls one or more "slave" devices and write real-time data over RS-232, RS-422, or RS-485 serial data communication. The EKI-122X series provides a feature that can allow users to select master or slave operation for each serial port. The EKI-122X series not only allows Ethernet master can control serial slaves, but also allow serial masters to control Ethernet or serial slaves. Furthermore, the EKI-122X series can allow both Ethernet and serial slaves to be controlled by both Ethernet and serial masters.

The EKI-122X series supports various operating modes: RTU Master, RTU Slave, ASCII Master, and ASCII Slave.

1.2 Device Features

- Provides 2 x 10/100 Mbps Ethernet ports for LAN redundancy
- Integration of Modbus TCP and Modbus RTU/ASCII networks
- Supports up to 921.6 kbps, and any baud rate setting
- Supports up to 16 connections and 32 requests simultaneously
- Auto searching slave ID over configuration utility
- Software selectable RS-232/422/485 communication
- Mounts on DIN-rail and Wall mount
- Built-in 15 KV ESD protection for all serial signals
- Automatic RS-485 data flow control
- Supports surge protection for D.C. power ports with line to line 2 KV, and line to earth 4 KV; for signal ports with 4 KV.
- 'I' models support a wide operating temperature
- 'CI' models support isolation and wide operating temperature

Chapter 2

Getting Started

2.1 Understanding Modbus Gateways

Networks have become increasingly vital for industrial automation applications. Many control devices today do not have a network port and can only communicate with a dedicated local PC or control panel. Advantech's revolutionary network-enabling technology is now allowing control devices with serial ports to connect to the Ethernet and share networks quickly and cost-effectively. The EKI-122X Series are network-based, Modbus gateways for integrating new and existing Modbus/RTU and Modbus/ASCII serial devices to newer TCP/IP networked-based devices. Manufacturers, system integrators, and end users can now take advantage of Modbus gateways to create networked applications for remote managing and accessing data for their control devices that wasn't possible before.

2.1.1 Protocol Overview

Originally developed for PLCs in industrial automation and manufacturing control application, Modbus has become one of the most popular open standard protocols in use today. When it comes to planning data communication for open, multi-vendor industrial control systems, Modbus is the first choice of end-users and integrators.

Although it's not the most powerful protocol available, its rare simplicity allows not only rapid implementation, but also remains flexible enough to be applied in virtually all industrial situations. The communication mode of Modbus can be ASCII, RTU, or TCP/IP. Modbus gateways are used to support applications such as protocol conversion between serial (Modbus/ASCII or Modbus/RTU) and networked (Modbus/TCP) Modbus devices or it can be used to bridge Modbus serial devices over TCP/IP network.

The Modbus/RTU and Modbus/ASCII protocols define how a "master" device polls one or more "slave" devices to read and write real-time data over RS-232, RS-422, or RS-485 serial data communication. The simplicity of Modbus/RTU not only allows rapid implementation, but can also remain flexible enough to be applied in virtually all industrial situations.

During Modbus network communication, the protocol determines how each controller will know its device address, recognize a message addressed to it, determine the kind of action to be taken, and extract any data or other information contained in the message. If a reply is required, the controller will construct the reply message and send it back using Modbus protocol.

The way controllers communicate with each other is by using a master-slave technique, in which only one device (the master) can initiate queries. The other devices (the slaves) respond by supplying the requested data to the master, or by taking the action requested in the query. Typical master devices include host processors and programming panels. Typical slaves include programmable controllers.

It is the master that can address individual slaves and initiate a broadcast message to all slaves. On the other hand, slaves return a response to queries that are addressed to them individually. Responses are not returned to broadcast queries from the master.

The Modbus protocol has a definite format for the master's query, which incorporates the device (or broadcast) address, a function code defining the requested action, any data to be sent, and an error-checking field. The slave's response message, which is also constructed using Modbus protocol, contains fields confirming the action taken, any data to be returned, and an error-checking field. If an error occurred in receipt of the message, or if the slave is unable to perform the requested action, the slave will construct an error message and send it as its response.

The basic system architecture is as below:

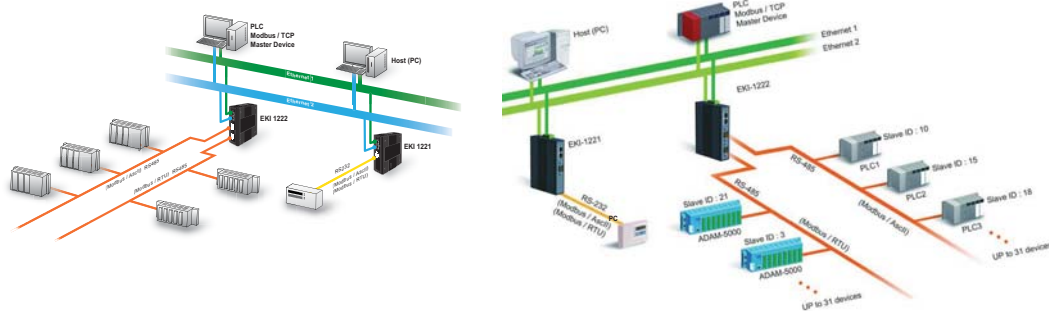

Figure 2.1 Modbus System Architecture 1

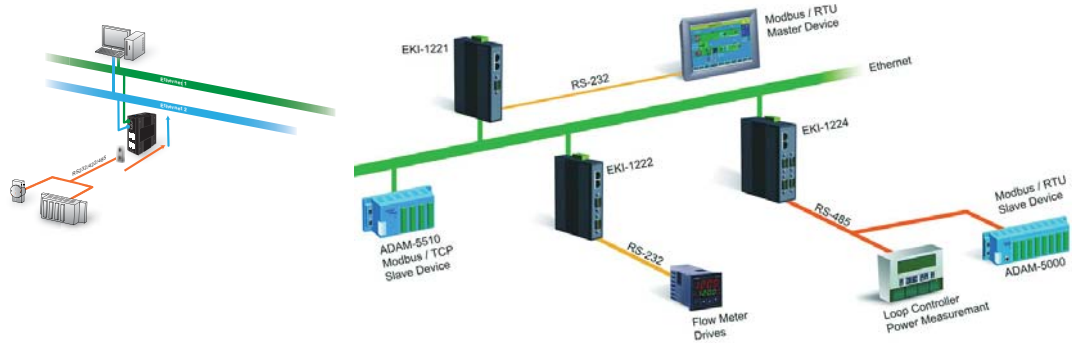

Figure 2.2 Modbus System Architecture 2

2.1.2 Modbus RTU

The Modbus/RTU protocol defines how a “master” device polls one or more “slave” devices to read and write data in real-time over RS-232, RS-422, or RS-485 serial data communication.

When using RTU mode, each 8-bit byte in a message contains two 4-bit hexadecimal characters. The main advantage of this mode is that its greater character density allows better data throughput than ASCII mode for the same baud rate. Nevertheless, each message must be transmitted in continuous stream.

2.1.3 Modbus ASCII

When using ASCII mode, each 8-bit byte in a message is sent as two ASCII characters. The primary advantage of this ASCII mode is that it allows time intervals of up to one second to occur between characters without causing an error.

Mode	RTU	ASCII
Coding System	8-bit binary. Two hexadecimal character contained in each ASCII character of the message	Hexadecimal. One hexadecimal character contained in each ASCII character of the message
Bits per Byte	1 start bit, 8 data bits, 1 bit for even/odd parity; no bit for parity 1 stop bit if parity is used; 2 bits if no parity	1 start bit , 7 data bits, 1 bit for even/odd parity; no bit for parity 1 stop bit if parity is used; 2 bits if no parity
Error Check	CRC	LRC

2.1.4 Modbus ASCII

As a new extension of Modbus/RTU, the Modbus/TCP protocol defines how Modbus/RTU messages are encoded within and transported over TCP/IP-based networks. Modbus/TCP is just as simple to implement and flexible to apply as the original Modbus/RTU. The Modbus/TCP protocol is defined by its form of encapsulation for a Modbus request or response. That means the Modbus request or response data is encapsulated in TCP frame that has a six-byte header in Modbus/TCP protocol.

Modbus/TCP enables the use of Modbus messaging in an Intranet running the TCP/IP protocols. Modbus/TCP is most commonly used for Ethernet attachment of PLC's or I/O modules to other simple field buses or I/O networks.

2.2 Specifications

Specifications	Description	
Interface	I/O Port	<ul style="list-style-type: none"> ■ EKI-1221: 2 x RJ45 + 1 x RS-232/422/485 ■ EKI-1221I: 2 x RJ45 + 1 x RS-232/422/485 ■ EKI-1221CI: 2 x RJ45 + 1 x RS-422/485 ■ EKI-1222: 2 x RJ45 + 2 x RS-232/422/485 ■ EKI-1222I: 2 x RJ45 + 2 x RS-232/422/485 ■ EKI-1222CI: 2 x RJ45 + 2 x RS-422/485 ■ EKI-1224: 2 x RJ45 + 4 x RS-232/422/485 ■ EKI-1224I: 2 x RJ45 + 4 x RS-232/422/485 ■ EKI-1224CI: 2 x RJ45 + 4 x RS-422/485
	Power Connector	Terminal block
Physical	Enclosure	Metal with solid mounting hardware
	Installation	DIN-Rail and Wall mount
	Dimensions (W x H x D)	EKI-1221/1222: 37 x 140 x 95mm (1.46" x 5.51" x 3.74") EKI-1224: 55 x 140 x 95mm (2.17" x 5.51" x 3.74")
LED Display	System LED	Power 1, Power 2, Status
	Port LED	LAN: Speed, Link/Active Serial: Tx, Rx
Environment	Operating Temperature	EKI-1221/EKI-1222/EKI-1224: -10°C ~ 60°C (14°F ~ 140°F) 'CI' & 'I' models: -40°C ~ 70°C (-40°F ~ 158°F)
	Storage Temperature	-20°C ~ 80°C (-4°F ~ 176°F)
	Ambient Relative Humidity	5 ~ 95% RH
Ethernet Communications	Compatibility	IEEE 802.3, IEEE 802.3u
	Speed	10/100 Mbps
	Port Connector	8-pin RJ45
	Protection	Built-in 1.5 KV magnetic isolation

Specifications	Description	
Serial Communications	Port Type	RS-232/422/485, software selectable
	Port Connector	DB9 male
	Data Bits	7, 8
	Stop Bits	1, 2
	Parity	None, Odd, Even, Space, Mark
	Flow Control	XON/XOFF, RTS/CTS, DTR/DSR
	Baud Rate	50 bps ~ 921.6 kbps, any baud rate setting
	Protection	Built-in 15 KV ESD for all signals 'CI' models: 2KV Isolation for RS-422/485 signals
Power	Power Consumption	<ul style="list-style-type: none"> ■ EKI-1221: 5.2W ■ EKI-1222: 5.2W ■ EKI-1224: 6.3W
	Power Input	12 ~ 48V _{DC} , redundant dual inputs
	OS Support	32-bit/64-bit Windows XP/Vista/7/8/8.1, Windows Server 2003/2008/2008 R2/2012/2012 R2, and Linux
Software	Utility	Advantech EKI Device Configuration Utility
	Operation Modes	Modbus RTU Master/Slave mode Modbus ASCII Master/Slave mode
	Configuration	Windows utility, Web Browser
	Management	SNMP MIB-II
	Regulatory Approvals	EMC

2.3 Hardware

2.3.1 Front View

The following view shows the EKI-1221.

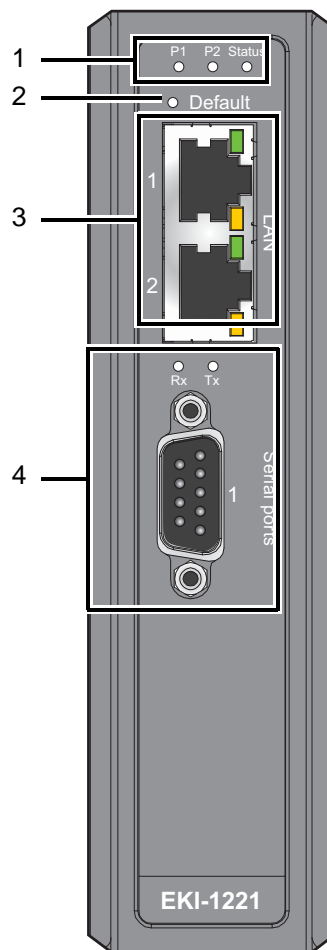

Figure 2.3 Front View

No.	Item	Description
1	System LED panel	See "LED Indicators" on page 13 for further details.
2	Default button	Press for at least 10 secs. to rest device to default settings.
3	ETH port	RJ45 ports x 2
4	Serial port	DB9 pinout, supports 232/422/485

The following view shows the EKI-1222.

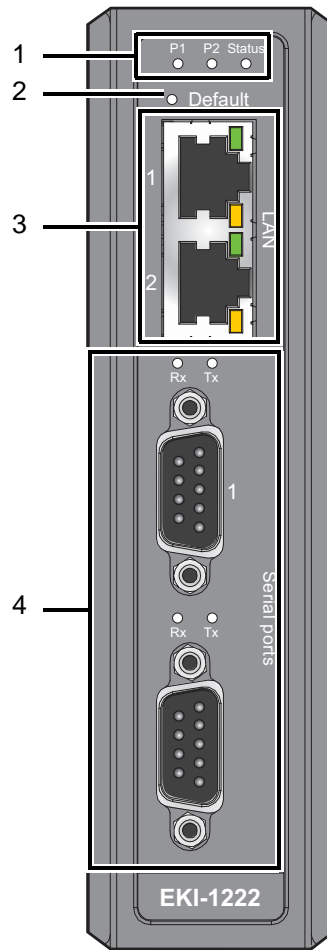

Figure 2.4 Front View

No.	Item	Description
1	System LED panel	See "LED Indicators" on page 13 for further details.
2	Default button	Press for at least 10 secs. to rest device to default settings.
3	ETH port	RJ45 ports x 2
4	Serial port	DB9 (pinout) ports x 2, supports 232/422/485

The following view shows the EKI-1224.

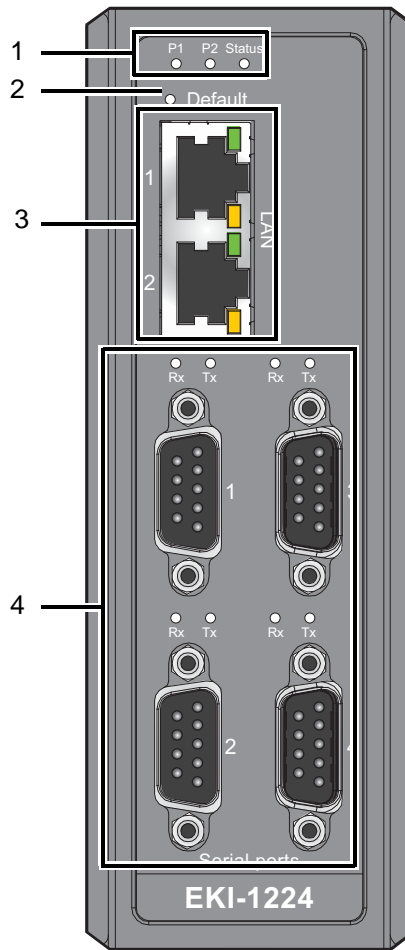

Figure 2.5 Front View

No.	Item	Description
1	System LED panel	See "LED Indicators" on page 13 for further details.
2	Default button	Press for at least 10 secs. to rest device to default settings.
3	ETH port	RJ45 ports x 2
4	Serial port	DB9 (pinout) ports x 4, supports 232/422/485

2.3.2 Rear View

The following view shows the EKI-1221 and EKI-1222.

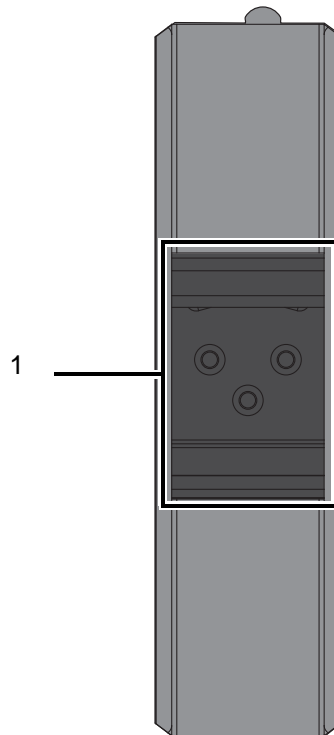

Figure 2.6 Rear View

No.	Item	Description
1	DIN-Rail mounting plate	Mounting plate used for the installation to a standard DIN rail

The following view shows the EKI-1224.

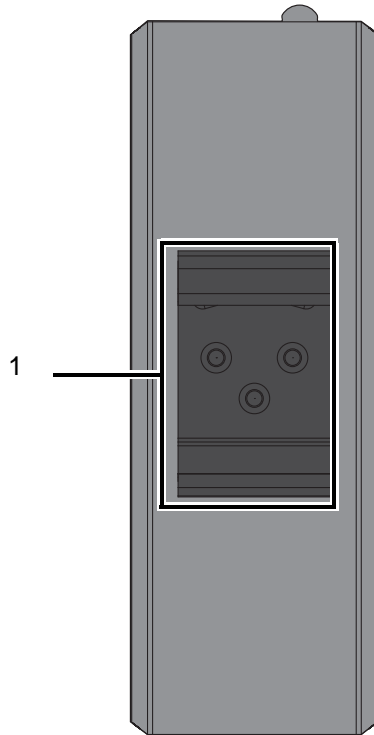

Figure 2.7 Rear View

No.	Item	Description
1	DIN-Rail mounting plate	Mounting plate used for the installation to a standard DIN rail

2.3.3 Top View

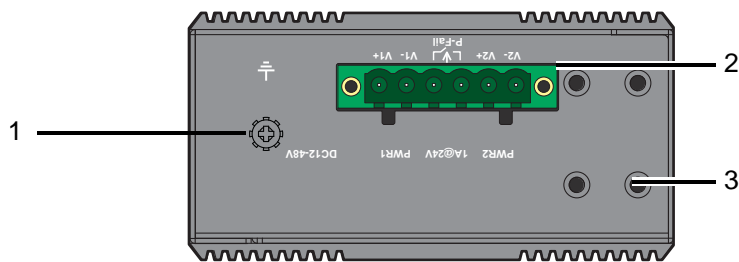

Figure 2.8 Top View

No.	Item	Description
1	Ground terminal	Screw terminal used to ground chassis
2	Terminal block	Connect cabling for power and alarm wiring
2	Wall mounting holes	Screw holes (top x4, bottom x4) used in the installation of a wall mounting plate

2.3.4 LED Indicators

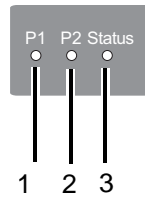

Figure 2.9 System LED Panel

No.	LED Name	LED Color	Description
1	P1	Green	Power 1 is on
		Off	Power 1 is off, or power error condition exists
2	P2	Green	Power 2 is on
		Off	Power 2 is off, or power error condition exists
3	Status	Amber	The device server has been located by utility's location function
		Amber, blinking	System is ready (1cycle/sec.)
		Off	System is not working

2.3.5 Dimensions

The following view shows the EKI-1221 and EKI-1222.

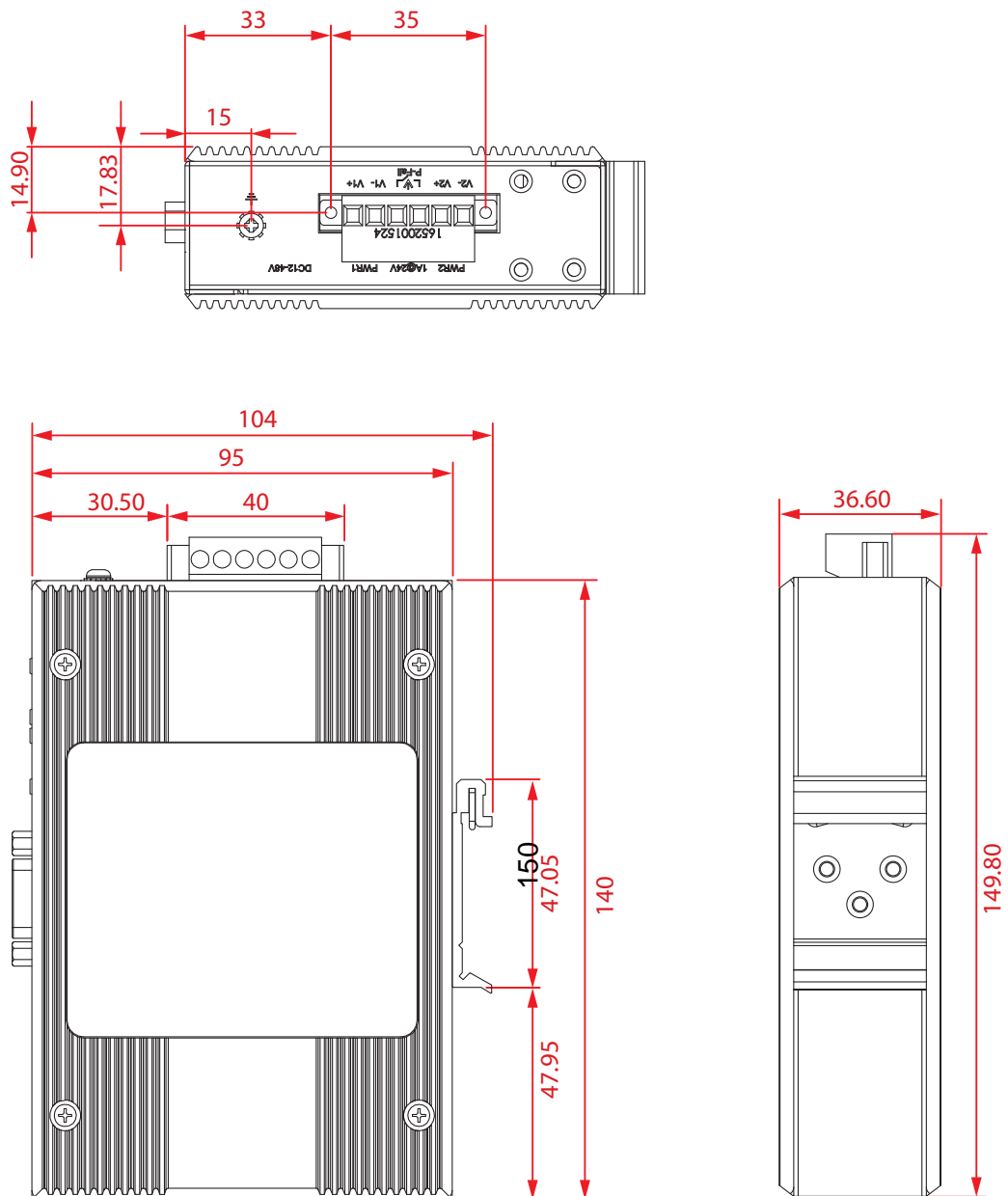

Figure 2.10 EKI-1221 and EKI-1222 Dimensions

The following view shows the EKI-1224.

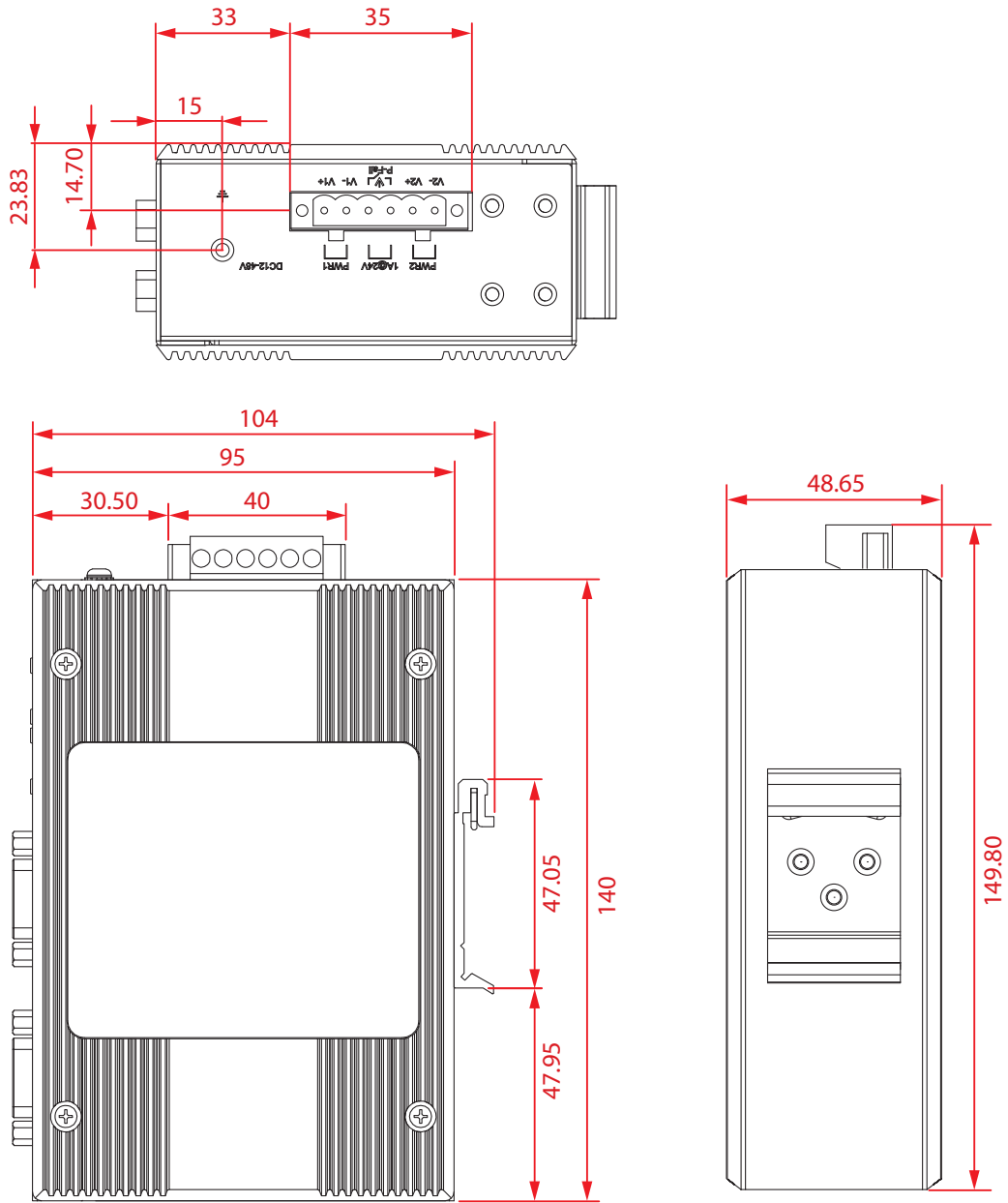

Figure 2.11 EKI-1224 Dimensions

2.4 Connecting Hardware

2.4.1 Choosing a Location

2.4.1.1 DIN Rail Mounting

The DIN rail mount option is the quickest installation option. Additionally, it optimizes the use of rail space.

The metal DIN rail kit is secured to the rear of the serial device server. The device can be mounted onto a standard 35mm (1.37") x 75mm (3") height DIN rail. The devices can be mounted vertically or horizontally. Refer to the following guidelines for further information.

Note! A corrosion-free mounting rail is advisable.



When installing, make sure to allow for enough space to properly install the cabling.

Installing the DIN-Rail Mounting Kit

1. Insert the top back of the mounting bracket over the DIN rail.
2. Push the bottom of the server towards the DIN rail until it snaps into place.

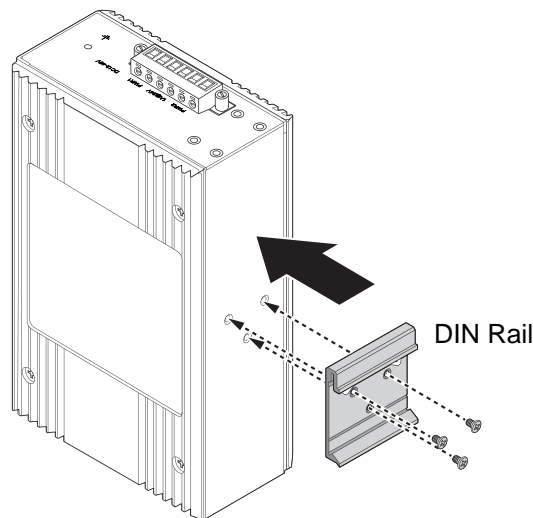

Figure 2.12 Installing the DIN-Rail Mounting Kit

Removing the DIN-Rail Mounting Kit

1. Push the server down to free the bottom of the plate from the DIN rail.
2. Rotate the bottom of the device towards you and away from the DIN rail.

3. Once the bottom is clear of the DIN rail, lift the device straight up to unhook it from the DIN rail.

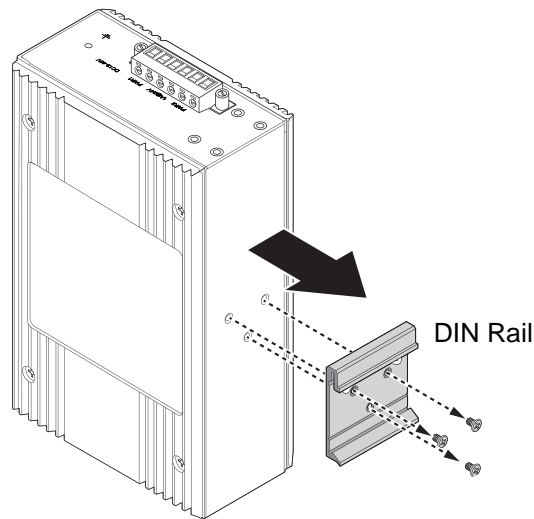

Figure 2.13 Removing the DIN-Rail

2.4.1.2 Wall-Mounting

The wall mounting option provides better shock and vibration resistance than the DIN rail vertical mount.

Note! *When installing, make sure to allow for enough space to properly install the cabling.*



Before the device can be mounted on a wall, you will need to remove the DIN rail plate.

1. Rotate the device to the rear side and locate the DIN mounting plate.
2. Remove the screws securing the DIN mounting plate to the rear panel of the server.
3. Remove the DIN mounting plate. Store the DIN mounting plate and provided screws for later use.
4. Align the wall mounting plates on the rear side. The screw holes on the device and the mounting plates must be aligned, see the following illustration.

5. Secure the wall mount plates with M3 screws, see the following figure.

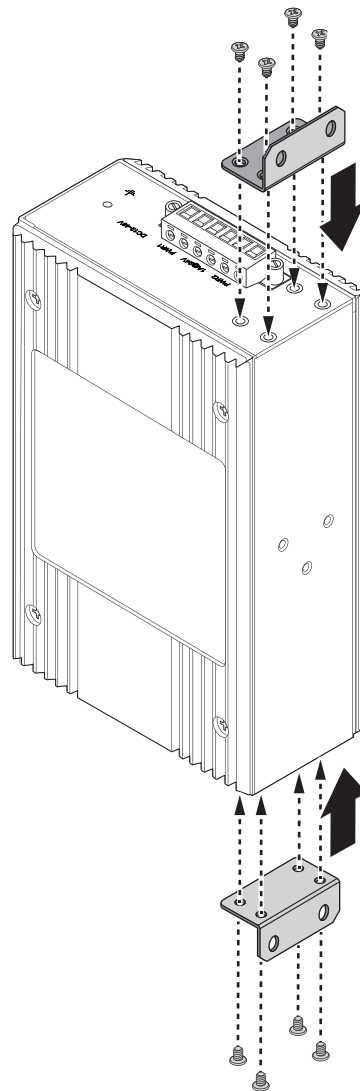

Figure 2.14 Installing Wall Mount Plates

Once the wall mounting plates are secure on the device, you will need to attach the wall screws (x8).

6. Locate the installation site and place the server against the wall, making sure it is the final installation location.
7. Use the wall mount plates as a guide to mark the locations of the screw holes.
8. Drill four holes over the four marked locations on the wall, keeping in mind that the holes must accommodate wall sinks in addition to the screws.
9. Insert the wall sinks into the walls.

10. To mount the wall plate, use screws of the size shown in the following illustration.

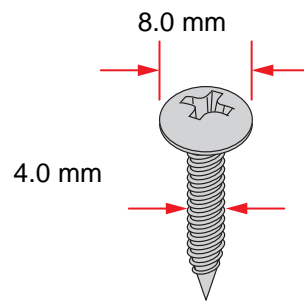

Figure 2.15 Wall Mounting Screw Dimensions

- Note!**
- Make sure the screws dimensions are suitable for use with the wall mounting plate.
 - Do not completely tighten the screws into the wall. A final adjustment may be needed before fully securing the wall mounting plates on the wall.

11. Align the wall mount plate over the screws on the wall.
12. Install the wall mount plate on the screws and slide it forward to lock in place, see the following figure.

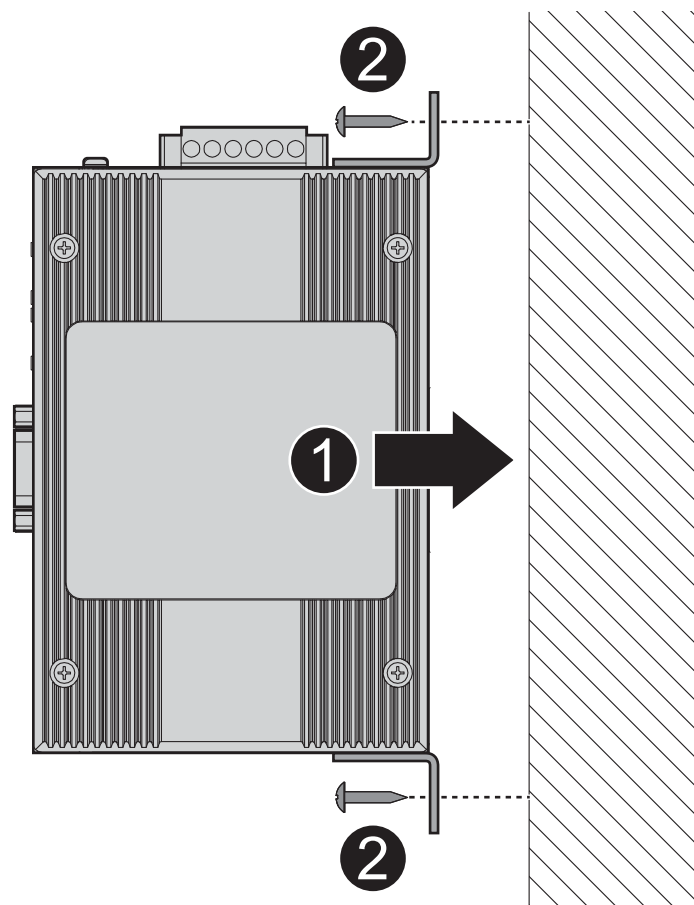

Figure 2.16 Wall Mount Installation

13. Once the device is installed on the wall, tighten the screws to secure the device.

2.4.2 Serial Connection

EKI-122X Series provides up to four ports DB9 (male) connectors. RS-232/422/485 pin assignments as below:

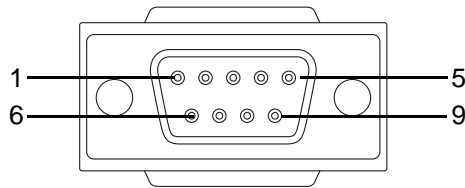

Figure 2.17 DB9 Pin Assignment

Pin	1	2	3	4	5	6	7	8	9
RS-232	DCD	RX	TX	DTR	GND	DSR	RTS	CTS	RI
RS-422	TX-			TX+	GND		RX+		RX-
RS-485	DATA-			DATA+	GND				

2.4.3 Power Connection

2.4.3.1 Overview

Warning! Power down and disconnect the power cord before servicing or wiring the serial device server.



Caution! Do not disconnect modules or cabling unless the power is first switched off.



The device only supports the voltage outlined in the type plate. Do not use any other power components except those specifically designated for the serial device server.

Caution! Disconnect the power cord before installation or cable wiring.



The EKI-122X Series supports dual 12 to 48 VDC power inputs and power-fail relay output.

The following figure illustrates a P-Fail alarm application example. The P-Fail alarm contacts are visible on the front view of the terminal block.

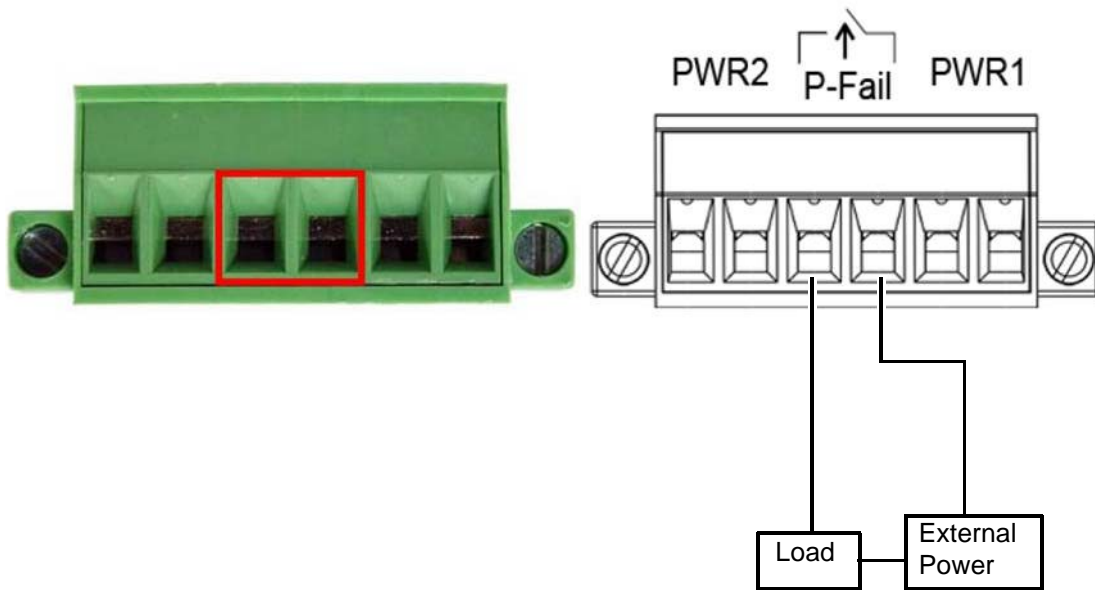

Figure 2.18 Power Wiring for EKI-122X Series

You can connect an alarm indicator, buzzer or other signaling equipment through the relay output. The relay opens if power input 1 or 2 fails. In a wiring example where an LED is connected to the relay output, the LED would be off in an Open state.

Chapter 3

Configuration

3.1 Configuration Utility Overview

Advantech EKI series serial device servers provide an easy-to-use utility to configure your serial device server through an Ethernet connection. For secure administration, it can also restrict the access rights for configuration to only one host PC. With this secure function enabled, other PCs will not have permission for configuration. After the installation program on the Advantech IEDG Series Driver Utility CD-ROM is finished, the serial device servers are ready for use and configuration.

Advantech Serial Device Server Configuration Utility is an excellent device server management tool. You can connect and configure the local and remote Advantech serial device servers easily. The utility provides access to the following functions:

- Configure the network settings (you can set the IP address, Gateway address, and Subnet mask)
- View and set the serial port parameters (configure operating mode, baud rate, serial port settings and operating mode settings)
- Perform diagnostic tests (virtual COM port testing, port status list)
- Perform administrative functions (export and import the serial device server setting, manage access IP, a descriptive name, upgrade firmware)

3.2 Installing the Configuration Utility

Note! *Microsoft .NET Framework version 2.0 or greater is required for this application.*



1. Insert the Advantech EKI Device Configuration Utility CD-ROM into the CD-ROM drive (whereas E:\ is the drive name of your CD-ROM) on the host PC.
2. Use Windows explorer or the Windows Run command to execute the setup program, the path for the setup program on the CD-ROM is as follows:
E:\EKI_Device_Configuration_Utility_v2.01.exe
3. If there is an existing COM port mapping utility on the host PC, remove it at this time. A system reboot may be necessary before continuing the installation.

- Once the InstallShield Wizard screen displays, click **Next** to proceed with the installation.

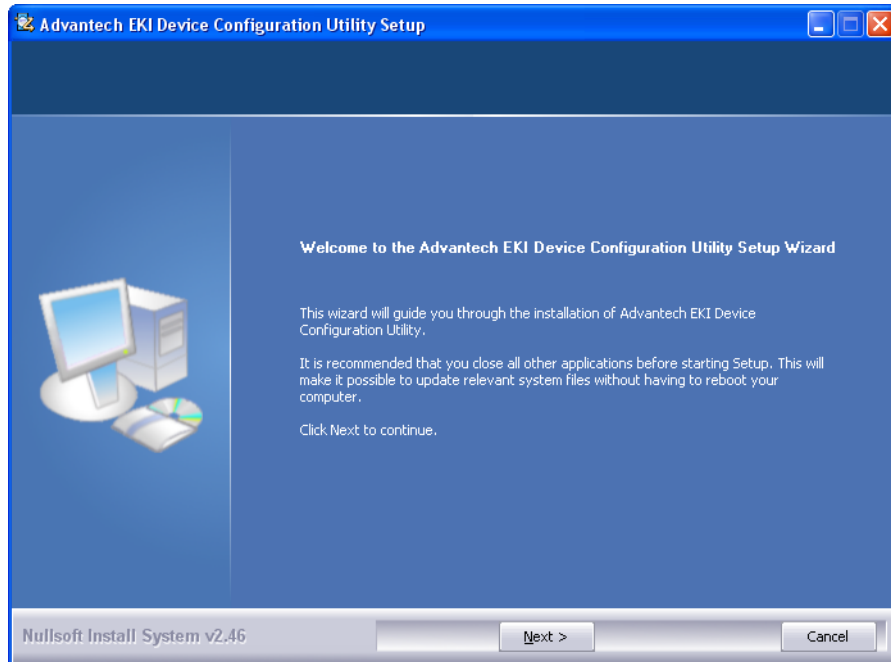

Figure 3.1 InstallShield Wizard 1 of 4

- The Software License Agreement displays, press **I Agree** to continue or **Cancel** to stop the installation.

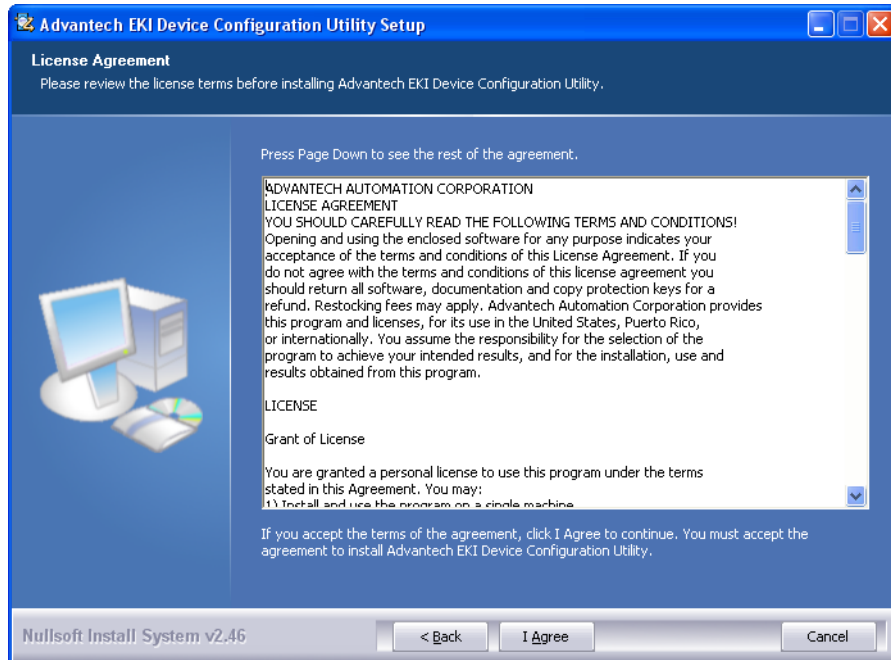

Figure 3.2 InstallShield Wizard 2 of 4

The InstallShield continues and a status screen displays. The default installation path is C:\Program Files\EKI Device Configuration Utility.

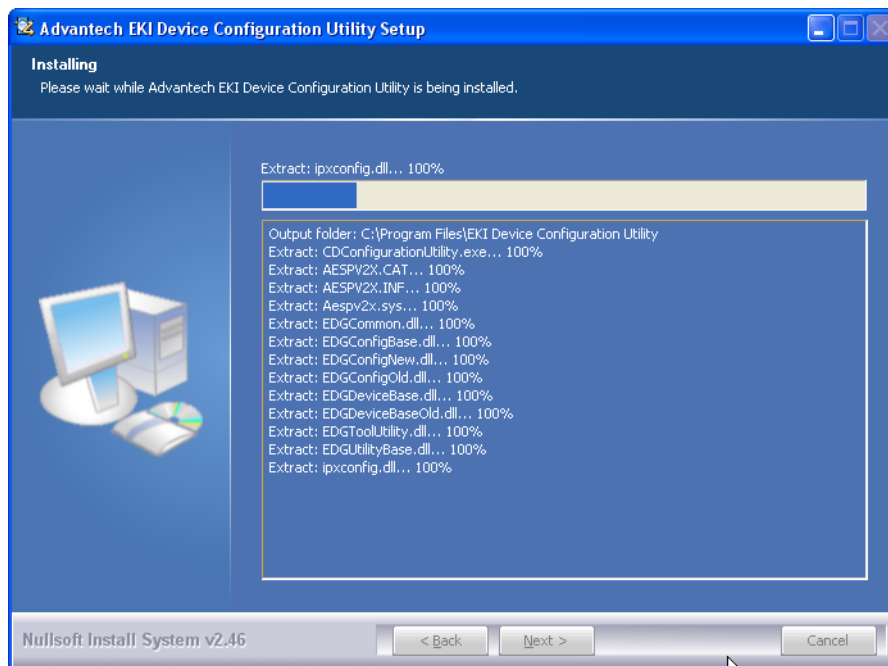

Figure 3.3 InstallShield Wizard 3 of 4

6. Once the installation of the package is finished a Configuration Utility Setup screen displays. Click **Finish** to conclude the process and exit the InstallShield Wizard.

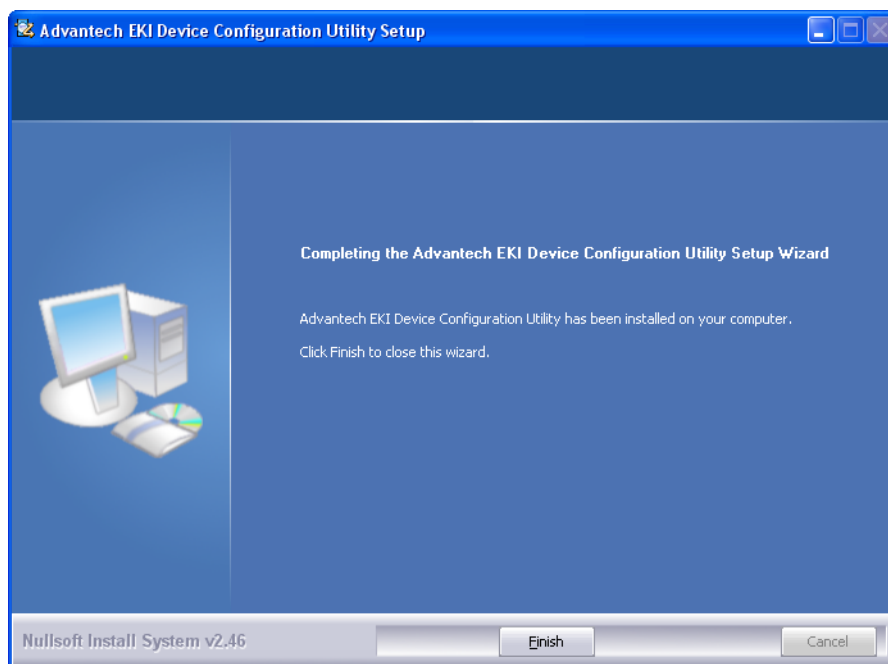

Figure 3.4 InstallShield Wizard 4 of 4

3.3 Menu Bar

You can open the Configuration Utility from the Windows Start Menu by clicking **Start > All Programs > EKI Device Configuration Utility > EKI Device Configuration Utility**. The Configuration Utility displays as shown in the following figure.

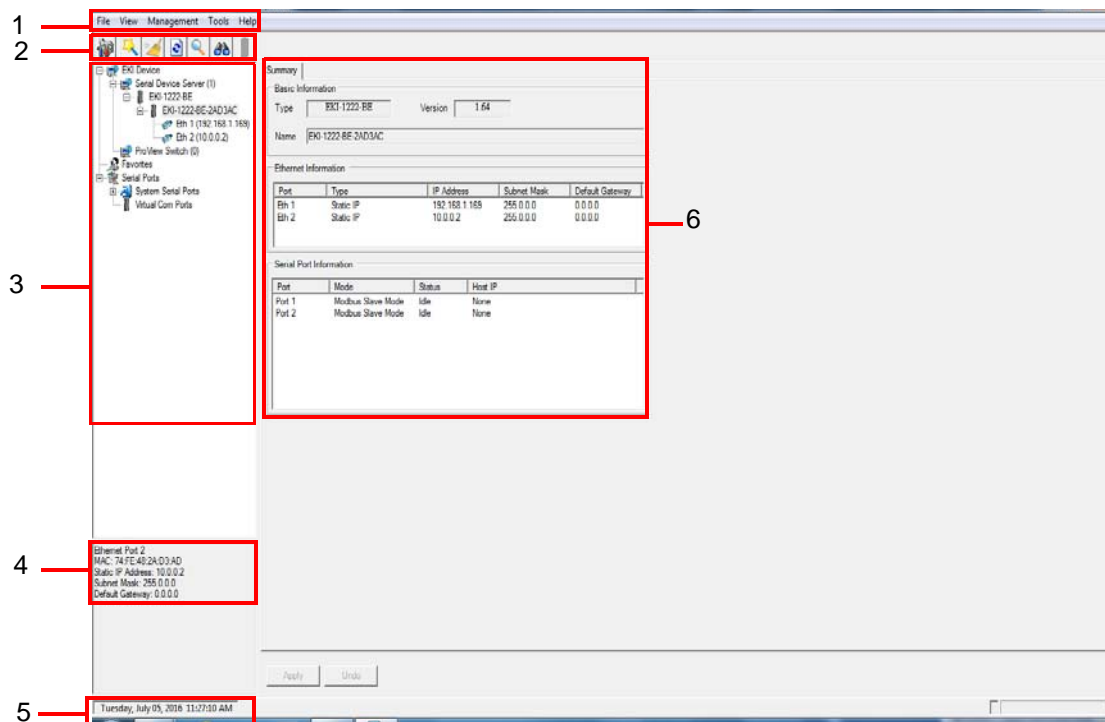

Figure 3.5 Configuration Utility Overview

No	Item	Description
1	Menu Bar	Displays File, View, Management, Tools and Help.
2	Quick Tool Bar	Useful management functions shortcuts.
3	Serial Device Server List Area	Available devices are listed in this area. Devices and COM ports can be organized or grouped in this area.
4	Information Panel	Click on the devices or move cursor to the devices, the related information is shown in this area.
5	Status Bar	Displays the current time.
6	Configuration Area	Click on the item on the Device Server List Area, the configuration page displays.

3.4 Quick Tool Bar

The Advantech EKI Device Configuration Utility makes use of a Quick Tool Bar menu to allow quick access to the management functions. See the following figure for further information.

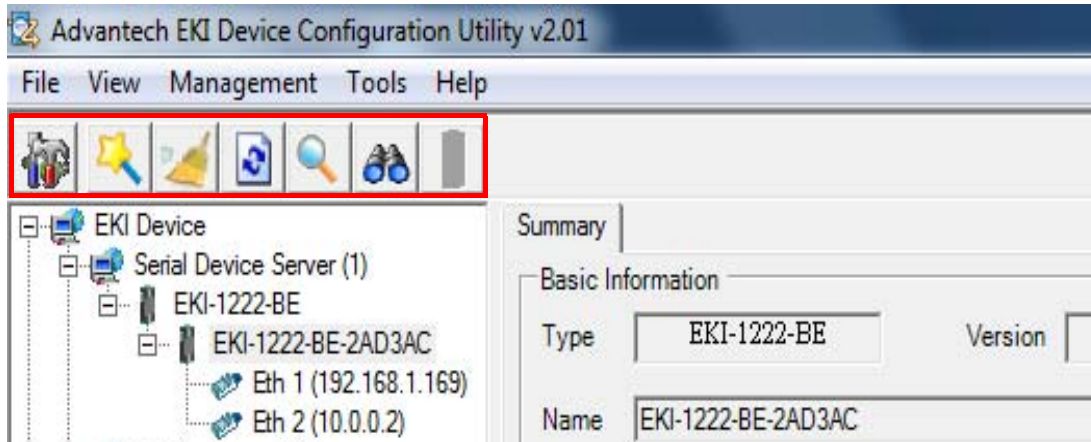









Figure 3.6 Quick Tool Bar Overview

Icon	Item	Description
	Utility Settings	Click to configure the general settings for the Main Form Setting and Device Manager menus. Refer to "Utility Settings" on page 28.
	Configuration Wizard	Start the software wizard (setup assistant) to lead you through the VCOM configuration process for device server product.
	Clear Device List and Search Again	Click to clear listed device servers in the Serial Device Server List Area and initiate a new search. <i>NOTE: A continuous click of the icon results in the following message: Please do not refresh so frequently.</i>
	Search Again	Click to search for serial device servers on the local LAN.
	Add IP Address to Favorite	Click to include the selected IP Address into the Favorites list group.
	Search for a Range of IP Addresses	Click to begin a range search. Enter the beginning and ending IP address to be a search within the string parameters.
	Manual Direct Mapping Virtual COM Port	Click to add a target by selecting the Device Type and inputting the IP address without physically connecting the serial device server to the network.

3.4.1 Utility Settings

3.4.1.1 Main Form Setting

Click **View** > **Settings** to configure utility settings.

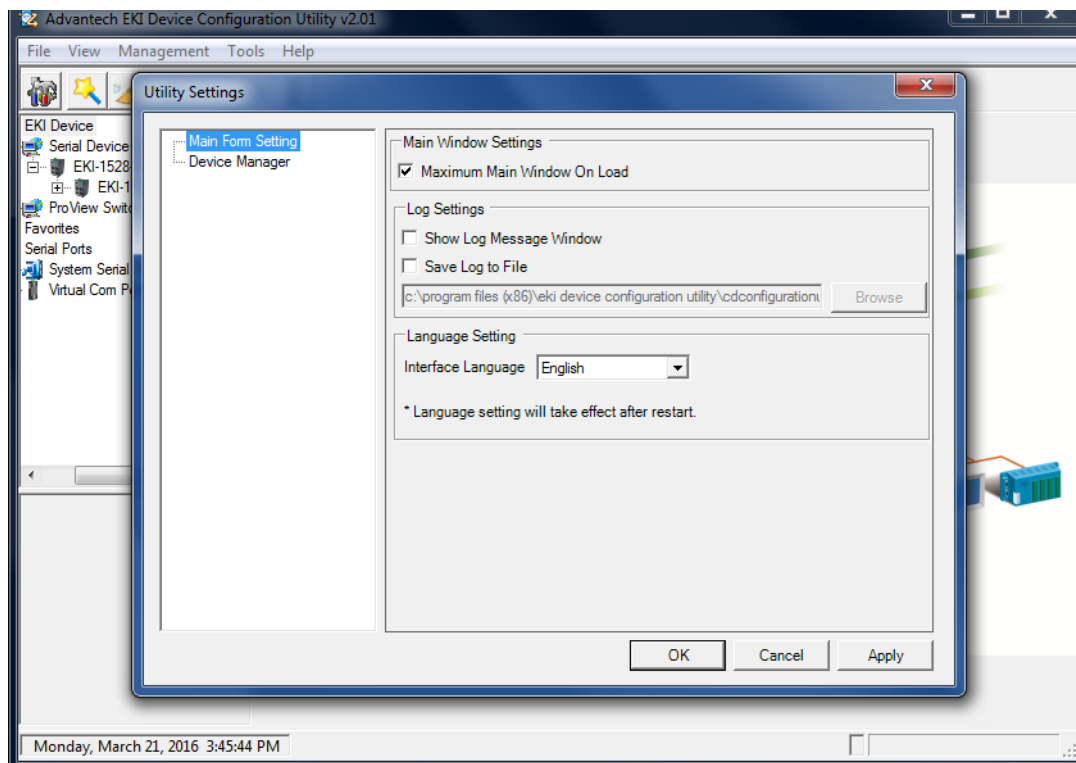

Figure 3.7 View > Settings > Main Form Setting

Item	Description
Main Window Settings	
Maximum Main Window On Load	Check the box to enable the limiting of main windows on-load to the maximum value.
Log Settings	
Show Log Message Window	Check the check box to activate the AdvLogMessage form. The Form Log message displays.
Save Log to File	Check the check box to save log to file.
Browse	If the Save Log to File option is enabled, click Browse to select a file to save log data.
Language Settings	
Interface Language	Click the drop-down menu to select an interface language: Traditional Chinese, Simplified Chinese or English. <i>NOTE: A restart is required for the settings to take effect.</i>
OK	Click OK to save and exit the Utility Settings menu.
Cancel	Click Cancel to discard the changes.
Apply	Click Apply to save the main form settings.

3.4.1.2 Device Manager

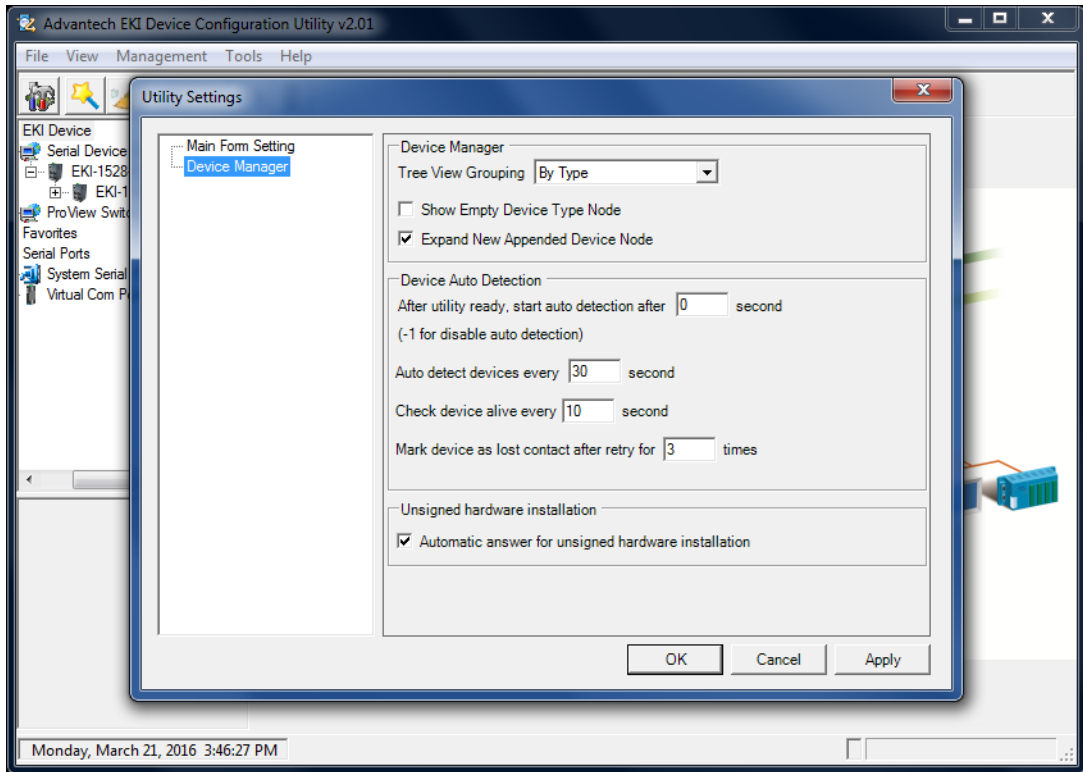

Figure 3.8 View > Settings > Device Manager

Item	Description
Device Manager	
Tree View Grouping	Click the drop-down menu to enable or disable grouping.
Show Empty Device Type Node	Check the check box to show empty device type node or not.
Expand New Appended Device Node	Check the check box to expand a new appended device node.
Device Auto Detection	
After utility ready, start auto detection after X second	Enter a value to specify the time to auto detection time (-1 means disable auto detection).
Auto detect devices every X second	Enter a value to specify the time to auto detect devices.
Check device alive every X second	Enter a value to specify the time to check device alive.
Mark device as lost contact after retry for X times	Enter a value to specify the time to mark device as lost contact.
Unsigned Hardware Installation	
Automatic answer for unsigned hardware installation	Check the check box to enable or disable answer automatically for unsigned hardware installation.
OK	Click OK to save and exit the utility setting.
Cancel	Click Cancel to discard the changes.
Apply	Click Apply to save the utility setting.

3.4.2 Discovering Your Device Server

3.4.2.1 Auto Searching

Advantech Serial Device Server Configuration Utility will automatically search all the EKI-122X Series device servers on the network and show them on the Serial Device Server List Area of the utility. The utility provides an auto-search function to show your device (s) by simply executing the configuration utility program from the Start Menu.

From here all devices on the same network domain will be searched and displayed on Device Server List Area. You can click on a device name to show the features of the specific device.

Click on the “+” before the model name, and the utility will expand the tree structure to show the individual device name. Click on the “-” before the model name, and the utility will collapse the tree structure.



Figure 3.9 Open View of Serial Device Configuration Utility

In the previous figure, the EKI serial device server is listed as EKI-1222-BE-2AD3AC.

Note! *When you run the configuration utility for the first time, the default device name is obtained from the serial device’s MAC identification number. The name can be altered through the configuration utility.*



Select the device in this sub-tree. The first tab on the Configuration Area shows the summary of “Basic Information” included device type, version, and name, “Ethernet

Information”, and “Serial Port Information”. In the serial port information frame, it displays the operation mode, status and connected host IP.

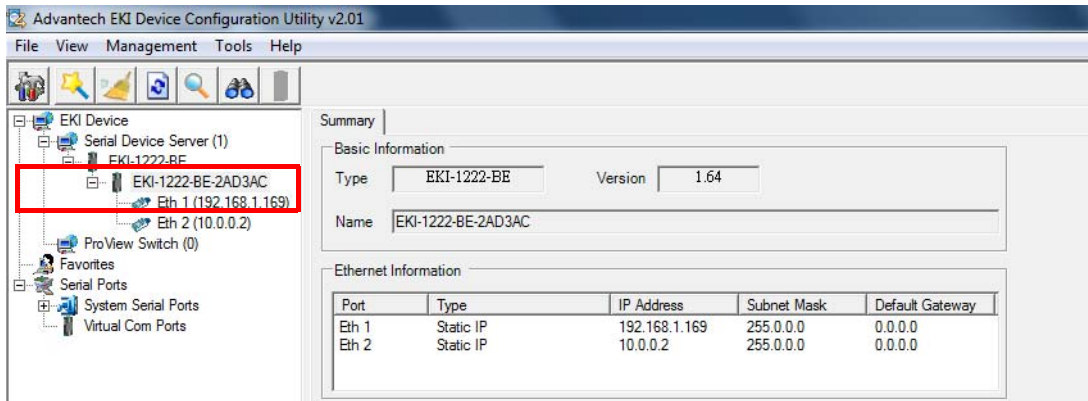

Figure 3.10 Selecting a Group

Click on the “+” before the device name, and the utility will expand the interfaces on this device server.

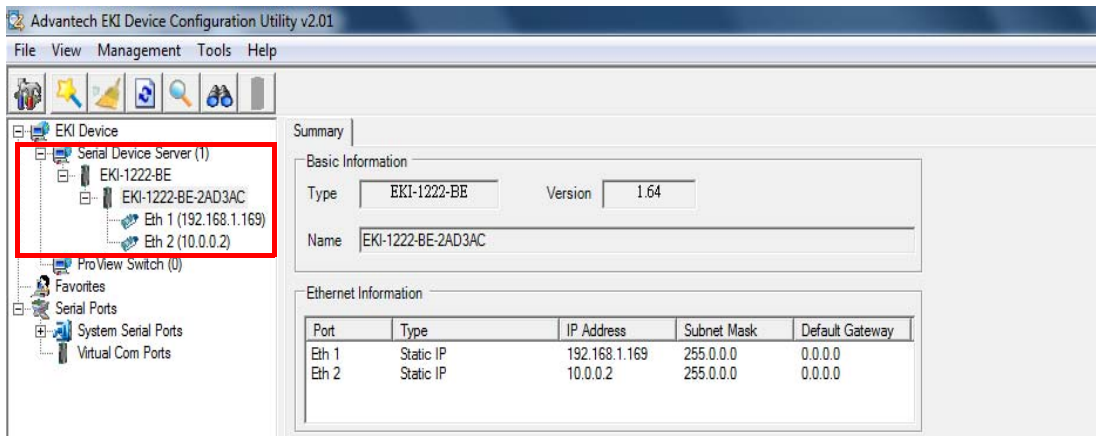

Figure 3.11 Selecting a Device

Click on each item to enter the configuration page to change the setting. The configuration will be introduced on following sections.

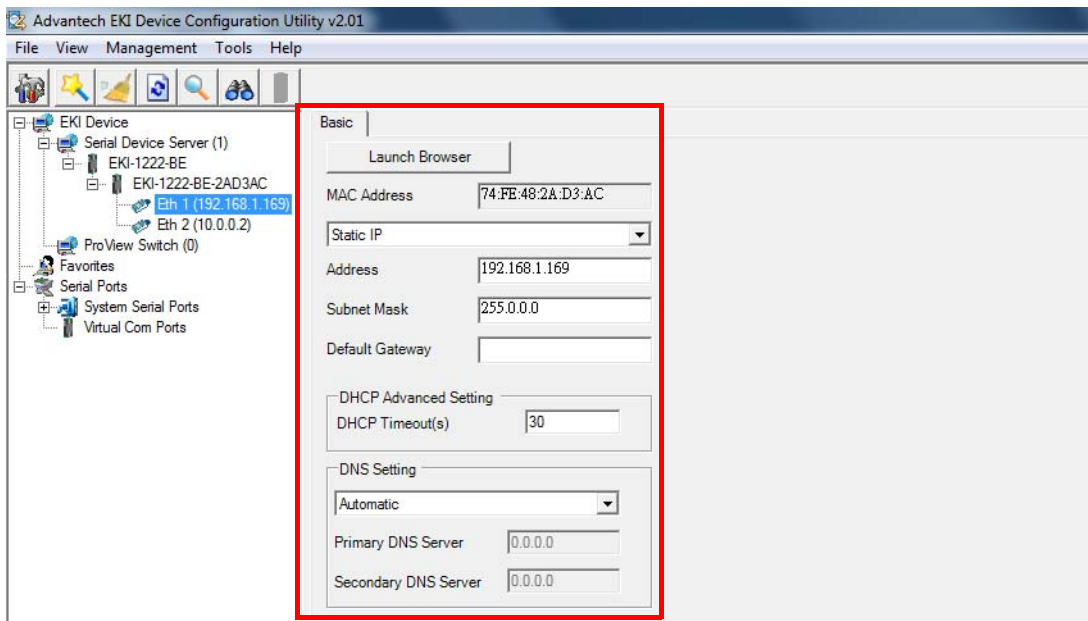

Figure 3.12 Viewing Basic Settings

3.4.3 Network Settings

This section explains how to configure the EKI-122X Series network settings using the configuration utility to allow it to a serial device over a network connection.

Click on the “+” before the model name (e.g. EKI-1222) to expand the device’s sub-menu listing. Click on the “+” before the device name, and the utility expands the interfaces on the device server.

Select the Ethernet interface (Eth1 or Eth2) to view the settings and modify them.

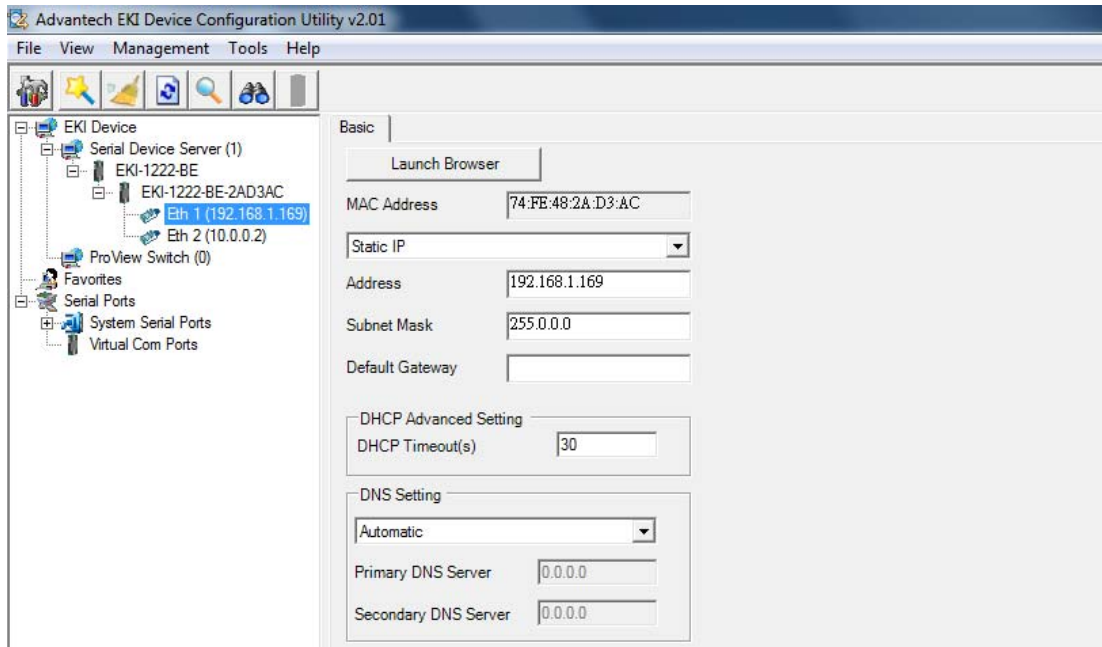

Figure 3.13 Utility Overview

You can choose from four possible IP Configuration modes --- Static, DHCP, BOOTP, and DHCP/BOOTP.

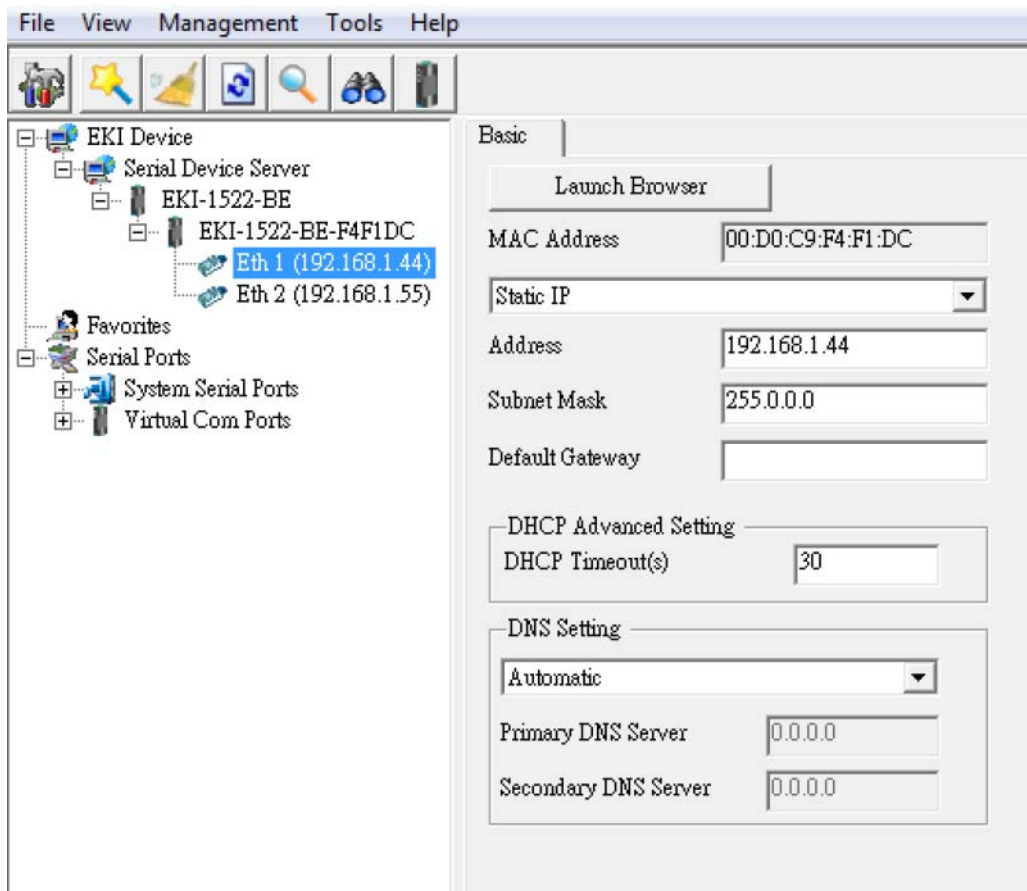



Figure 3.14 Network Settings Overview

Item	Description
Static IP	Static IP User defined IP address, Subnet Mask, and Default Gateway.
DHCP + Auto-IP	DHCP Server assigned IP address, Subnet Mask, Default Gateway, and DNS.
BOOTP + Auto-IP	BOOTP Server assigned IP address.
DHCP + BOOTP + Auto-IP	DHCP Server assigned IP address, Subnet Mask, Default Gateway, and DNS, or BOOTP Server assigned IP address. (If the DHCP Server does not respond)
DNS Setting	In order to use DNS feature, you need to set the IP address of the DNS server to be able to access the host with the domain name. The EKI serial device server provides Primary DNS Server and Secondary DNS Server configuration items to set the IP address of the DNS server. Secondary DNS Server is included for use when Primary DNS server is unavailable.
DHCP Advanced Setting	When you enabling DHCP protocol to get IP address, it will be waited DHCP server to give IP within DHCP time out. The default value is 180 seconds.

Note!  When you have finished the configuration of these settings for each category, please press the “Apply” button in order to make these settings effective on the Serial Device Server.

Click **Reboot** to reboot the serial device server. Any configuration changes you have made since the last time you saved will be lost.

To reset the device:

1. Right-click a desired device to display the settings menu.
2. Select **Reset Device**.

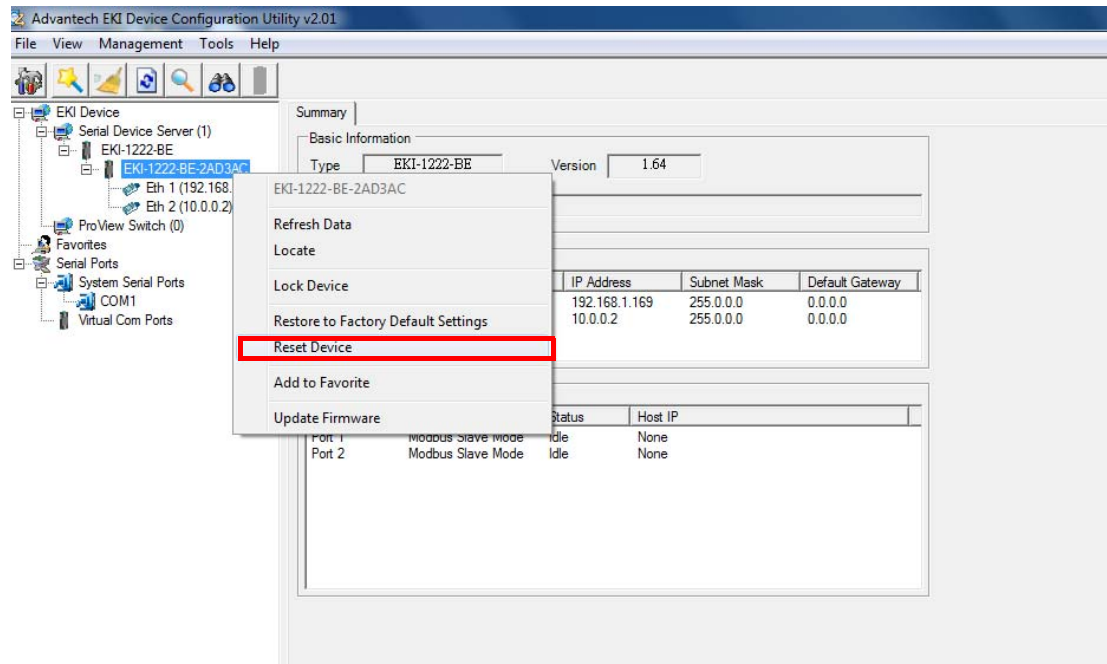

Figure 3.15 Reset Device

3.5 Administrator Settings

3.5.1 Locate the Serial Device Server

When several serial device servers are connected to the network, identification of a specific serial device is possible through the Locate function.

To locate the serial device server:

1. From the device list frame, locate the desired device and right-click on it to display the settings menu.
2. Select **Locate** from the menu.

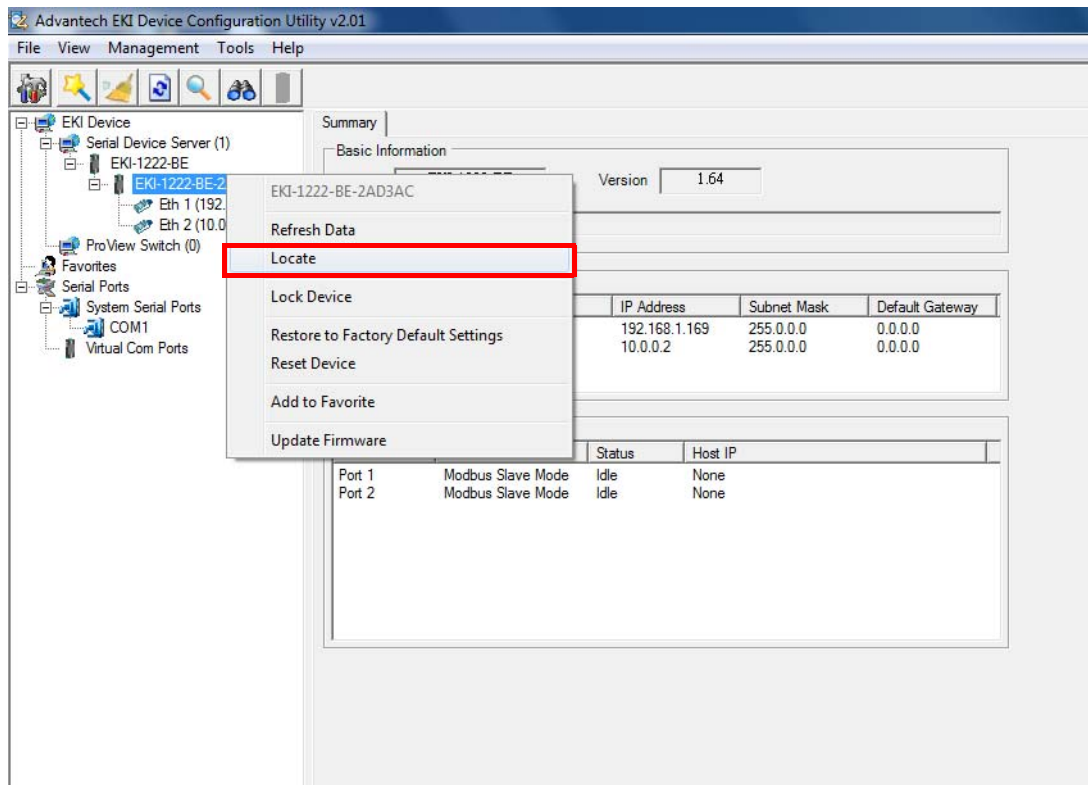

Figure 3.16 Locate the Serial Device Server

The unit's Status LED solid amber and the buzzer beep until you click **Stop Locate**.

3.5.2 Securing the Serial Device Server

3.5.2.1 Lock the Serial Device Server

The configuration utility provides a “Lock Device” function to make it more secure.

To lock the serial device server:

1. Right-click a desired device to display the settings menu.
2. Select **Lock Device**.

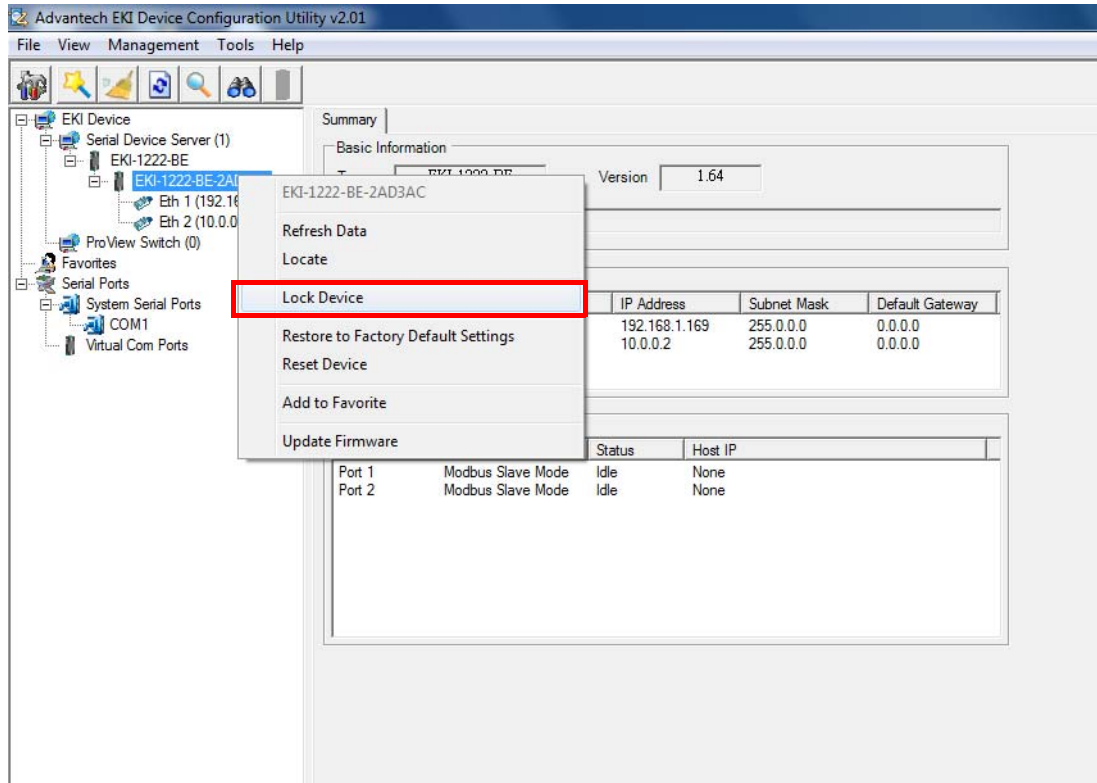

Figure 3.17 Lock the Serial Device Server

3. Enter a password. Retype the password entry to confirm the profile password.

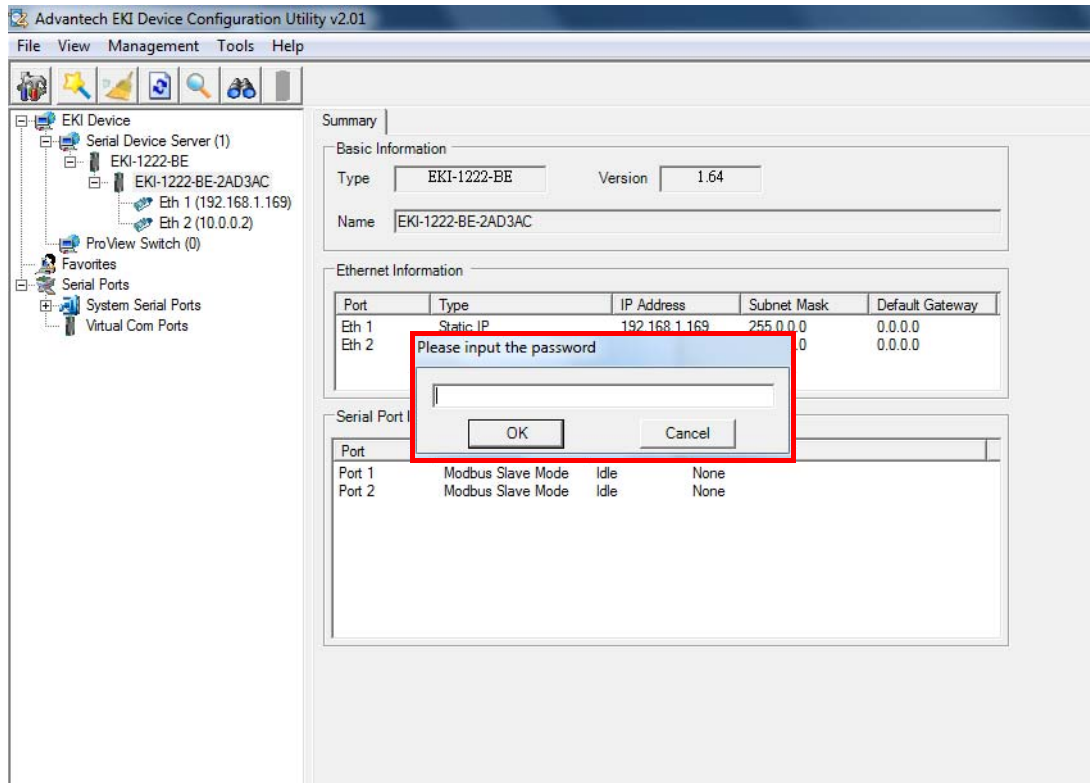

Figure 3.18 Enter a Password

4. Right-click a desired device to display the settings menu. Select **Reset Device** to restart the serial device server and store your setting password into the memory.

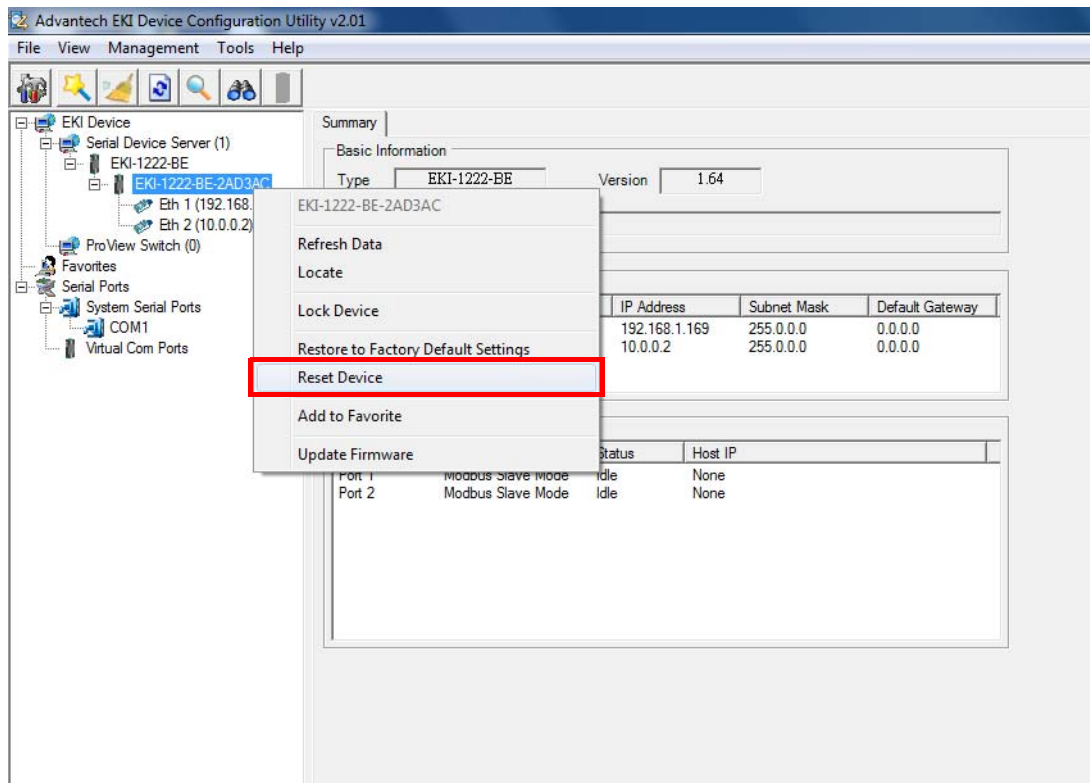

Figure 3.19 Reset Device

3.5.2.2 Unlock the Serial Device Server

To unlock the serial device server:

1. Right-click a desired device to display the settings menu.
2. Select **Unlock Device**.

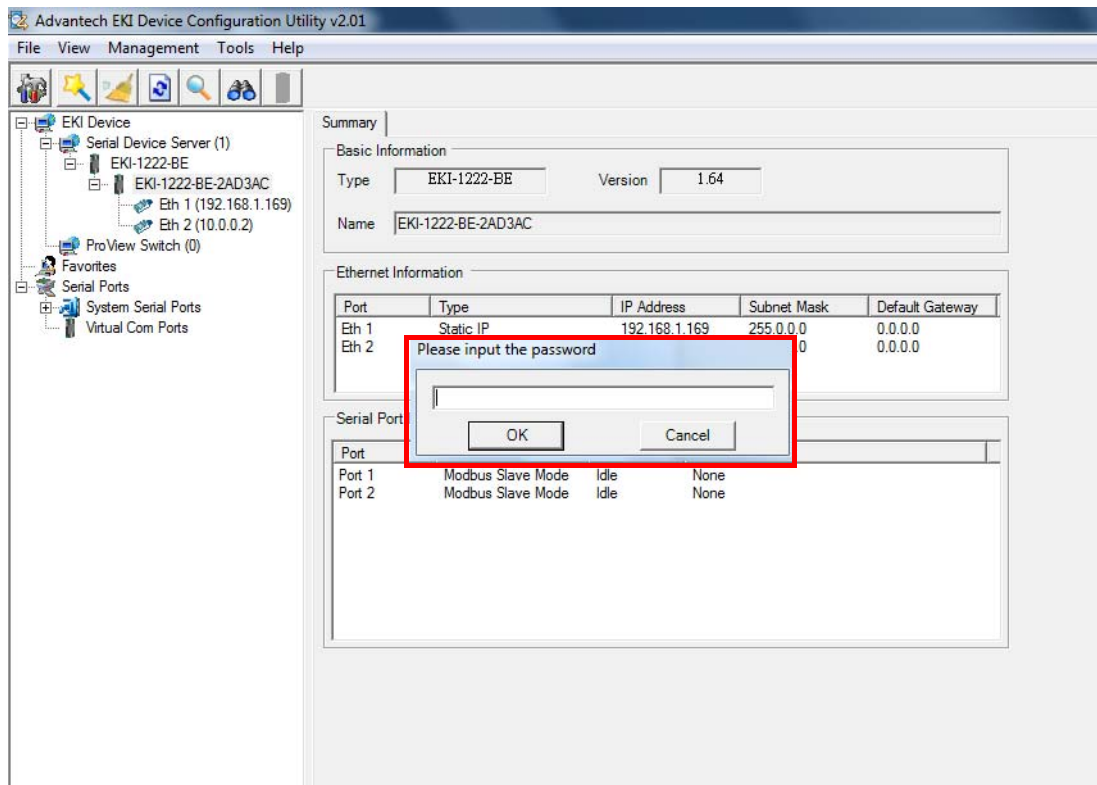

Figure 3.20 Unlock the Serial Device Server

3. Enter the password as entered in the Lock Device procedure.
If you forgot the password, you must restore the setting of the serial device server to the factory defaults, which will be introduced in the next section.

3.5.3 Restore to Factory Default Settings

The configuration utility provides the function to restore the serial device server to factory default settings.

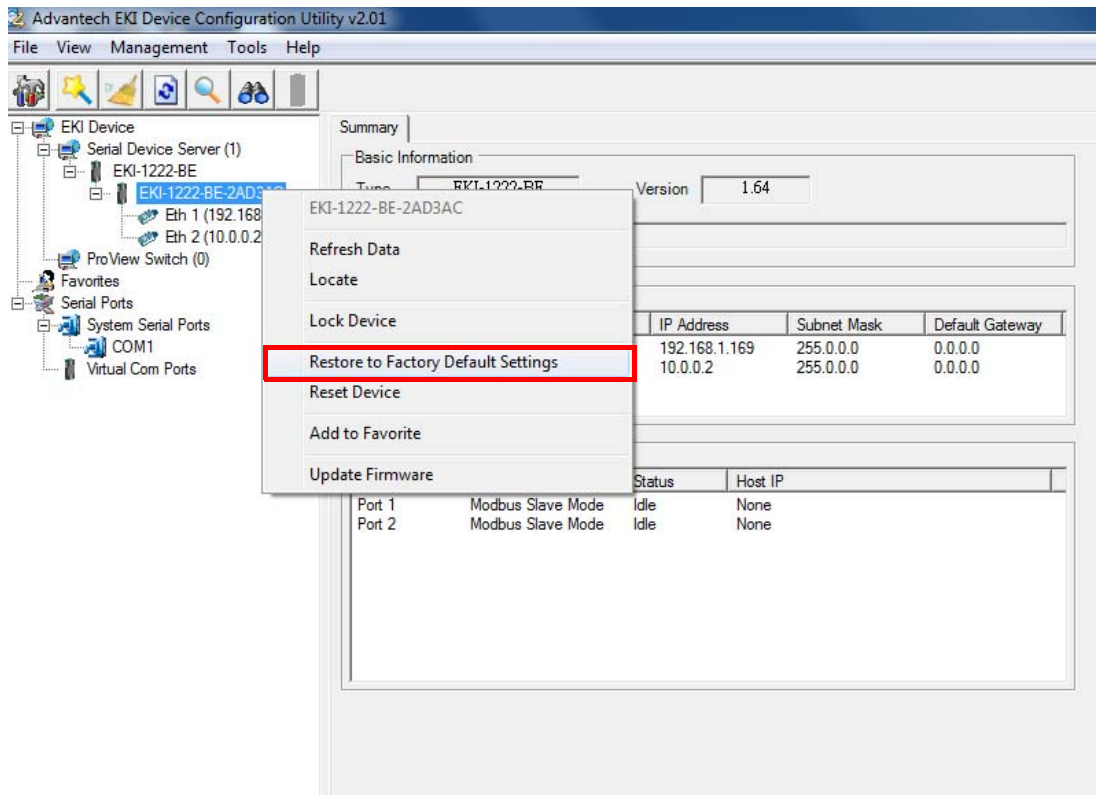

Figure 3.21 Restore to Factory Default Settings

The confirm message will display after clicking **Restore to Factory Default Settings**. If you really want to restore the serial device server to factory default settings, click **Yes** button to continue.

Power off the serial device server within ten seconds. After reconnecting the power, all settings will be reset to the factory default. If the power supply remains connected for more than ten seconds, the serial device server will not be changed.

3.5.4 Resetting the Device

The **Reset Device** function allows you to reset the serial device server. The function disconnects both the ethernet and serial connections.

The function also allows the serial device server to save new configuration settings to flash memory. Once a new setting is changed, you can use the Save function to accept the changes. You must then reset the device to save the settings to flash memory.

To access this page, click **Tools > Reboot**.

Click **Reboot** to reboot the serial device server. Any configuration changes you have made since the last time you saved will be lost.

To reset the device:

1. Right-click a desired device to display the settings menu.
2. Select **Reset Device**.

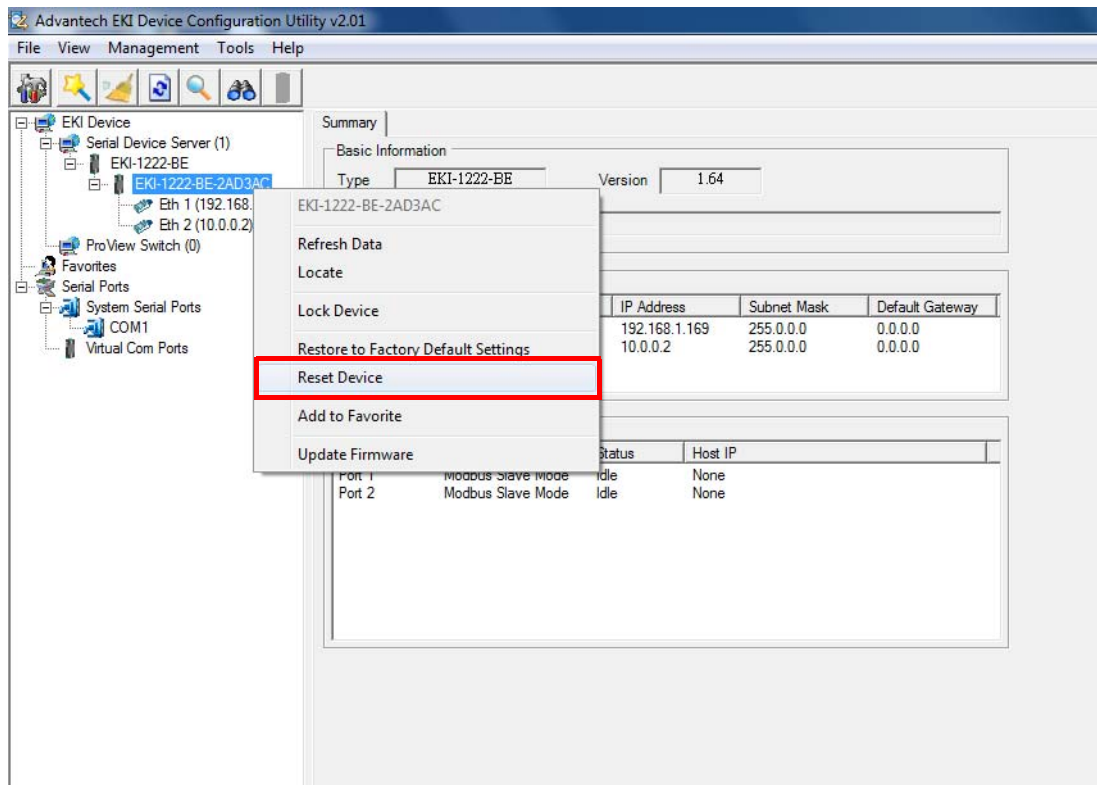

Figure 3.22 Reset Device

The device resets. Once the process is complete, the serial device server displays under the Serial Device Server listing once again.

3.5.5 Add to Favorite

The Add to Favorite function allows to easily map available devices to Favorites. By bookmarking specific devices, you can create quickly accessible shortcuts for existing critical devices from the vast pool of locally or remotely networked EKI devices.

3.

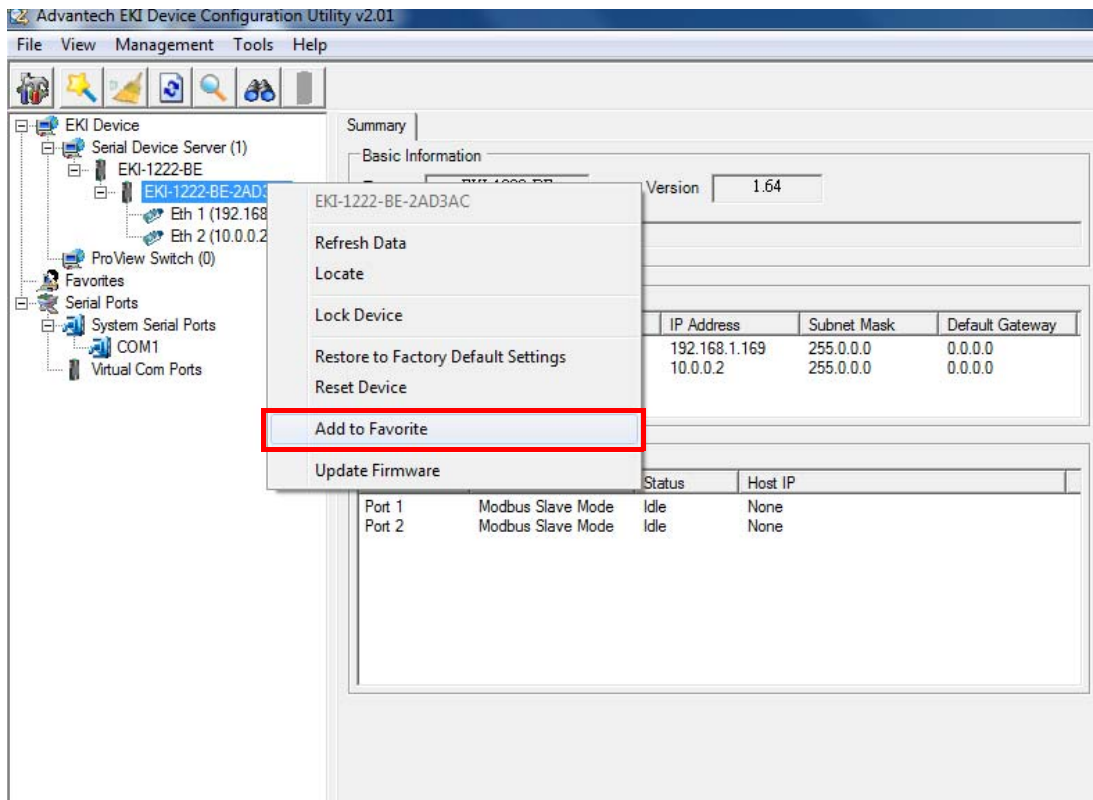

Figure 3.23 Add to Favorite

3.5.6 Update Firmware

Advantech continually upgrades its firmware to keep up with the ever-expanding world of computing. You can use the update firmware function in the utility to carry out the upgrade procedure. Please access Advantech's website: <http://www.advantech.com> to download the latest version of the firmware. Before updating the firmware, make sure that your host's Network domain is as same as the serial device server or the host can establish the TCP connection to the serial device server.

To update firmware:

1. Right-click a desired device to display the settings menu.
2. Select **Update Firmware**.

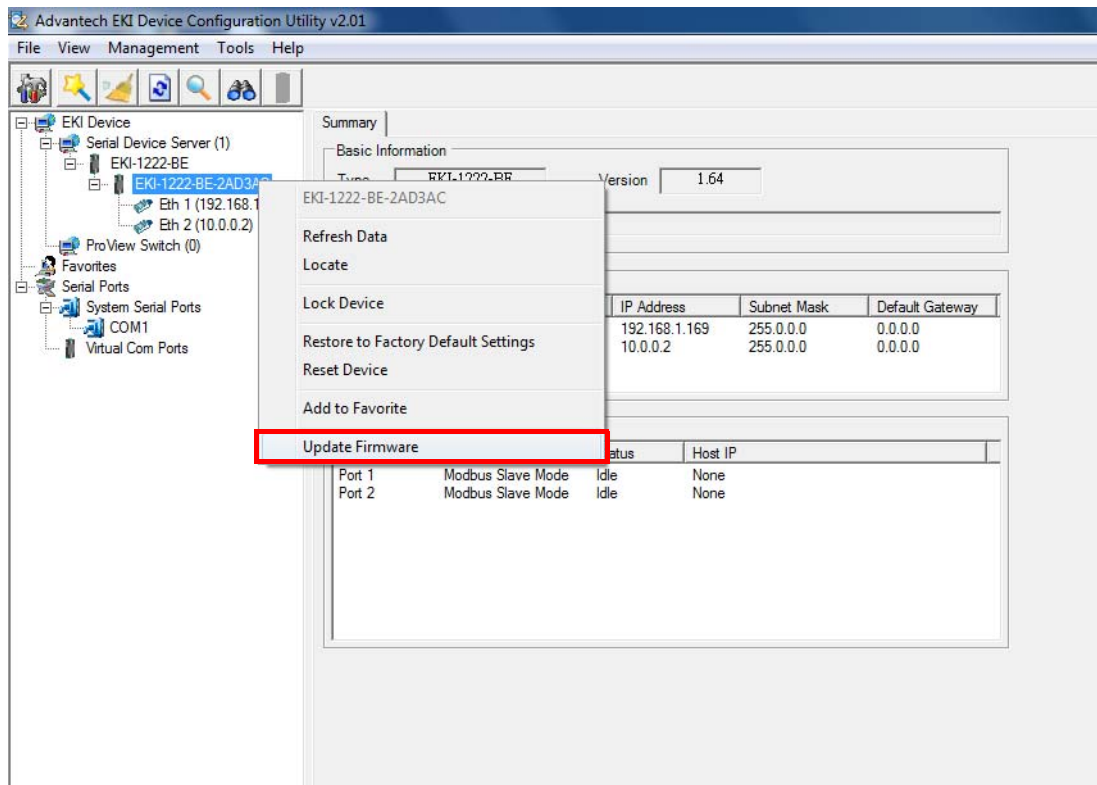

Figure 3.24 Update Firmware

3. Select the firmware file you want to update.

Wait for a few seconds for the firmware to finish updating. After the update has completed, click on the **OK** button. The serial device server will restart automatically.

Note!



Be sure that the host PC Ethernet network domain is as same as the EKI-122x Series serial device server or the host PC can establish the TCP connection with the serial device server while doing the updating firmware process.

Chapter 4

Web Interface

4.1 Overview

An EKI modbus gateway can be configured through a web interface. By using a standard web browser, the same procedure as with the Windows configuration utility can be used. In the browser's address field, enter the IP Address of your EKI serial device server. The default IP setting is 10.0.0.1, but you should use the IP which you have previously assigned for this device. Once the IP is entered, you will be presented with the following windows.

Note! *Before using the web-based configuration, make sure your host PC Ethernet network IP domain is as same as the serial device server, or it can establish the TCP connection with the serial device server.*



Note! *It is recommended that you use Microsoft Internet Explorer 7.0 or higher.*



4.2 Accessing the Web Page

4.2.1 Accessing the Web Page via Configuration Utility

To access the web page via configuration utility:

1. Select Ethernet under the desired device.
2. Click **Launch Browser**.

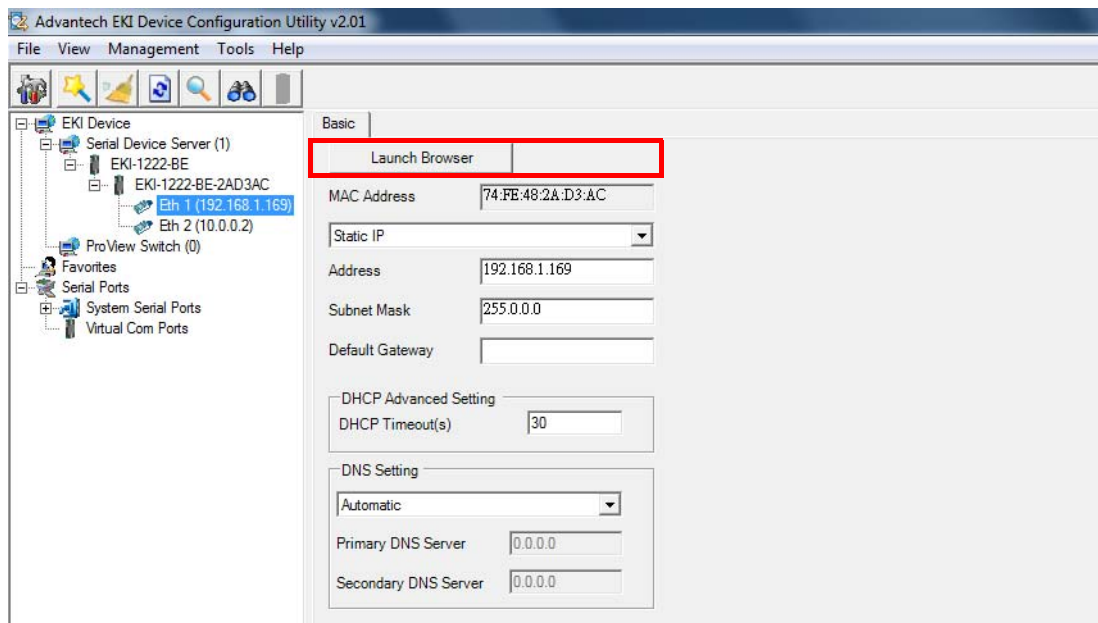

Figure 4.1 Accessing the Web Page via Configuration Utility

4.2.2 Accessing the Web Page via Web Browser

Once the device is installed and connected, power on the device. The following information guides you through the logging in process.

1. Launch your web browser on the PC.
2. In the browser's address bar, type the device's default IP address (Eth1: 10.0.0.1, Eth2: 10.0.0.2).
The main interface displays.

4.3 System

You can change the Device Name and Device Description on this page. You can also enable or disable the Telnet and SNMP functions. You can also modify the Timezone settings.

To access this page, click **System**.

System Configuration	
Firmware version:	1.66
Revision number	4666
Device Name	<input type="text"/>
Device Description	<input type="text"/>
Telnet	<input type="radio"/> Disable <input checked="" type="radio"/> Enable
SNMP	<input type="radio"/> Disable <input checked="" type="radio"/> Enable
Local Time	2016 / 8 / 9 10 : 13 : 0 Modify
Time Server	<input type="text"/>
Modbus Settings	
Listen Port for Slave Mode	<input type="text" value="502"/>
<input type="button" value="Save"/>	

Figure 4.2 Setting Time Zone

The following table describes the items in the previous figure.

Item	Description
Firmware version	Displays the current firmware version of the device.
Revision number	Displays the revision number of the device.
Device Name	Enter the device name: up to 31 alphanumeric characters.
Device Description	Enter the device description.
Telnet	Click Enabled or Disabled to set remote access through the Telnet Service function.
SNMP	Click Enabled or Disabled to define the SNMP daemon.
Local Time	Click Modify to set local date and time of the system.
Time Server	Enter the address of the SNTP server. This is a text string of up to 64 characters containing the encoded unicast IP address or hostname of a SNTP server. Unicast SNTP requests will be sent to this address. If this address is a DNS hostname, then that hostname should be resolved into an IP address each time a SNTP request is sent to it.
Listen Port for Slave Mode	Enter a value to identify the channel for remote initiating connections. The default value is 502.
Save	Click Save to save the values and update the screen.

4.4 Ethernet Configuration

Choose either **Eth 1** or **Eth 2** in the Ethernet Configuration page. Enter the corresponding values for your network environment. Remember to press **Save** after entering all values.

To access this page, click **Ethernet Configuration**.

The screenshot shows the 'Eth1 Configuration' page. It features a table with the following fields and values:

Eth1 Configuration	
Mode	Static IP
MAC Address	74-FE-48-04-FF-AB
IP Address	192.168.1.167
Subnet Mask	255.255.255.0
Default Gateway	192.168.1.1
DNS	<input checked="" type="radio"/> Automatic <input type="radio"/> Specific
Current Status	
IP 1	192.168.1.167
IP 2	fe80::76fe:48ff:fe04:ffab

At the bottom of the form is a 'Save' button.

Figure 4.3 Ethernet Configuration

The following table describes the items in the previous figure.

Item	Description
IPv4 Configuration	
Mode	Click the drop-down menu to select the IP Address Setting mode: Static or DHCP.
MAC Address	Enter the MAC address to which packets are statically forwarded.
IP Address	Enter a value to specify the IP address of the interface. The default is 192.168.1.1.
Subnet Mask	Enter a value to specify the IP subnet mask for the interface. The default is 255.255.255.0.
Default Gateway	Enter a value to specify the default gateway for the interface. The default is 192.168.1.254.
DNS	Click the radio button to select the DNS mode: Automatic or Specific.
IP 1	Displays the current IP address 1 of the device.
IP 2	Displays the current IP address 2 of the device.
Save	Click Save to save the values and update the screen.

Note! All new configurations will take effect after rebooting. To reboot the device, click **Tools > Reboot**.



4.5 Port Configuration

The serial port configuration menu has Basic and Operation modes.

4.5.1 Basic

The Basic menu allows for the configuration of the serial interface type, baud rate, parity, data / stop bits, and flow control for port configuration.

To access this page, click **Port Configuration > Basic**.

Port 1 configuration	
Basic	Operation
Type	RS422 ▾
Baud Rate	9600 ▾
Parity	None ▾
Data Bits	8 ▾
Stop Bits	1 ▾
Flow Control	None ▾
Save	

Figure 4.4 Port Configuration > Basic

The following table describes the items in the previous figure.

Item	Description
Type	Click the drop-down menu to select a serial interface: RS-422 or RS-485.
Baud Rate	Enter a value to specify the baud rate. The value should conform to the current transmission speeds of connected devices when setting the baud rate.
Parity	Click the drop-down menu to select the parity: None, Odd, Even, Mark or Space.
Data Bits	Click the drop-down menu to select the data bits: 5, 6, 7, or 8.
Stop Bits	Click the drop-down menu to select the stop bits: 1, 1.5 or 2.
Flow Control	Click the drop-down menu to select the flow control mode: None, XOn/XOff, RTS/CTS or DTR/DSR
Save	Click Save to save the values and update the screen.

4.5.2 Operation

The Operation menu allows for the configuration of the mode type and related attributes for port configuration.

To access this page, click **Port Configuration > Operation**. Use this menu to select the port configuration mode: Modbus Slave Mode or Modbus Master Mode.

To translate RTU/ASCII to TCP, use Master Mode.

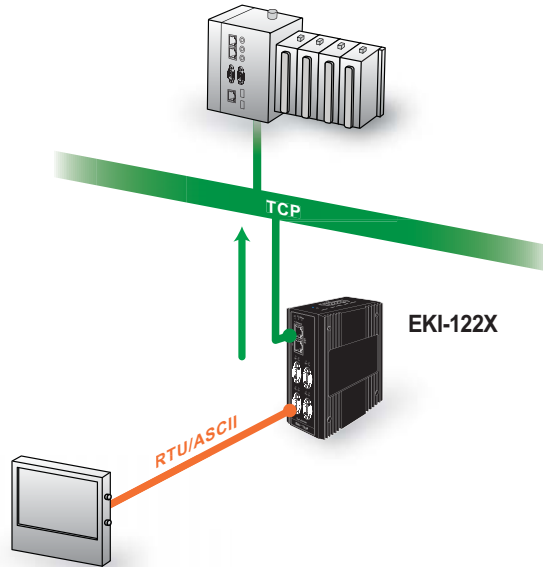

Figure 4.5 Master Mode

To translate TCP to RTU/ASCII, use Slave Mode.

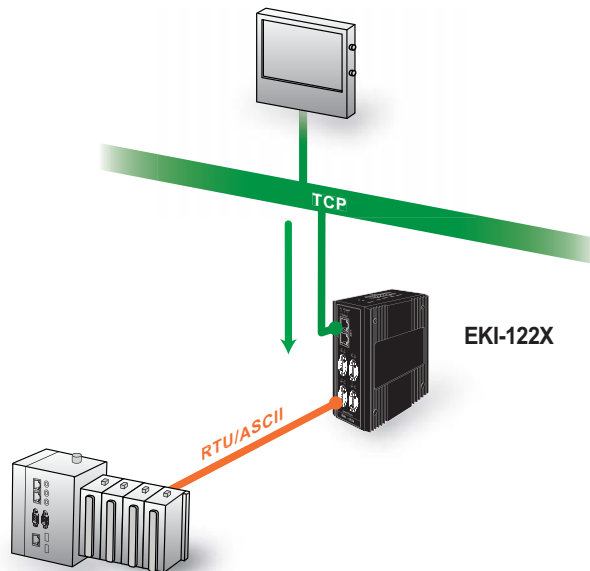

Figure 4.6 Slave Mode

These are the options for Modbus Slave Mode.

Port 1 configuration	
Basic	Operation
Mode	Modbus Slave Mode ▾
Protocol	RTU ▾
Slave Timeout(ms)	3000
Delay Time(ms)	0
ASCII Timeout(ms)	10
Peer for Receiving Data	
Peer Number	0 ▾
Save	

Figure 4.7 Port Configuration > Operation

The following table describes the items in the previous figure.

Item	Description
Mode	Click the drop-down menu to select the port configuration mode: Modbus Slave Mode or Modbus Master Mode.
Protocol	Select the protocol of the Slave Mode or Master Mode (RTU or ASCII).
SlaveTimeout (ms)	Specify the time duration in milliseconds for the EKI-122X series to wait for a response after it has issued a command while using Modbus/RTU or Modbus ASCII. After the timeout is expired and no response is received, the EKI-122X series will regard the command as failed. Note that the timeout for the host PC must be greater than the timeout setting here specified, otherwise an error will occur.
Frame Break (ms)	Enter a value to specify the frame break time.
Peer Number	Click the drop-down menu to select the number of network device which you want to connect.
Save	Click Save to save the values and update the screen.

These are the options for Modbus Master Mode.

Port 1 configuration	
Basic	Operation
Mode	Modbus Master Mode ▾
Protocol	RTU ▾
Master Timeout(ms)	5000
Frame Break(ms)	1000
Peer for Receiving Data	
Peer Number	0 ▾
Save	

Figure 4.8 Port Configuration > Operation

The following table describes the items in the previous figure.

Item	Description
Mode	Click the drop-down menu to select the port configuration mode: Modbus Slave Mode or Modbus Master Mode.
Protocol	Select the protocol of the Slave Mode or Master Mode (RTU or ASCII).

Item	Description
Master Timeout (ms)	Specify the time duration in milliseconds for the EKI-122X series to wait for a response after it has issued a command while using Modbus/RTU or Modbus ASCII. After the timeout is expired and no response is received, the EKI-122X series will regard the command as failed. Note that the timeout for the host PC must be greater than the timeout setting here specified, otherwise an error will occur.
Frame Break (ms)	Enter a value to specify the frame break time.
Peer Number	Click the drop-down menu to select the number of network device which you want to connect.
Save	Click Save to save the values and update the screen.

4.6 Monitor

The EKI serial device server allows monitoring of the serial ports' status. The serial port's operation mode and status is available for display. The IP address of the host PC which is communicating with serial port is also displayed.

The Monitor function provides a method to monitor the serial device server's status (operation mode, baud rate, data bits, stop bits, parity and RTS/XON/DTR).

Monitoring information is divided into three main message types: Setting/Statistic/Connected IP.

4.6.1 Setting

The Monitor Setting page allows for easy viewing of the port's statistics.

To access this page, click **Monitor > Setting**.

Port 1 Status	
Setting	Statistic
Operating Mode	Modbus Slave Mode
Baud rate	9600
Data bits	8
Stop bits	1
Parity	None
RTS/CTS	OFF
XON/XOFF	OFF
DTR/DSR	OFF

Figure 4.9 Monitor > Setting

The following table describes the items in the previous figure.

Item	Description
Operating Mode	Display the current operation mode of the selected port.
Baud Rate	Display the current baud rate of the selected port.
Data Bits	Display the current data bits of the selected port.
Stop Bits	Display the current stop bits of the selected port.
Parity	Display the current parity of the selected port.
RTS/CTS	Display the current RTS/CTS status of the selected port.
XON/XOFF	Display the current XON/OFF status of the selected port.
DTR/DSR	Display the current DTR/DSR status of the selected port.

4.6.2 Statistic

The Monitor Statistic page allows for easy viewing of the port's TX/RX data count. To access this page, click **Monitor > Statistic**.

Port 1 Status		
Setting	Statistic	ConnectedIP
Tx Count	0	
Rx Count	0	
Total Tx Count	0	
Total Rx Count	0	
RTS	ON	
CTS	ON	
DTR	ON	
DSR	ON	
DCD	ON	

Figure 4.10 Monitor > Statistic

The following table describes the items in the previous figure.

Item	Description
Tx Count	Display the current Tx count of the selected port.
Rx Count	Display the current Rx count of the selected port.
Total Tx Count	Display the current total Tx count of the selected port.
Total Rx Count	Display the current total Rx count of the selected port.
RTS	Display the current RTS status of the selected port.
CTS	Display the current CTS status of the selected port.
DTR	Display the current DTR status of the selected port.
DSR	Display the current DSR status of the selected port.
DCD	Display the current DCD status of the selected port.

4.6.3 Connected IP

The Monitor Connected IP page allows for easy viewing of all connected device's IP address.

To access this page, click **Monitor > Connected IP**.

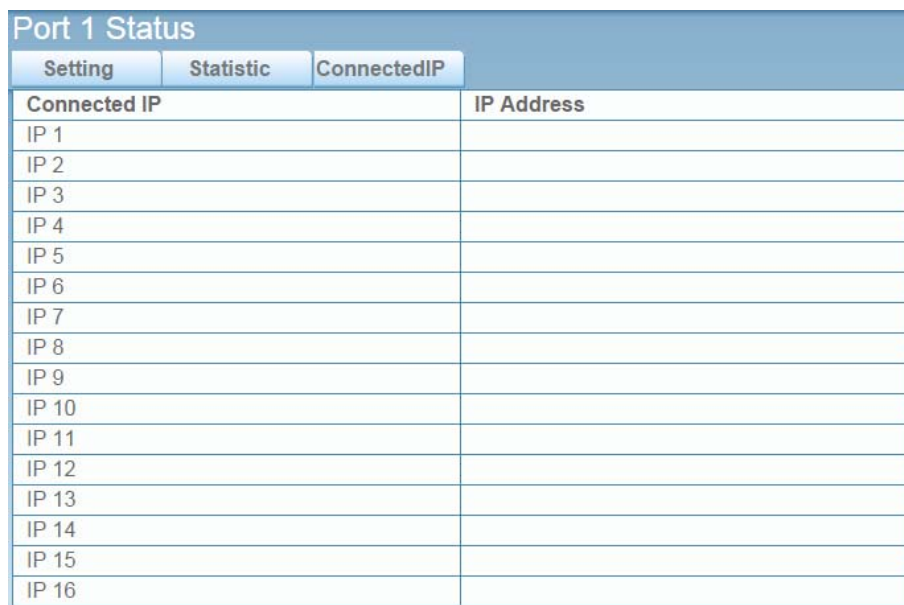

Port 1 Status		
Setting	Statistic	ConnectedIP
Connected IP		IP Address
IP 1		
IP 2		
IP 3		
IP 4		
IP 5		
IP 6		
IP 7		
IP 8		
IP 9		
IP 10		
IP 11		
IP 12		
IP 13		
IP 14		
IP 15		
IP 16		

Figure 4.11 Monitor > Connected IP

The following table describes the items in the previous figure.

Item	Description
Connected IP	Displays the IP designation for the device.
IP Address	Displays the current connected IP address of the selected port.

4.7 Auto Warning (Alarm)

You can set the e-mail server and SNMP Trap server in the Setting page, and set the event type in the Event page.

4.7.1 Setting

The Alarm Setting menu includes three alarm setting menus for event notification: Mail Sever, SNMP Trap Server, and the SNMP Agent Setting.

At the top of the list is the Mail Server setting which allows you to specify the mail server to be used by the serial device server in order to deliver notifications to selected Email accounts.

The SNMP Trap Server settings allows you to specify the management station of a significant event by way of an unsolicited SNMP message.

The Simple Network Management Protocol (SNMP) is used by the serial device server to collect detailed information about the serial device server.

To access this page, click **Alarm > Setting**.

Alarm Setting	
Mail Server	
Mail Server	<input type="text"/>
From Email address	admin@advantech.com
Email address 1	<input type="text"/>
Email address 2	<input type="text"/>
Email address 3	<input type="text"/>
Email address 4	<input type="text"/>
SNMP Trap Server	
Trap Server	<input type="text"/>
Trap Server Port	162
Trap Version	<input checked="" type="radio"/> v1 <input type="radio"/> v2c
Trap Community	public
SNMP Agent Setting	
Read Community	<input type="text"/>
Write Community	<input type="text"/>
Contact	<input type="text"/>
Location	<input type="text"/>
Save	

Figure 4.12 Alarm > Setting

The following table describes the items in the previous figure.

Item	Description
Mail Server	Enter the SMTP mail server.
From Email address	Enter the email address.
Email address 1	Enter the email address 1 to receive alarm emails.
Email address 2	Enter the email address 2 to receive alarm emails.
Email address 3	Enter the email address 3 to receive alarm emails.
Email address 4	Enter the email address 4 to receive alarm emails.
Trap Server	Enter the SNMP Trap server address.
Trap Server Port	Enter the SNMP Trap server port.
Trap Version	Click the radio button to select the SNMP version credentials: v1 or v2c.
Trap Community	Enter the community string to be passed for the specified event.
Read Community	Enter the read-only, public, community string.
Write Community	Enter the write-only, private, community string.
Contact	Enter the individual designated the contact point for this event.
Location	Enter the designated location/department of the setting.
Save	Click Save to save the values and update the screen.

4.7.2 Event

The Alarm Event page allows the selection of triggers for system, DCD and DSR events for the alarm function.

To access this page, click **Alarm > Event**.

Event Type			
System Event			
Cold Start	<input type="checkbox"/> Mail	<input type="checkbox"/> Trap	<input type="checkbox"/> Log
Warm Start	<input type="checkbox"/> Mail	<input type="checkbox"/> Trap	<input type="checkbox"/> Log
Authentication failure	<input type="checkbox"/> Mail	<input type="checkbox"/> Trap	<input type="checkbox"/> Log
IP address changed	<input type="checkbox"/> Mail		
Password changed	<input type="checkbox"/> Mail		
Ethernet1 link down	<input type="checkbox"/> Mail	<input type="checkbox"/> Trap	<input type="checkbox"/> Log
Ethernet2 link down	<input type="checkbox"/> Mail	<input type="checkbox"/> Trap	<input type="checkbox"/> Log
DCD changed			
Port 1	<input type="checkbox"/> Mail	<input type="checkbox"/> Trap	<input type="checkbox"/> Log
Port 2	<input type="checkbox"/> Mail	<input type="checkbox"/> Trap	<input type="checkbox"/> Log
Port 3	<input type="checkbox"/> Mail	<input type="checkbox"/> Trap	<input type="checkbox"/> Log
Port 4	<input type="checkbox"/> Mail	<input type="checkbox"/> Trap	<input type="checkbox"/> Log
DSR changed			
Port 1	<input type="checkbox"/> Mail	<input type="checkbox"/> Trap	<input type="checkbox"/> Log
Port 2	<input type="checkbox"/> Mail	<input type="checkbox"/> Trap	<input type="checkbox"/> Log
Port 3	<input type="checkbox"/> Mail	<input type="checkbox"/> Trap	<input type="checkbox"/> Log
Port 4	<input type="checkbox"/> Mail	<input type="checkbox"/> Trap	<input type="checkbox"/> Log
Save			

Figure 4.13 Alarm > Event

The following table describes the items in the previous figure.

Item	Description
Cold Start	Click the option to select a warning type when the device server's power is cut off and reconnected.
Warm Start	Click the option to select a warning type when the device server is reboot.
Authentication failure	Click the option to select a warning type when an incorrect password is entered.
IP address changed	Click the option to select a warning type when the IP address is changed.
Password changed	Click the option to select a warning type when the password is changed.
Ethernet1 link down	Click the option to select a warning type when the Ethernet 1 port is disconnected.
Ethernet2 link down	Click the option to select a warning type when the Ethernet 2 port is disconnected.
Port	Click the option to select a warning type of the selected port when a change in the DCD (Data Carrier Detect) signal indicates that the modem connection status has changed.
Port	Click the option to select a warning type of the selected port when a change in the DSR (Data Set Ready) signal indicates that the data communication equipment is powered off.
Save	Click Save to save the values and update the screen.

4.8 Syslogd

The EKI serial device server provides the functionality to allow network devices to send event messages to a logging server, also known as a Syslog server, by way of the Syslogd function. The Syslog protocol is supported by a wide range of devices and can be used to log different types of events.

4.8.1 Syslogd Setting

Users can enable the syslogd function to record historical events or messages locally or on a remote syslog server.

To access this page, click **Syslogd > Syslogd Setting**.

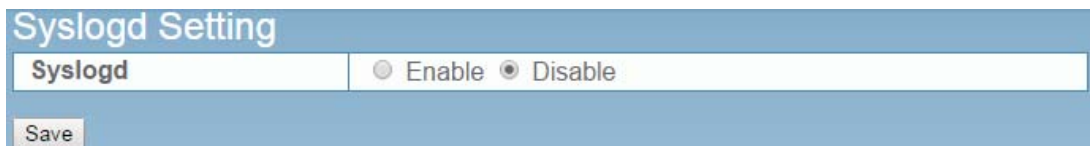

Figure 4.14 Syslogd > Syslogd Setting

The following table describes the items in the previous figure.

Item	Description
Syslogd	Click Enabled or Disabled to set the logging service status.
Save	Click Save to save the values and update the screen.

4.8.2 Syslogd Message

After enabling the syslogd function, users can check the history in the syslogd message page.

To access this page, click **Syslogd > Syslogd Message**.

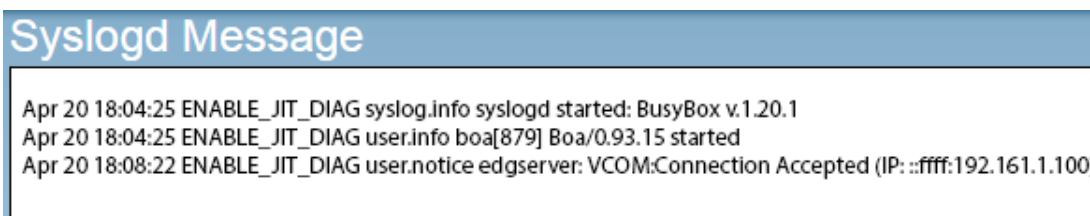

Figure 4.15 Syslogd > Syslogd Message

4.8.3 Modbus IP Mapping

After enabling the syslogd function, users can check the modbus IP mapping.

To access this page, click **Syslogd > Modbus IP Mapping**.

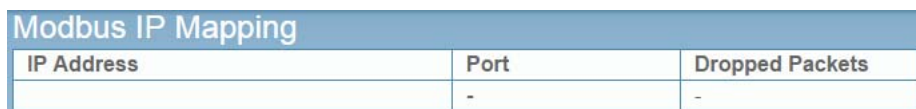

Figure 4.16 Syslogd > Modbus IP Mapping

4.8.4 Modbus Port Mapping

After enabling the syslogd function, users can check the modbus port mapping. To access this page, click **Syslogd > Modbus Port Mapping**.



ID	Port Number	Mapped ID	CRC Error	Timeout
----	-------------	-----------	-----------	---------

Figure 4.17 Syslogd > Modbus Port Mapping

4.9 Tools

The EKI modbus gateway provides tools for access to ping and reset functions.

4.9.1 Ping

The Ping page can help users diagnose ethernet problems. Users can use the ping page to ask the device to ping a specific target to check the Ethernet network status. The Ping page allows you to configure the test log page.

To access this page, click **Tools > Ping**.

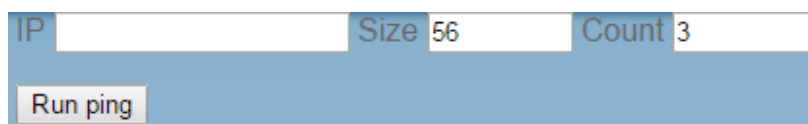

IP Size 56 Count 3

Run ping

Figure 4.18 Tools > Ping

The following table describes the items in the previous figure.

Item	Description
IP	Enter the IP address or host name of the station to ping. The initial value is blank. The IP Address or host name you enter is not retained across a power cycle. Host names are composed of series of labels concatenated with periods. Each label must be between 1 and 63 characters long, maximum of 64 characters.
Size	Enter the size of ping packet. The default value is 56. The value ranges from 8 to 5120. The size entered is not retained across a power cycle.
Count	Enter the number of echo requests to send. The default value is 4. The value ranges from 1 to 5. The count entered is not retained across a power cycle.
Run ping	Display the ping reply format.
Save	Click Save to save the values and update the screen.

4.9.2 Reboot

The configuration will take effect after clicking Save button. But all configurations are saved to flash memory after a system reboot. Press the Reboot button and the system will give a reset response. It will take a few seconds to reconnect with the new values.

To access this page, click **Tools > Reboot**.



Figure 4.19 Tools > Reboot

Click **Reboot** to reboot the serial device server. Any configuration changes you have made since the last time you issued a save will be lost.

4.10 Management

The EKI serial device server allows for easy installation and maintenance and reliable maintenance access from anywhere. With the reliable management tools available, you can streamline staffing and troubleshooting requirements to a centralized system.

4.10.1 Log File

If users enable the system event or serial event to log in file, users can download the log file from here.

To access this page, click **Management > Log File**.

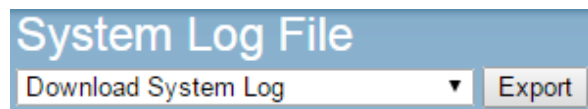

Figure 4.20 Management > Log File

The following table describes the items in the previous figure.

Item	Description
System Log File	Click the drop-down menu to select a specific action for the system log file. Available options: Download System Log, Remove System Log, Download and Remove System Log.
Save	Click Save to save the values and update the screen.

4.10.2 Change Password

The Change Password function allows you to easily update your current password from a single menu.

To access this page, click **Management > Change Password**.



The screenshot shows a web form titled "Change Password". It contains three input fields: "New password", "New password again", and a "Save" button.

Figure 4.21 Management > Change Password

The following table describes the items in the previous figure.

Item	Description
Old password	Enter the old password.
New password	Enter the character set for the define password type.
New password again	Retype the password entry to confirm the profile password.
Save	Click Save to save the values and update the screen.

If you have set a password through the configuration utility or Telnet or serial console, when you access the web configuration, you need to key in the password. It is not necessary to enter the user name in the dialog.

If you want to disable the password protection, change the password to the default option **None** (leave the new password column blank). Be sure to press the **Save** button and reboot the serial device server to make the change effective.

4.10.3 Export Device Settings

Export the server configuration settings to a .conf file.

To access this page, click **Management > Export**.



The screenshot shows a web form titled "Export Configuration File". It contains one button: "Export".

Figure 4.22 Management > Export

Click **Export** to export the serial device server settings.

4.10.4 Import Device Settings

Import the server configuration settings to a .conf file.

To access this page, click **Management > Import**.

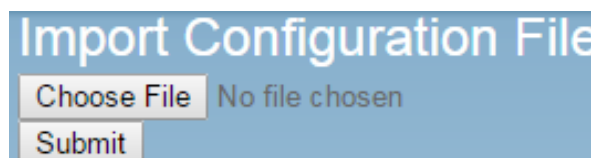

The screenshot shows a web form titled "Import Configuration File". It contains two buttons: "Choose File" and "Submit". The text "No file chosen" is displayed next to the "Choose File" button.

Figure 4.23 Management > Import

The following table describes the items in the previous figure.

Item	Description
Choose File	Click Choose File to select the configuration file.
Submit	Click Submit to backup the settings.

ADVANTECH

Enabling an Intelligent Planet

www.advantech.com

Please verify specifications before quoting. This guide is intended for reference purposes only.

All product specifications are subject to change without notice.

No part of this publication may be reproduced in any form or by any means, electronic, photocopying, recording or otherwise, without prior written permission of the publisher.

All brand and product names are trademarks or registered trademarks of their respective companies.

© Advantech Co., Ltd. 2016