

REVISIONS				
REV.	ECO. NO	DESCRIPTION	DATE	BY
A	1269	INITIAL RELEASE	2/3/2007	MV
B	1390	ADD PIN WIDTH CALL-OUT; ADD CURRENT RATING TO F MATERIAL	6/18/2007	MNH
C	1662	UPDATE DRAWING FORMAT & PART NUMBER CODING	4/24/2008	VJ

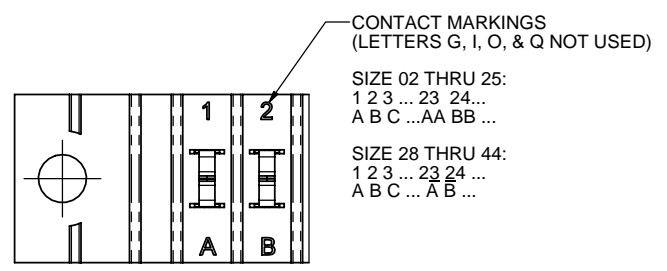
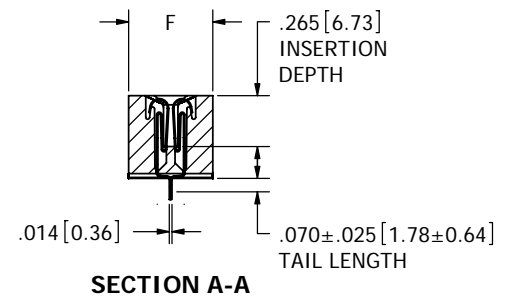
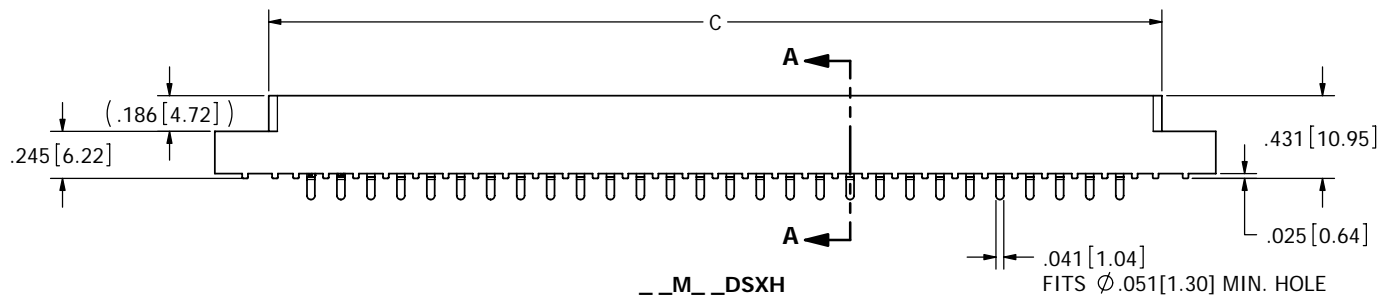
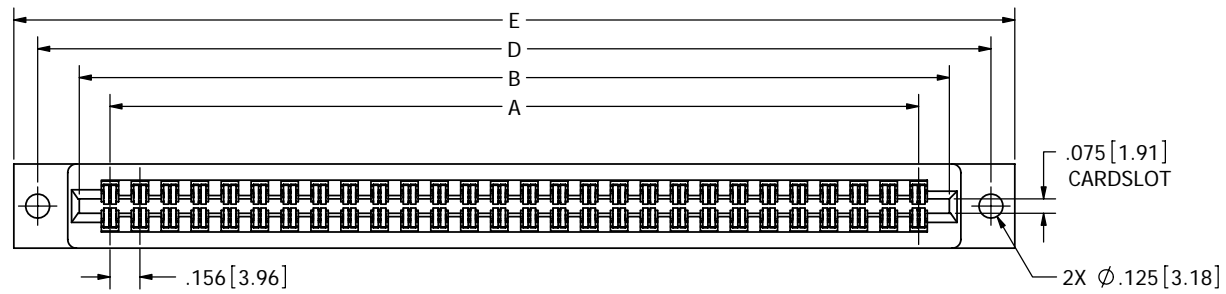

CONTACT ID
SCALE 4 : 1

NOTES:

- INSULATOR MATERIAL: SEE PART NUMBER CODING.
- CONTACT MATERIAL: SEE PART NUMBER CODING.
- PLATING: SEE PART NUMBER CODING.
- TEMPERATURE: SEE PART NUMBER CODING.
- PROCESSING TEMP: SEE PART NUMBER CODING.
- UL FLAMMABILITY RATING: 94V-0.
- VOLTAGE RATING: 1800 VDC MINIMUM AT SEA LEVEL.
- CURRENT RATING: SEE PART NUMBER CODING.
- VOLTAGE DROP: 30 MILLI VOLT AT RATED CURRENT.
- INSULATION RESISTANCE: 5000 MEGA OHMS.
- CONNECTOR IDENTIFICATION: THE PART SHALL BE MARKED WITH A PART NUMBER AND BARCODE.
- BOARD THICKNESS ACCOMMODATED: $.062 \pm .008$ [1.57 ± 0.20].
- BOARD INSERTION FORCE: 16 OZ MAX PER CONTACT PAIR WHEN USING A .062 [1.57] TEST BLADE. INTERNAL INSPECTION TO BE PER SULLIN'S WORK INSTRUCTION W17.3-01.
- BOARD WITHDRAWAL FORCE: 1 OUNCE MINIMUM PER CONTACT PAIR USING .062 [1.57] PCB.

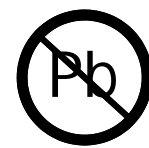

RoHS COMPLIANT

CUSTOMER COPY

UNLESS OTHERWISE SPECIFIED:
DIMENSIONS ARE IN INCHES [MM]
TOLERANCES:
ANGULAR: $\pm 30'$
XX $\pm .02$ [508]
XXX $\pm .005$ [1270]
XXXX $\pm .0005$ [0127]
SURFACE FINISH: 63 Rz
REMOVE ALL BURRS AND SHARP EDGES .010 MAX

INTERPRET DIMENSIONS AND GEOMETRIC TOLERANCING PER: ANSI Y14.5M-1994

DRAWN	2/3/2007	DATE	MV	NAME
THE INFORMATION HEREIN CONTAINS PROPRIETARY INFORMATION OF SULLINS ELECTRONICS AND IS NOT TO BE REPRODUCED, USED OR DISCLOSED TO OTHERS FOR ANY PURPOSE EXCEPT AS SPECIFICALLY AUTHORIZED IN WRITING BY AN OFFICER OF SULLINS ELECTRONICS.				
PART NUMBER M_DSX		DESCRIPTION EDGECARD, .156 CC, LP		
SIZE C	DWG. NO. C10891	REV C	SCALE: 2:1 SHEET 1 OF 3	

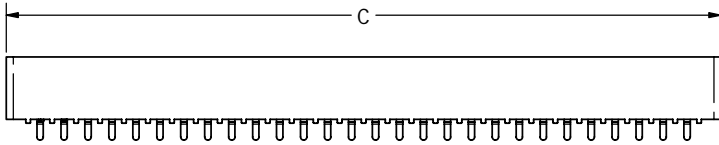
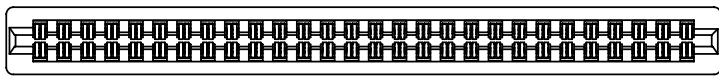

--M--DSXN

2X #4-40
THREADED
INSERT

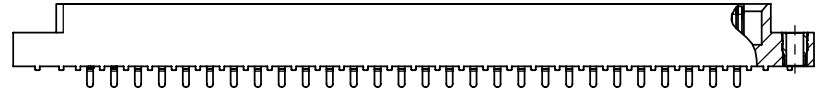
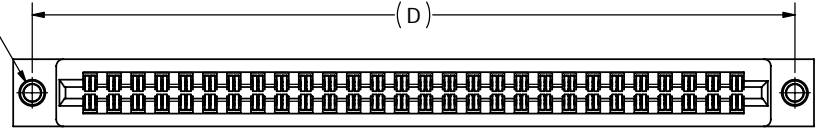

--M--DSXI

2X FLOATING BOBBIN
Ø.116 [2.95] CLEARANCE
FOR # 4 SCREW

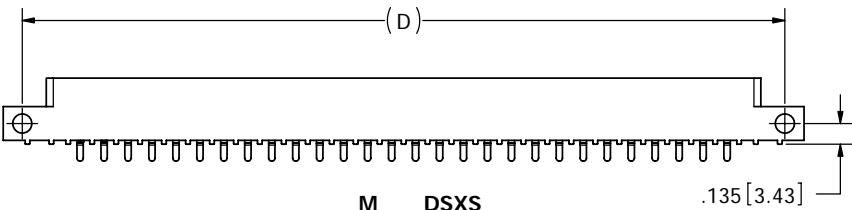
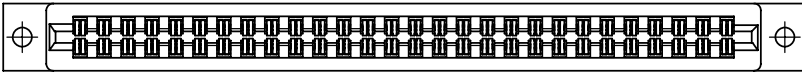

--M--DSXS

.135 [3.43]

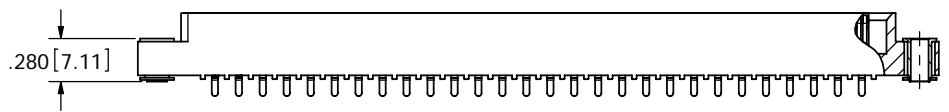
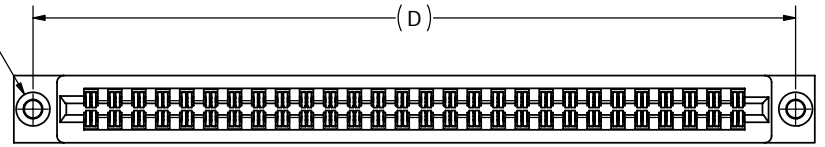

--M--DSXF

.280 [7.11]

CUSTOMER COPY



RoHS COMPLIANT

UNLESS OTHERWISE SPECIFIED:
DIMENSIONS ARE IN INCHES[MM]

TOLERANCES:
ANGULAR: ± 30'
XX ± .02 [508]
XXX ± .005 [1270]
.XXX ± .0005 [0127]
SURFACE FINISH: 63 Rz
REMOVE ALL BURRS AND SHARP EDGES .010 MAX

INTERPRET DIMENSIONS AND GEOMETRIC
TOLERANCING
PER: ANSI Y14.5M-1994

DRAWN	DATE	NAME
MV	2/3/2007	MV

THE INFORMATION HEREIN CONTAINS
PROPRIETARY INFORMATION OF
SULLINS ELECTRONICS AND IS NOT
TO BE REPRODUCED, USED OR
DISCLOSED TO OTHERS FOR ANY
PURPOSE EXCEPT AS SPECIFICALLY
AUTHORIZED IN WRITING BY AN
OFFICER OF SULLINS ELECTRONICS.

DESCRIPTION:
EDGE CARD, .156 CC, LP

PART NUMBER
M_DSX

SIZE	DWG. NO.	REV
C	C10891	C

SCALE: 2:1 SHEET 2 OF 3

PART NUMBER	NO. OF POS.	A $\pm .008[0.20]$		B $\pm .008[0.20]$		C $\pm .015[0.38]$		D $\pm .010[0.25]$		E $\pm .020[0.51]$		E $\pm .020[0.51]$		F $\pm .005[0.13]$			
		IN	MM	IN	MM	IN	MM	IN	MM	IN	MM	IN	MM	IN	MM		
_M02DSXN	2	0.156	3.96	0.476	12.09	0.596	15.14	"N" MOUNTING								0.325	8.26
_M03DSXN	3	0.312	7.92	0.632	16.05	0.752	19.10										
_M06DSX	6	0.780	19.81	1.100	27.94	1.220	30.99	1.533	38.94	1.782	45.26	1.882	47.80				
_M08DSX	8	1.092	27.74	1.412	35.86	1.532	38.91	1.845	46.86	2.094	53.19	2.194	55.73				
_M10DSX	10	1.404	35.66	1.724	43.79	1.844	46.84	2.157	54.79	2.406	61.11	2.506	63.65				
_M11DSX	11	1.560	39.62	1.880	47.75	2.000	50.80	2.313	58.75	2.562	65.07	2.662	67.61				
_M12DSX	12	1.716	43.59	2.036	51.71	2.156	54.76	2.469	62.71	2.718	69.04	2.818	71.58				
_M15DSX	15	2.184	55.47	2.504	63.60	2.624	66.65	2.937	74.60	3.186	80.92	3.286	83.46				
_M18DSX	18	2.652	67.36	2.972	75.49	3.092	78.54	3.405	86.49	3.654	92.81	3.754	95.35				
_M22DSX	22	3.276	83.21	3.596	91.34	3.716	94.39	4.029	102.34	4.278	108.66	4.378	111.20				
_M24DSX	24	3.588	91.14	3.908	99.26	4.028	102.31	4.341	110.26	4.590	116.59	4.690	119.13				
_M25DSX	25	3.744	95.10	4.064	103.23	4.184	106.27	4.497	114.22	4.746	120.55	4.846	123.09				
_M28DSX	28	4.212	106.98	4.532	115.11	4.652	118.16	4.965	126.11	5.214	132.44	5.314	134.98	0.438	11.13		
_M36DSX	36	5.460	138.68	5.780	146.81	5.900	149.86	6.213	157.81	6.462	164.13	6.562	166.67				
_M43DSX	43	6.552	166.42	6.872	174.55	6.992	177.60	7.305	185.55	7.554	191.87	7.654	194.41	0.500	12.70		
_M44DSX	44	6.708	170.38	7.028	178.51	7.148	181.56	7.461	189.51	7.710	195.83	7.810	198.37				

Only applies for
PPS/PEEK
insulators with
threaded inSXrts
or floats

PART NUMBER CODING

-- M -- DSX --

MATERIAL (INSULATOR/CONTACT)

- E = PBT/PHOSPHOR BRONZE**
OPERATING TEMP: -65°C TO +125°C @ 3 AMPS PER CONTACT
OPERATING TEMP: -65°C TO +21°C @ 5 AMPS PER CONTACT
PROCESSING TEMP: 260°C FOR 10 SECS MAX
- R = PPS/PHOSPHOR BRONZE**
OPERATING TEMP: -65°C TO +125°C
PROCESSING TEMP: 260°C FOR 120 SECS MAX
CURRENT RATING PER CONTACT: 5 AMPS
- G = PA9T/PHOSPHOR BRONZE**
OPERATING TEMP: -65°C TO +125°C
PROCESSING TEMP: 260°C FOR 120 SECS MAX
CURRENT RATING PER CONTACT: 5 AMPS
- H = PBT/BERYLLIUM COPPER**
OPERATING TEMP: -65°C TO +125°C @ 3 AMPS PER CONTACT
OPERATING TEMP: -65°C TO +105°C @ 5 AMPS PER CONTACT
PROCESSING TEMP: 260°C FOR 10 SECS MAX
- A = PPS/BERYLLIUM COPPER**
OPERATING TEMP: -65°C TO +150°C
PROCESSING TEMP: 260°C FOR 120 SECS MAX
CURRENT RATING PER CONTACT: 5 AMPS
- J = PA9T/BERYLLIUM COPPER**
OPERATING TEMP: -65°C TO +150°C
PROCESSING TEMP: 260°C FOR 120 SECS MAX
CURRENT RATING PER CONTACT: 5 AMPS
- F = PPS/SPINODAL (CONSULT FACTORY)**
AVAILABLE IN OVERALL GOLD ONLY (S OR M PLATING CODE)
OPERATING TEMP: -65°C TO +200°C
PROCESSING TEMP: 260°C FOR 120 SECS MAX
CURRENT RATING PER CONTACT: 3 AMPS
- C = PPS/BERYLLIUM COPPER (CONSULT FACTORY)**
AVAILABLE IN OVERALL GOLD ONLY (S OR M PLATING CODE)
OPERATING TEMP: -65°C TO +200°C @ 2 AMPS PER CONTACT
OPERATING TEMP: -65°C TO +173°C @ 3 AMPS PER CONTACT
PROCESSING TEMP: 260°C FOR 120 SECS MAX
- W = PEEK/BERYLLIUM COPPER (CONSULT FACTORY)**
AVAILABLE IN OVERALL GOLD ONLY (S OR M PLATING CODE)
OPERATING TEMP: -65°C TO +250°C
CURRENT RATING PER CONTACT: 3 AMPS
(CONSULT FACTORY FOR OTHER MATERIALS)

MOUNTING STYLE

- H = .125" DIA. CLEARANCE HOLES (PAGE 1)
- N = NO MOUNTING EARS (PAGE 2)
- S = .125" DIA. SIDE MOUNTING (PAGE 2)
- I = #4-40 THREADED INSERT (PAGE 2)
- F = FLOATING BOBBIN (PAGE 2)

NUMBER OF POSITIONS (CONTACTS PER ROW)

PLATING

- ALL PLATINGS ARE LEAD FREE AND HAVE .000050" NICKEL UNDERPLATE
- | CONTACT SURFACE | TERMINATION |
|--|--------------------------|
| G = .000010" GOLD | .000005" GOLD |
| Y = .000030" GOLD | .000005" GOLD |
| B = .000010" GOLD | .000100" PURE TIN, MATTE |
| C = .000030" GOLD | .000100" PURE TIN, MATTE |
| **E = .000100" PURE TIN, MATTE, OVERALL | |
| S = .000010" GOLD OVERALL | .000010" GOLD OVERALL |
| M = .000030" GOLD | |
| ** OVERALL TIN ONLY AVAILABLE ON MATERIAL CODES E, R AND G | |

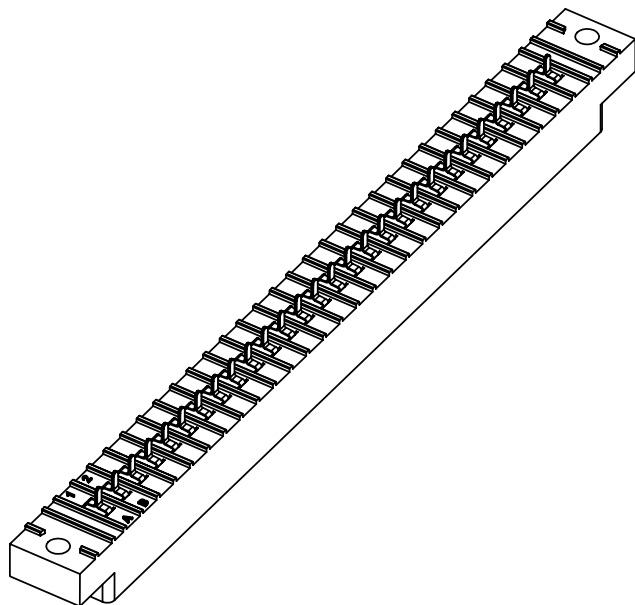

CUSTOMER COPY



RoHS COMPLIANT

UNLESS OTHERWISE SPECIFIED:
DIMENSIONS ARE IN INCHES[MM]
TOLERANCES:
ANGULAR: ± 30'
XX ± .02 [508]
XXX ± .005 [1270]
XXXX ± .0005 [0127]
SURFACE FINISH: 63 Ra
REMOVE ALL BURRS AND SHARP EDGES .010 MAX

INTERPRET DIMENSIONS AND GEOMETRIC TOLERANCING PER: ANSI Y14.5M-1994

DATE	2/3/2007	NAME	MV
THE INFORMATION HEREIN CONTAINS PROPRIETARY INFORMATION OF SULLINS ELECTRONICS AND IS NOT TO BE REPRODUCED, USED OR DISCLOSED TO OTHERS FOR ANY PURPOSE EXCEPT AS SPECIFICALLY AUTHORIZED IN WRITING BY AN OFFICER OF SULLINS ELECTRONICS.			
DESCRIPTION: EDGECARD, .156 CC, LP			
PART NUMBER: M_DSX			
SIZE	C	DWG. NO.	C10891
REV	C		
SCALE:	1:1		
	SHEET 3 OF 3		