

Spring Loaded Contacts

Contents

ATE Spring Probes

Introduction

One Part Probes

Two Part Probes

Spring Loaded Contacts

Specifications

SMT with PC Tail

SMT, no PC Tail

SMT Contact Pads

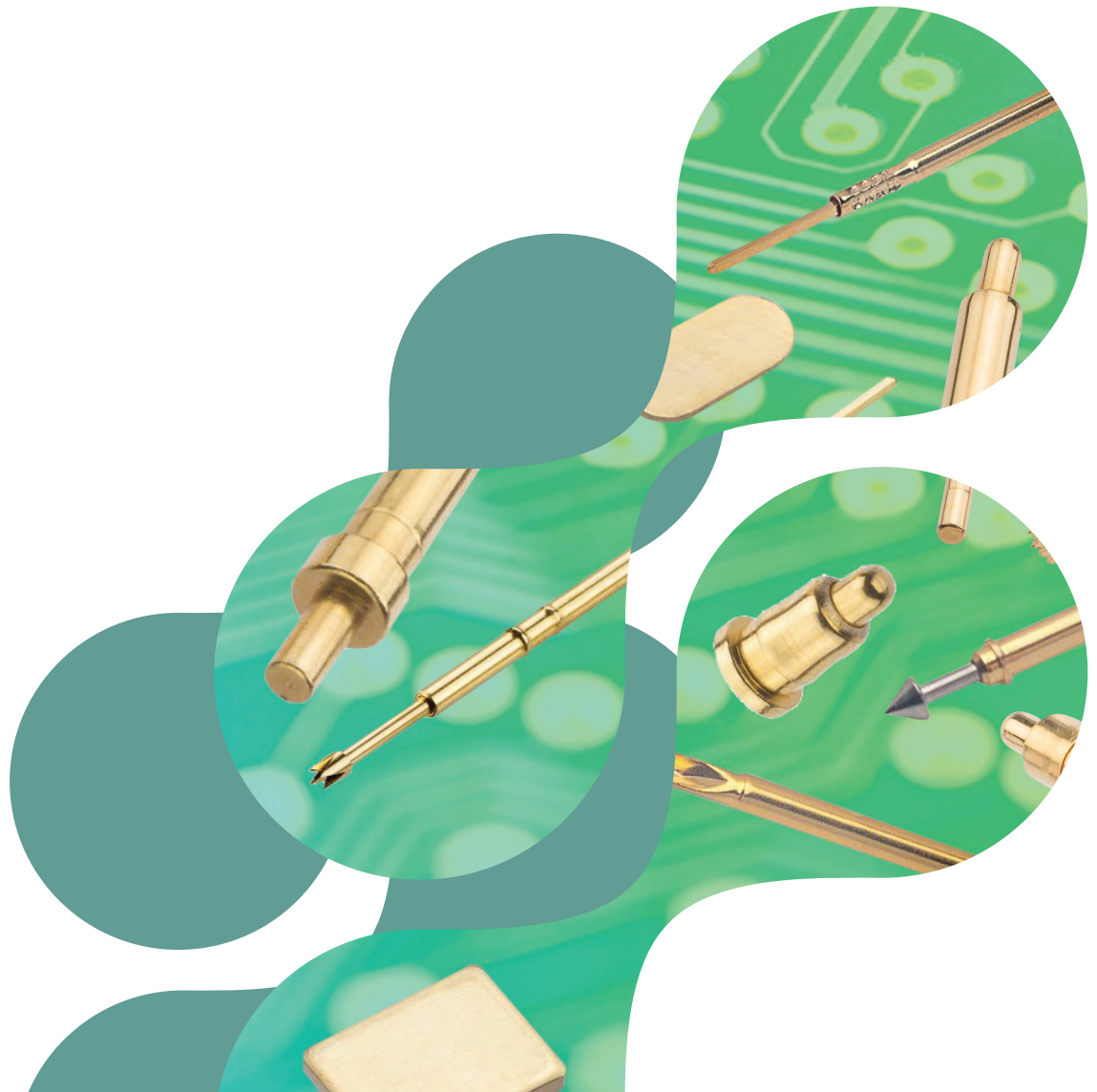

ATE Spring Probes Specification

Materials

Plunger	
P1113CA3, P1113CV3:	Brass, Gold Finish
P1113SS3:	High Carbon Steel, Nickel finish
P13-0123, P19-0121, P25-0126:	Steel, Gold finish
Other Two-Part Spring Probes:	Beryllium Copper, Gold finish
Barrel	
P25-0126:	Phosphor Bronze, Gold finish
Other Probes:	Brass, Gold finish
Spring	
P1113xx3, P25-0126:	Spring Steel, Gold finish
P13-0123:	Music Wire, Gold finish
Other Two-Part Spring Probes:	Stainless Steel
Sleeve	
S13-503:	Phosphor Bronze, Gold finish
Others:	Brass, Gold finish

Packaging

Format:	Loose
---------	-------

Electrical

Current	
P1113xx3:	2A max
P13-xx23:	1.5A
Other Two-Part Spring Probes:	3A
Contact resistance	
P1113xx3:	50mΩ max
P13-xx23, P19-xx21:	100mΩ max at 2/3 travel
P25-4021:	100mΩ max at 2/3 travel
P25-0822, P25-xx23:	50mΩ max at 2/3 travel
P25-xx26:	30mΩ max



Mechanical

Durability:	100,000 operations min
Full travel:	See individual pages
Spring force at full travel:	See individual pages

Environmental

Operating temperature:	-40°C to +180°C
-------------------------------	-----------------

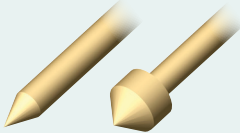
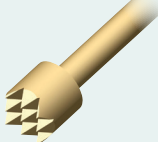
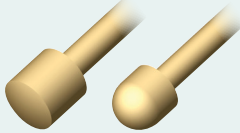
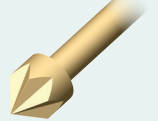
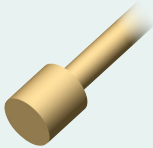
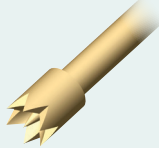
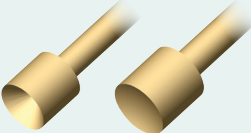
Plunger Head Styles

HEAD STYLE		TYPICAL USE	HEAD STYLE		TYPICAL USE
SPEAR, CONVEX		PCB lands and pads, clean plated through holes	SERRATED		Slightly contaminated leads, pin and blades; male connector pins
CONVEX RADIUS, SPHERICAL RADIUS		Edge fingers, some connectors; positive contacts without marking or indentations	STAR		PCB plated through holes, connector testing; self-cleaning
FLAT		Clean male pins, lands and pads	TULIP		General purpose; 6 outer points, one central; self-cleaning
CONCAVE, CONCAVE RADIUS		Clean leads or clean terminal pins	CROWN		Contaminated PCB leads and pads; self-cleaning

All dimensions in mm.

ATE Spring Probes

One-Part Test Probes

- Single piece spring test probe, with a selection of head styles for different probing surfaces.
- Can be assembled as either interference fit to a test jig, and wire attached to the rear groove, or clearance fit and soldered to a PCB for electrical connection.

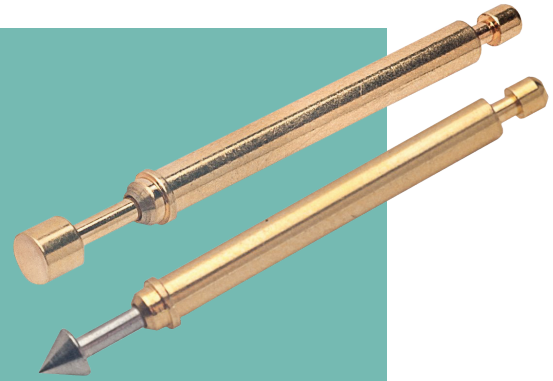

Mechanical

Full travel: 3.18mm

Spring force

At full travel: 0.75N

At working length (2.20mm travel): 0.54N

- Suitable for a minimum pitch spacing of 3mm.

- Recommended PC Board Hole: $\varnothing 2.20\text{mm}$ (clearance fit) or $\varnothing 2.00\text{mm}$ (interference fit).

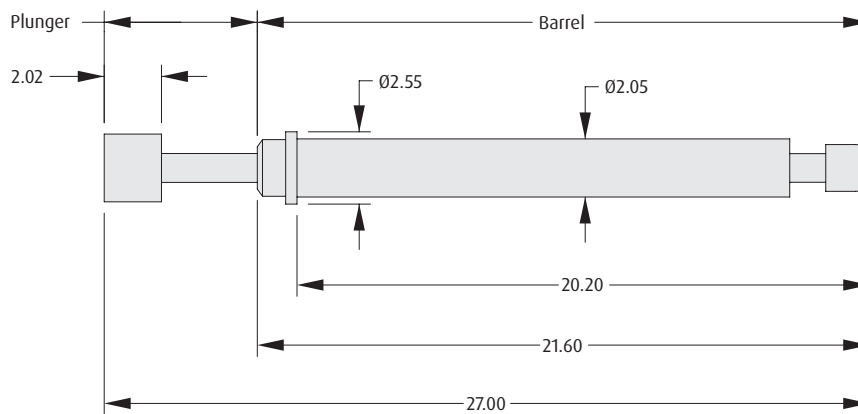

CONCAVE RADIUS HEAD

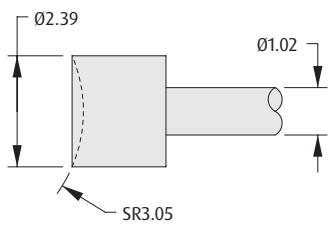

ORDER CODE

P1113CA3

CONVEX RADIUS HEAD

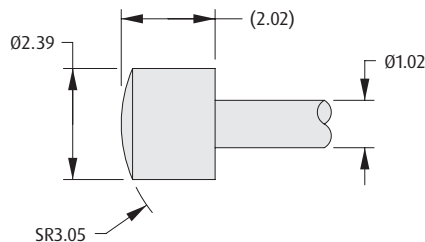

ORDER CODE

P1113CV3

CONVEX HEAD

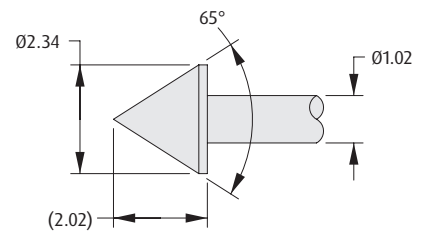

ORDER CODE

P1113SS3

All dimensions in mm.

ATE Spring Probes

Two-Part Test Probes for 1.27mm Pitch

- ❖ Two piece test probe – probe can be replaced when damaged or worn out, without re-soldering to test jig.
- ❖ Sleeve can be assembled as either interference fit to a test jig, and wire attached to the rear bore, or clearance fit and soldered to a PCB for electrical connection.
- ❖ Slim miniature probes, suitable for mounting at 1.27mm pitch between centres.

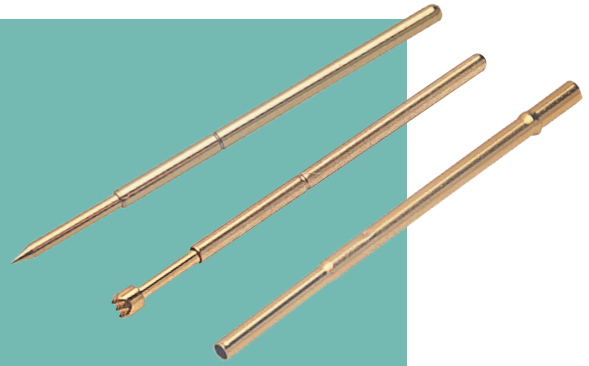

SPRING PROBES

❖ Mechanical

Full travel: 2.65mm
 Spring force
 At full travel: 1.18N
 At 2/3 travel: 0.88N

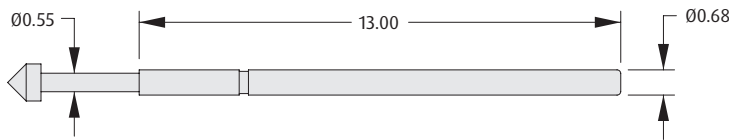

SPEAR HEAD

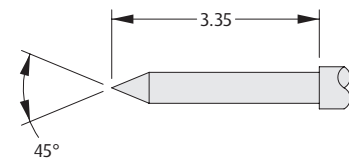

ORDER CODE
P13-0123

CONCAVE HEAD

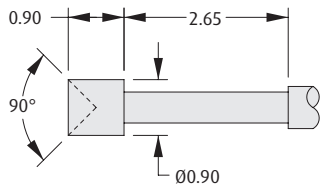

ORDER CODE
P13-1123

CONVEX HEAD

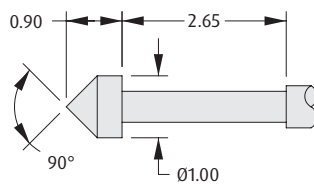

ORDER CODE
P13-2123

SERRATED HEAD

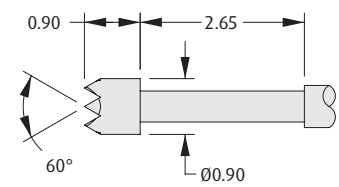

ORDER CODE
P13-4023

SLEEVE

- ❖ Suitable for use with 30AWG wire.

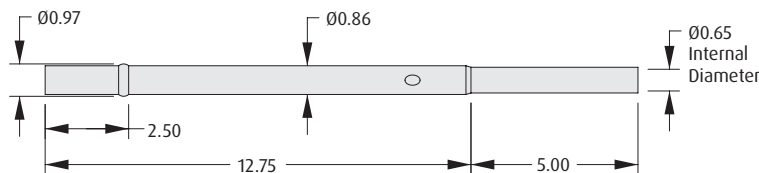

Recommended
PC Board Pattern

ORDER CODE
S13-503

All dimensions in mm.

ATE Spring Probes

Two-Part Test Probes for 1.90mm Pitch

- Two piece test probe – probe can be replaced when damaged or worn out, without re-soldering to test jig.
- Sleeve can be assembled as either interference fit to a test jig, and wire attached to the rear bore, or clearance fit and soldered to a PCB for electrical connection.
- Slim miniature probes, suitable for mounting at 1.90mm pitch between centres.



Mechanical

Full travel: 2.54mm
 Spring force
 At full travel: 1.26N
 At 2/3 travel: 0.88N

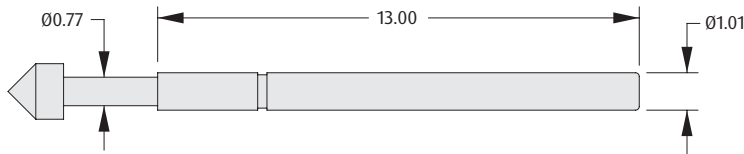

SPEAR HEAD

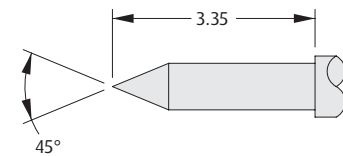

ORDER CODE
P19-0121

CONCAVE HEAD

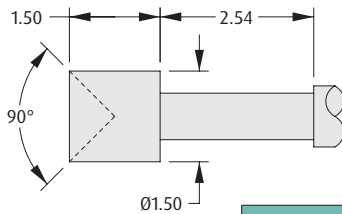

ORDER CODE
P19-1121

CONVEX HEAD

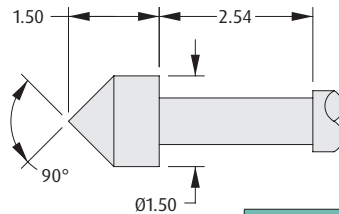

ORDER CODE
P19-2221

SERRATED HEAD

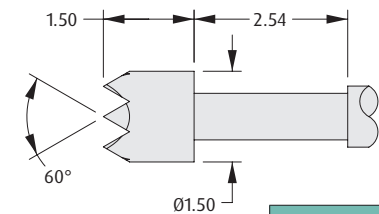

ORDER CODE
P19-4021

SLEEVE

- Suitable for use with 24 to 30AWG wire.

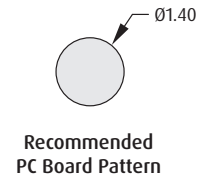
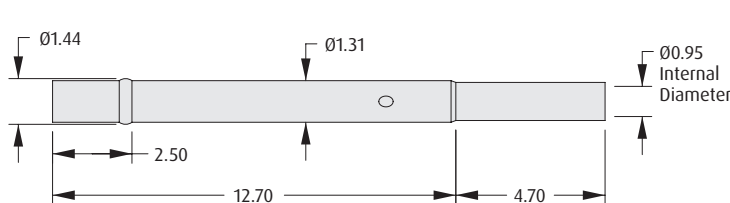

ORDER CODE
S19-501

All dimensions in mm.

ATE Spring Probes

Two-Part Test Probes for 2.54mm Pitch

- ❖ Two piece short probe, for low-profile test jigs.
- ❖ Can be mounted at 2.54mm pitch between centres.
- ❖ Serrated Head style – see Introduction page for applications.

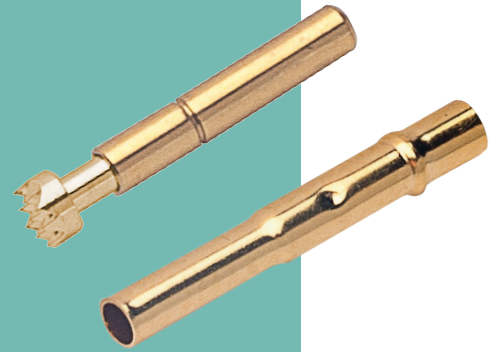

SPRING PROBES

❖ Mechanical

Full travel:	1.50mm
Spring force	
At full travel:	1.08N
At 2/3 travel:	0.78N

7.5mm BODY

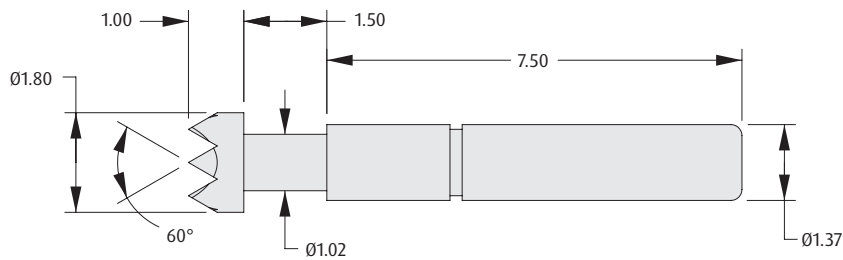

ORDER CODE

P25-4021

SLEEVE

- ❖ Suitable for use with 22 to 30AWG wire.

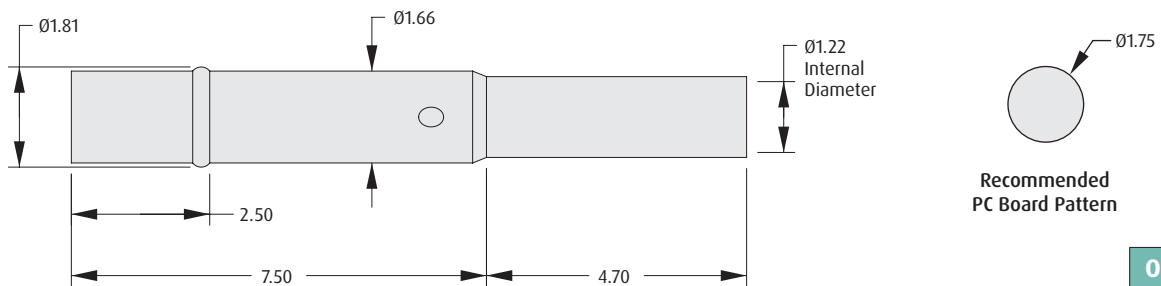

ORDER CODE

S25-501

All dimensions in mm.

ATE Spring Probes

Two-Part Test Probes for 2.54mm Pitch

- Two piece test probe – probe can be replaced when damaged or worn out, without re-soldering to test jig.
- Medium-length probes for 2.54mm minimum pitch, with 4.2mm travel.
- Applicable sleeves shown on following page.

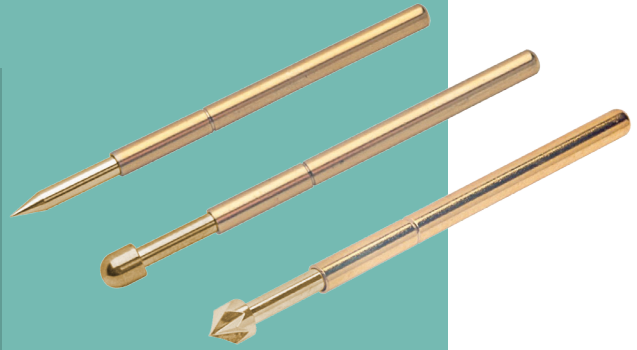

Mechanical

Full travel: 4.20mm

Spring force

At full travel: 1.47N

At 2/3 travel: 1.13N

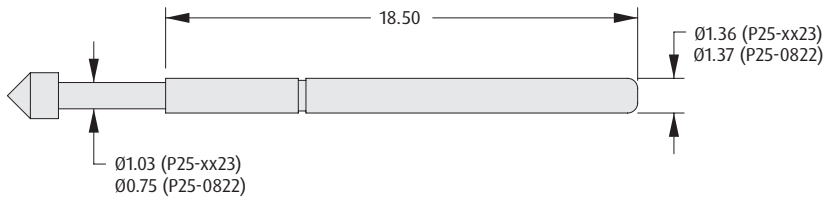

FLAT HEAD

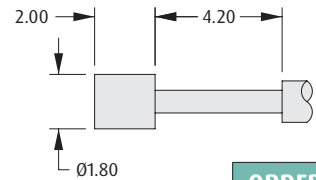

ORDER CODE

P25-0822

SPEAR HEAD

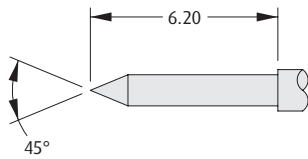

ORDER CODE

P25-0123

SPHERICAL RADIUS HEAD

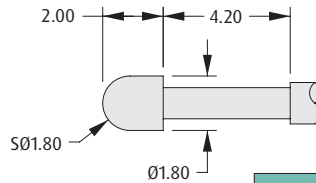

ORDER CODE

P25-0423

CONCAVE HEAD

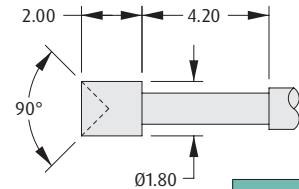

ORDER CODE

P25-1223

CONVEX HEAD

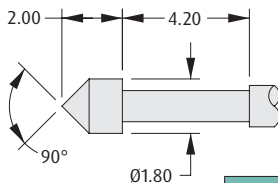

ORDER CODE

P25-2223

SERRATED HEAD

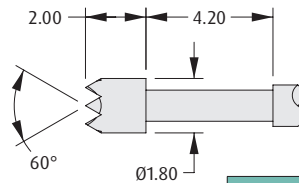

ORDER CODE

P25-4023

STAR HEAD

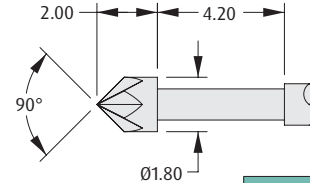

ORDER CODE

P25-5223

All dimensions in mm.

ATE Spring Probes

Two-Part Test Probes for 2.54mm Pitch

- ❖ For use with probes with 18.5mm body length, as shown on previous page.
- ❖ Sleeve can be assembled as either interference fit to a test jig, and wire attached to the rear bore, or clearance fit and soldered to a PCB for electrical connection.

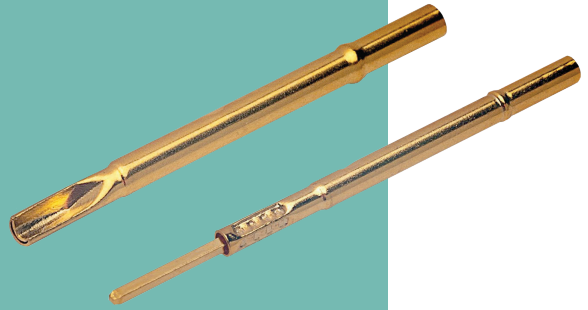

SOLDER CUP SLEEVE

- ❖ Suitable for use with 22 to 30AWG wire.

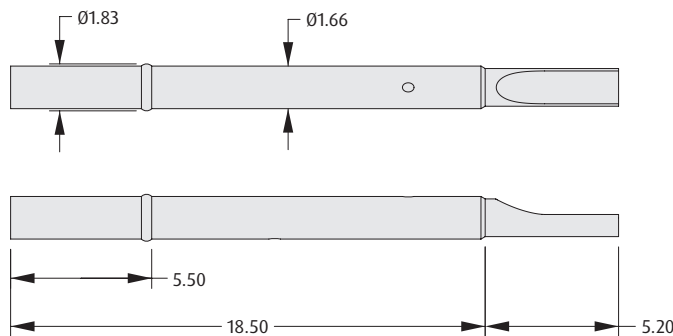

ORDER CODE
S25-022

WIRE-WRAP TAIL SLEEVE

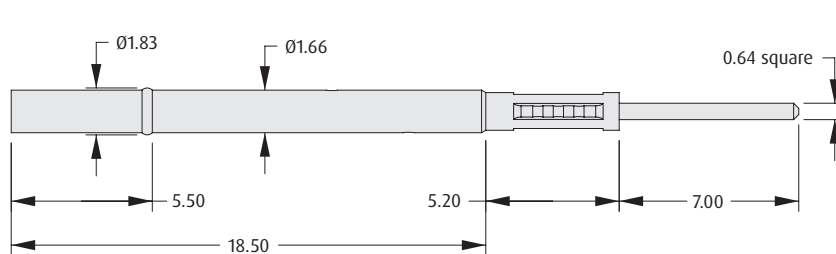

ORDER CODE
S25-212

SOLDER BARREL SLEEVE

- ❖ Suitable for use with 22 to 30AWG wire.

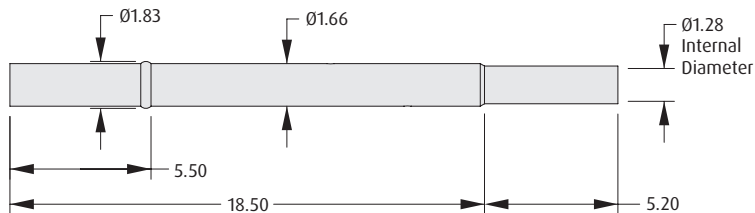

ORDER CODE
S25-512

All dimensions in mm.

ATE Spring Probes

Two-Part Test Probes for 2.54mm Pitch

- Two piece test-probe – probe can be replaced when damaged or worn out, without re-soldering to test jig.
- Sleeve can be assembled as either interference fit to a test jig, and wire attached to the rear bore, or clearance fit and soldered to a PCB for electrical connection.
- Long length probe bodies with 6.3mm travel, for 2.54mm minimum pitch.



Mechanical

Full travel: 6.30mm

Spring force

At full travel: 2.45N

At 2/3 travel: 1.67N

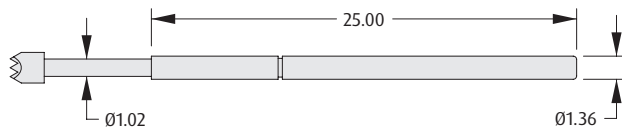

SPEAR HEAD

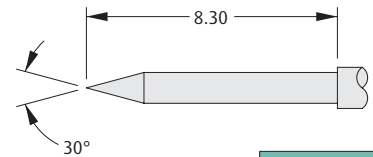

ORDER CODE

P25-0126

TULIP HEAD

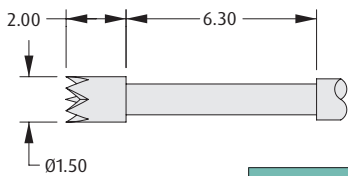

ORDER CODE

P25-1726

CROWN HEAD

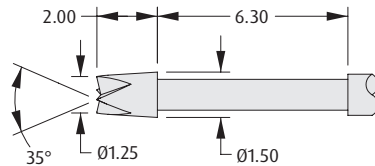

ORDER CODE

P25-3226

SERRATED HEAD

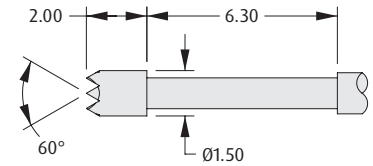

ORDER CODE

P25-4026

WIRE WRAP TAIL SLEEVE

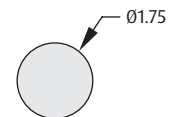
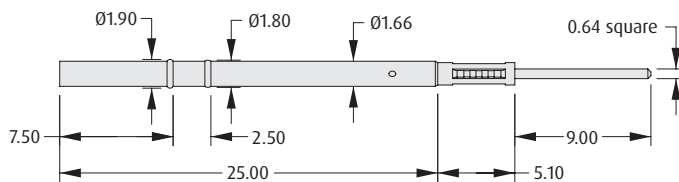

Recommended
PC Board Pattern

ORDER CODE

S25-346

SOLDER BARREL SLEEVE

- Suitable for use with 22 to 30AWG wire.

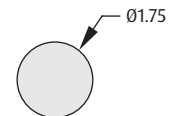
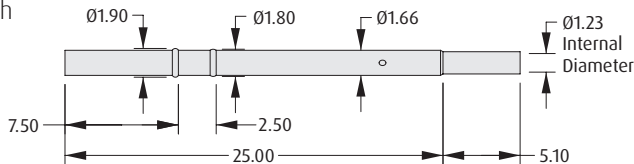

Recommended
PC Board Pattern

ORDER CODE

S25-546

All dimensions in mm.

Spring Loaded Contact Specification

Materials

Plunger:	Brass, Gold finish
Barrel:	Brass, Gold finish
Spring:	Stainless Steel

Packaging

Format:	See individual pages
Connectors:	Tape and Reel
Single contacts:	See individual pages

Electrical

Current:	2A or 1A (see individual pages)
Contact resistance:	50mΩ max

Mechanical

Durability:	10,000 operations
Spring force at working height:	See individual pages

Environmental

Operating temperature:	-40°C to +85°C
Solderability:	235°C for 5 seconds
Soldering heat resistance:	260°C for 10 seconds

Spring Loaded Contacts

Single Spring Loaded Contacts – SMT with Peg

- ❖ These pogo pins are intended to be used as surface mount with a location peg, but they can also be used as a throughboard tail version.
- ❖ Available in Tape and Reeled packaging format for automated assembly methods.
- ❖ Gold finish for improved wear resistance.
- ❖ Additional height options shown on following page.



❖ Packaging

Reel quantity

- P70-6000045R: 1,800 on a Ø330mm reel
- P70-2000045R: 800 on a Ø330mm reel
- P70-2010045R: 700 on a Ø330mm reel

❖ Electrical

Current

- P70-6000045R: 1A
- P70-2000045R: 2A
- P70-2010045R: 2A

❖ Mechanical

Spring force at working height

- P70-6000045R: 0.39N ±0.09N at 2.10mm working height
- P70-2000045R: 1.27N ±0.34N at 2.90mm working height
- P70-2010045R: 1.32N +0.39/-0.29N at 4.00mm working height

2.8mm FREE HEIGHT

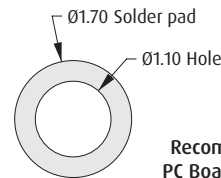
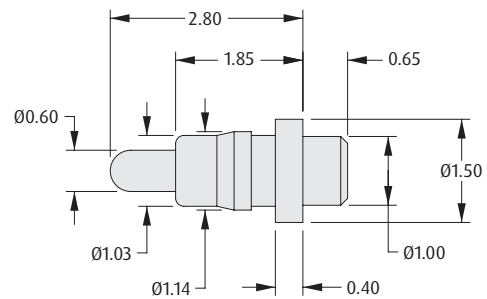

Recommended
PC Board Pattern

ORDER CODE
P70-6000045R

3.6mm FREE HEIGHT

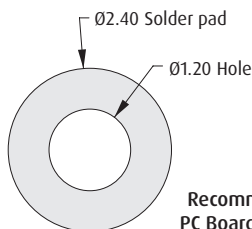
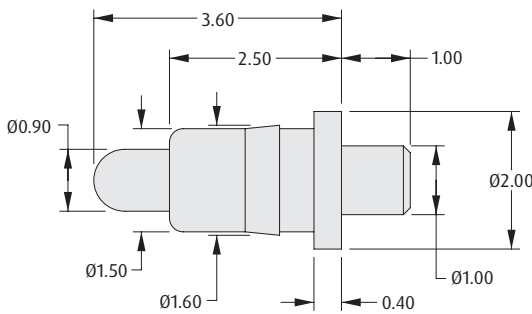

Recommended
PC Board Pattern

ORDER CODE
P70-2000045R

5.0mm FREE HEIGHT

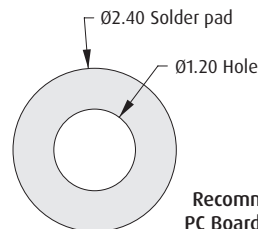
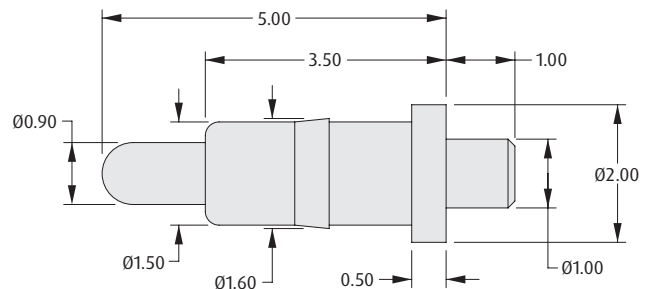

Recommended
PC Board Pattern

ORDER CODE
P70-2010045R

All dimensions in mm.

Spring Loaded Contacts

Single Spring Loaded Contacts – SMT with Peg

- These pogo pins are intended to be used as surface mount with a location peg, but they can also be used as a throughboard tail version.
- Available in Tape and Reeled packaging format for automated assembly methods.
- Gold finish for improved wear resistance.
- Additional height options shown on previous page.

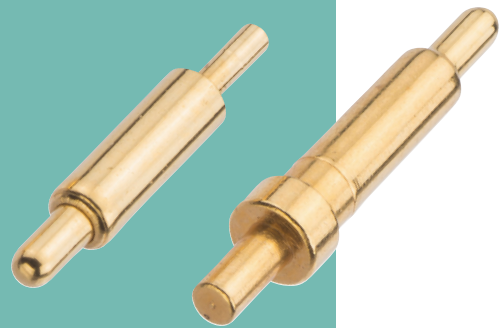

⚡ Packaging

Reel quantity

P70-2100045R:	600 on a Ø330mm reel
P70-2300045R:	580 on a Ø330mm reel
P70-2200045:	Loose

⚡ Electrical

Current: 2A

⚡ Mechanical

Spring force at working height

P70-2100045R:	0.68N ±0.24N at 4.50mm working height
P70-2300045R:	0.83N ±0.25N at 4.90mm working height
P70-2200045:	0.98 ±0.19N at 7.10mm working height

5.5mm FREE HEIGHT

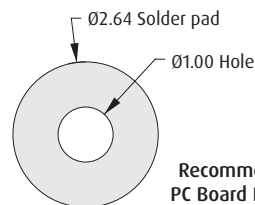
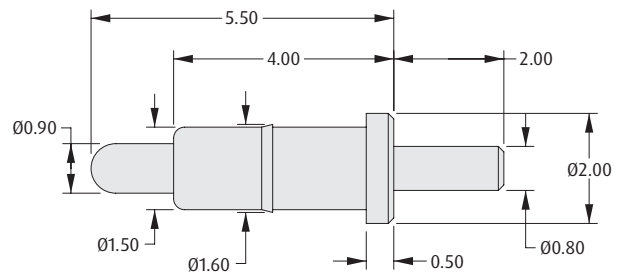

Recommended PC Board Pattern

ORDER CODE
P70-2100045R

6.2mm FREE HEIGHT

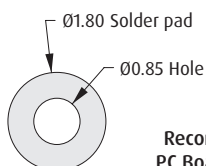
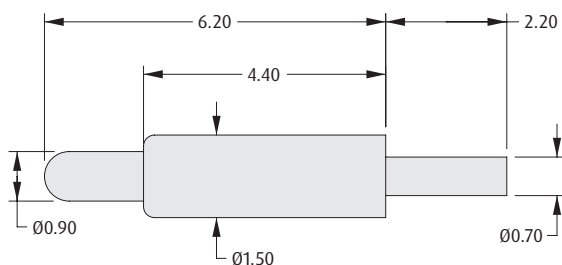

Recommended PC Board Pattern

ORDER CODE
P70-2300045R

8.2mm FREE HEIGHT

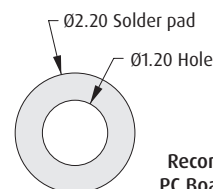
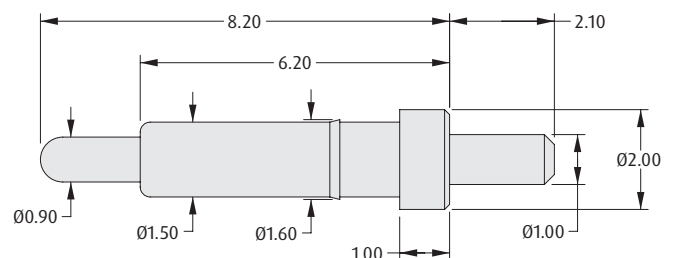

Recommended PC Board Pattern

ORDER CODE
P70-2200045

All dimensions in mm.

Spring Loaded Contacts

Single Spring Loaded Contacts – Surface Mount

- ❖ Also referred to as Pogo pins, used for individual contacts or irregular layout requirements.
- ❖ Available in Tape and Reeled packaging format for automated assembly methods.
- ❖ Gold finish for improved wear resistance.
- ❖ Additional height options shown on following page.



❖ Packaging

Reel quantity

P70-5000045R: 2,000 on a Ø330mm reel
 P70-7000045: Loose
 P70-5100045: Loose

❖ Electrical

Current

P70-5000045R: 1A
 P70-7000045: 2A
 P70-5100045: 2A

❖ Mechanical

Spring force at working height

P70-5000045R: 0.68N ±0.19N at 1.90mm working height
 P70-7000045: 0.68N ±0.19N at 2.00mm working height
 P70-5100045: 0.98N ±0.29N at 4.00mm working height

2.4mm FREE HEIGHT

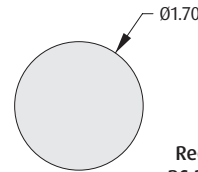
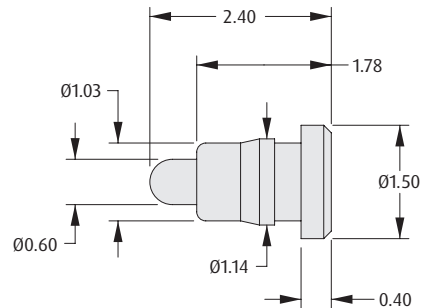

Recommended
PC Board Pattern

ORDER CODE
P70-5000045R

2.5mm FREE HEIGHT

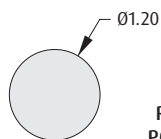
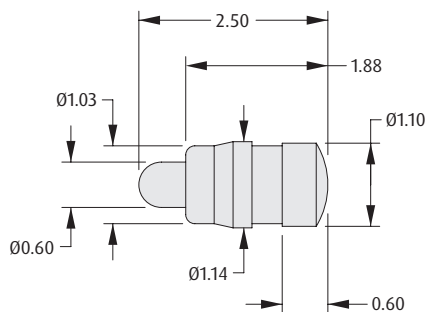

Recommended
PC Board Pattern

ORDER CODE
P70-7000045

4.8mm FREE HEIGHT

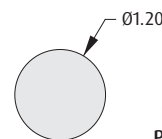
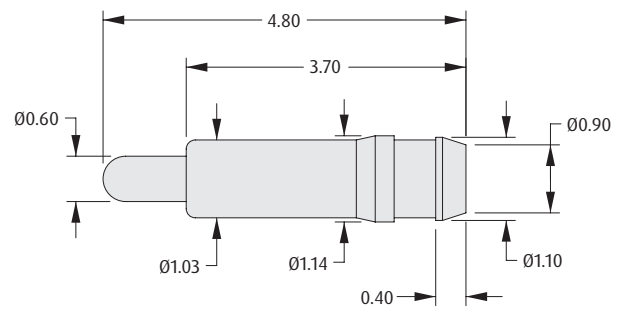

Recommended
PC Board Pattern

ORDER CODE
P70-5100045

All dimensions in mm.

Spring Loaded Contacts

Single Spring Loaded Contacts – Surface Mount

- Also referred to as Pogo pins, used for individual contacts or irregular layout requirements.
- Available in Tape and Reeled packaging format for automated assembly methods.
- Gold finish for improved wear resistance.
- Additional height options shown on following page.



➤ Packaging

Reel Quantity

P70-1100045R:	650 on a Ø330mm reel
P70-1030045R:	650 on a Ø330mm reel
P70-1000045R:	1,400 on a Ø330mm reel
P70-1010045R:	800 on a Ø330mm reel
P70-1020045R:	700 on a Ø330mm reel

➤ Electrical

Current: 2A

➤ Mechanical

Spring force at working height

P70-1100045R:	1.23N ±0.34N at 5.00mm working height
P70-1000045R:	0.88N ±0.29N at 2.90mm working height
P70-1010045R:	1.17N ±0.29N at 4.00mm working height
P70-1020045R:	1.17N ±0.29N/-0.19N at 4.50mm working height
P70-1030045R:	1.29N ±0.29N at 6.20mm working height

6.3mm FREE HEIGHT

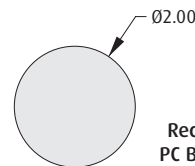
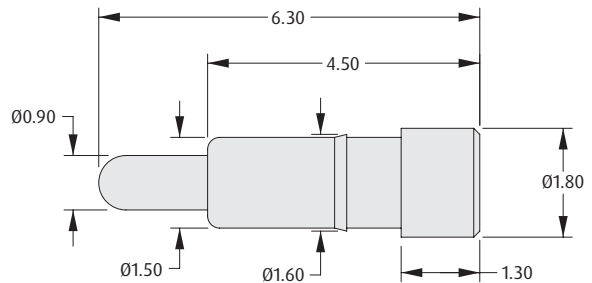

Recommended
PC Board Pattern

ORDER CODE

P70-1100045R

3.5mm TO 7.3mm FREE HEIGHT

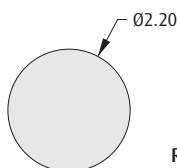
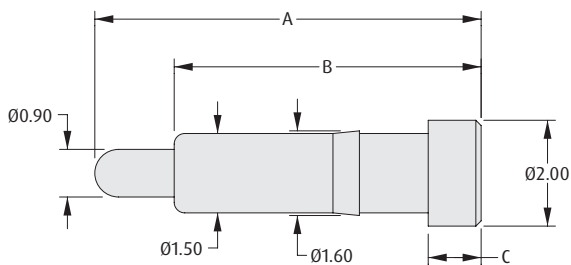

Recommended PC Board Pattern

ORDER CODE	DIM A	DIM B	DIM C
P70-1000045R	3.50	2.50	0.40
P70-1010045R	5.00	3.50	0.50
P70-1020045R	5.50	4.00	0.50
P70-1030045R	7.30	5.80	1.00

All dimensions in mm.

Contact Pads

Surface Mount Contacts

- Surface mountable contact pad, ideal as a mating area for Spring Contacts, Spring Loaded Contacts and Spring Loaded Contact Connectors.
- Available in Tape and Reeled packaging format for automated assembly methods.
- Gold finish for improved wear resistance.
- Available in 3 shapes, with a choice of pad dimensions.



Materials

Base material: Beryllium Copper
 Finish: Gold

Electrical

Current: 6A
 Contact resistance: 0.15mΩ max

Environmental

Operating temperature: -40°C to +85°C

CIRCULAR

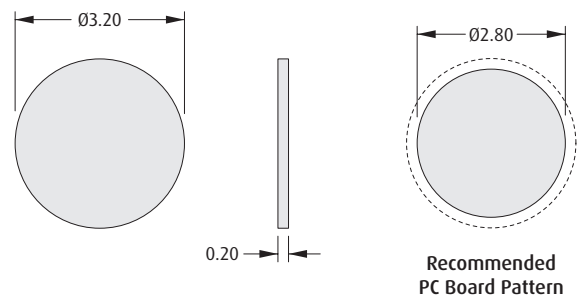

ORDER CODE	TAPE & REEL
S70-332002045R	2,000 on a Ø178 reel

RECTANGULAR

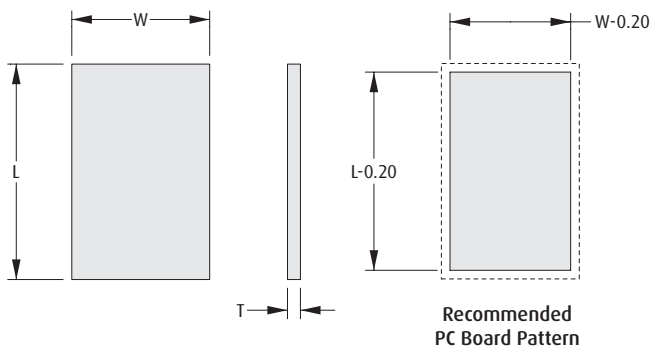

ORDER CODE	DIM L	DIM W	DIM T	TAPE & REEL
S70-125161545R	2.50	1.60	0.15	4,000 on a Ø178 reel
S70-138181045R	3.80	1.80	0.10	2,000 on a Ø178 reel
S70-138305045R	3.80	3.00	0.50	2,000 on a Ø178 reel

OVAL

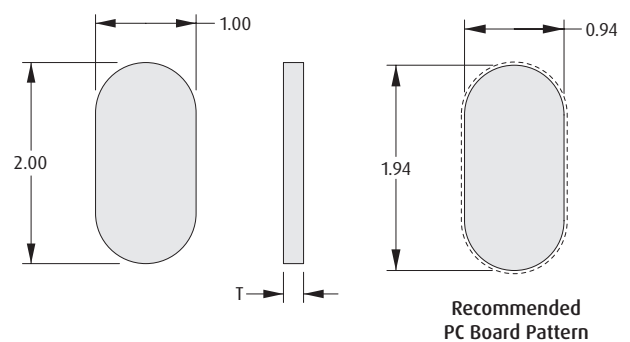

ORDER CODE	DIM T	TAPE & REEL
S70-220101045R	0.10	9,000 on a Ø178 reel
S70-220102045R	0.20	9,000 on a Ø178 reel

All dimensions in mm.

