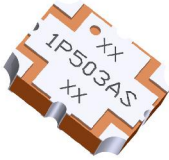


# Xinger®

## Hybrid Couplers 3 dB, 90°



### Description

The 1P503AS Pico Xinger is a low profile, high performance 3dB hybrid coupler in an easy to use manufacturing friendly surface mount package. It is designed for DCS and PCS applications. The 1P503AS is designed for balanced amplifiers, variable phase shifters and attenuators, LNAs, signal distribution and is an ideal solution for the ever-increasing demands of the wireless industry for smaller printed circuit boards and high performance. Parts have been subjected to rigorous qualification testing and they are manufactured using materials with coefficients of thermal expansion (CTE) compatible with common substrates such as FR4, G-10, RF-35, RO4003 and polyimide. Produced with 6 of 6 RoHS compliant tin immersion finish.

### Features:

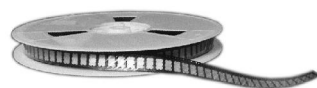
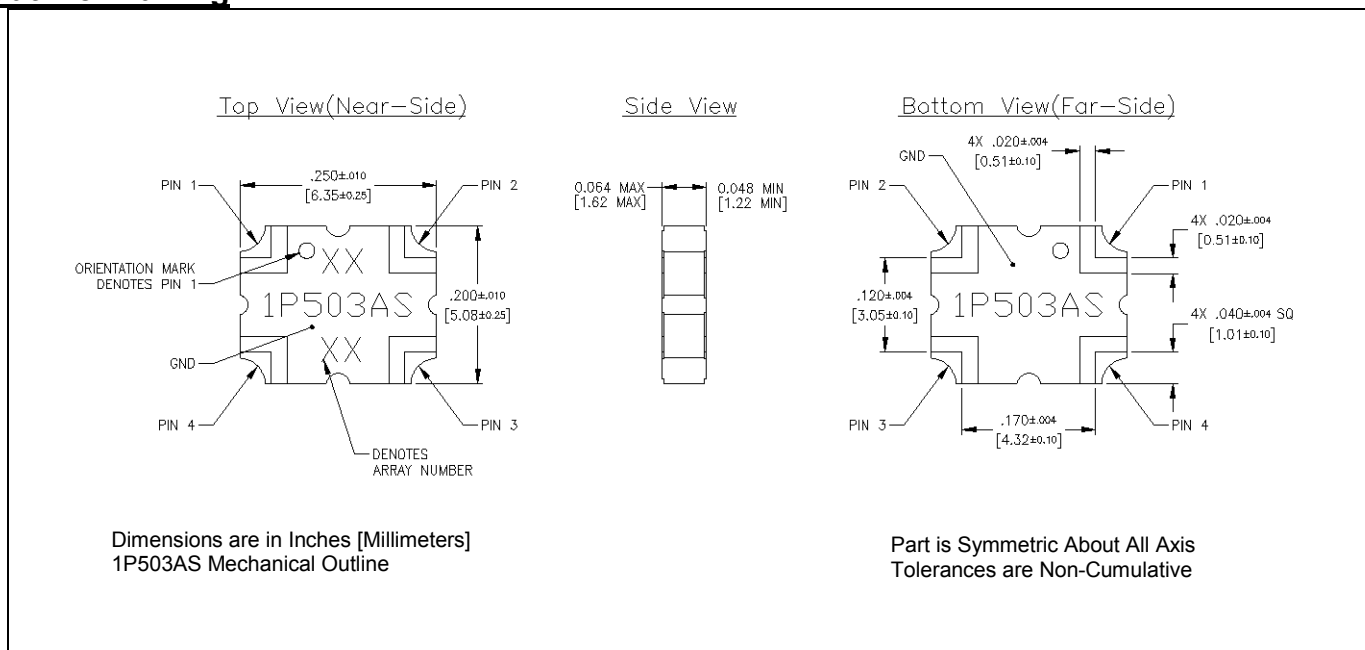
- 1.7 – 2.0 GHz.
- DCS and PCS
- Low Loss
- High Isolation
- 90° Quadrature
- Surface Mountable
- Tape And Reel
- Lead Free
- 100% Tested

### ELECTRICAL SPECIFICATIONS\*\*

Frequency	Isolation*	Insertion Loss	VSWR		
GHz	dB Min	dB Max	Max:1		
1.7 – 1.8	18	0.25	1.28		
1.8 – 2.0	18	0.25	1.28		
Amplitude Balance	Phase Balance	Power	ΘJC	Operating Temp.	
dB Max	Degrees	Ave. CW Watts	°C/Watt	°C	
± 0.45	± 3	30	27.5	-55 to +85	
± 0.30	± 3	30	27.5	-55 to +85	

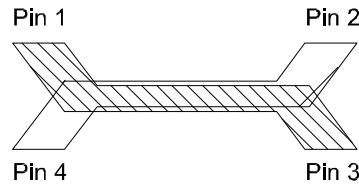
\*\*Specification based on performance of unit properly installed on microstrip printed circuit boards with 50 Ω nominal impedance. Specifications subject to change without notice.

### Outline Drawing



## Hybrid Coupler Pin Configuration

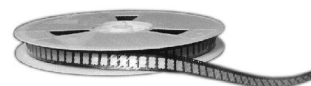
The 1P503AS has an orientation marker to denote Pin 1. Once port one has been identified the other ports are known automatically. Please see the chart below for clarification:



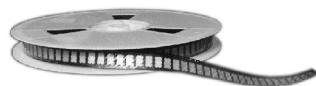
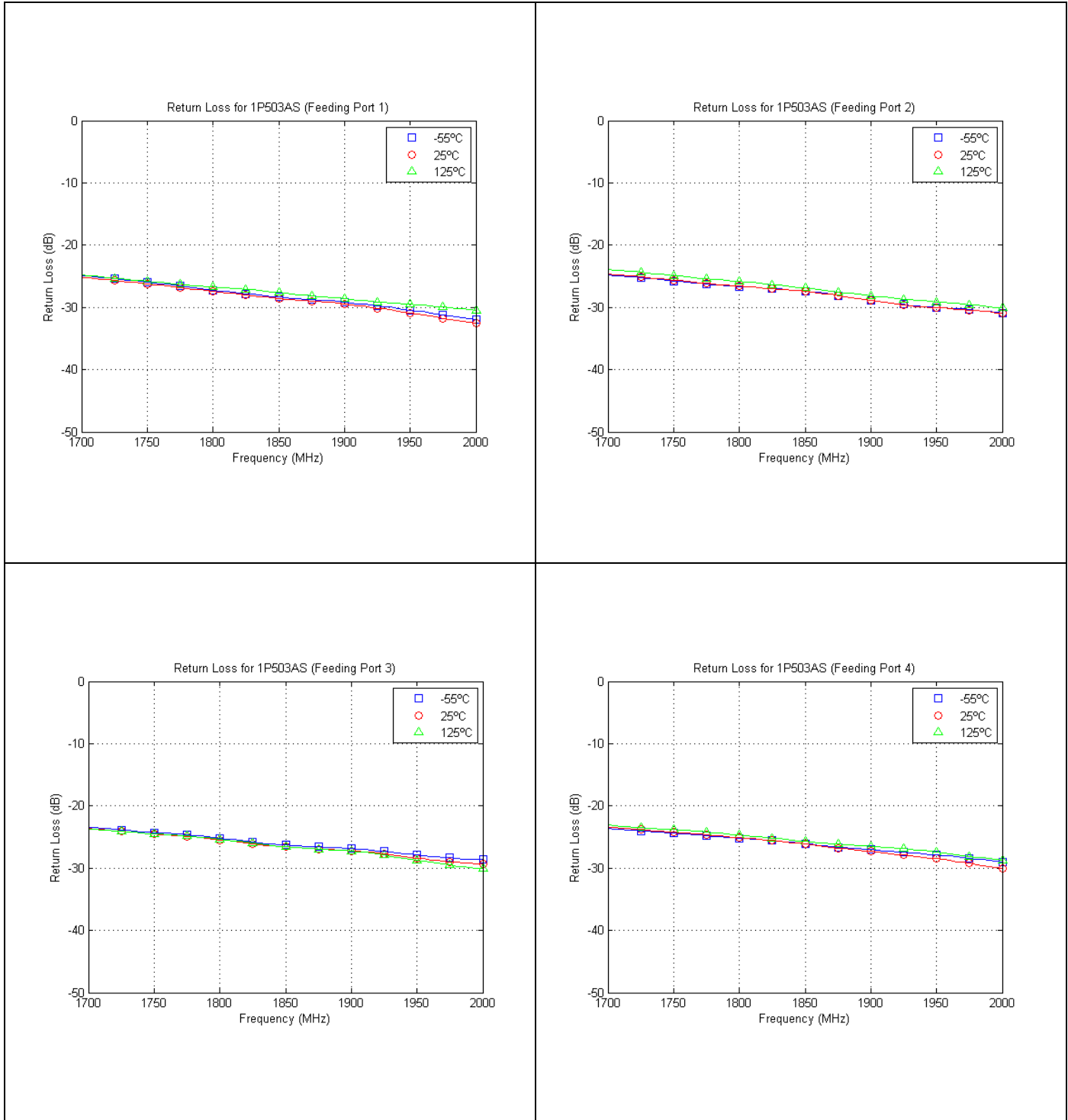
Configuration	Pin 1	Pin 2	Pin 3	Pin 4
<b>Splitter</b>	Input	Isolated	-3dB $\angle \theta - 90$	-3dB $\angle \theta$
<b>Splitter</b>	Isolated	Input	-3dB $\angle \theta$	-3dB $\angle \theta - 90$
<b>Splitter</b>	-3dB $\angle \theta - 90$	-3dB $\angle \theta$	Input	Isolated
<b>Splitter</b>	-3dB $\angle \theta$	-3dB $\angle \theta - 90$	Isolated	Input
<b>*Combiner</b>	$A \angle \theta - 90$	$A \angle \theta$	Isolated	Output
<b>*Combiner</b>	$A \angle \theta$	$A \angle \theta - 90$	Output	Isolated
<b>*Combiner</b>	Isolated	Output	$A \angle \theta - 90$	$A \angle \theta$
<b>*Combiner</b>	Output	Isolated	$A \angle \theta$	$A \angle \theta - 90$

\*Notes: “A” is the amplitude of the applied signals. When two quadrature signals with equal amplitudes are applied to the coupler as described in the table, they will combine at the output port. If the amplitudes are not equal, some of the applied energy will be directed to the isolated port.

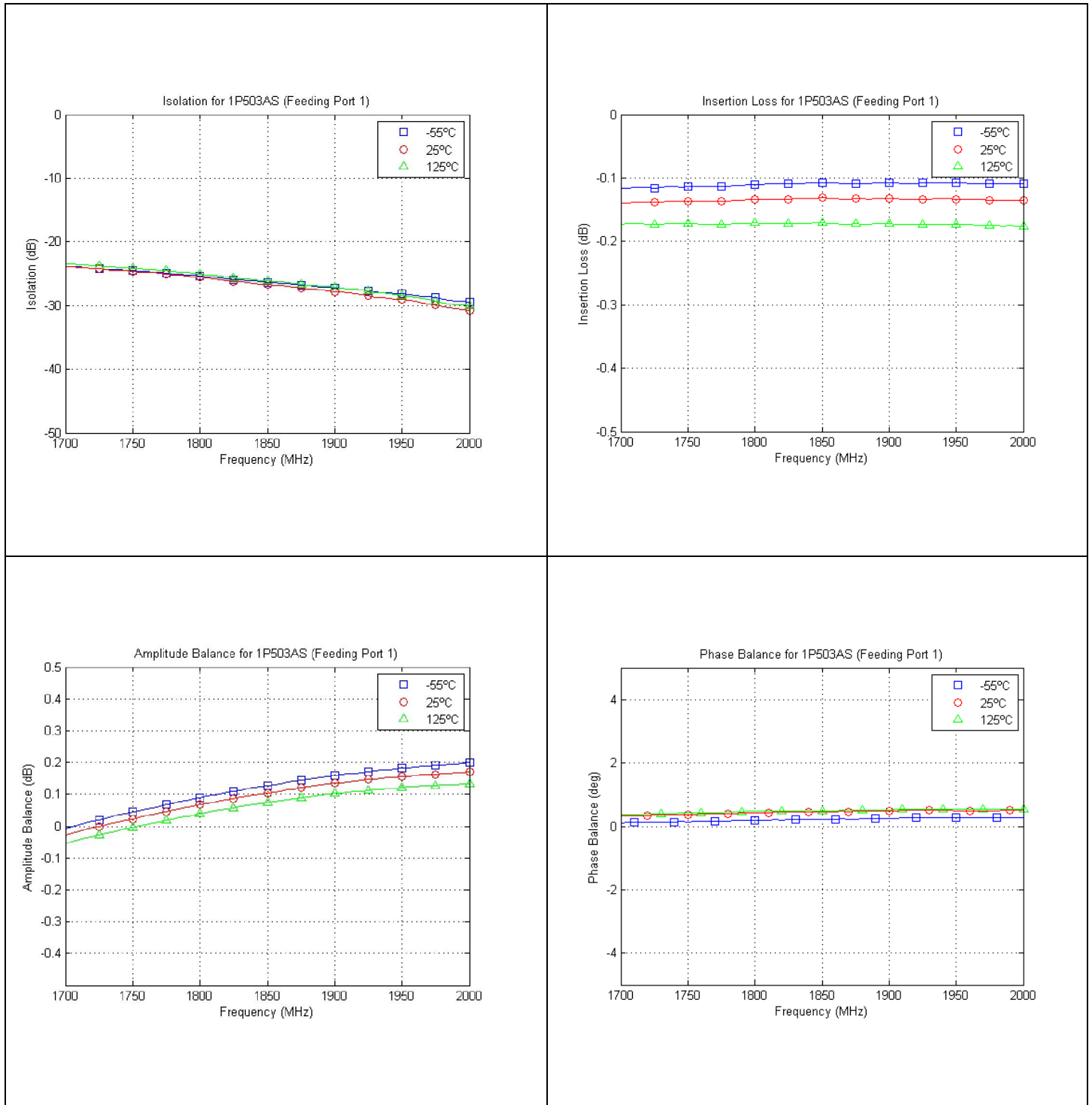
The actual phase,  $\angle \theta$ , or amplitude at a given frequency for all ports, can be seen in our de-embedded s-parameters, that can be downloaded at [www.anaren.com](http://www.anaren.com).



## Typical Performance (-55°C, 25°C & 125°C): 1700 - 2000 MHz



## Typical Performance (-55°C, 25°C & 125°C): 1700 - 2000 MHz



USA/Canada: (315) 432-8909  
 Toll Free: (800) 544-2414  
 Europe: +44 2392-232392

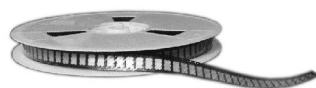
Available on Tape and Reel For Pick and Place Manufacturing.



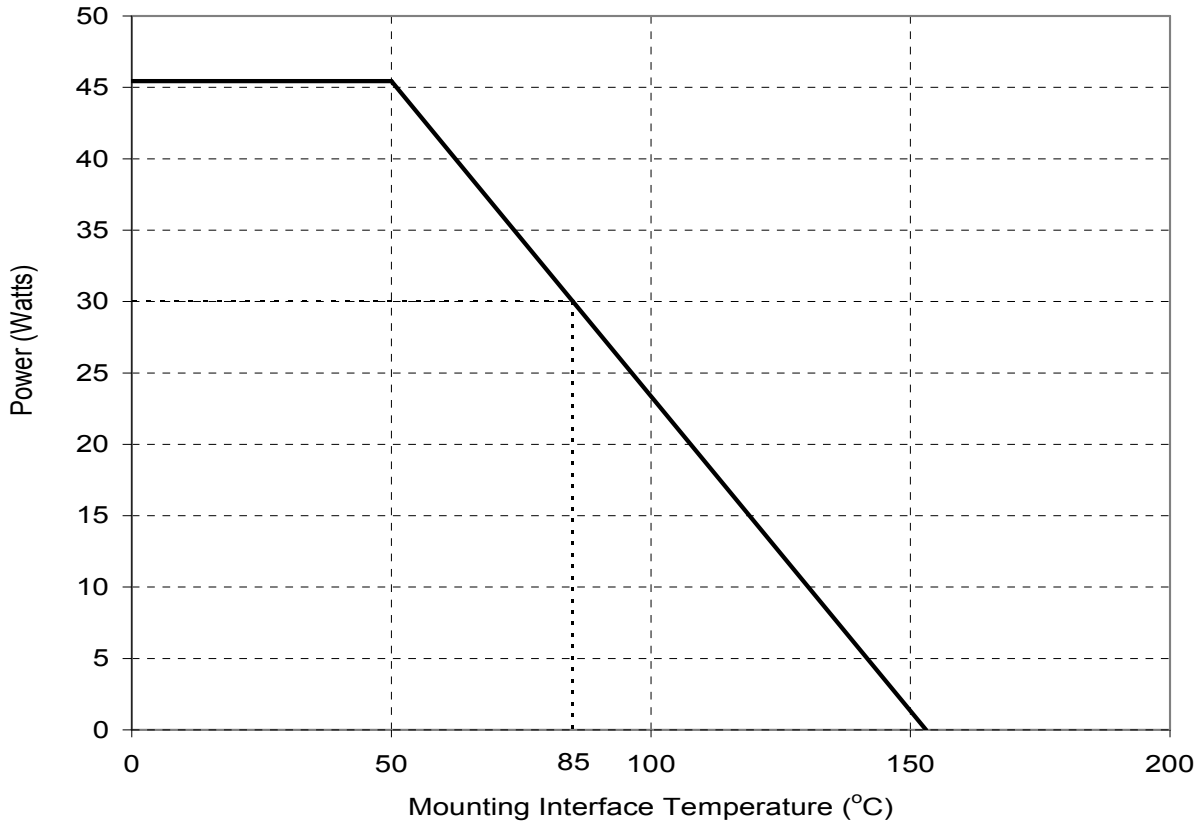
**Anaren**  
 What'll we think of next

### Definition of Measured Specifications

Parameter	Definition	Mathematical Representation
<b>VSWR</b> (Voltage Standing Wave Ratio)	The impedance match of the coupler to a 50Ω system. A VSWR of 1:1 is optimal.	$VSWR = \frac{V_{max}}{V_{min}}$ Vmax = voltage maxima of a standing wave Vmin = voltage minima of a standing wave
<b>Return Loss</b>	The impedance match of the coupler to a 50Ω system. Return Loss is an alternate means to express VSWR.	$\text{Return Loss (dB)} = 20 \log \frac{VSWR + 1}{VSWR - 1}$
<b>Insertion Loss</b>	The input power divided by the sum of the power at the two output ports.	$\text{Insertion Loss (dB)} = 10 \log \frac{P_{in}}{P_{cpl} + P_{direct}}$
<b>Isolation</b>	The input power divided by the power at the isolated port.	$\text{Isolation (dB)} = 10 \log \frac{P_{in}}{P_{iso}}$
<b>Phase Balance</b>	The difference in phase angle between the two output ports.	Phase at coupled port – Phase at direct port
<b>Amplitude Balance</b>	The power at each output divided by the average power of the two outputs.	$10 \log \left( \frac{P_{cpl}}{P_{cpl} + P_{direct}} \right) \text{ and } 10 \log \left( \frac{P_{direct}}{P_{cpl} + P_{direct}} \right)$



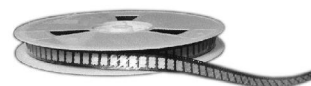
## 1P503AS Power Derating Curve



### Power Derating:

The power handling and corresponding power derating plots are a function of the thermal resistance, mounting surface temperature (base plate temperature), maximum continuous operating temperature of the coupler, and the thermal insertion loss. The thermal insertion loss is defined in the Power Handling section of the data sheet.

As the mounting interface temperature approaches the maximum continuous operating temperature, the power handling decreases to zero.



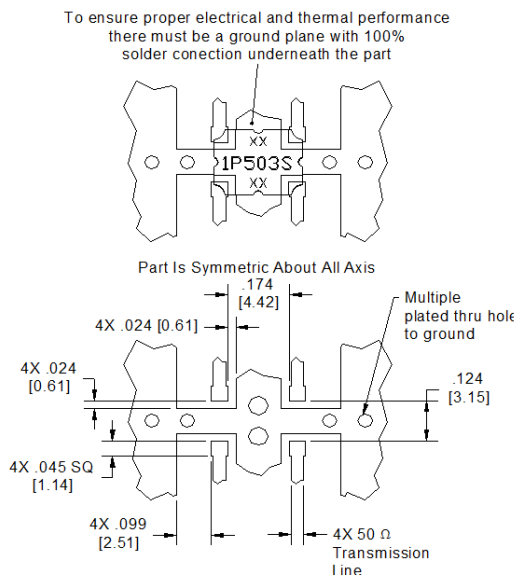
### Mounting

In order for Xinger surface mount couplers to work optimally, there must be 50Ω transmission lines leading to and from all of the RF ports. Also, there must be a very good ground plane underneath the part to ensure proper electrical performance. If either of these two conditions is not satisfied, electrical performance may not meet published specifications.

Overall ground is improved if a dense population of plated through holes connect the top and bottom ground layers of the PCB. This minimizes ground inductance and improves ground continuity. All of the Xinger hybrid and directional couplers are constructed from ceramic filled PTFE composites which possess excellent electrical and mechanical stability having X and Y thermal coefficient of expansion (CTE) of 17-25 ppm/°C.

When a surface mount hybrid coupler is mounted to a printed circuit board, the primary concerns are; ensuring the RF pads of the device are in contact with the circuit trace of the PCB and insuring the ground plane of neither the component nor the PCB is in contact with the RF signal.

### Mounting Footprint



Dimensions are in Inches [Millimeters]

### Coupler Mounting Process

The process for assembling this component is a conventional surface mount process as shown in Figure 1. This process is conducive to both low and high volume usage.

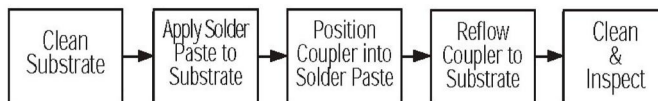


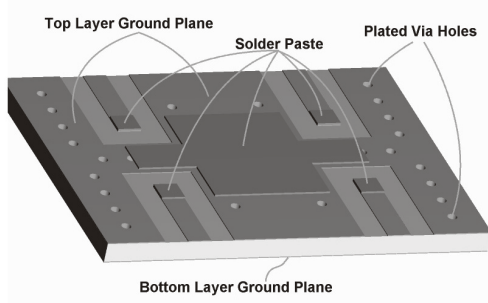
Figure 1: Surface Mounting Process Steps

**Storage of Components:** Xinger products are available in either an immersion tin or tin-lead finish. Commonly used storage procedures used to control oxidation should be followed for these surface mount components. The storage temperatures should be held between 15°C and 60°C.

**Substrate:** Depending upon the particular component, the circuit material has an x and y coefficient of thermal expansion of between 17 and 25 ppm/°C. This coefficient minimizes solder joint stresses due to similar expansion rates of most commonly used board substrates such as RF35, RO4003, FR4, polyimide and G-10 materials. Mounting to “hard” substrates (alumina etc.) is possible depending upon operational temperature requirements. The solder surfaces of the coupler are all copper plated with either an immersion tin or tin-lead exterior finish.

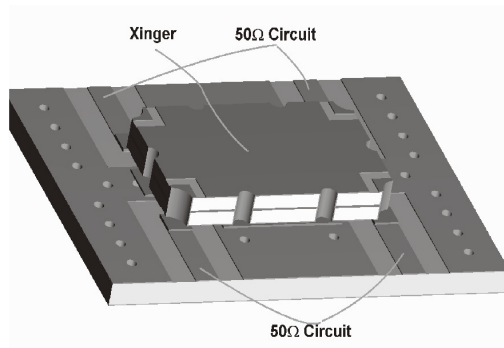
**Solder Paste:** All conventional solder paste formulations will work well with Anaren’s Xinger surface mount components. Solder paste can be applied with stencils or syringe dispensers. An example of a stenciled solder paste deposit is shown in Figure 2. As shown in the figure solder paste is applied to the four RF pads and the entire ground plane underneath the body of the part.



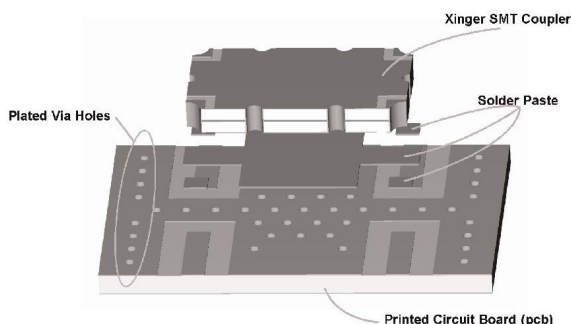


**Figure 2: Solder Paste Application**

**Coupler Positioning:** The surface mount coupler can be placed manually or with automatic pick and place mechanisms. Couplers should be placed (see Figure 3 and 4) onto wet paste with common surface mount techniques and parameters. Pick and place systems must supply adequate vacuum to hold a 0.106 gram coupler.



**Figure 3: Component Placement**



**Figure 4: Mounting Features Example**

**Reflow:** The surface mount coupler is conducive to most of today's conventional reflow methods. A low and high temperature thermal reflow profile are shown in Figures 5 and 6, respectively. Manual soldering of these components can be done with conventional surface mount non-contact hot air soldering tools. Board pre-heating is highly recommended for these selective hot air soldering methods. Manual soldering with conventional irons should be avoided.





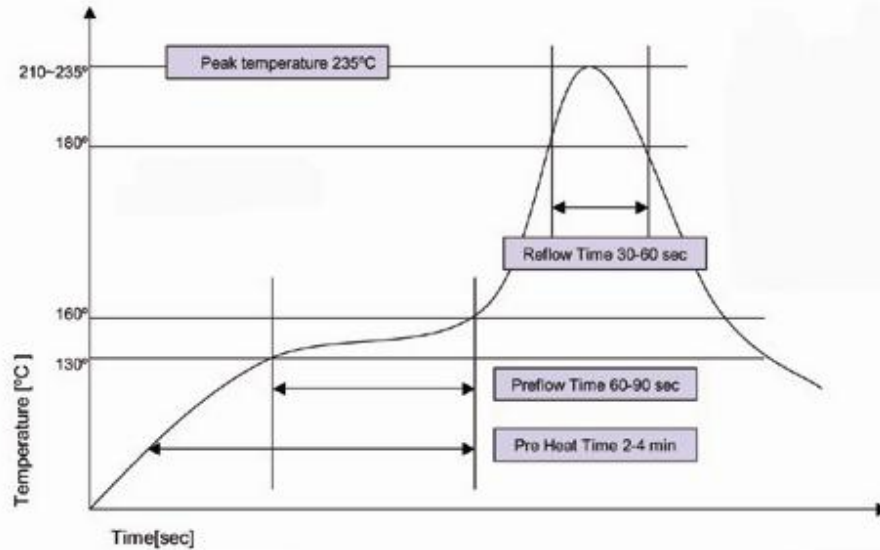


Figure 5 – Low Temperature Solder Reflow Thermal Profile

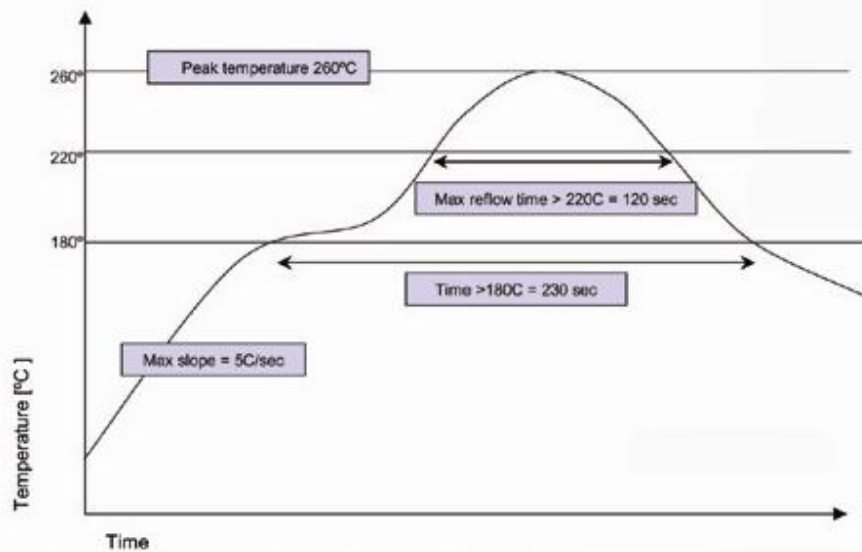
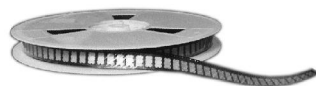
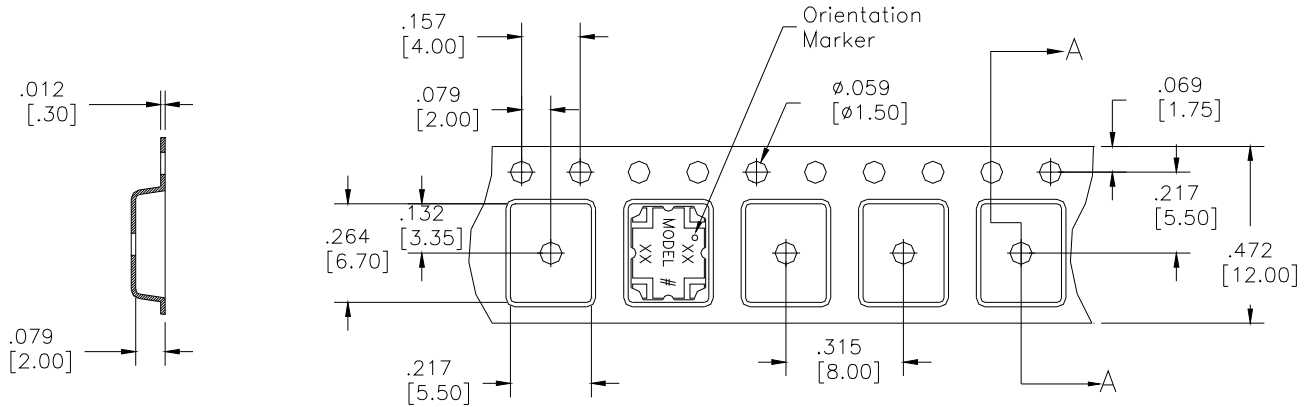


Figure 6 – High Temperature Solder Reflow Thermal Profile



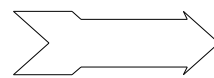
## Packaging and Ordering Information

Packaging follows EIA-481-2. Parts are oriented in tape as shown below. Minimum order quantities are 2000 per reel.



SECTION A-A

Dimensions are in inches [mm]



Direction of Part Feed (Unloading)

## Xinger® Tape & Reel Diagram

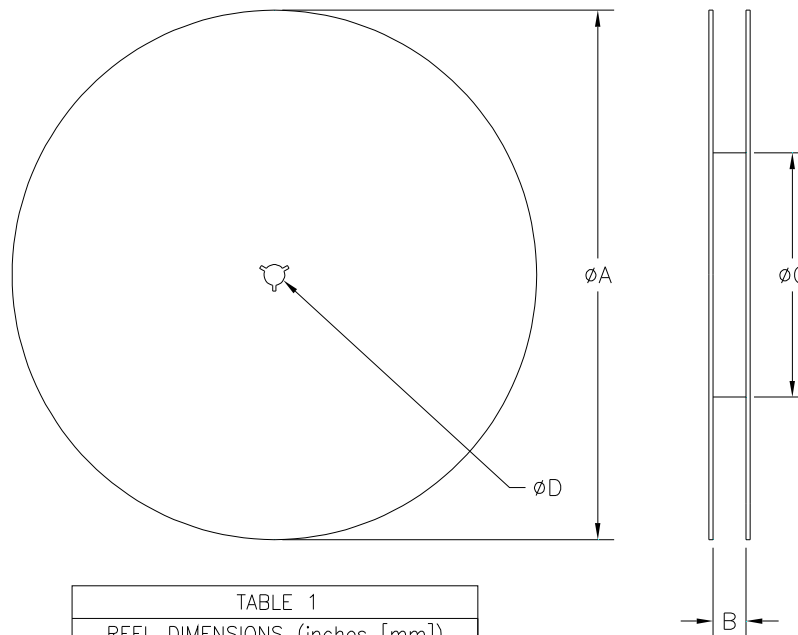
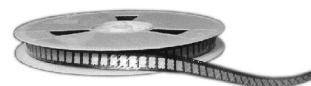


TABLE 1	
REEL DIMENSIONS (inches [mm])	
$\phi A$	13.3 [333.0]
B	0.472 [12.0]
$\phi C$	4.017 [102.03]
$\phi D$	0.512 [13.0]

USA/Canada: (315) 432-8909  
 Toll Free: (800) 544-2414  
 Europe: +44 2392-232392

Available on Tape and Reel For Pick and Place Manufacturing.



# Anaren

What'll we think of next