

High Voltage Power MOSFETs

N-Channel Enhancement Mode
Avalanche Rated, High dv/dt

IXTA/IXTP 3N120
IXTA/IXTP 3N110

V_{DSS}	I_{D25}	$R_{DS(on)}$
1200 V	3 A	4.5 Ω
1100 V	3 A	4.0 Ω

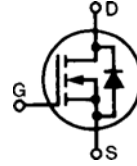

Symbol	Test Conditions	Maximum Ratings		
V_{DSS}	$T_J = 25^\circ\text{C to } 150^\circ\text{C}$	3N120	1200	V
		3N110	1100	V
V_{DGR}	$T_J = 25^\circ\text{C to } 150^\circ\text{C}; R_{GS} = 1 \text{ M}\Omega$	3N120	1200	V
		3N110	1100	V
V_{GS}	Continuous	± 20		V
V_{GSM}	Transient	± 30		V
I_{D25}	$T_C = 25^\circ\text{C}$	3		A
I_{DM}	$T_C = 25^\circ\text{C}$, pulse width limited by T_{JM}	12		A
I_{AR}	$T_C = 25^\circ\text{C}$	3		A
E_{AR}	$T_C = 25^\circ\text{C}$	20		mJ
E_{AS}		700		mJ
dv/dt	$I_S \leq I_{DM}$, $di/dt \leq 100 \text{ A}/\mu\text{s}$, $V_{DD} \leq V_{DSS}$, $T_J \leq 150^\circ\text{C}$, $R_G = 2 \Omega$	5		V/ns
P_D	$T_C = 25^\circ\text{C}$	150		W
T_J		-55 to +150		$^\circ\text{C}$
T_{JM}		150		$^\circ\text{C}$
T_{stg}		-55 to +150		$^\circ\text{C}$
T_L	1.6 mm (0.063 in) from case for 10 s	300		$^\circ\text{C}$
M_d	Mounting torque (TO-220)	1.13/10		Nm/lb.in.
Weight	TO-220	4		g
	TO-263	2		g

TO-220 (IXTP)

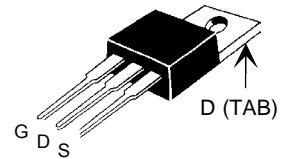

TO-263 (IXTA)

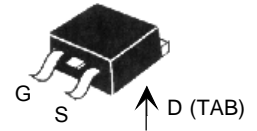

G = Gate D = Drain
S = Source TAB = Drain

Features

- International standard packages
- Low $R_{DS(on)}$
- Rated for unclamped Inductive load Switching (UIS)
- Molding epoxies meet UL 94 V-0 flammability classification

Advantages

- Easy to mount
- Space savings
- High power density

Symbol	Test Conditions	Characteristic Values ($T_J = 25^\circ\text{C}$, unless otherwise specified)		
		min.	typ.	max.
V_{DSS}	$V_{GS} = 0 \text{ V}$, $I_D = 1 \text{ mA}$	3N120	1200	V
		3N110	1100	V
$V_{GS(th)}$	$V_{DS} = V_{GS}$, $I_D = 250 \mu\text{A}$	2.5		4.5 V
I_{GSS}	$V_{GS} = \pm 20 V_{DC}$, $V_{DS} = 0$			$\pm 100 \text{ nA}$
I_{DSS}	$V_{DS} = 0.8 V_{DSS}$, $V_{GS} = 0 \text{ V}$	$T_J = 25^\circ\text{C}$		25 μA
		$T_J = 125^\circ\text{C}$		1 mA
$R_{DS(on)}$	$V_{GS} = 10 \text{ V}$, $I_D = 0.5 I_{D25}$ Note 1	3N120	4.5 Ω	
		3N110	4.0 Ω	

Symbol	Test Conditions	Characteristic Values ($T_J = 25^\circ\text{C}$, unless otherwise specified)		
		min.	typ.	max.
g_{fs}	$V_{DS} = 10\text{ V}; I_D = 0.5 \cdot I_{D25}$, Note 1	1.5	2.2	S
C_{iss}	$V_{GS} = 0\text{ V}, V_{DS} = 25\text{ V}, f = 1\text{ MHz}$		1050	1300 pF
C_{oss}			100	125 pF
C_{rss}			25	50 pF
$t_{d(on)}$	$V_{GS} = 10\text{ V}, V_{DS} = 0.5 \cdot V_{DSS}, I_D = 0.5 \cdot I_{D25}$ $R_G = 4.7\ \Omega$ (External),		17	ns
t_r			15	ns
$t_{d(off)}$			32	ns
t_f			18	ns
$Q_{g(on)}$	$V_{GS} = 10\text{ V}, V_{DS} = 0.5 \cdot V_{DSS}, I_D = 0.5 \cdot I_{D25}$		39	nC
Q_{gs}			9	nC
Q_{gd}			22	nC
R_{thJC}	(TO-220)			0.8 KW
R_{thCK}			0.25	KW

Symbol	Test Conditions	Characteristic Values ($T_J = 25^\circ\text{C}$, unless otherwise specified)		
		min.	typ.	max.
I_S	$V_{GS} = 0\text{ V}$			3 A
I_{SM}	Repetitive; pulse width limited by T_{JM}			12 A
V_{SD}	$I_F = I_S, V_{GS} = 0\text{ V}$, Note 1			1.5 V
t_{rr}	$I_F = I_S, -di/dt = 100\text{ A}/\mu\text{s}, V_R = 100\text{ V}$		700	ns

Notes: 1. Pulse test, $t \leq 300\ \mu\text{s}$, duty cycle $d \leq 2\%$

TO-220 (IXTP) Outline

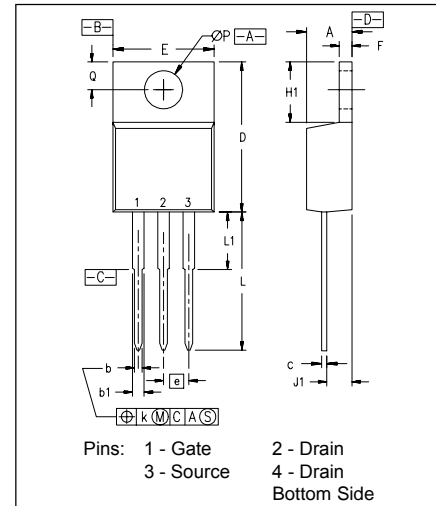

SYM	INCHES		MILLIMETERS	
	MIN	MAX	MIN	MAX
A	.170	.190	4.32	4.83
b	.025	.040	0.64	1.02
b1	.045	.065	1.15	1.65
c	.014	.022	0.35	0.56
D	.580	.630	14.73	16.00
E	.390	.420	9.91	10.66
e	.100 BSC		2.54 BSC	
F	.045	.055	1.14	1.40
H1	.230	.270	5.85	6.85
J1	.090	.110	2.29	2.79
k	0	.015	0	0.38
L	.500	.550	12.70	13.97
L1	.110	.230	2.79	5.84
$\varnothing P$.139	.161	3.53	4.08
Q	.100	.125	2.54	3.18

NOTE: This drawing will meet all dimensions requirement of JEDEC outline TO-220 AB.

TO-263 (IXTA) Outline

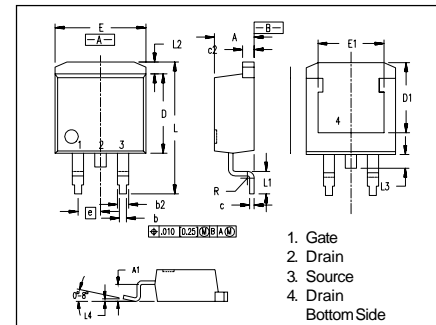

Dim.	Millimeter		Inches	
	Min.	Max.	Min.	Max.
A	4.06	4.83	.160	.190
A1	2.03	2.79	.080	.110
b	0.51	0.99	.020	.039
b2	1.14	1.40	.045	.055
c	0.46	0.74	.018	.029
c2	1.14	1.40	.045	.055
D	8.64	9.65	.340	.380
D1	7.11	8.13	.280	.320
E	9.65	10.29	.380	.405
E1	6.86	8.13	.270	.320
e	2.54	BSC	.100	BSC
L	14.61	15.88	.575	.625
L1	2.29	2.79	.090	.110
L2	1.02	1.40	.040	.055
L3	1.27	1.78	.050	.070
L4	0	0.38	0	.015
R	0.46	0.74	.018	.029

IXYS reserves the right to change limits, test conditions, and dimensions.

IXYS MOSFETs and IGBTs are covered by one or more of the following U.S. patents:

4,835,592	4,881,106	5,017,508	5,049,961	5,187,117	5,486,715	6,306,728B1
4,850,072	4,931,844	5,034,796	5,063,307	5,237,481	5,381,025	

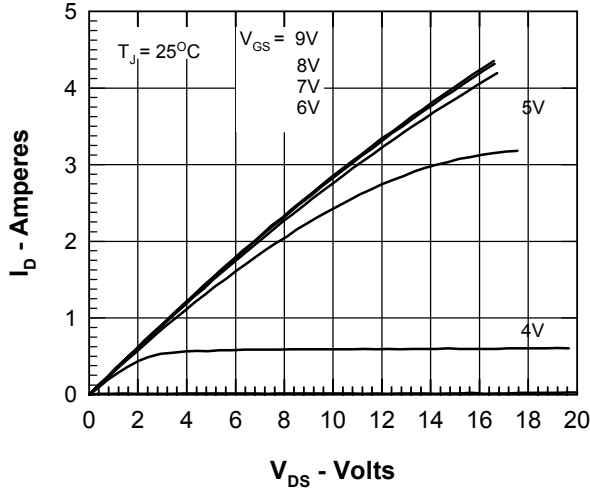

Fig.1 Output Characteristics @ $T_j = 25^\circ\text{C}$

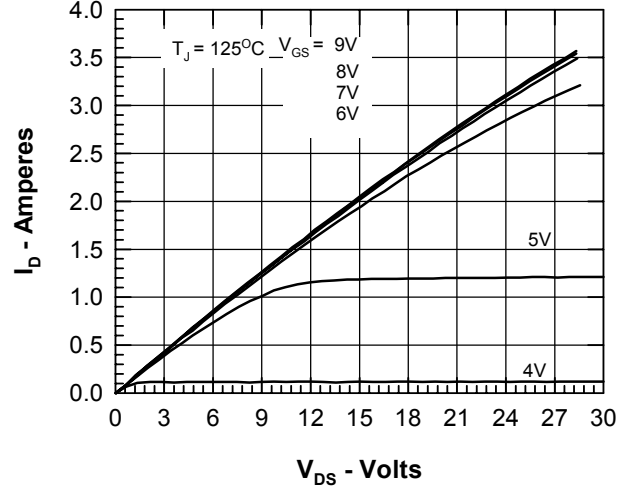

Fig. 2 Output Characteristics @ $T_j = 125^\circ\text{C}$

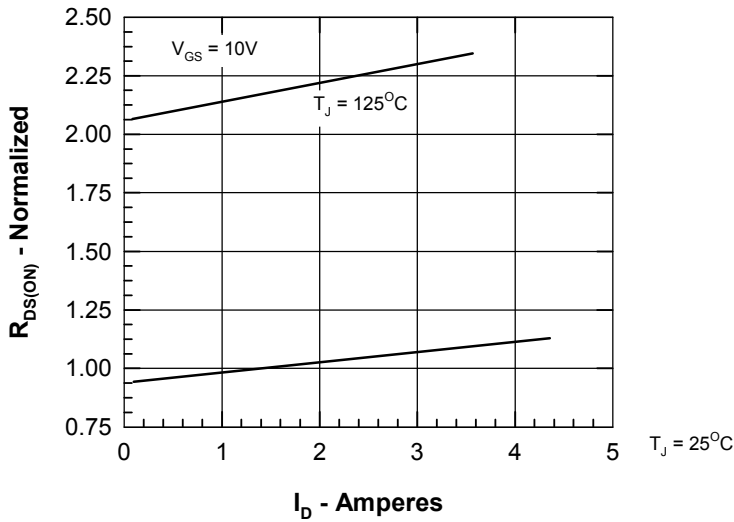

Fig. 3 $R_{DS(on)}$ vs. Drain Current

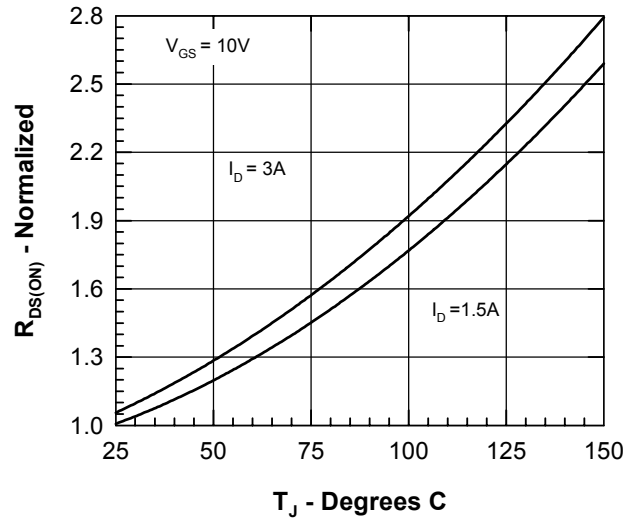

Fig. 4 Temperature Dependence of Drain to Source Resistance

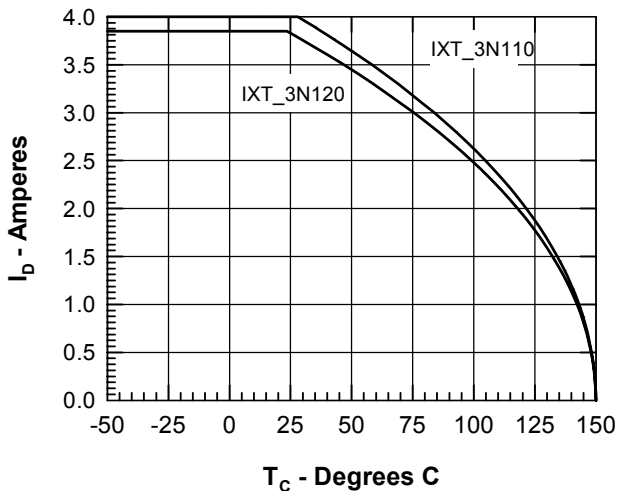

Fig. 5 Drain Current vs. Case Temperature

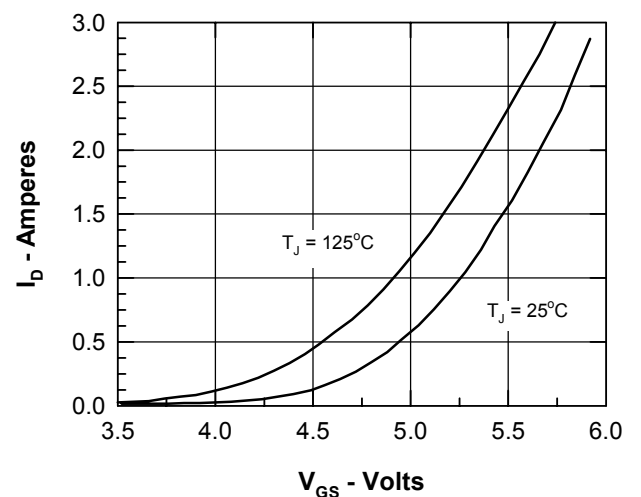

Fig. 6 Admittance Curves

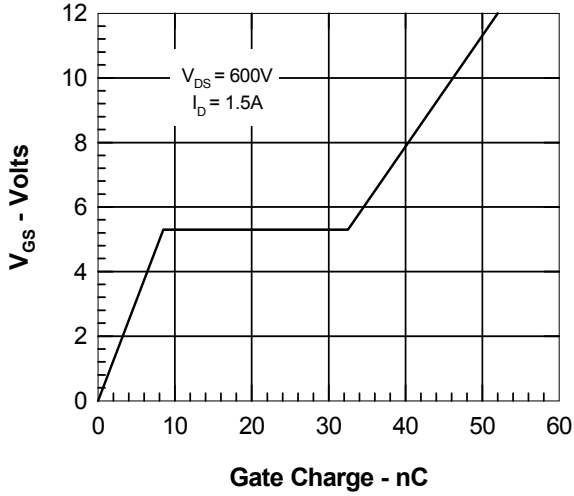

Fig. 7 Gate Charge Characteristic Curve

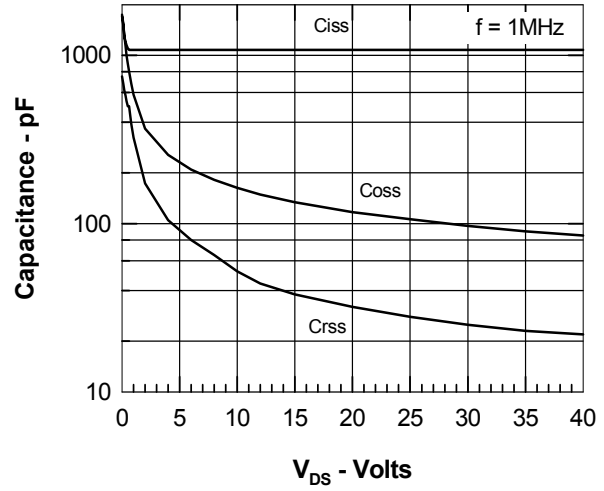

Fig. 8 Capacitance Curves

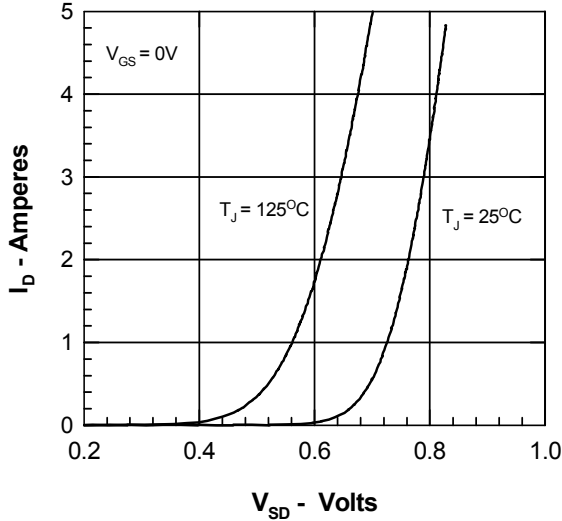

Fig. 9 Drain Current vs Drain to Source Voltage

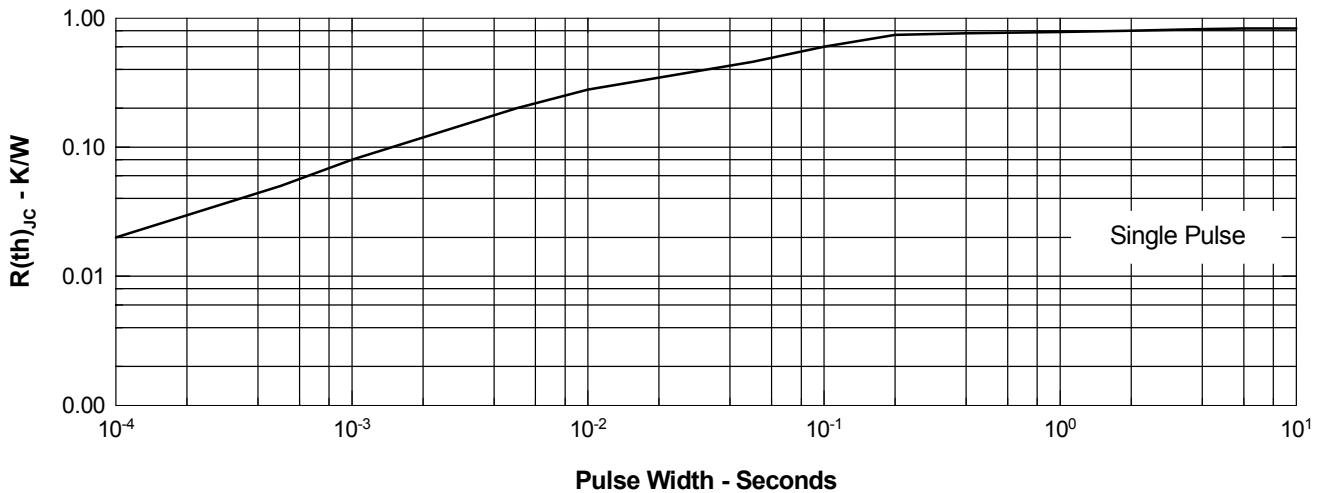

Fig. 10 Transient Thermal Impedance

IXYS reserves the right to change limits, test conditions, and dimensions.

IXYS MOSFETs and IGBTs are covered by one or more of the following U.S. patents:

4,835,592	4,881,106	5,017,508	5,049,961	5,187,117	5,486,715	6,306,728B1
4,850,072	4,931,844	5,034,796	5,063,307	5,237,481	5,381,025	