



The Infinite Bandwidth Company™

# MIC910

## 135MHz Low-Power SOT-23-5 Op Amp

### Final Information

### General Description

The MIC910 is a high-speed, unity-gain stable operational amplifier. It provides a gain-bandwidth product of 135MHz with a very low, 2.4mA supply current, and features the tiny SOT-23-5 package.

Supply voltage range is from ±2.5V to ±9V, allowing the MIC910 to be used in low-voltage circuits or applications requiring large dynamic range.

The MIC910 is stable driving any capacitive load and achieves excellent PSRR, making it much easier to use than most conventional high-speed devices. Low supply voltage, low power consumption, and small packing make the MIC910 ideal for portable equipment. The ability to drive capacitive loads also makes it possible to drive long coaxial cables.

### Features

- 135MHz gain bandwidth product
- 2.4mA supply current
- Unconditionally unity-gain stable
- SOT-23-5 package
- 270V/μs slew rate
- drives any capacitive load

### Applications

- Video
- Imaging
- Ultrasound
- Portable equipment
- Line drivers

### Ordering Information

Part Number	Junction Temp. Range	Package
MIC910BM5	-40°C to +85°C	SOT-23-5

### Pin Configuration

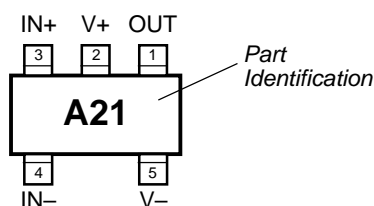

SOT-23-5

### Functional Pinout

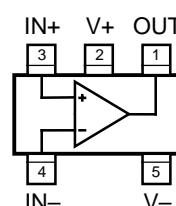

SOT-23-5

### Pin Description

Pin Number	Pin Name	Pin Function
1	OUT	Output: Amplifier Output
2	V+	Positive Supply (Input)
3	IN+	Noninverting Input
4	IN-	Inverting Input
5	V-	Negative Supply (Input)

**Absolute Maximum Ratings (Note 1)**

Supply Voltage ( $V_{V+} - V_{V-}$ )	20V
Differential Input Voltage ( $ V_{IN+} - V_{IN-} $ )	8V, <b>Note 4</b>
Input Common-Mode Range ( $V_{IN+}, V_{IN-}$ )	$V_{V+}$ to $V_{V-}$
Lead Temperature (soldering, 5 sec.)	260°C
Storage Temperature ( $T_S$ )	150°C
ESD Rating, <b>Note 3</b>	1.5kV

**Operating Ratings (Note 2)**

Supply Voltage ( $V_S$ )	$\pm 2.5V$ to $\pm 9V$
Junction Temperature ( $T_J$ )	$-40^\circ C$ to $+85^\circ C$
Package Thermal Resistance	260°C/W

**Electrical Characteristics ( $\pm 5V$ )**

$V_{V+} = +5V$ ,  $V_{V-} = -5V$ ,  $V_{CM} = 0V$ ,  $V_{OUT} = 0V$ ;  $R_L = 10M\Omega$ ;  $T_J = 25^\circ C$ , **bold** values indicate  $-40^\circ C \leq T_J \leq +85^\circ C$ ; unless noted.

Symbol	Parameter	Condition	Min	Typ	Max	Units
$V_{OS}$	Input Offset Voltage			1	<b>15</b>	mV
$V_{OS}$	Input Offset Voltage Temperature Coefficient			4		$\mu V/^\circ C$
$I_B$	Input Bias Current			3.5	5.5 <b>9</b>	$\mu A$ $\mu A$
$I_{OS}$	Input Offset Current			0.05	<b>3</b>	$\mu A$
$V_{CM}$	Input Common-Mode Range	CMRR > 60dB	-3.25		+3.25	V
CMRR	Common-Mode Rejection Ratio	$-2.5V < V_{CM} < +2.5V$	70 <b>60</b>	90		dB dB
PSRR	Power Supply Rejection Ratio	$\pm 5V < V_S < \pm 9V$	74 <b>70</b>	81		dB dB
$A_{VOL}$	Large-Signal Voltage Gain	$R_L = 2k, V_{OUT} = \pm 2V$	<b>60</b>	71		dB
		$R_L = 200\Omega, V_{OUT} = \pm 2V$	<b>60</b>	71		dB
$V_{OUT}$	Maximum Output Voltage Swing	positive, $R_L = 2k\Omega$	+3.3 <b>+3.0</b>	3.5		V V
		negative, $R_L = 2k\Omega$		-3.5	-3.3 <b>-3.0</b>	V V
		positive, $R_L = 200\Omega$	+3.0 <b>+2.75</b>	3.2		V V
		negative, $R_L = 200\Omega$		-2.8	-2.45 <b>-2.2</b>	V V
GBW	Gain-Bandwidth Product	$R_L = 1k\Omega$		125		MHz
BW	-3dB Bandwidth	$A_V = 1, R_L = 100\Omega$		192		MHz
SR	Slew Rate			230		V/ $\mu s$
$I_{GND}$	Short-Circuit Output Current	source		72		mA
		sink		25		mA
$I_{GND}$	Supply Current			2.4	3.5 <b>4.1</b>	mA mA

**Electrical Characteristics**

$V_{V+} = +9V$ ,  $V_{V-} = -9V$ ,  $V_{CM} = 0V$ ,  $V_{OUT} = 0V$ ;  $R_L = 10M\Omega$ ;  $T_J = 25^\circ C$ , **bold** values indicate  $-40^\circ C \leq T_J \leq +85^\circ C$ ; unless noted.

Symbol	Parameter	Condition	Min	Typ	Max	Units
$V_{OS}$	Input Offset Voltage			1	<b>15</b>	mV
$V_{OS}$	Input Offset Voltage Temperature Coefficient			4		$\mu V/^\circ C$
$I_B$	Input Bias Current			3.5	5.5 <b>9</b>	$\mu A$ $\mu A$
$I_{OS}$	Input Offset Current			0.05	<b>3</b>	$\mu A$

Symbol	Parameter	Condition	Min	Typ	Max	Units
$V_{CM}$	Input Common-Mode Range	CMRR > 60dB	-7.25		+7.25	V
CMRR	Common-Mode Rejection Ratio	$-6.5V < V_{CM} < 6.5V$	70 <b>60</b>	98		dB dB
$A_{VOL}$	Large-Signal Voltage Gain	$R_L = 2k\Omega, V_{OUT} = \pm 6V$	<b>60</b>	73		dB
$V_{OUT}$	Maximum Output Voltage Swing	positive, $R_L = 2k\Omega$	+7.2 <b>+6.8</b>	+7.4		V V
		negative, $R_L = 2k\Omega$		-7.4	-7.2 <b>-6.8</b>	V V
GBW	Gain-Bandwidth Product	$R_L = 1k\Omega$		135		MHz
SR	Slew Rate			270		V/ $\mu$ s
$I_{GND}$	Short-Circuit Output Current	source		90		mA
		sink		32		mA
$I_{GND}$	Supply Current			2.5	3.7	mA
					<b>4.3</b>	mA

- Note 1.** Exceeding the absolute maximum rating may damage the device.
- Note 2.** The device is not guaranteed to function outside its operating rating.
- Note 3.** Devices are ESD sensitive. Handling precautions recommended. Human body model, 1.5k in series with 100pF.
- Note 4.** Exceeding the maximum differential input voltage will damage the input stage and degrade performance (in particular, input bias current is likely to increase).

**Test Circuits**

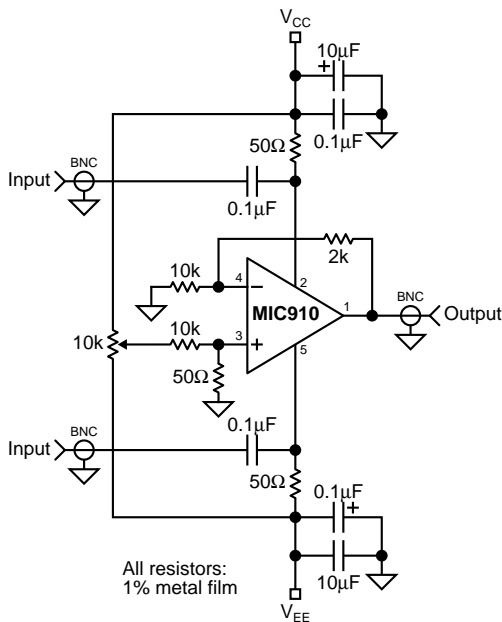

**PSRR vs. Frequency**

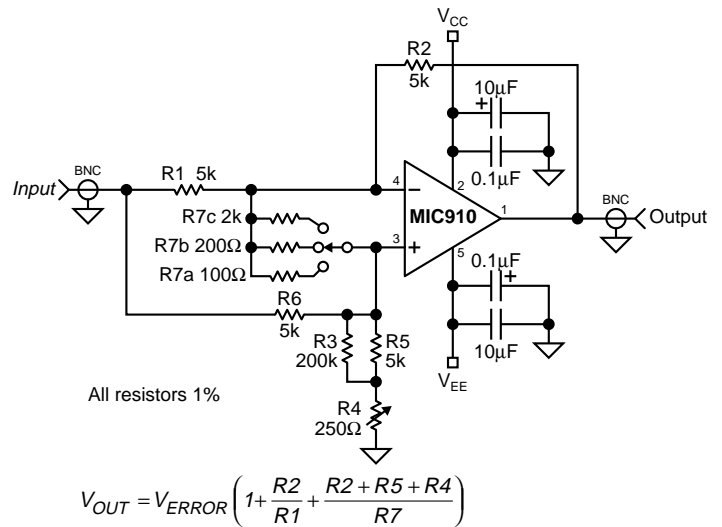

**CMRR vs. Frequency**

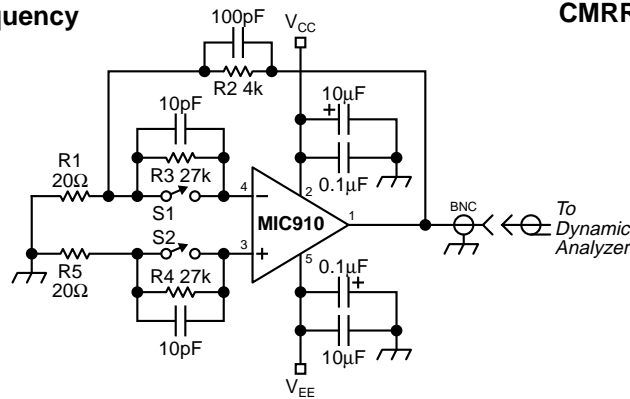

**Noise Measurement**

# Electrical Characteristics

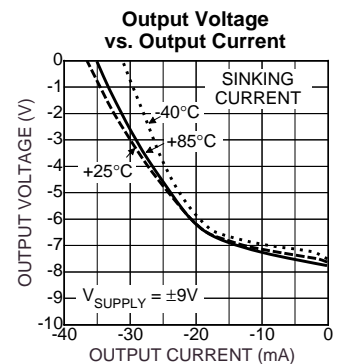
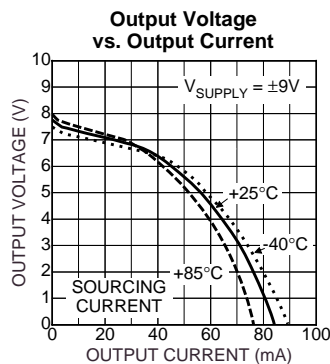
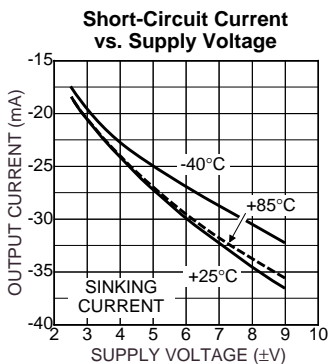
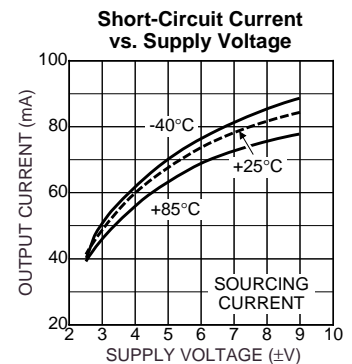
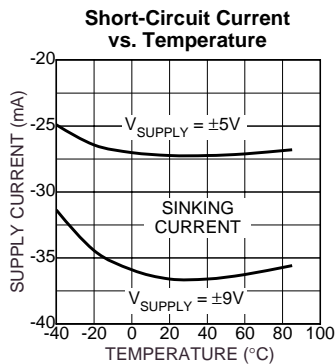
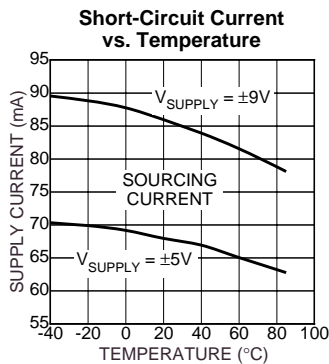
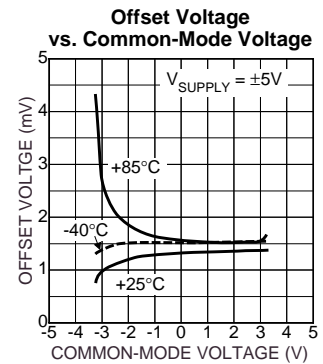
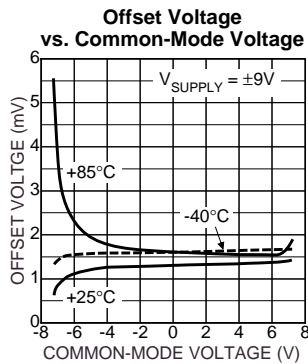
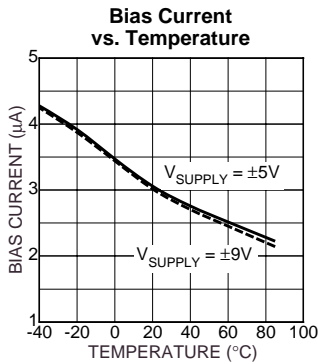
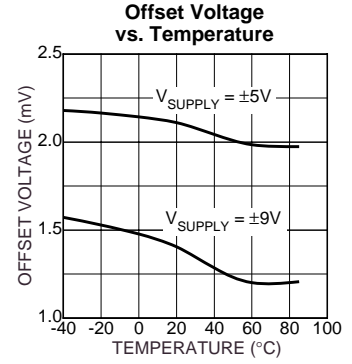
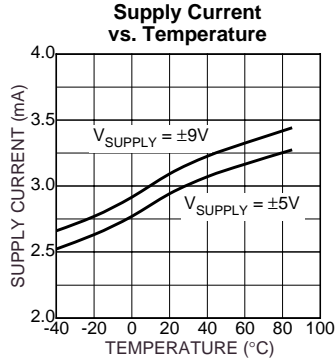
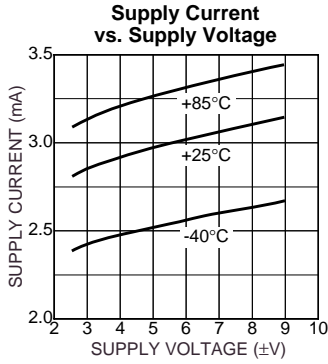

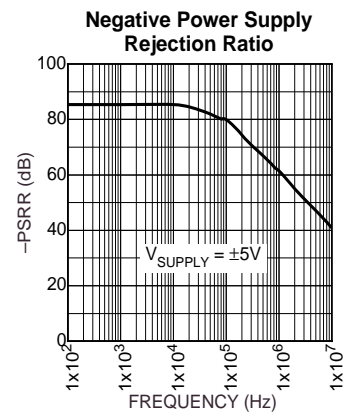
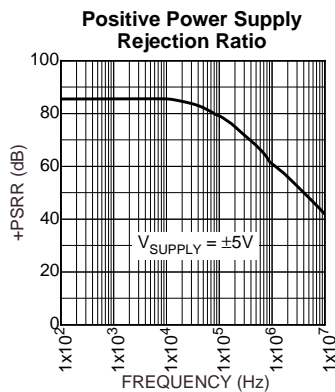
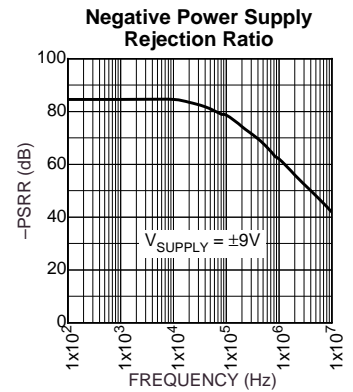
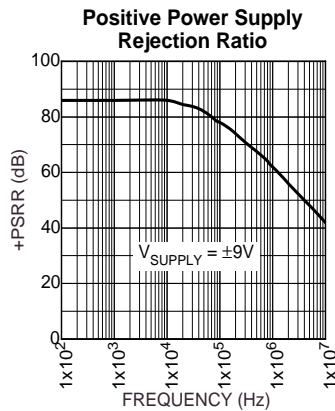
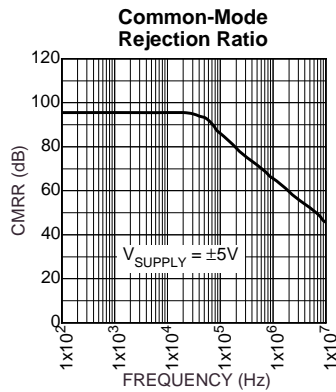
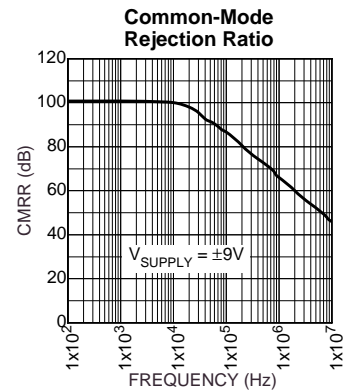
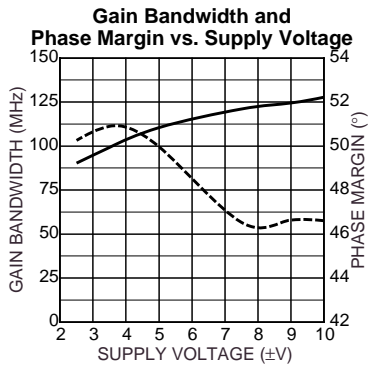
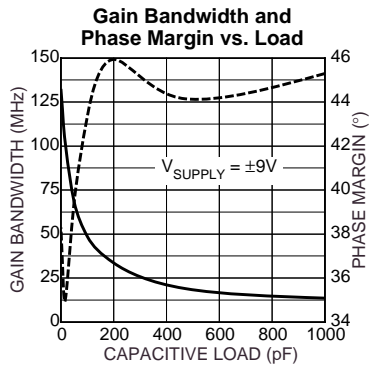
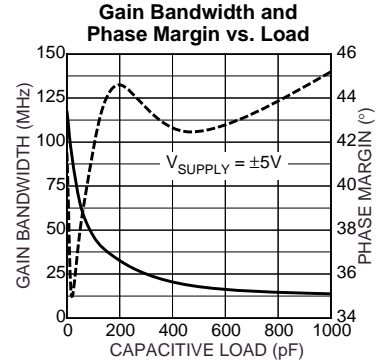
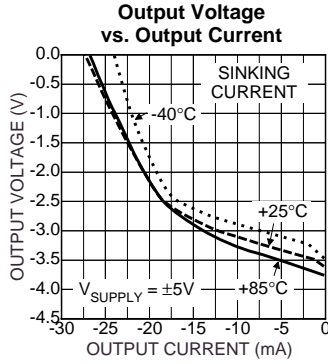
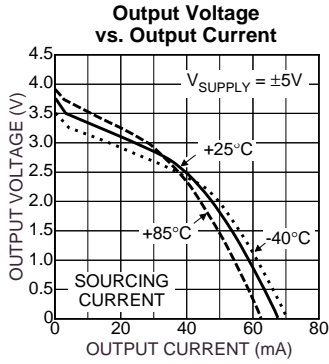

**Closed-Loop Frequency Response Test Circuit**

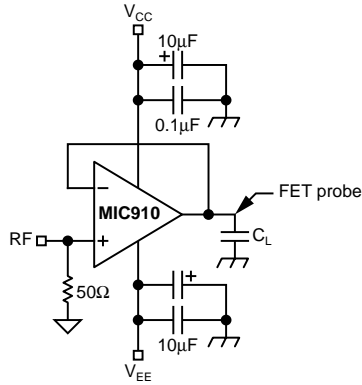

**Closed-Loop Frequency Response**

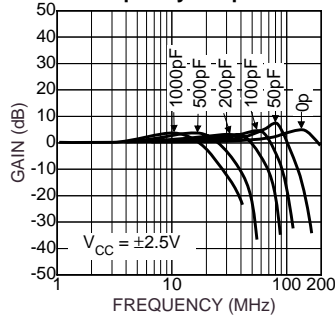

**Open-Loop Frequency Response**

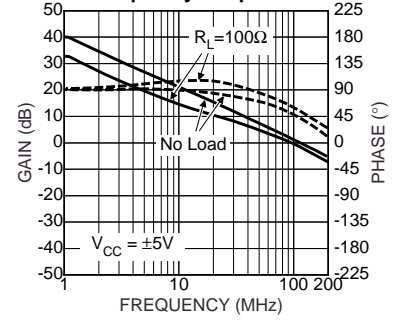

**Closed-Loop Frequency Response**

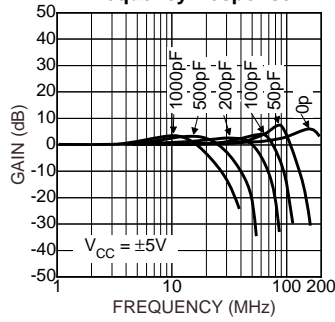

**Open-Loop Frequency Response**

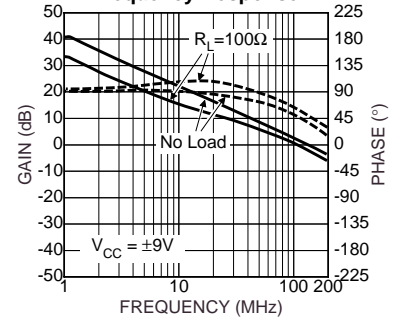

**Voltage Noise**

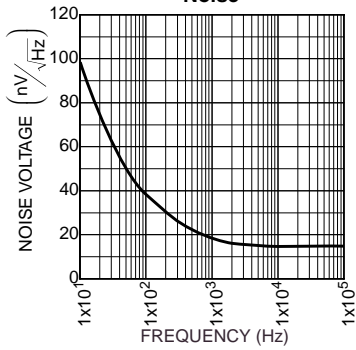

**Positive Slew Rate**

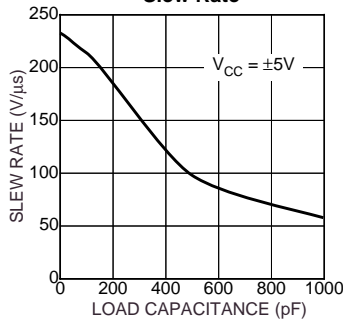

**Negative Slew Rate**

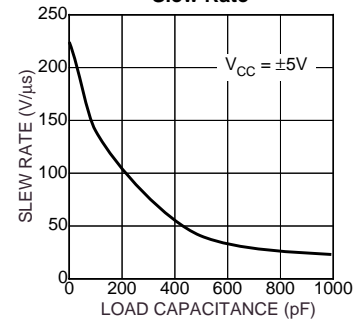

**Current Noise**

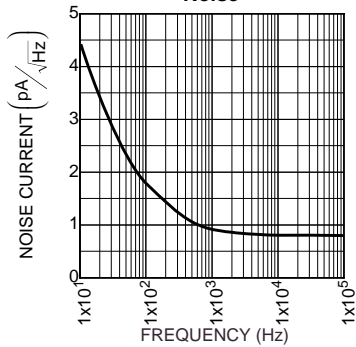

**Positive Slew Rate**

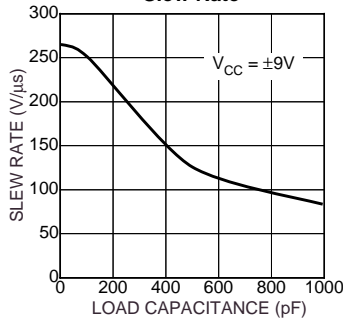

**Negative Slew Rate**

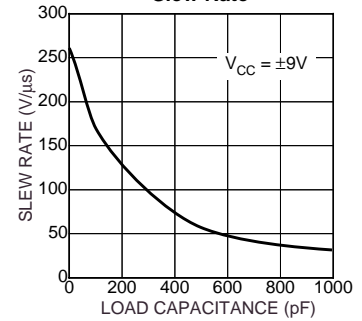

Small-Signal  
Pulse Response

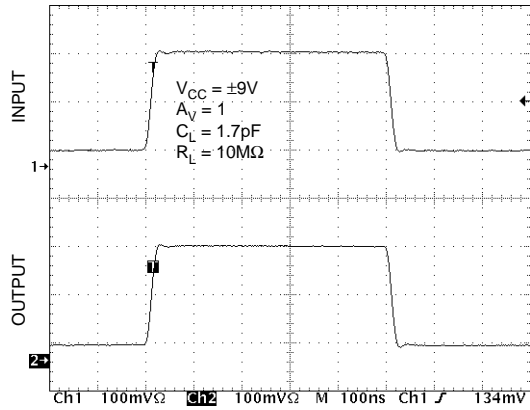

Small-Signal  
Pulse Response

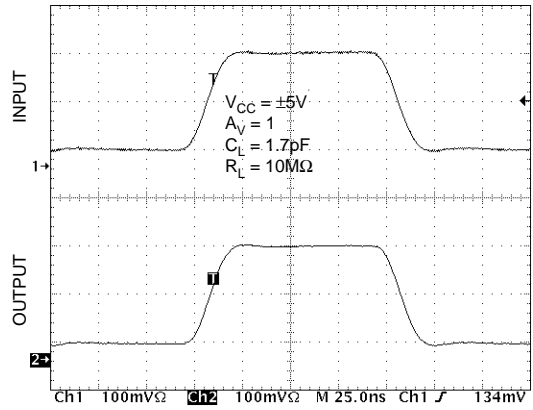

Small-Signal  
Pulse Response

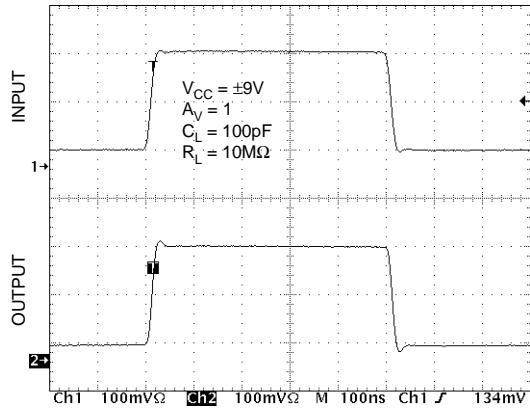

Small-Signal  
Pulse Response

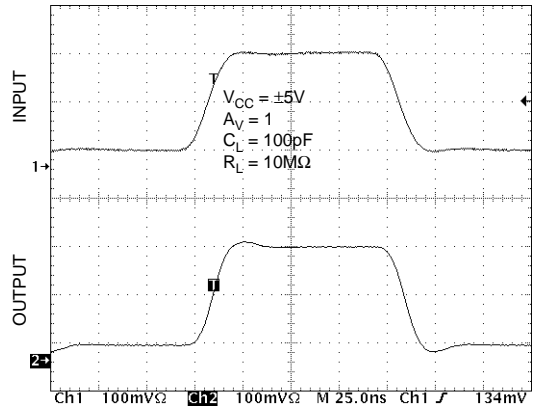

Small-Signal  
Pulse Response

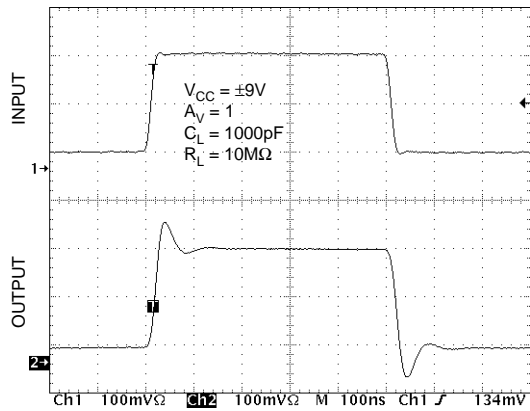

Small-Signal  
Pulse Response

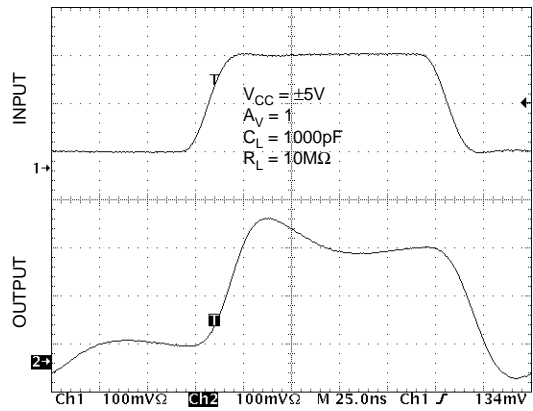

Large-Signal Pulse Response

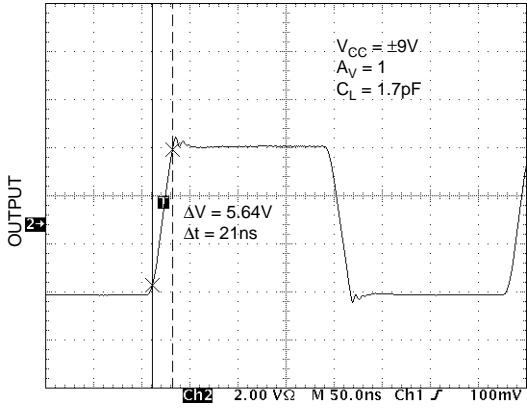

Large-Signal Pulse Response

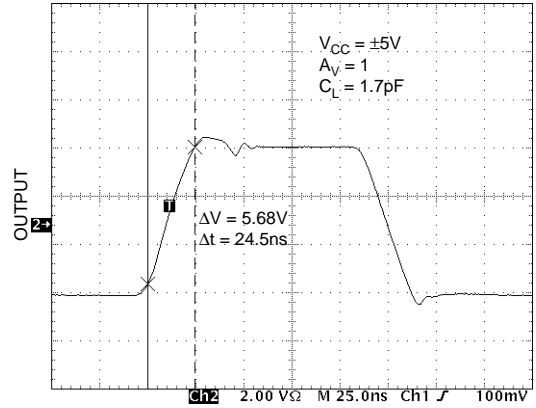

Large-Signal Pulse Response

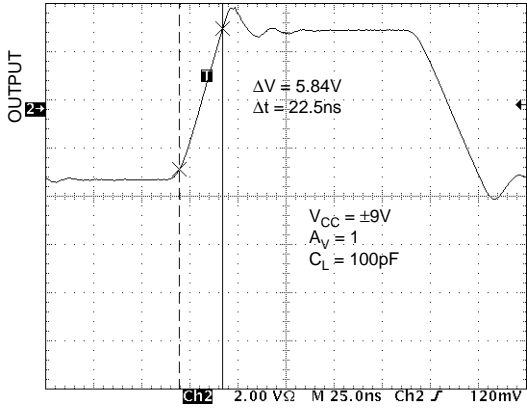

Large-Signal Pulse Response

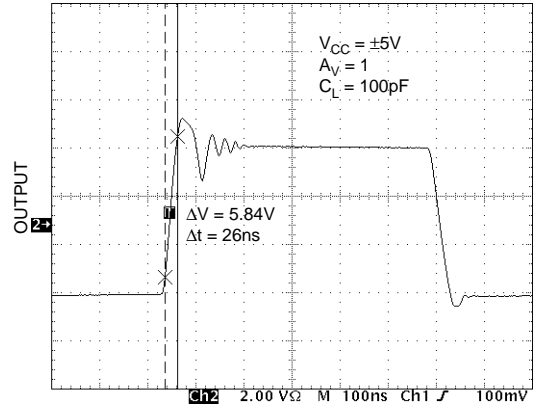

Large-Signal Pulse Response

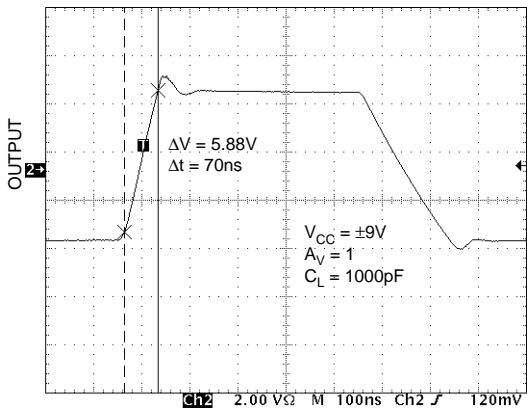

Large-Signal Pulse Response

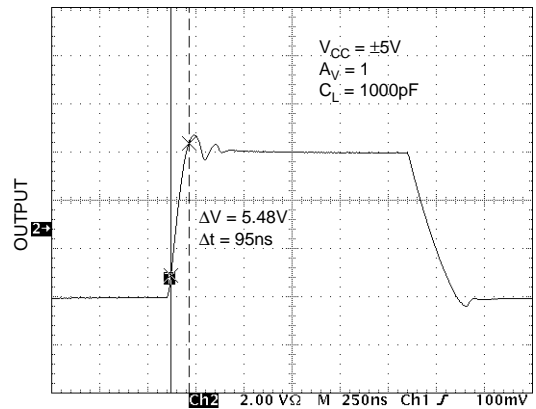



## Applications Information

The MIC910 is a high-speed, voltage-feedback operational amplifier featuring very low supply current and excellent stability. This device is unity gain stable and capable of driving high capacitance loads.

### Driving High Capacitance

The MIC910 is stable when driving any capacitance (see "Typical Characteristics: Gain Bandwidth and Phase Margin vs. Load Capacitance") making it ideal for driving long coaxial cables or other high-capacitance loads.

Phase margin remains constant as load capacitance is increased. Most high-speed op amps are only able to drive limited capacitance.

Note: increasing load capacitance does reduce the speed of the device (see "Typical Characteristics: Gain Bandwidth and Phase Margin vs. Load"). In applications where the load capacitance reduces the speed of the op amp to an unacceptable level, the effect of the load capacitance can be reduced by adding a small resistor (<100Ω) in series with the output.

### Feedback Resistor Selection

Conventional op amp gain configurations and resistor selection apply, the MIC910 is NOT a current feedback device. Resistor values in the range of 1k to 10k are recommended.

### Layout Considerations

All high speed devices require careful PCB layout. The high stability and high PSRR of the MIC910 make this op amp easier to use than most, but the following guidelines should be observed: Capacitance, particularly on the two inputs pins will degrade performance; avoid large copper traces to the inputs. Keep the output signal away from the inputs and use a ground plane.

It is important to ensure adequate supply bypassing capacitors are located close to the device.

## Power Supply Bypassing

Regular supply bypassing techniques are recommended. A 10μF capacitor in parallel with a 0.1μF capacitor on both the positive and negative supplies are ideal. For best performance all bypassing capacitors should be located as close to the op amp as possible and all capacitors should be low ESL (equivalent series inductance), ESR (equivalent series resistance). Surface-mount ceramic capacitors are ideal.

## Thermal Considerations

The SOT-23-5 package, like all small packages, has a high thermal resistance. It is important to ensure the IC does not exceed the maximum operating junction (die) temperature of 85°C. The part can be operated up to the absolute maximum temperature rating of 125°C, but between 85°C and 125°C performance will degrade, in particular CMRR will reduce.

A MIC910 with no load, dissipates power equal to the quiescent supply current \* supply voltage

$$P_{D(no\ load)} = (V_{V+} - V_{V-}) I_S$$

When a load is added, the additional power is dissipated in the output stage of the op amp. The power dissipated in the device is a function of supply voltage, output voltage and output current.

$$P_{D(output\ stage)} = (V_{V+} - V_{OUT}) I_{OUT}$$

$$Total\ Power\ Dissipation = P_{D(no\ load)} + P_{D(output\ stage)}$$

Ensure the total power dissipated in the device is no greater than the thermal capacity of the package. The SOT23-5 package has a thermal resistance of 260°C/W.

$$Max.\ Allowable\ Power\ Dissipation = \frac{T_{J(max)} - T_{A(max)}}{260W}$$



**Package Information**

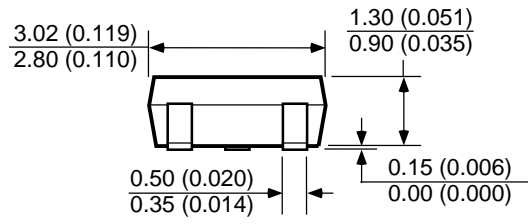
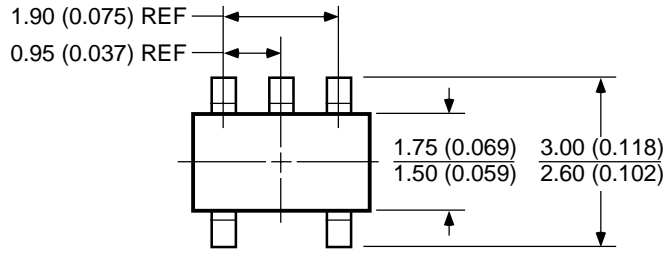

DIMENSIONS:  
MM (INCH)

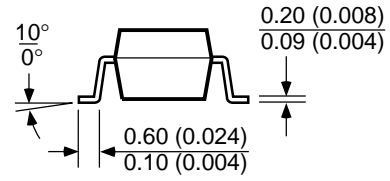

**SOT-23-5 (M5)**

---

**MICREL INC. 1849 FORTUNE DRIVE SAN JOSE, CA 95131 USA**

TEL + 1 (408) 944-0800 FAX + 1 (408) 944-0970 WEB <http://www.micrel.com>

This information is believed to be accurate and reliable, however no responsibility is assumed by Micrel for its use nor for any infringement of patents or other rights of third parties resulting from its use. No license is granted by implication or otherwise under any patent or patent right of Micrel Inc.

© 2001 Micrel Incorporated