

User Manual

PCA-6028

**Intel® Core™ i7/i5/i3/Pentium®
PICMG 1.0 Single Host Board
with VGA/ DVI-D/ DDR3 /SATA3.0
/ USB3.0 / Dual GbE**

ADVANTECH

Enabling an Intelligent Planet

Copyright

The documentation and the software included with this product are copyrighted 2014 by Advantech Co., Ltd. All rights are reserved. Advantech Co., Ltd. reserves the right to make improvements in the products described in this manual at any time without notice. No part of this manual may be reproduced, copied, translated or transmitted in any form or by any means without the prior written permission of Advantech Co., Ltd. Information provided in this manual is intended to be accurate and reliable. However, Advantech Co., Ltd. assumes no responsibility for its use, nor for any infringements of the rights of third parties, which may result from its use.

Acknowledgements

AMIBIOS is a trademark of American Megatrends Inc.

Intel[®], Core™i7/i5/i3 and Pentium[®] are trademarks of Intel[®] Corporation.

Nuvoton is a trademark of Nuvoton Technology Corp.

All other product names or trademarks are the properties of their respective owners.

Product Warranty (2 years)

Advantech warrants to you, the original purchaser, that each of its products will be free from defects in materials and workmanship for two years from the date of purchase.

This warranty does not apply to any products which have been repaired or altered by persons other than repair personnel authorized by Advantech, or which have been subject to misuse, abuse, accident or improper installation. Advantech assumes no liability under the terms of this warranty as a consequence of such events.

Because of Advantech's high quality-control standards and rigorous testing, most of our customers never need to use our repair service. If an Advantech product is defective, it will be repaired or replaced at no charge during the warranty period. For out-of-warranty repairs, you will be billed according to the cost of replacement materials, service time and freight. Please consult your dealer for more details.

If you think you have a defective product, follow these steps:

1. Collect all the information about the problem encountered. (For example, CPU speed, Advantech products used, other hardware and software used, etc.) Note anything abnormal and list any onscreen messages you get when the problem occurs.
2. Call your dealer and describe the problem. Please have your manual, product, and any helpful information readily available.
3. If your product is diagnosed as defective, obtain an RMA (return merchandise authorization) number from your dealer. This allows us to process your return more quickly.
4. Carefully pack the defective product, a fully-completed Repair and Replacement Order Card and a photocopy proof of purchase date (such as your sales receipt) in a shippable container. A product returned without proof of the purchase date is not eligible for warranty service.
5. Write the RMA number visibly on the outside of the package and ship it prepaid to your dealer.

Part No. 2006602812

Printed in China

Edition 3

December 2014

Declaration of Conformity

FCC Class A

Note: This equipment has been tested and found to comply with the limits for a Class A digital device, pursuant to part 15 of the FCC Rules. These limits are designed to provide reasonable protection against harmful interference when the equipment is operated in a commercial environment. This equipment generates, uses, and can radiate radio frequency energy and, if not installed and used in accordance with the instruction manual, may cause harmful interference to radio communications. Operation of this equipment in a residential area is likely to cause harmful interference in which case the user will be required to correct the interference at his own expense.

Caution! *There is a danger of a new battery exploding if it is incorrectly installed. Do not attempt to recharge, force open, or heat the battery. Replace the battery only with the same or equivalent type recommended by the manufacturer. Discard used batteries according to the manufacturer's instructions.*



A Message to the Customer

Advantech Customer Services

Each and every Advantech product is built to the most exacting specifications to ensure reliable performance in the harsh and demanding conditions typical of industrial environments. Whether your new Advantech equipment is destined for the laboratory or the factory floor, you can be assured that your product will provide the reliability and ease of operation for which the name Advantech has come to be known.

Your satisfaction is our primary concern. Here is a guide to Advantech's customer services. To ensure you get the full benefit of our services, please follow the instructions below carefully.

Technical Support

We want you to get the maximum performance from your products. So if you run into technical difficulties, we are here to help. For the most frequently asked questions, you can easily find answers in your product documentation. These answers are normally a lot more detailed than the ones we can give over the phone.

So please consult this manual first. If you still cannot find the answer, gather all the information or questions that apply to your problem, and with the product close at hand, call your dealer. Our dealers are well trained and ready to give you the support you need to get the most from your Advantech products. In fact, most problems reported are minor and are able to be easily solved over the phone.

In addition, free technical support is available from Advantech engineers every business day. We are always ready to give advice on application requirements or specific information on the installation and operation of any of our products.

Memory Compatibility

PCA-6028 Compatible Memory

Brand	Size	Speed	Type	ECC	Vendor PN	Memory	Advantech PN
Apacer	1GB	DDR3 1066	DDR3	N	78.01GC3.420	ELPIDA J1108BDBG-DJ-F (128x8)	96D3-1G1066NN-AP
	2GB	DDR3 1066	DDR3	N	78.A1GC3.421	ELPIDA J1108BDBG-DJ-F (128x8)	96D3-2G1066NN-AP
	4GB	DDR3 1066	DDR3	N	78.B1GDJ.AF1	HYNIX H5TQ2G83BFR-H9C	NA
	1GB	DDR3 1333	DDR3	N	78.01GC6.AF0	H5TQ1G83DFR-H9C H5TQ1G83TFR-H9C	96D3-1G1333NN-AP1
	2GB	DDR3 1333	DDR3	N	78.A1GDE.4200C	ELPIDA J2108BCSE-DJ-F	96D3-2G1333NN-AP2
	2GB	DDR3 1333	DDR3	N	78.A1GDE.AF00C	Hynix H5TQ2G838FR(256x8)	96D3-2G1333NN-AP1
	4GB	DDR3 1333	DDR3	N	78.B1GDE.AF1	HYNIX H5TQ2G83BFR-H9C	96D3-4G1333NN-AP
	4GB	DDR3 1333	DDR3	N	78.B1GDE.AF1	HYNIX H5TQ2G83BFR H9C 256x8	96D3-4G1333NN-AP
	8GB	DDR3 1333	DDR3	N	78.C1GEP.4210C	ELPIDA J4208BASE-DJ-F 512x8	78.C1GEP.4210C
	8GB	DDR3 1600	DDR3	N	78.C1GET.ATF0C	Micron 2FD27 D9PCP (512x8)	NA
Transcend	1GB	DDR3 1066	DDR3	N	TS128MLK64V1U	SEC K4B1G0846G-BCH9	96D3-1G1066NN-TR
	2GB	DDR3 1066	DDR3	N	TS256MLK64V1U	SEC K4B1G0846G-BCH9	96D3-2G1066NN-TR
	1GB	DDR3 1333	DDR3	N	TS128MLK64V3U	ELPIDA EDJ1108BFBG-DJ-F	96D3-1G1333NN-TR
	2GB	DDR3 1333	DDR3	N	TS256MLK64V3U	SEC K4B1G0846G-BCH9	96D3-2G1333NN-TR4
	4GB	DDR3 1333	DDR3	N	TS512MLK64V3N	HYNIX H5TQ2G83CFR H9C 256x8	96D34G1333NN-TR
	2GB	DDR3 1600	DDR3	N	TS256MLK64V6N	MICRON IRM72 D9PFJ	NA
	4GB	DDR3 1600	DDR3	N	TS512MLK64V6N	MICRON IUM22 D9PFJ	NA
	4GB	DDR3 1600	DDR3	N	TS512MLK64V6N	MICRON 2EM77 D9PFJ 256x8	NA
	8GB	DDR3 1600	DDR3	N	TS1GLK64V6H	micron IZD27 D9PBC 512x8	NA
Kingston	2GB	DDR3 1333	DDR3	N	KVR1333D3S8N9/2G	ELPIDA J2108BCSE-DJ-F(128x8)	NA
	4GB	DDR3 1333	DDR3	N	KVR1333D3N9/4G	KINGSTON D2568JENC PGD9U(512x64)	NA
ATP	2GB	DDR3 1600	DDR3	N	XQ16A8N2GS-9-AV	SEC K4B2G0846D (256x8)	NA
	2GB	DDR3 1600	DDR3	N	XQ16A8N2GM-9-AV	MICRON 2HM77 D9PFJ (256x8)	NA
	4GB	DDR3 1600	DDR3	N	XQ16B8N4GS-9-AV	SEC K4B2G0846D (256x8)	NA
	8GB	DDR3 1600	DDR3	N	XQ16B8N8GS-9-AV	SEC K4B4G0846B (512x8)	NA
DSL	2GB	DDR3 1600	DDR3	N	D3US56081XH12AA	SEC 113 HCK0 K4B2G0846C 256x8	NA
	4GB	DDR3 1600	DDR3	N	D3US56082XH12AA	SEC 113 HCK0 K4B2G0846C 256x8	NA
ADVANTECH	8GB	DDR3L 1600	DDR3	N	TS9JNH28303-6S	SEC 316 XYK0 K4B4G0846B	NA

Specification Comparison

Part Number	LAN	VGA	DVI-D	COM	SATA	USB	m-SATA
PCA-6028VG-00A1E	1	Yes	-	2	3 (1 x 2.0 + 2 x 3.0)	9 (2 x 3.0 + 7 x 2.0)	1
PCA-6028G2-00A1E	2	Yes	1*	2	3 (1 x 2.0 + 2 x 3.0)	10 (2 x 3.0 + 8 x 2.0)	1

Note! Output DVI-D signal only (Required DVI-D cable: 1700021831-01)



Processor Support

Model	Architecture		Advantech P/N	CPU Processor Socket LGA1150	Base Freq. (GHz)	L3 cache	Cores/Treads	TDP	DDR3 memory speed support	ECC	AMT
	Processor Gen	Process									
PCA-6028	Haswell	22nm	TBC	Core i7-4790S	3.2GHz	8MB	4/8	65W	1600	N/A	N/A
			96MPI7-3.1-8M10T	Core i7-4770S	3.1GHz	8MB	4/8	65W			
			96MPI7-2.3-8M10T	Core i7-4770TE	2.3GHz	8MB	4/8	45W			
			TBC	Core i5-4590S	3.0GHz	6MB	4/4	65W			
			TBC	Core i5-4590T	2.0GHz	6MB	4/4	35W			
			96MPI5-2.9-6M10T	Core i5-4570S	2.9GHz	6MB	4/4	65W			
			96MPI5-2.7-4M10T	Core i5-4570TE	2.7GHz	4MB	2/4	35W			
			TBC	Core i3-4360	3.7GHz	4MB	2/4	54W			
			TBC	Core i3-4350T	3.1GHz	4MB	2/4	35W			
			TBC	Core i3-4340TE	2.8GHz	4MB	2/4	35W			
			96MPI3-3.5-4M10T	Core i3-4330	3.5GHz	4MB	2/4	54W			
			TBC	Core i3-4330TE	2.4GHz	3MB	2/4	35W			
			TBC	Pentium G3420	3.2GHz	3MB	2/2	54W			
			96MPP-2.3-3M10T	Pentium G3320TE	2.3GHz	3MB	2/2	35W			

Initial Inspection

Before you begin installing your motherboard, please make sure that the following materials have been shipped:

- 1 PCA-6028 PICMGG 1.0 Single Host Board
- 1 PCA-6028 startup manual
- 2 Serial ATA HDD data cable P/N: 1700003194
- 1 Serial ATA HDD power cable P/N: 1700022749-11
- 1 COM + printer ports cable kit P/N: 1701260305
- 1 4-port USB cable kit P/N: 1700008461-11
- Keyboard and mouse Y cable P/N: 1700060202
- 1 jumper package P/N: 9689000068

If any of these items are missing or damaged, contact your distributor or sales representative immediately. We have carefully inspected the PCA-6028 mechanically and electrically before shipment. It should be free of marks and scratches and in perfect working order upon receipt. As you unpack the PCA-6028, check it for signs of shipping damage. (For example, damaged box, scratches, dents, etc.) If it is damaged or it fails to meet the specifications, notify our service department or your local sales representative immediately. Also notify the carrier. Retain the shipping carton and packing material for inspection by the carrier. After inspection, we will make arrangements to repair or replace the unit.

Contents

Chapter 1 Hardware Configuration1

1.1	Introduction	2
1.2	Features & Benefits.....	2
1.3	Specifications	3
1.3.1	System	3
1.3.2	Memory	3
1.3.3	Input/Output	3
1.3.4	Graphics.....	4
1.3.5	Ethernet LAN	4
1.3.6	Industrial features	4
1.3.7	Mechanical and environmental specifications.....	4
1.4	Jumpers and Connectors	5
	Table 1.1: Jumper list	5
	Table 1.2: Connectors	5
1.5	Board Layout: Jumper and Connector Locations.....	6
	Figure 1.1 Jumper and connector locations.....	6
1.6	Block Diagram.....	7
	Figure 1.2 PCA-6028 Block Diagram.....	7
1.7	Safety Precautions	8
1.8	Jumper Settings	8
1.8.1	How to set jumpers	8
1.8.2	BIOS CMOS (JCMOS1).....	9
	Table 1.3: JCMOS1/JME1: clear CMOS/ME data.....	9
1.8.3	Watchdog timer output (JWDT1)	9
	Table 1.4: Watchdog timer output (JWDT1).....	9
	Table 1.5: H/W monitor alarm (JOBS1).....	9
	Table 1.6: JERP1: Deep Sleep S5	9
1.9	System Memory	10
1.10	Memory Installation Procedures.....	10
1.11	Cache Memory.....	10
1.12	Processor Installation.....	10
1.13	Processor Cooler Installation	12

Chapter 2 Connecting Peripherals13

2.1	Introduction	14
2.2	Parallel Port (LPT1).....	14
2.3	USB Ports (USB01,USB23,USB45,USB8,USB9,USB1011).....	14
2.4	VGA Connectors (VGA1)	15
2.5	Serial Ports (COM1 & COM2).....	15
2.6	PS/2 Keyboard and Mouse Connector (KBMS1/KBMS2).....	16
2.7	CPU Fan Connector (CPUFAN1).....	16
2.8	Front Panel Connectors (JFP1, JFP2 & JFP3)	17
2.8.1	Power LED and keyboard lock (JFP3).....	17
	Table 2.1: PS/2 or ATX power supply LED status.....	17
2.8.2	External speaker (JFP2)	17
2.8.3	Reset connector (JFP1).....	18
2.8.4	HDD LED connector (JFP2).....	18
2.8.5	ATX soft power switch (JFP1).....	18
2.9	H/W Monitor/Watchdog Timer/Infrared	19
2.9.1	H/W monitor alarm (JOBS1)	19
2.9.2	Watchdog timer (JWDT1)	19
2.9.3	Infrared interface (JIR1).....	19
2.10	LAN Ports (LAN1 & LAN2).....	20

	Table 2.2: LAN LED Indicators	20
2.11	High Definition Audio Module Interface (HDAUD1)	21
	Figure 2.1 Jumper and connector locations of PCA-AUDIO-HDA1E	22
2.12	GPIO Header (GPIO1).....	23
2.13	Case Open Connector (JCASE1)	23
2.14	Front Panel LAN Indicator Connector (LANLED1).....	24
	Table 2.3: LAN LED Indicators	24
2.15	Serial ATA Interface (SATA1~SATA3).....	25
2.16	mSATA Connector (MINIPCIE1).....	25
2.17	LPC Extension Interface (LPC1).....	26

Chapter 3 AMI BIOS Setup..... 27

3.1	Introduction	28
	Figure 3.1 Setup program initial screen.....	28
3.2	Entering Setup	29
3.2.1	Main Setup.....	29
	Figure 3.2 Main setup screen	29
3.2.2	Advanced BIOS Features Setup.....	30
	Figure 3.3 Advanced BIOS features setup screen	30
	Figure 3.4 PCI Subsystem Settings.....	31
	Figure 3.5 ACPI Settings	32
	Figure 3.6 Trust Computing.....	33
	Figure 3.7 S5 RTC configuration	34
	Figure 3.8 CPU Configuration	35
	Figure 3.9 SATA Configuration.....	36
	Figure 3.10Firmware Update Configuration	38
	Figure 3.11USB Configuration.....	39
	Figure 3.12Smart Setting.....	40
	Figure 3.13Super IO Configuration.....	41
	Figure 3.14Serial Port 1 Configuration	41
	Figure 3.15Serial Port 2 Configuration	42
	Figure 3.16Parallel Configuration	42
	Figure 3.17PC Health Status.....	43
3.2.3	Chipset.....	44
	Figure 3.18Chipset	44
	Figure 3.19PCH IO Configuration.....	45
	Figure 3.20USB Configuration.....	46
	Figure 3.21PCH Azalia Configuration.....	47
	Figure 3.22Graphics Configuration.....	48
	Figure 3.23Memory Information	49
3.2.4	Boot	50
	Figure 3.24 Boot	50
3.2.5	Security.....	52
	Figure 3.25Security	52
3.2.6	Save & Exit	53
	Figure 3.26Save & Exit.....	53

Chapter 4 Value-Added Software Services 55

4.1	Value-Added Software Services	56
4.1.1	Software API.....	56
4.1.2	Software Utility.....	56

Chapter 5 Chipset Software Installation Utility 57

5.1	Before You Begin.....	58
-----	-----------------------	----

5.2	Introduction	58
5.3	Windows® 7 / Windows® 8 Driver Setup	59
Chapter 6	Integrated Graphic Device Setup	61
6.1	Introduction	62
6.2	Windows 7/ Windows 8 Driver Setup	62
Chapter 7	LAN Configuration.....	63
7.1	Introduction	64
7.2	Installation	64
7.3	Win XP /Win 7 Driver Setup (LAN).....	64
Chapter 8	Intel ME	65
8.1	Introduction	66
8.2	Installation	66
Chapter 9	Intel USB 3.0	67
9.1	Introduction	68
9.2	Installation	68
Appendix A	Programming the Watchdog Timer..	69
A.1	Introduction	70
A.1.1	Watchdog timer overview.....	70
A.1.2	Programming the watchdog timer	70
	Table A.1: Watchdog timer registers.....	71
A.1.3	Example program.....	72
Appendix B	I/O Pin Assignments.....	77
B.1	Parallel Port Connector (LPT1).....	78
	Table B.1: Parallel port connector (LPT1).....	78
B.2	VGA Connector (VGA1).....	78
	Table B.2: VGA connector (VGA1)	78
B.3	RS 232 Serial Port (COM12).....	79
	Table B.3: RS-232 serial port (COM2).....	79
B.4	USB 2.0 Header (USB56 & 910).....	79
	Table B.4: USB Header (USB56 & 910)	79
B.5	USB3.0 Header (USB12)	80
	Table B.5: USB 3.0 Header (USB12).....	80
B.6	PS/2 Keyboard/Mouse Connector (KBMS1)	80
	Table B.6: PS/2 keyboard/mouse connector (KBMS1).....	80
B.7	External Keyboard Connector (KBMS2)	81
	Table B.7: External keyboard connector (KBMS2)	81
B.8	CPU Fan Power Connector (CPUFAN1)	81
	Table B.8: CPU fan power connector (CPUFAN1)	81
B.9	Power LED and Keyboard Lock Connector (JFP3 / PWR_LED & KEY LOCK)	81
	Table B.9: Power LED and keyboard lock connector (JFP3 / PWR_LED & KEY LOCK).....	81
B.10	External Speaker Connector (JFP2 / SPEAKER)	82

	Table B.10:External speaker connector (JFP2 / SPEAKER).....	82
B.11	Reset Connector (JFP1 / RESET)	82
	Table B.11:Reset connector (JFP1 / RESET)	82
B.12	HDD LED (JFP2 / HDDLED).....	82
	Table B.12:HDD LED (JFP2 / HDDLED)	82
B.13	ATX Soft Power Switch (JFP1 / PWR_SW).....	83
	Table B.13:ATX soft power switch (JFP1 / PWR_SW).....	83
B.14	Hi-definition Audio Link Connector (HDAUD1)	83
	Table B.14:Hi-definition audio link connector (HDAUD1)	83
B.15	SM Bus Connector (JFP2 / SNMP).....	83
	Table B.15:SM bus connector (JFP2 / SNMP)	83
B.16	LAN1 and LAN2 LED Connector (LANLED1)	84
	Table B.16:LAN1 and LAN2 LED connector (LANLED1)	84
B.17	GPIO Header (GPIO1).....	84
	Table B.17:GPIO header (GPIO1).....	84
B.18	Fixed I/O Ranges Decoded by Intel PCH	85
	Table B.18:Fixed I/O Ranges Decoded by PCH.....	85
B.19	System I/O Ports.....	86
	Table B.19:System I/O Ports	86
B.20	Interrupt Assignments	87
	Table B.20:Interrupt Assignments	87
B.21	1 MB Memory Map.....	87
	Table B.21:1 MB memory map	87
B.22	PCI Bus Map.....	87
	Table B.22:PCI Bus Map	87

Appendix C Programming the GPIO 89

C.1	Supported GPIO Register	90
C.2	GPIO Registers.....	90
C.3	GPIO Example Program-1	90

Chapter 1

Hardware
Configuration

1.1 Introduction

PCA-6028 is a PICMG 1.0 form-factor single host board which is designed with Intel® H81 PCH for industrial applications that need high computing power and strong I/O capability. PCA-6028 supports 22nm manufacturing technology, LGA1150 socket Intel® Core™ i7/i5/i3 and Pentium® processors that integrate memory and graphic controllers and support DDR3 1333/1600 MHz SDRAM up to 16 GB. By supporting advanced computing technology, PCA-6028 is suitable for computing power hungry industrial applications.

PCA-6028 performs excellent graphic processing capability with its processor integrated Intel® HD Graphics core with shared memory around 1 GB when installed 2GB and above system memory. With this feature, PCA-6028 provides strong 2D/3D graphic processing power without a discrete graphic card to save extra cost, power consumption and thermal design effort.

PCA-6028 also has rich I/O interfaces, and it can support Advantech PICMG 1.0 compatible backplanes to offer various expansion slots such as PCI and ISA slots.

New SATA Gen3 (600MB/sec) ports meet high data transfer performance applications, like storage and DVR. Three SATA ports, two USB 3.0 ports reach 5Gbps high data transfer application, the two on-board RS-232 serial ports are for COM ports based industrial control applications. With flexible I/O and graphic expansibility, PCA-6028 is an excellent, cost effective graphic or I/O oriented workstation class hardware platform. With outstanding performance and exceptional features, PCA-6028 is the ideal computing platform for advanced industrial applications.

1.2 Features & Benefits

Features	Benefits
PCA-6028 supports Intel 4th generation processors	Intel's Haswell Core i7/i5/i3/Pentium processor cores with quad/dual-core computing power brings quantum-leap performance improvement.
PCA-6028 supports DDR3 1333/1600 SDRAM up to 16 GB	Provides higher memory data transmission and processing efficiency, bringing higher system performance.
Fully supports Advantech SUSI APIs and Utilities.	Reduces customer S/W development effort with more reliable S/W quality, also provides value-added utilities such as system monitor and Embedded Security ID.
SATA Gen3	Provides high performance storage interface. SATA Gen3 is 6Gb/s which is double bandwidth with SATA Gen2.
USB 3.0	Provides high transfer data performance interface; USB 3.0 data transfer rate is 5Gbps which is 10 times faster than USB2.0.

1.3 Specifications

1.3.1 System

- **CPU:** LGA1150-socket Core i7/i5/i3 and Pentium series processors
- **L3 Cache:** Please refer to CPU specification for detail information.
- **BIOS:** AMI SPI BIOS (128 Mb SPI)
- **System Chipset:** Intel H81
- **SATA hard disk drive interface:** Two SATA3 (600MB/s) with blue connectors and one SATA2 (300MB/s) with black connectors. These interfaces can be enabled/disabled in the BIOS.

Note! PCA-6028 does NOT support PATA(IDE) interface.



1.3.2 Memory

- **RAM:**
 - PCA-6028: Up to 16 GB in two 240-pin DIMM sockets. Supports dual-channel DDR3 1333/1600 MHz SDRAM WITHOUT ECC function.

Note! 1. Due to the inherent limitations of PC architecture, the system may not fully detect 16 GB RAM when 16 GB RAM is installed.



2. A 32-bit OS may not fully detect 4 GB of RAM when 4 GB is installed.

1.3.3 Input/Output

- **ISA bus:** HISA (ISA high driver)
- **PCI bus:** Four PCI masters to the backplane, 32-bit, 33 MHz PCI 2.2 compliant.
- **Enhanced parallel port:** This EPP/SPP/ECP port can be configured to LPT1, LPT2, LPT3 or disabled. A standard DB-25 female connector provided.
- **Serial ports:** Two RS-232 serial ports
- **PS/2 keyboard and mouse connector:** One 6-pin mini-DIN connectors is located on the mounting bracket for easy connection to a PS/2 keyboard and mouse via the Y-cable included in the package.
- **USB port:** Supports 9 USB 2.0 ports with transfer rate up to 480 Mbps. (5 ports are on the CPU card and 4 ports are on the backplane), and 3 USB 3.0 ports with transfer rate up to 5 Gbps.
- **LPC:** One LPC connector to support Advantech TPM LPC modules.
- **GPIO:** Supports 8-bit GPIO from super I/O for general purpose control application.

1.3.4 Graphics

- **Controller:** Intel® HD Graphics embedded in the processor.
- **Display memory:** Shared memory is subject to OS (Please install 2 GB or above memory for basic system configuration).
- **CRT:** Up to 2048 x 1536 resolution, 400 MHz RAMDAC.
- **DVI-D:** One DVI-D pin header supports resolution up to 1920 x 1200 @ 60 Hz.
- **PCI slot on the backplane:** An external graphic card can be installed on PCI slots for stronger 2D/3D graphic capability.

1.3.5 Ethernet LAN

- Supporting single/dual 10/100/1000 Mbps Ethernet port(s) via the dedicated PCI Express x1 bus which provides 500 MB/s data transmission rate.
- **Controller:**
 - LAN 1: Intel® I217V.
 - LAN 2: Intel® I211 for G2 sku only.

1.3.6 Industrial features

- **Watchdog timer:** Can generate a system reset. The watchdog timer is programmable, with each unit equal to one second (255 levels).

1.3.7 Mechanical and environmental specifications

- **Operating temperature:** 0 ~ 60° C (32 ~ 140° F, depending on CPU and thermal solution)
- **Storage temperature:** -40 ~ 85° C (-40 ~ 185° F)
- **Humidity:** 20 ~ 95% non-condensing
- **Power supply voltage:** +5 V, +12 V, +5 VSB
- **Power consumption:**
Test Environment: Core i7-4790S@3.20GHz; 8GB DDR3 1600 2Rx8*2; SATA HDD*1
Voltage +12V +5V +3.3V +5Vsb -12V -5V
Current 4.94A 1.83A 0A 0.01A 0A 0A
- **Board size:** 338.58 mm (L) x 126.39 mm (W) (13.3" x 4.98")
- **Board weight:** 0.5 kg

1.4 Jumpers and Connectors

Connectors on the PCA-6028 single host board link it to external devices such as hard disk drives and a keyboard. In addition, the board has a number of jumpers used to configure your system for your application.

The tables below list the function of each of the board jumpers and connectors. Later sections in this chapter give instructions on setting jumpers. Chapter 2 gives instructions for connecting external devices to your motherboard.

Table 1.1: Jumper list

Label	Function
JCMOS1	CMOS clear
JME1	Clear ME data
JWDT1	Watchdog timer output selection
JOBS1	HW Monitor Alarm

Table 1.2: Connectors

Label	Function
LPT1	Parallel port, Parallel port x 1, supports SPP/EPP/ECP mode
LAN1	Intel I217V
LAN2	Intel I211 (G2 sku only)
VGA1	VGA connector
KBMS1	PS/2 keyboard and mouse connector
KBMS2	External keyboard/mouse connector
COM1	Serial port: COM1; RS-232 (9-pin Box Header)
COM2	Serial port: COM2; RS-232 (9-pin Box Header)
JIR	Infrared connector
JFP3 (Keyboard Lock and Power LED)	Power LED
	Suspend: Fast flash (ATX/AT)
	System On: ON (ATX/AT)
	System Off: OFF ((ATX/AT))
JFP2	External speaker / SATA HDD LED connector
JFP1	Power Switch / Reset connector
JCASE1	Case Open
CPUFAN1	CPU FAN connector (4-pin)
LANLED1	LAN1/2 LED extension connector
HDAUD1	HD audio extension module connector
USB01	USB port 0,1 (3.0)
USB23	USB port 2,3
USB45	USB port 4,5
USB8	USB port 8 (G2 sku only)
USB9	USB port 9
USB1011	USB port 10,11
SATA1	Serial ATA1 (3.0)
SATA2	Serial ATA2 (3.0)
SATA3	Serial ATA3
CPU1	CPU Socket
DIMMA1	Memory connector channel A

DIMMB1	Memory connector channel B
GPIO1	GPIO pin header (SMD pitch-2.0 mm)
LPC1	COM port module expansion pin-header
DVI1	DVI connector
MINIPCIE1	mSATA connector
SMBUS1	SMBus connector
ATX12V1	12V connector
ATXF1	ATX power connector

1.5 Board Layout: Jumper and Connector Locations

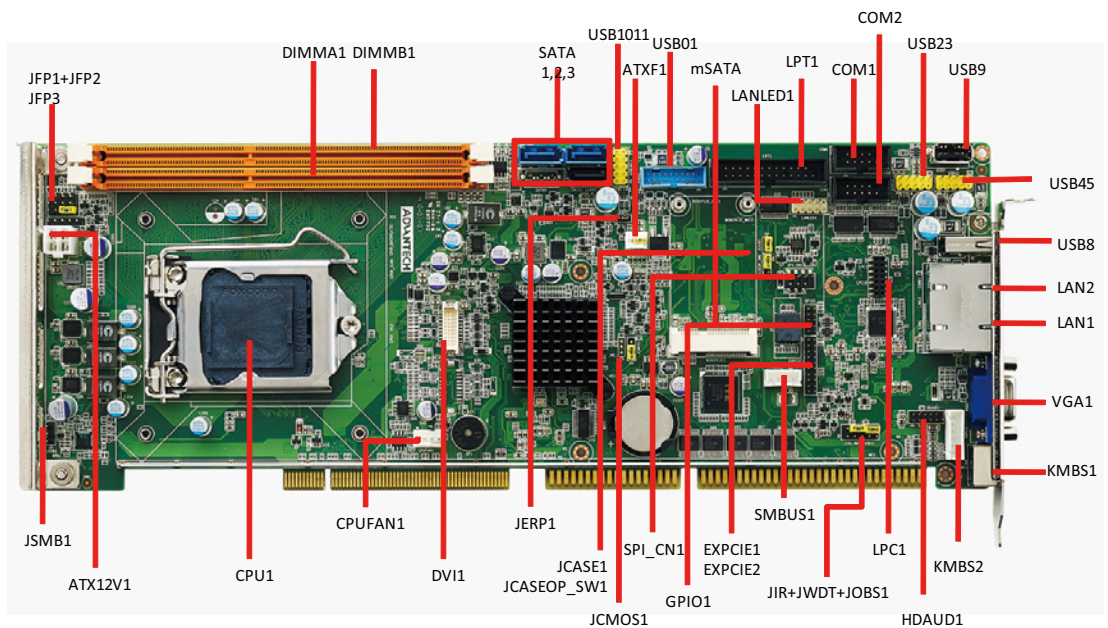

Figure 1.1 Jumper and connector locations

1.6 Block Diagram

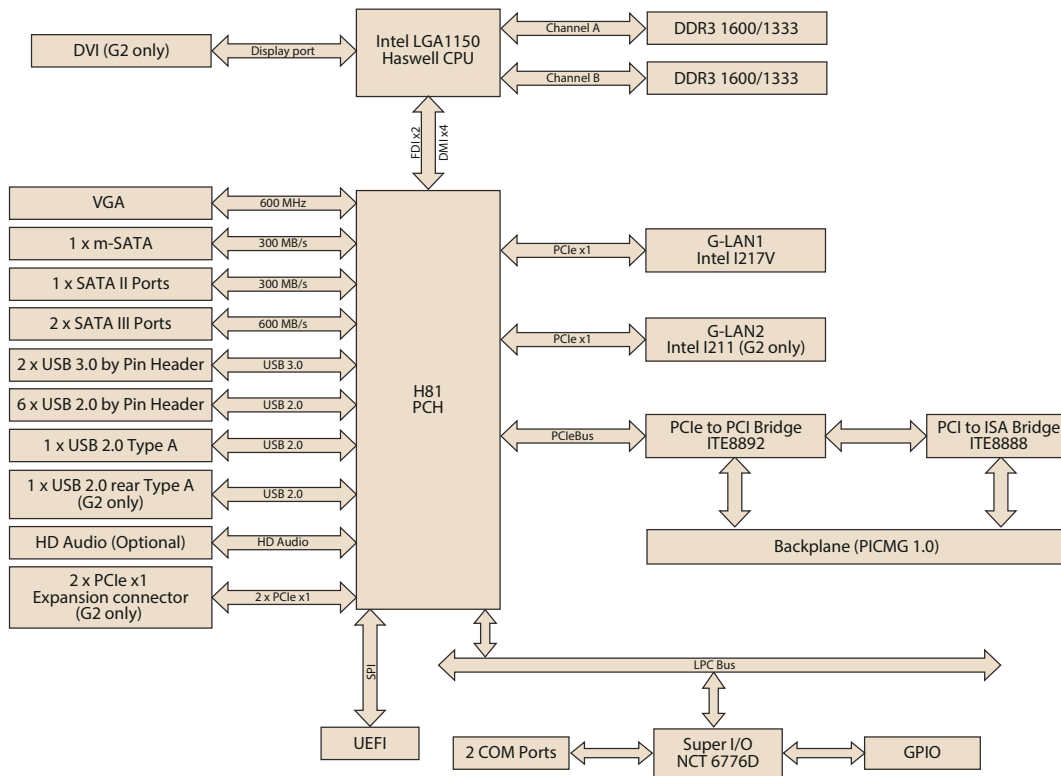

Figure 1.2 PCA-6028 Block Diagram

1.7 Safety Precautions

Warning! Always completely disconnect the power cord from your chassis whenever you work with the hardware. Do not make connections while the power is on. Sensitive electronic components can be damaged by sudden power surges. Only experienced electronics personnel should open the PC chassis.



Caution! Always ground yourself to remove any static charge before touching the motherboard. Modern electronic devices are very sensitive to static electrical discharges. As a safety precaution, use a grounding wrist strap at all times. Place all electronic components on a static-dissipative surface or in a static-shielded bag when they are not in the chassis.



Caution! The computer is provided with a battery-powered Real-time Clock. There is a danger of explosion if battery is incorrectly replaced. Replace only with same or equivalent type recommended by the manufacturer. Discard used batteries according to manufacturer's instructions.



Caution! There is a danger of a new battery exploding if it is incorrectly installed. Do not attempt to recharge, force open or heat the battery. Replace the battery only with the same or equivalent type recommended by the manufacturer. Discard used batteries according to the manufacturer's instructions.



1.8 Jumper Settings

This section provides instructions on how to configure your motherboard by setting the jumpers. It also includes the motherboard's default settings and your options for each jumper.



1.8.1 How to set jumpers

You can configure your motherboard to match the needs of your application by setting the jumpers. A jumper is a metal bridge that closes an electrical circuit. It consists of two metal pins and a small metal clip (often protected by a plastic cover) that slides over the pins to connect them. To “close” (or turn ON) a jumper, you connect the pins with the clip. To “open” (or turn OFF) a jumper, you remove the clip. Sometimes a jumper consists of a set of three pins, labeled 1, 2 and 3. In this case you connect either pins 1 and 2, or 2 and 3. A pair of needle-nose pliers may be useful when setting jumpers.

1.8.2 BIOS CMOS (JCMOS1)

The PCA-6028 CPU card contains a jumper that can erase BIOS CMOS/ME data and reset the system BIOS information. Normally this jumper should be set with pins 1-2 closed. If you want to reset those data, set JCMOS1/JME1 to 2-3 closed for just a few seconds, and then move the jumper back to 1-2 closed. This procedure will reset the CMOS/ME to its last status or default setting.

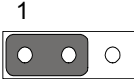
Table 1.3: JCMOS1/JME1: clear CMOS/ME data

Function	Jumper Setting
*Keep BIOS CMOS/ME data	 1-2 closed
Clear BIOS CMOS/ME data	 2-3 closed

* default setting

1.8.3 Watchdog timer output (JWDT1)

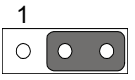
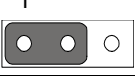

The PCA-6028 contains a watchdog timer that will reset the CPU in the event the CPU stops processing. This feature means the PCA-6028 will recover from a software failure or an EMI problem. The JWDT1 jumper settings control what the computer will do in the event the watchdog timer is tripped.

Table 1.4: Watchdog timer output (JWDT1)

Function	Jumper Setting
* Reset	 2-3 closed
Reserved	 1-2 closed

*default setting

Table 1.5: H/W monitor alarm (JOBS1)

Function	Jumper Setting
Enabled	 1-2 closed
Disabled	 1-2 opened

(JOBS1) is a 2-pin connector for setting enable/disable alarm while the on-board security event acts.

Table 1.6: JERP1: Deep Sleep S5

Close Pins	Result
1-2	Enable
2-3	Disable (Default)

1.9 System Memory

PCA-6028 has two 240-pin memory sockets for (non-ECC) DDR3 1600 MHz memory modules with maximum capacity of 16 GB. (Maximum 8 GB for each DIMM)

Note! *PCA-6028 does NOT support registered DIMMs (RDIMMs).*



1.10 Memory Installation Procedures

To install DIMMs, first make sure the two handles of the DIMM socket are in the “open” position. i.e. the handles lean outward. Slowly slide the DIMM module along the plastic guides on both ends of the socket. Then press the DIMM module right down into the socket, until you hear a click. This is when the two handles have automatically locked the memory module into the correct position of the DIMM socket. To remove the memory module, just push both handles outward, and the memory module will be ejected by the mechanism in the socket.

1.11 Cache Memory

CPUs supported by PCA-6028 have 8 MB, 6 MB, 3 MB L3 cache memory sizes.

Note! *Please refer to Intel CPU data sheet for detail information.*



1.12 Processor Installation

Warning! *Without a fan or heat sink, the processor will overheat and cause damage to both the processor and the single board computer. To install a processor, first turn off your system.*



The PCA-6028 is designed for Intel® LGA 1150 socket processors.

1. Pull the bar beside the processor socket outward and lift it.

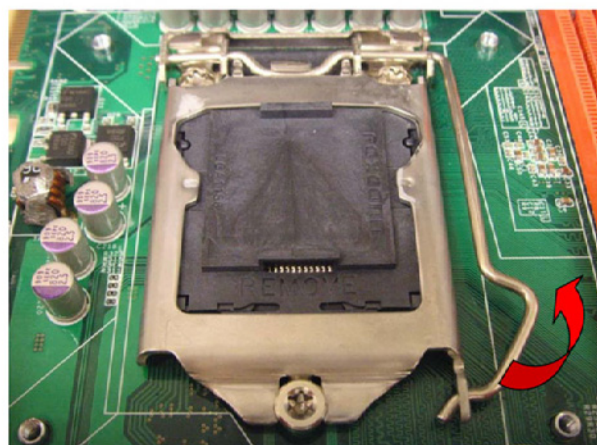

2. Remove the socket protection cap.

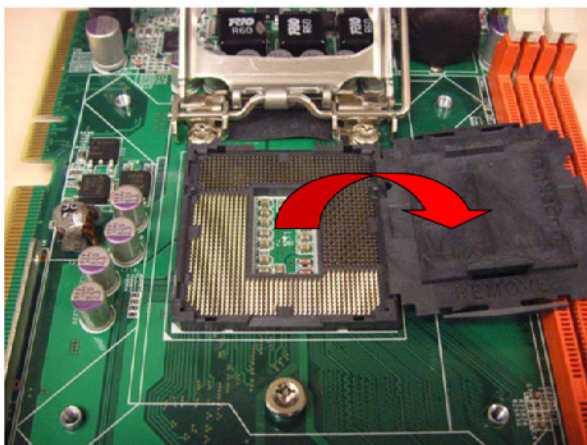

3. Align the cuts on the processor with the edges of the socket.

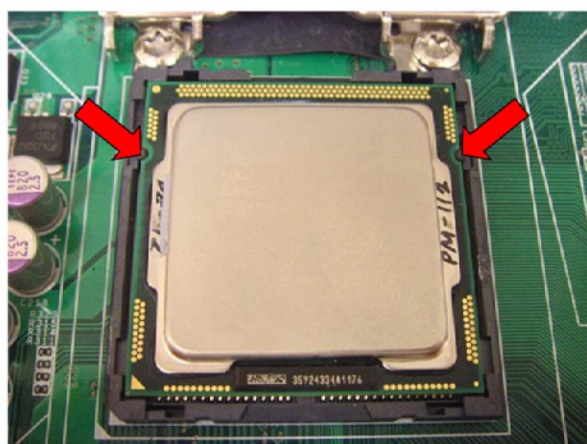

4. Replace the socket cap; lower the retainer bar and clip it shut.

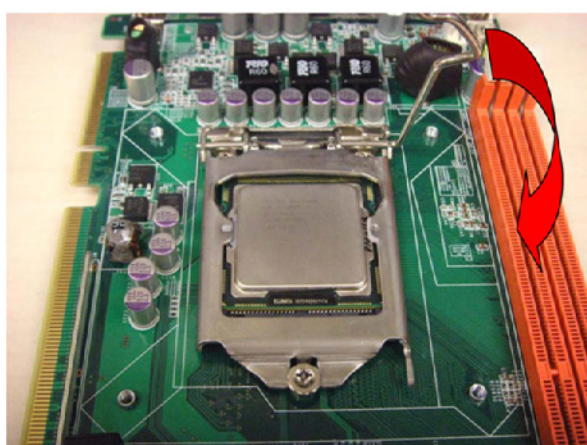

5. Finished processor installation.

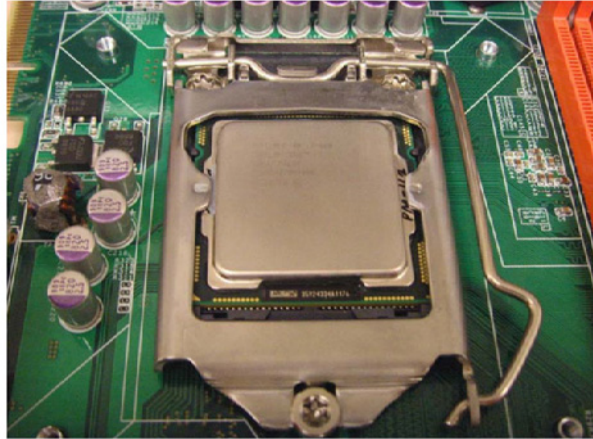

1.13 Processor Cooler Installation

Purchasing PCA-6028 optimized CPU cooler (P/N: 1960047831N001) from Advantech is a must. Other brand CPU coolers are NOT compatible with PCA-6028.

Advantech offers a specially designed CPU cooler for PCA-6028 for better heat dissipation efficiency and enhancing rigidity of CPU card, part number 1960047831N001. Buy it for PCA-6028 CPU card since it is NOT compatible with other brand CPU coolers (neither is it compatible with Intel boxed CPU cooler).

Please install 1960047831N001 CPU cooler following these instructions:

Attach the CPU cooler on CPU card by fastening four screws of the CPU cooler into the steel back-plate on PCB.



Note the direction of CPU cooler; it must follow that shown above. Installing a CPU cooler in the wrong direction may cause poor heat dissipation that may damage the CPU card.

Chapter 2

Connecting
Peripherals

2.1 Introduction

You can access most of the connectors from the top of the board. If you have a number of cards installed, you may need to partially remove the card to make all the connections.

2.2 Parallel Port (LPT1)

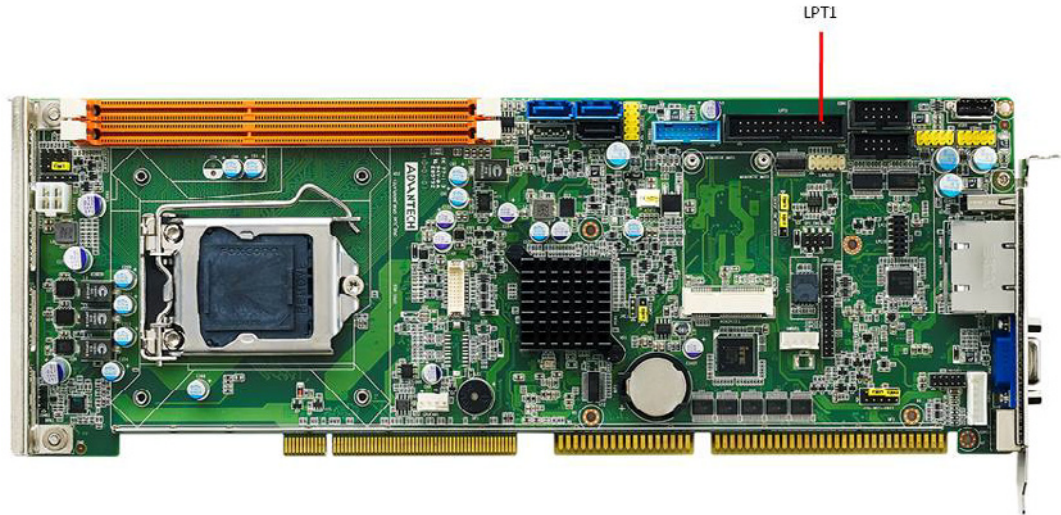

The parallel port is normally used to connect the motherboard to a printer. The PCA-6028 includes an onboard parallel port, accessed through a 26-pin flat-cable connector, LPT1.

2.3 USB Ports (USB01, USB23, USB45, USB8, USB9, USB10, 11)

The PCA-6028 provides up to 10 USB (Universal Serial Bus) on-board ports with complete Plug & Play and hot swap support for up to 127 external devices. These USB ports comply with USB Specification 2.0 and 3.0, support transfer rates up to 480 Mbps (USB2.0) and 5 Gbps (USB3.0). The USB interface can be disabled in the system BIOS setup.

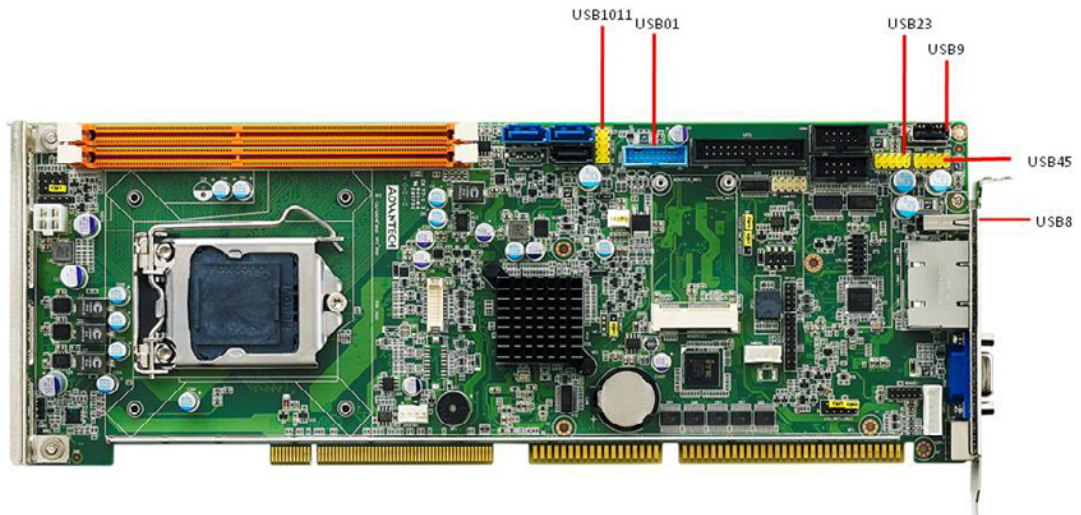

2.4 VGA Connectors (VGA1)

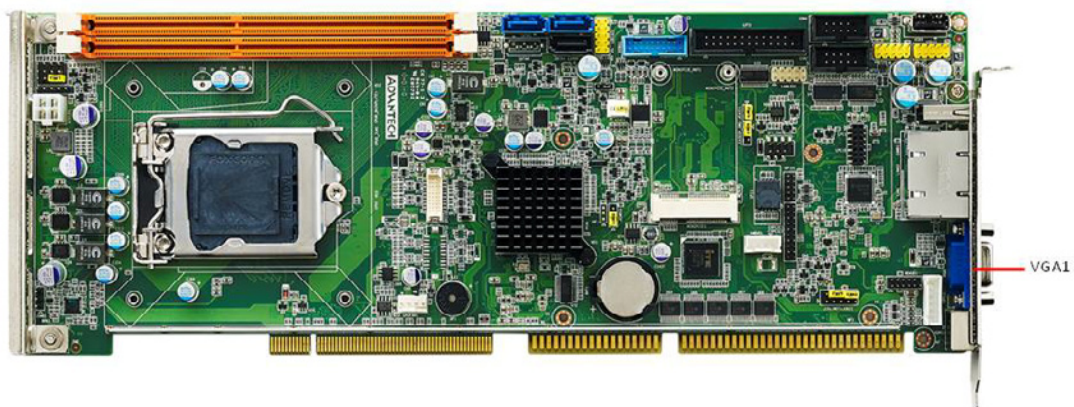

This CPU card has VGA outputs that can drive conventional CRT displays. VGA1 is a standard 15-pin D-SUB connector commonly used for VGA.

2.5 Serial Ports (COM1 & COM2)

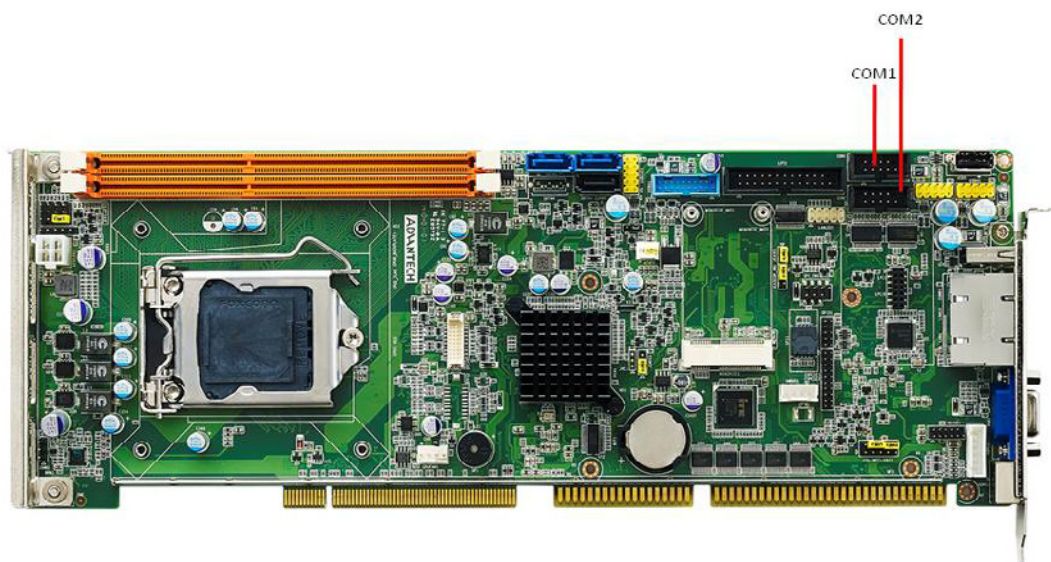

The PCA-6028 offers two serial ports. These ports can connect to serial devices, such as a mouse or a printer, or to a communications network.

The IRQ and address ranges for both ports are fixed. However, if you want to disable the port or change these parameters later, you can do this in the system BIOS setup. Optional dual COM cable, 1701092300, is available as well.

2.6 PS/2 Keyboard and Mouse Connector (KBMS1/KBMS2)

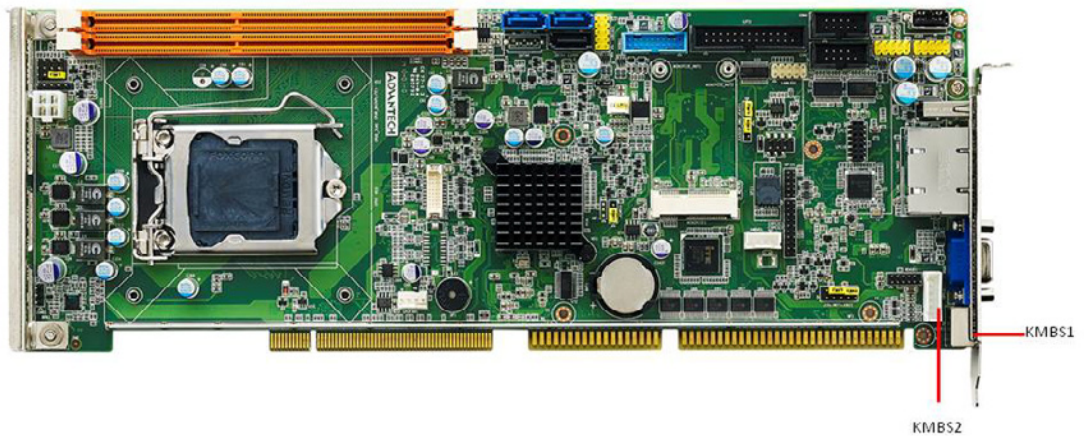

Two on-board 6-pin mini-DIN connectors (KBMS1) provide connection to PS/2 keyboard and mouse by the Y-cable (1700060202) in the package.

The on-board KBMS2 pin header provides connection to the front panel PS/2 keyboard and mouse connector of the chassis.

2.7 CPU Fan Connector (CPUFAN1)

This fan connector support 3-pin or 4-pin fan cooler and smart fan function.

Note! Fan speed is controlled by voltage.

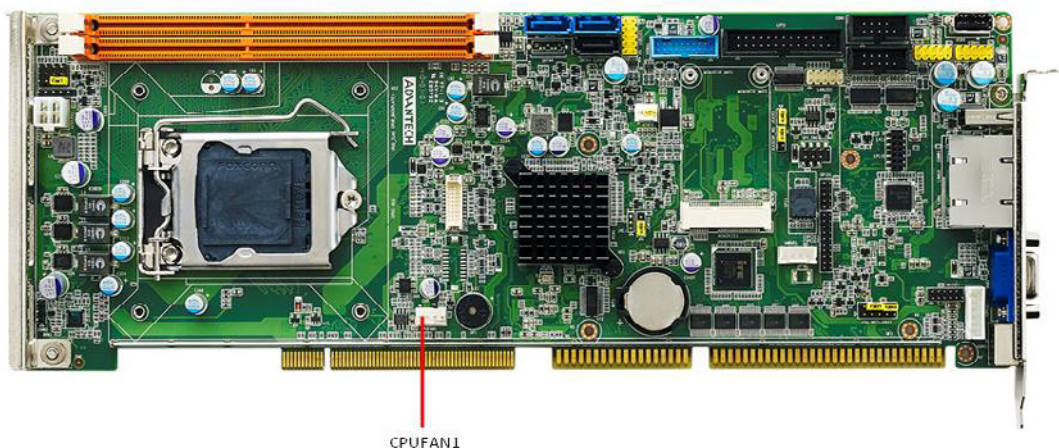

2.8 Front Panel Connectors (JFP1, JFP2 & JFP3)

There are several external switches to monitor and control the PCA-6028.

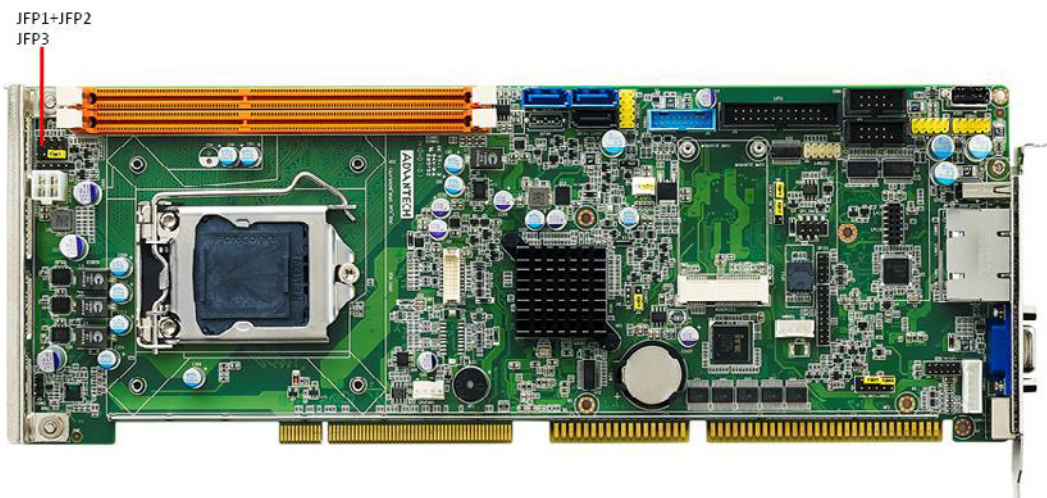

2.8.1 Power LED and keyboard lock (JFP3)

JFP3 is a 5-pin connector for the power LED. Refer to Appendix B for detailed information on the pin assignments. If a PS/2 or ATX power supply is used, the system's power LED status will be as indicated below:

Table 2.1: PS/2 or ATX power supply LED status

Power mode	LED (PS/2 power)	LED (ATX power)
System On	On	On
System Suspend	Flashes	Flashes
System Off	Off	Off

JFP1	PWR_SW	Reset
JFP2	HDD LED	SNMP
	Speaker	
JFP3	PWR_LED & Key Lock	

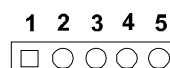

2.8.2 External speaker (JFP2)

JFP2 is a 4-pin connector for an external speaker. The PCA-6028 provides an onboard buzzer as an alternative to an external speaker. To enable the buzzer, set pins 3 and 4 as closed.

JFP1	PWR_SW	Reset
JFP2	HDD LED	SNMP
	Speaker	
JFP3	PWR_LED & Key Lock	

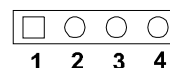

2.8.3 Reset connector (JFP1)

Many computer cases offer the convenience of a reset button. Connect the wire from the reset button.

JFP1	PWR_SW	Reset
JFP2	HDD LED	SNMP
	Speaker	
JFP3	PWR_LED & Key Lock	

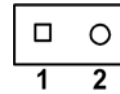

2.8.4 HDD LED connector (JFP2)

You can connect LED to connector JFP2 to indicate when the HDD is active.

JFP1	PWR_SW	Reset
JFP2	HDD LED	SNMP
	Speaker	
JFP3	PWR_LED & Key Lock	

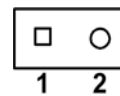

2.8.5 ATX soft power switch (JFP1)

If your computer case is equipped with an ATX power supply, you should connect the power on/off button on your computer case to JFP1. This connection enables you to turn your computer on and off.

JFP1	PWR_SW	Reset
JFP2	HDD LED	SNMP
	Speaker	
JFP3	PWR_LED & Key Lock	

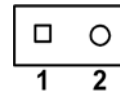

2.9 H/W Monitor/Watchdog Timer/Infrared

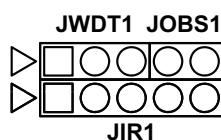
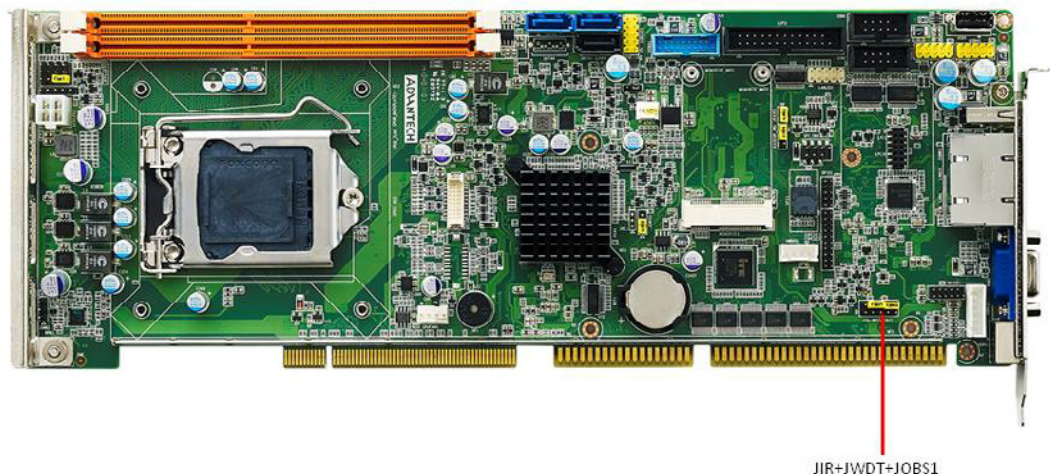

2.9.1 H/W monitor alarm (JOBS1)

This 2-pin header is for enabling/disabling H/W monitor alarm function.

Closed: Enables OBS Alarm

Open: Disables OBS Alarm

2.9.2 Watchdog timer (JWDT1)

This is for setting action trigger by watchdog timer.

1-2 Pin Close: No Action

2-3 Pin Close: System Reset

2.9.3 Infrared interface (JIR1)

This is a 5-pin header for an infrared device.

2.10 LAN Ports (LAN1 & LAN2)

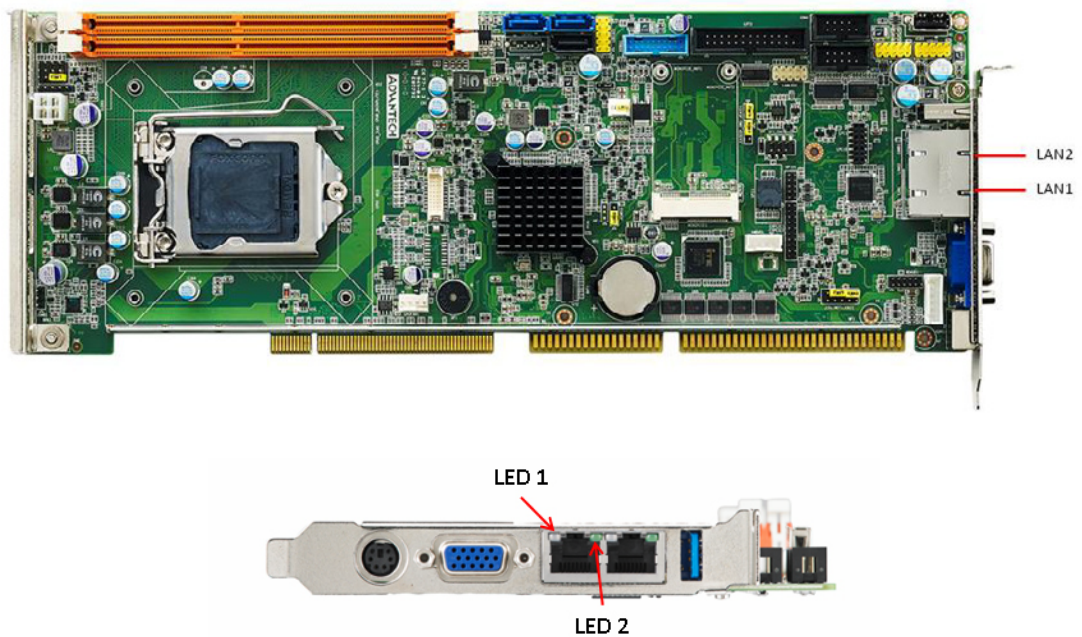

The PCA-6028 is equipped with one or two high-performance 1000 Mbps Ethernet LANs. They are supported by all major network operating systems. The RJ-45 jacks on the rear plate provides convenient connectivity.

Table 2.2: LAN LED Indicators

LAN Mode	LED1	LED2
1000Mbps Link On	Green On	On
1000Mbps Active	Green on	Flash
1000Mbps Link Off	Off	Off
100Mbps Link On	Orange On	On
100Mbps Active	Orange On	Flash
100Mbps Link Off	Off	Off
10Mbps Link On	Off	On
10Mbps Active	Off	Flash
10Mbps Link Off	Off	Off

2.11 High Definition Audio Module Interface (HDAUD1)

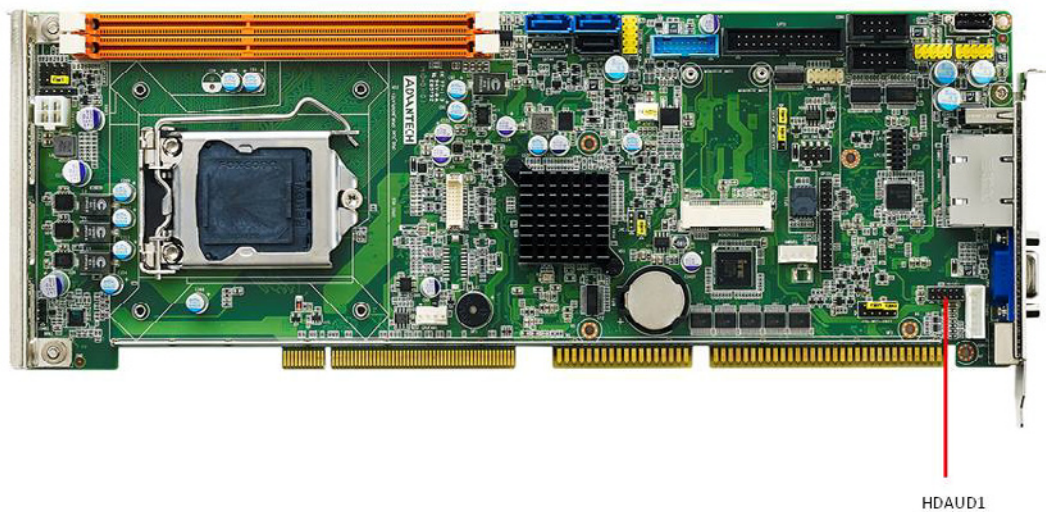

This HDAUD1 pin header is the connection interface to Advantech's 7.1 channel high definition audio module.

Note! Advantech 7.1 channel high definition audio module ordering information.



P/N: PCA-AUDIO-HDA1E

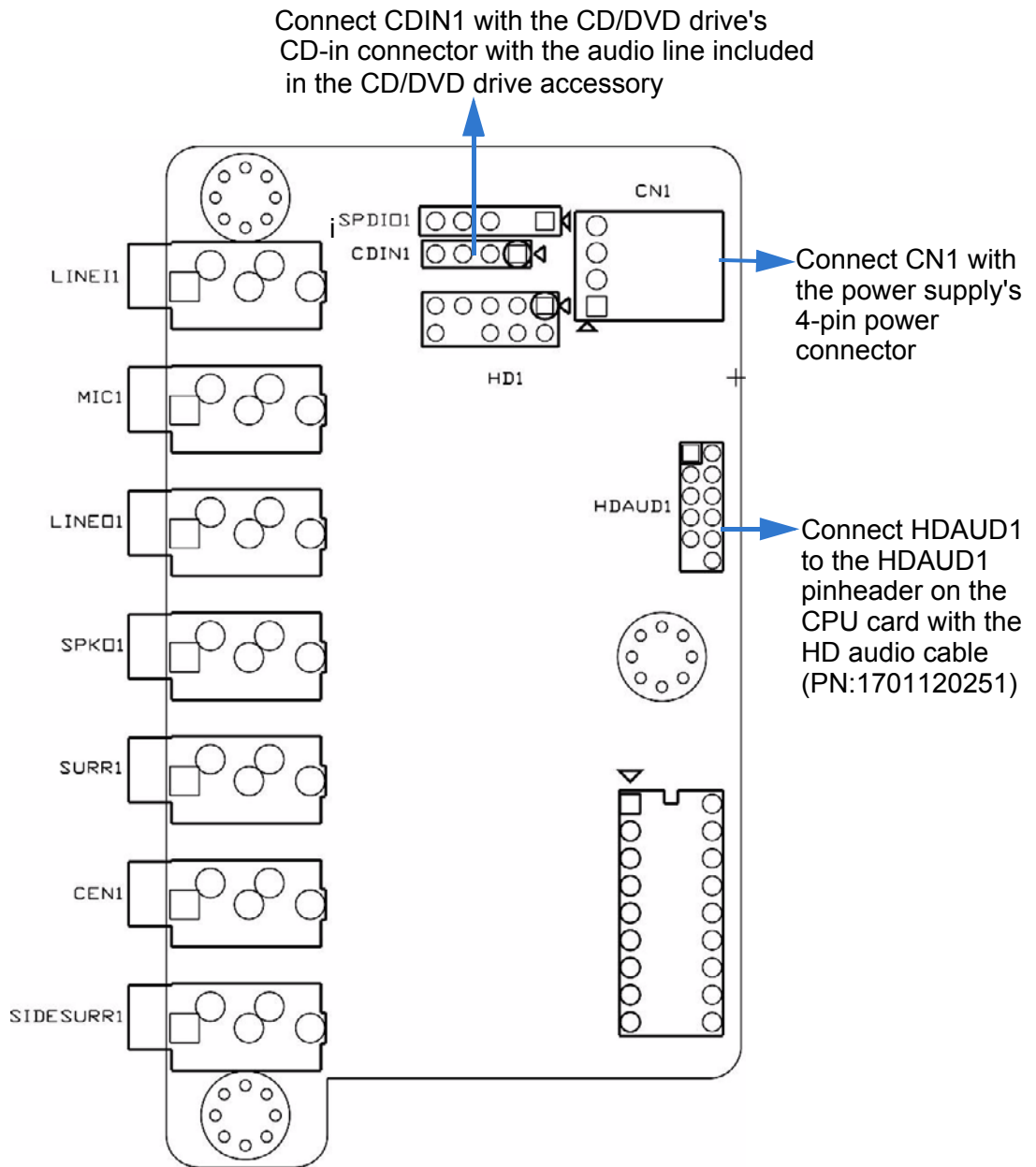
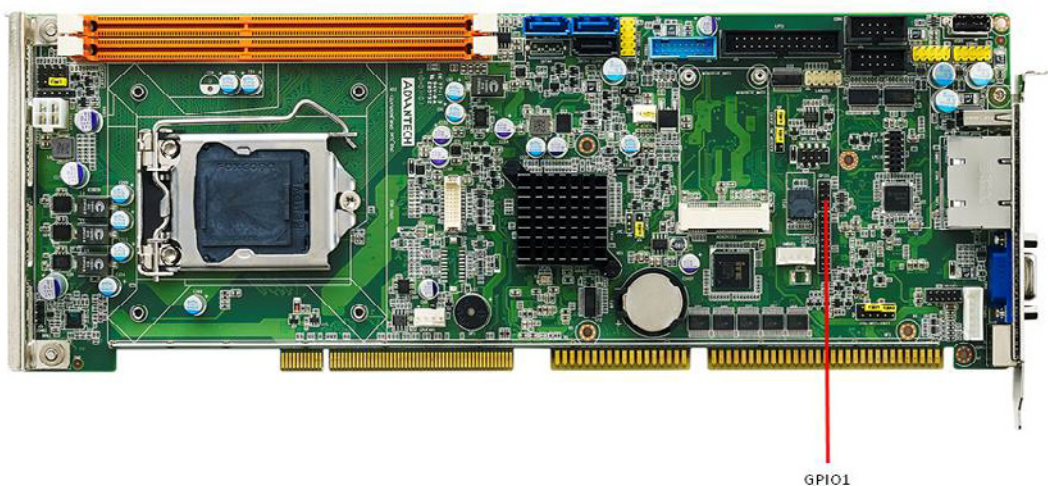

Figure 2.1 Jumper and connector locations of PCA-AUDIO-HDA1E

Note! Please remove the yellow jumper cap on the CPU card's HDAUD1 pinheader before connecting the HD audio cable to it.



2.12 GPIO Header (GPIO1)



Provides 10-Pin pin header for 8-bit Digital I/O usage. Refer to Appendix B for detailed information on the pin assignments and programming guide in Appendix C.

2.13 Case Open Connector (JCASE1)

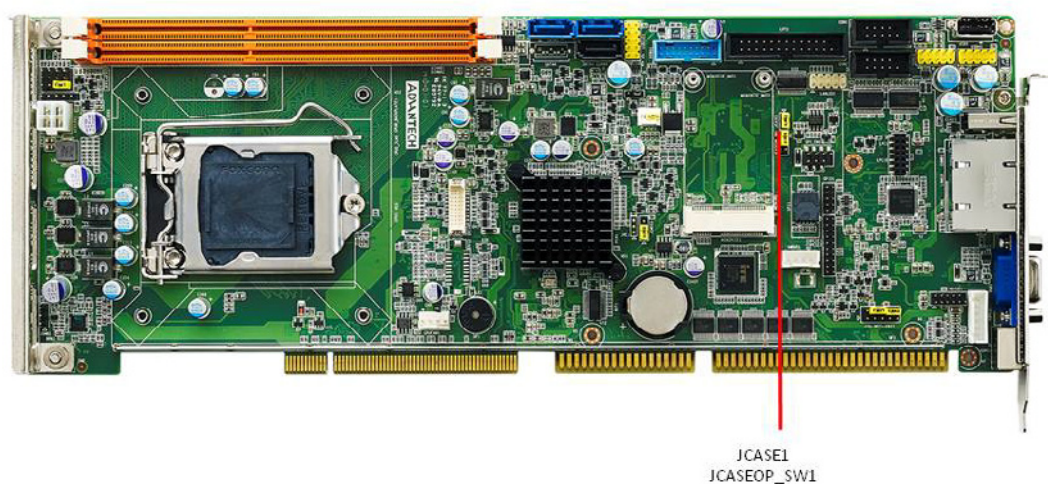

The 2-pin case open connector is for chassis with a case open sensor. When the case is open, the buzzer on motherboard will beep.

2.14 Front Panel LAN Indicator Connector (LANLED1)

Table 2.3: LAN LED Indicators

LAN Mode	LED1	LED2
1000Mbps Link On	Green On	On
1000Mbps Active	Green on	Flash
1000Mbps Link Off	Off	Off
100Mbps Link On	Orange On	On
100Mbps Active	Orange On	Flash
100Mbps Link Off	Off	Off
10Mbps Link On	Off	On
10Mbps Active	Off	Flash
10Mbps Link Off	Off	Off

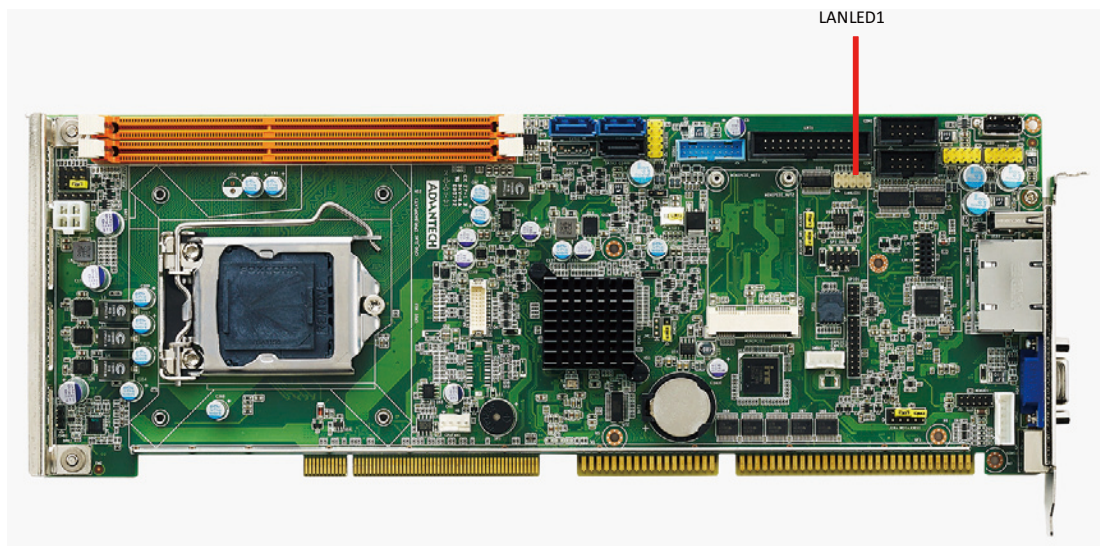

2.15 Serial ATA Interface (SATA1~SATA3)

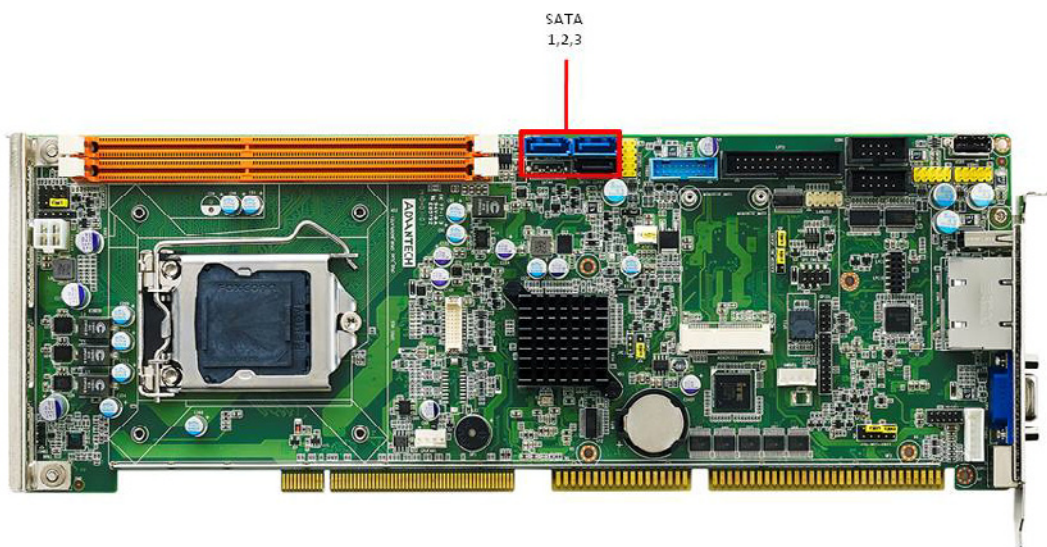

The PCA-6028 features high performance serial ATA interface (2* 600MB/s and 1* 300MB/s) which eases cabling to hard drivers or CD/DVD drivers with long cables.

Note! *When you install Linux OS, we recommend you to set AHCI mode in BIOS setting. It may recognize no hard drives when you use IDE mode during Linux OS installation.*



2.16 mSATA Connector (MINIPCI E1)

PCA-6028 provides a mSATA socket supporting transfer rate of 300 MB/s.

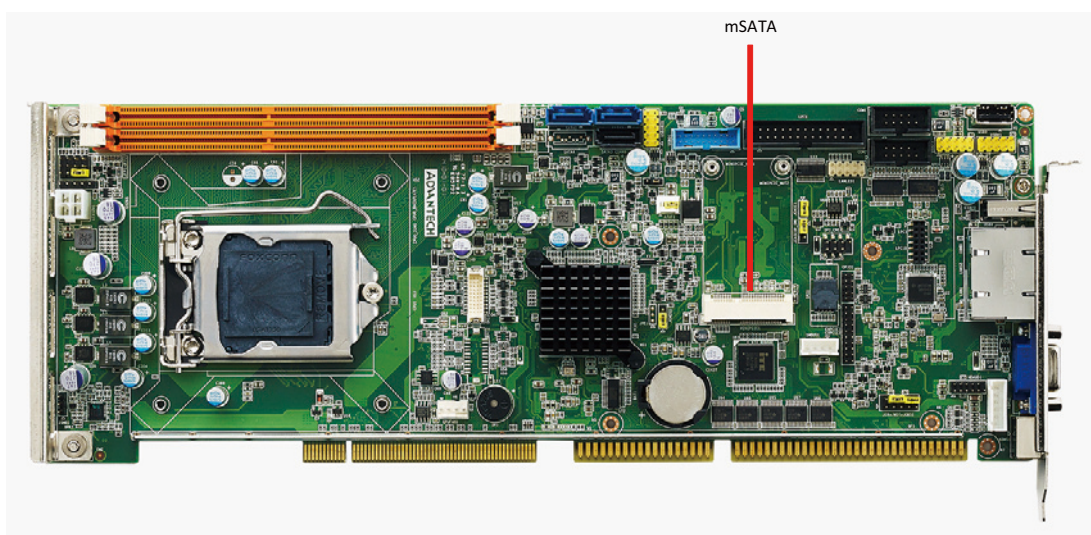

2.17 LPC Extension Interface (LPC1)

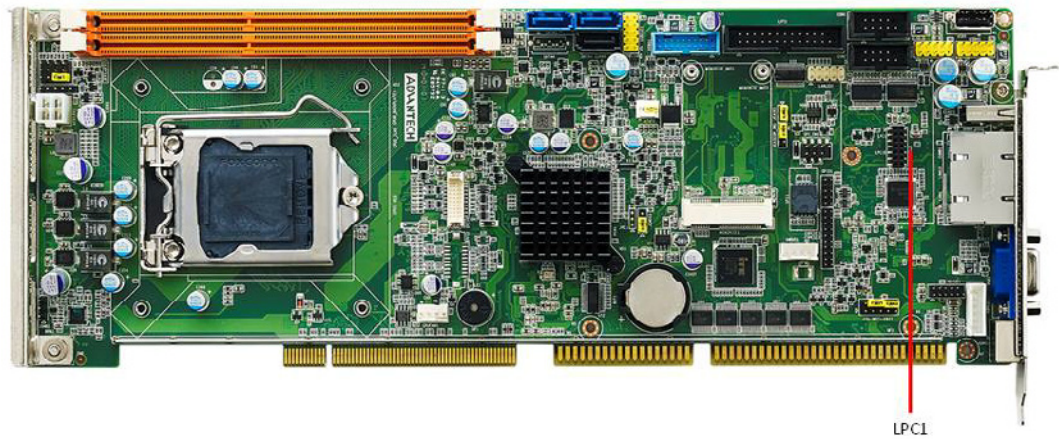

LPC1 is a 14-pin female pin header for adopting Advantech LPC module.

Chapter 3

AMI BIOS Setup

3.1 Introduction

AMI BIOS has been integrated into motherboards for over a decade. In the past, people often referred to the AMI BIOS setup menu as BIOS, BIOS setup or CMOS setup. With the AMI BIOS Setup program, you can modify BIOS settings and control the special features of your computer. The Setup program uses a number of menus for making changes and turning the special features on or off. This chapter describes the basic navigation of the PCA-6028 setup screens.

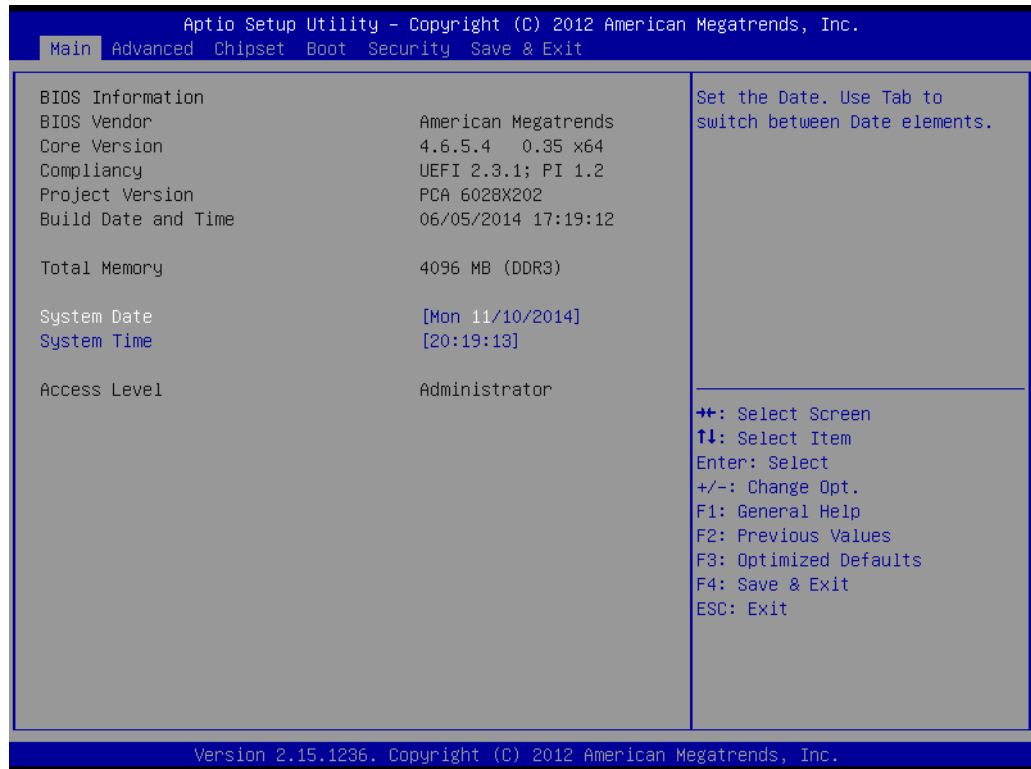

Figure 3.1 Setup program initial screen

3.2 Entering Setup

Turn on the computer and the BIOS is activated as well. The setup program can be triggered by pressing "DEL" or "F2" key.

Note! *If the message disappears before you press the "DEL" or "F2" key, please restart the computer and try it again.*



3.2.1 Main Setup

When you first enter the BIOS Setup Utility, you will enter the Main setup screen. You can always return to the Main setup screen by selecting the Main tab. There are two Main Setup options. They are described in this section. The Main BIOS Setup screen is shown below.

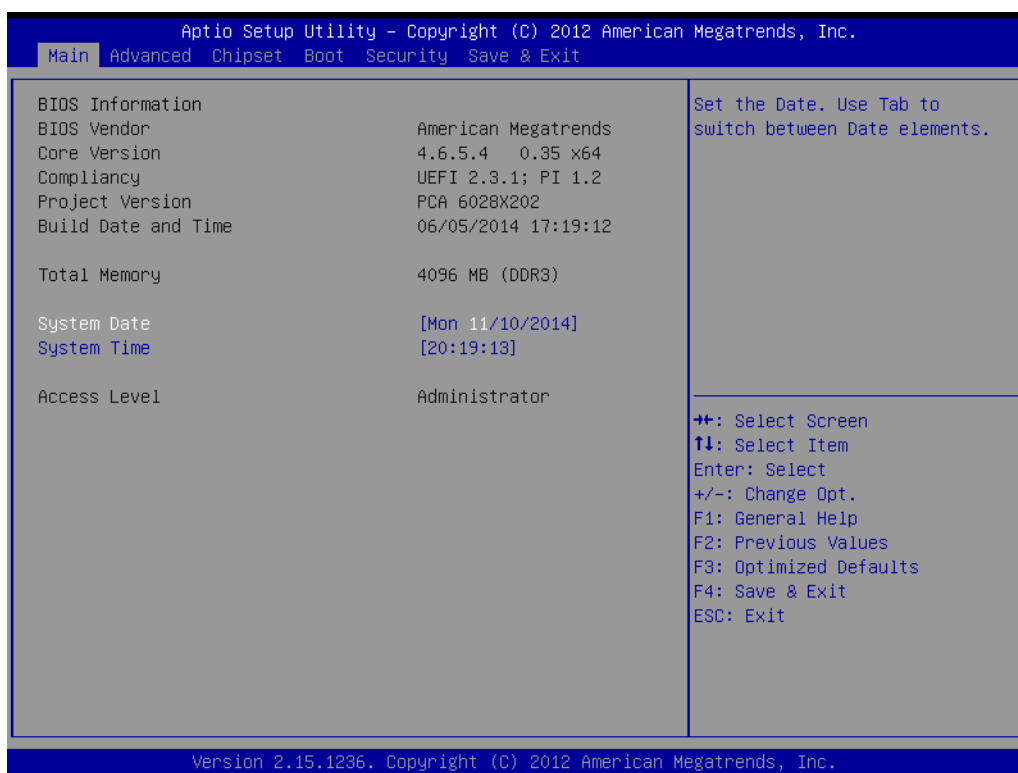

Figure 3.2 Main setup screen

The Main BIOS setup screen has two main frames. The left frame displays all the options that can be configured. Grayed-out options cannot be configured; options in blue can. The right frame displays the key legend.

Above the key legend is an area reserved for a text message. When an option is selected in the left frame, it is highlighted in white. Often a text message will accompany it.

- **System Time / System Date**

Use this option to change the system time and date. Highlight System Time or System Date using the <Arrow> keys. Enter new values through the keyboard. Press the <Tab> key or the <Arrow> keys to move between fields. The date must be entered in MM/DD/YY format. The time must be entered in HH:MM:SS format.

3.2.2 Advanced BIOS Features Setup

Select the Advanced tab from the PCA-6028 setup screen to enter the Advanced BIOS Setup screen. You can select any of the items in the left frame of the screen, such as CPU Configuration, to go to the sub menu for that item. You can display an Advanced BIOS Setup option by highlighting it using the <Arrow> keys. All Advanced BIOS Setup options are described in this section. The Advanced BIOS Setup screen is shown below, and the sub menus are described on the following pages.



Figure 3.3 Advanced BIOS features setup screen

3.2.2.1 PCI Subsystem Settings

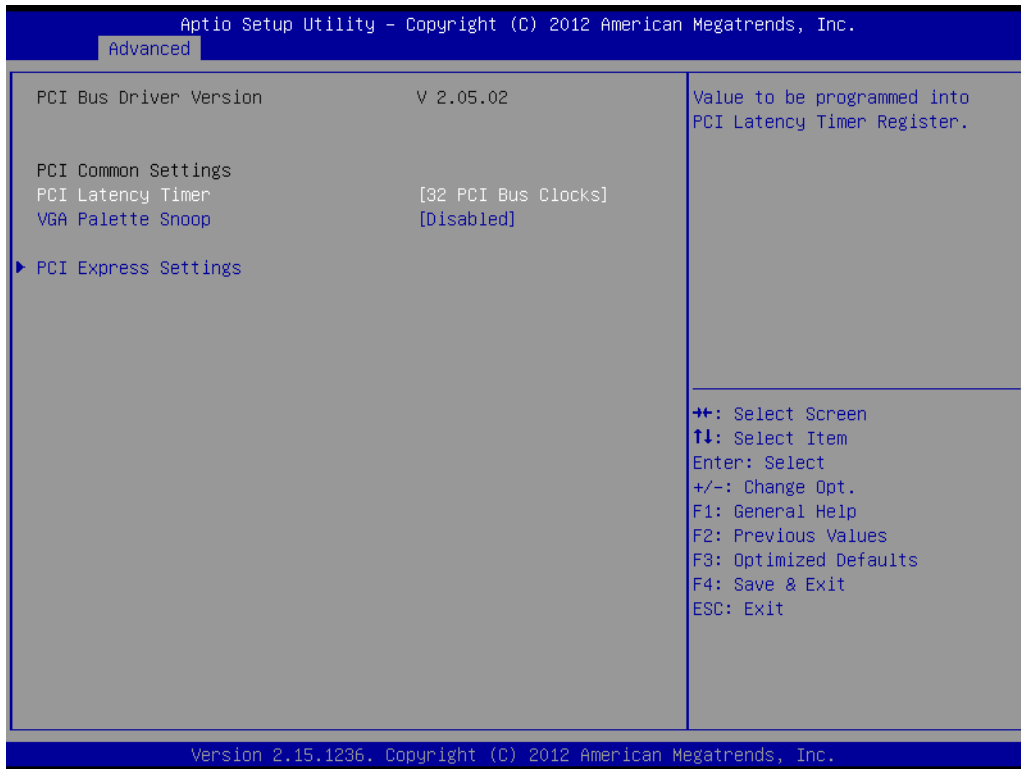

Figure 3.4 PCI Subsystem Settings

- **PCI Common Settings**
 - **PCI Latency Timer**
Value to be programmed into PCI Latency Timer Register.
 - **VGA Palette Snoop**
Enable or disable VGA palette registers snooping.

3.2.2.2 ACPI Settings

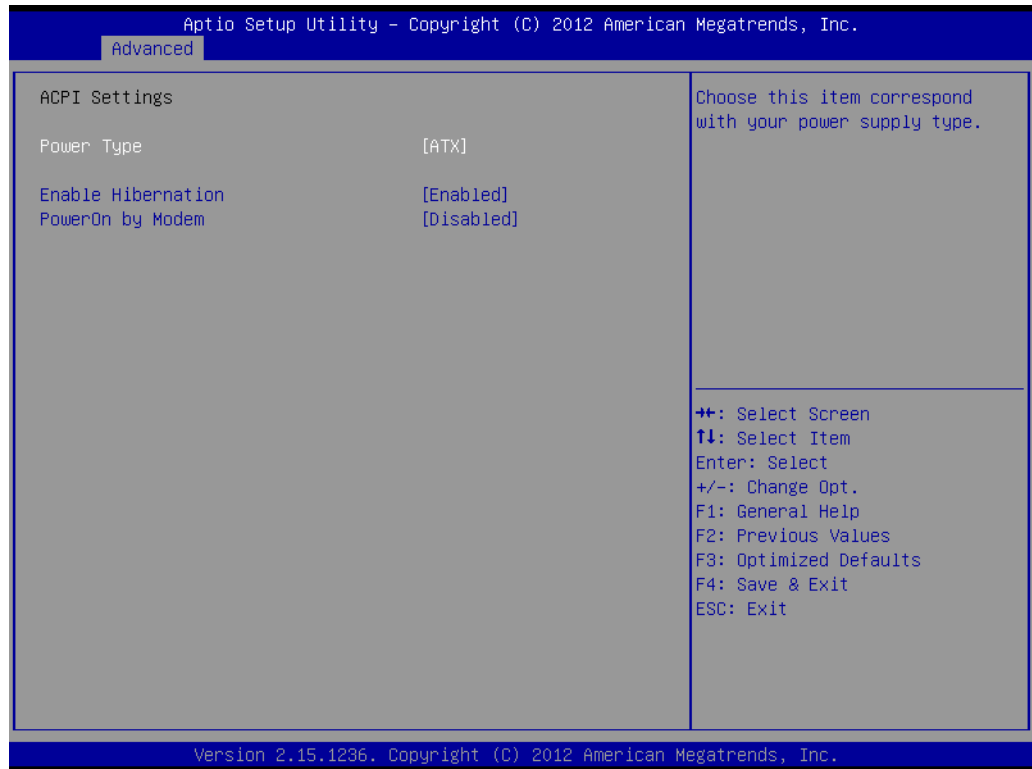

Figure 3.5 ACPI Settings

- **Power Type**
Choose this item correspond with your power supply type ATX or AT.
- **Enable Hibernation**
Enable or disable Hibernation (OS/S4 Sleep State). This option may not be effective with some OS.
- **PowerOn by Modem**
Enable or disable PowerOn by Modem.

3.2.2.3 Trusted Computing

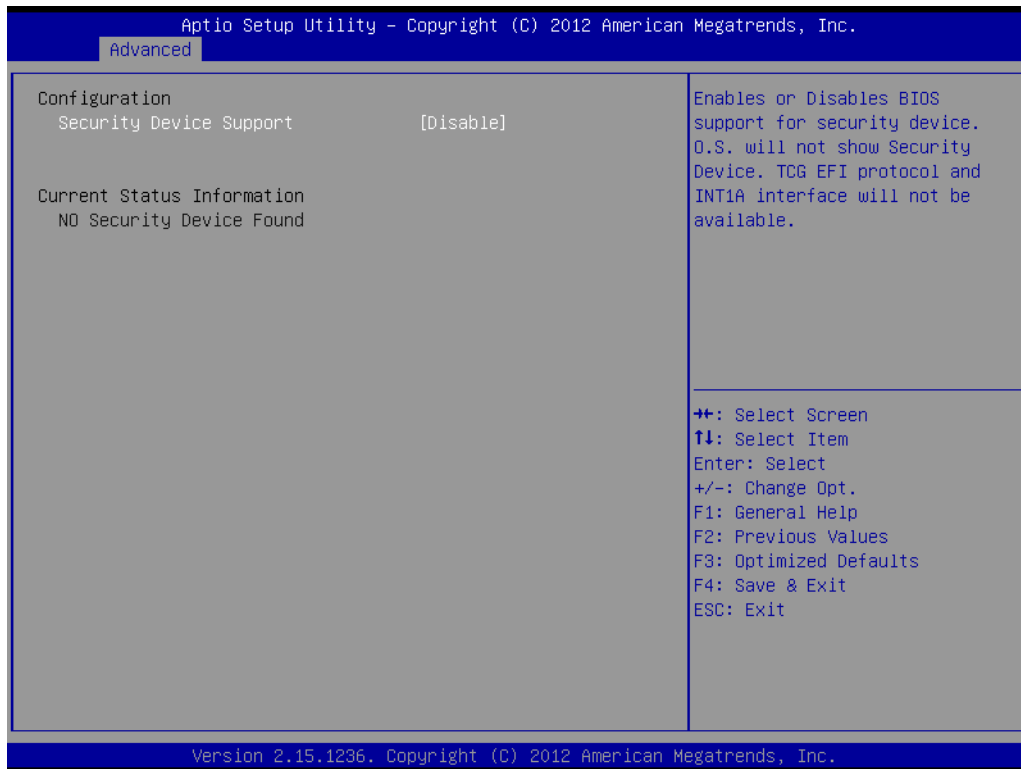

Figure 3.6 Trust Computing

- **Security Device Support**

Enable or disable BIOS for security device support. You can purchase Advantech TPM (Trust Platform Module) PCA-TPM-00A1E for your security device.

3.2.2.4 S5 RTC Wake Setting



Figure 3.7 S5 RTC configuration

- **Wake System with Fixed Time**
Enable or disable system wake on alarm event, When enabled, the system will wake on the hr:min:sec as specified.

3.2.2.5 CPU Configuration

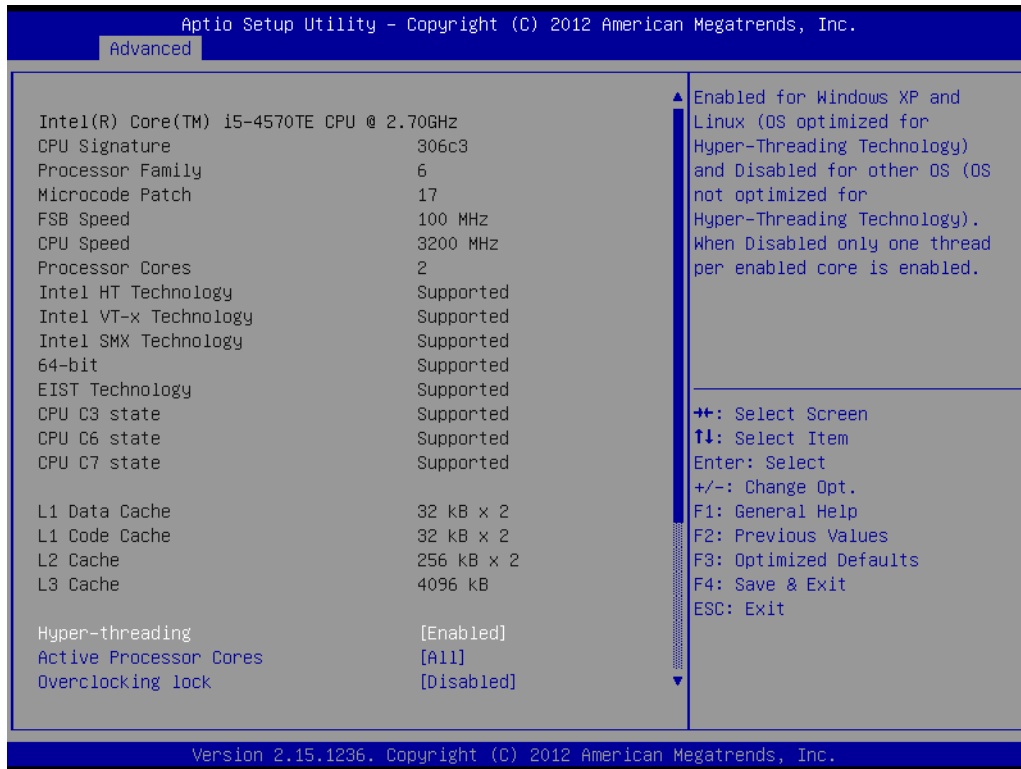

Figure 3.8 CPU Configuration

- **Active Processor Core**
Use this to select how many processor cores you want to activate when you are using a dual or quad core processor.
- **Overclocking lock**
Enable or Disable the overclocking lock function.
- **Limit CPUID Maximum**
Setting this item to [Enable] allows legacy operating systems to boot even without support for CPUs with extended CPUID functions.
- **Execute Disable Bit**
This item specifies the Execute Disable Bit Feature. The settings are Enabled and Disabled. The Optimal and Fail-Safe default setting is Enabled. If Disabled is selected, the BIOS forces the XD feature flag to always return to 0.
- **Intel Virtualization Technology**
This feature is used to enable or disable the Intel Virtualization Technology (IVT) extension. It allows multiple operating systems to run simultaneously on the same system. It does this by creating virtual machines, each running its own x86 operating system.
- **Hardware Prefetcher**
Hardware Prefetcher is a technique that fetches instructions and/or data from memory into the CPU cache memory well before the CPU needs it, so that it can improve the load-to-use latency. You may choose to enable or disable it.
- **Adjacent Cache Line Prefetch**
The Adjacent Cache-Line Prefetch mechanism, like automatic hardware prefetch, operates without programmer intervention. When enabled through the BIOS, two 64-byte cache lines are fetched into a 128-byte sector, regardless of whether the additional cache line has been requested or not. You may choose to enable or disable it.

- **CPU C states**
Intel C states setting for power saving.
- **Intel TXT(LT) Support**
Enable or Disable Intel TXT support

3.2.2.6 SATA Configuration

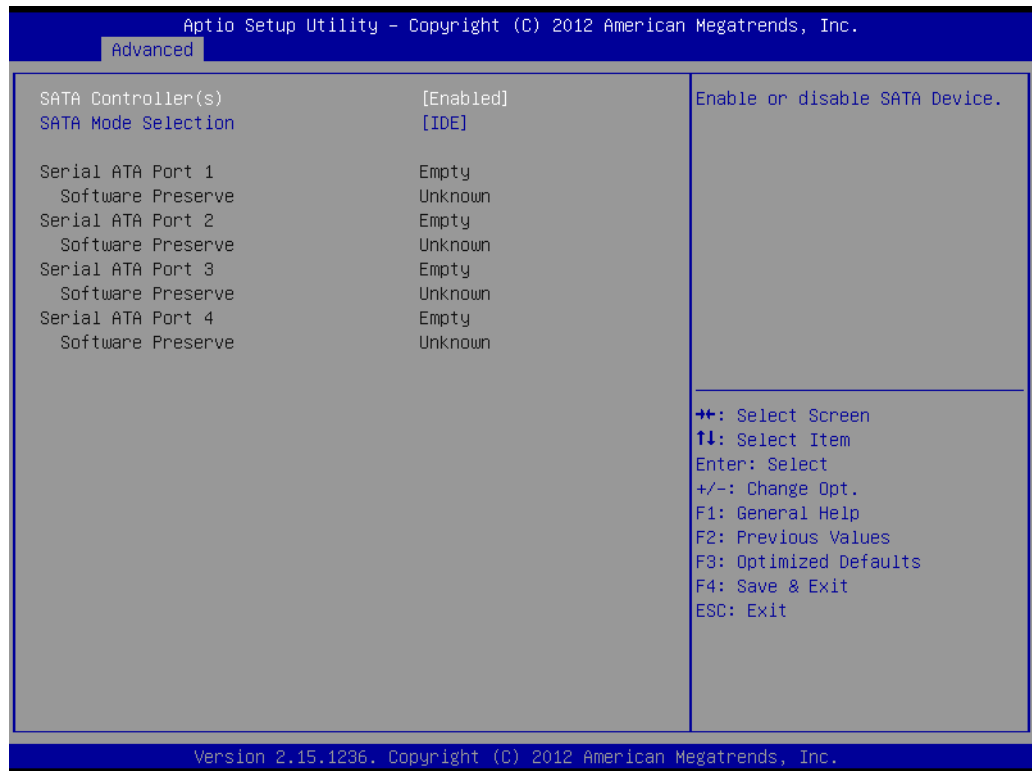
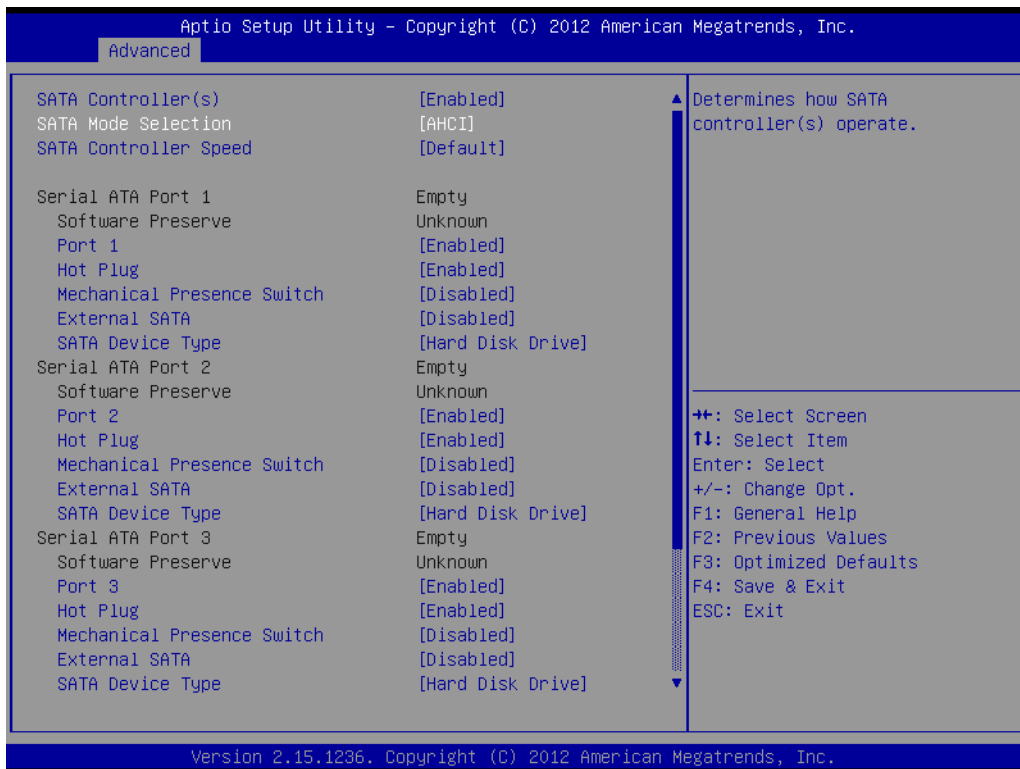

Figure 3.9 SATA Configuration

- **SATA Controller(s)**
Enable or disable SATA Device.
- **SATA Mode**
This can be configured as IDE and AHCI.



- **SATA Controller Speed**

Sets the maximum speed of SATA controllers, and there are three modes, Gen1, Gen2, and Gen3.

- **OROM UI Delay**

When this item is enable, user is able to indicate the delay of the OROM UI Splash Screen in a normal status.

- **Port 1~4**

To enable or disable SATA port 0~3.

- **Hot Plug**

Enable or disable SATA Hot-Plug

- **Port 1~4**

To identify the SATA is connected to Solid State Drive or Hard Disk Drive.

Note!  Some OS request to install under AHCI mode so please consult your local OS vendor for more detailed information. i.e. Fedora and Ubuntu requests to install under AHCI mode.

3.2.2.7 PCH-FW Configuration

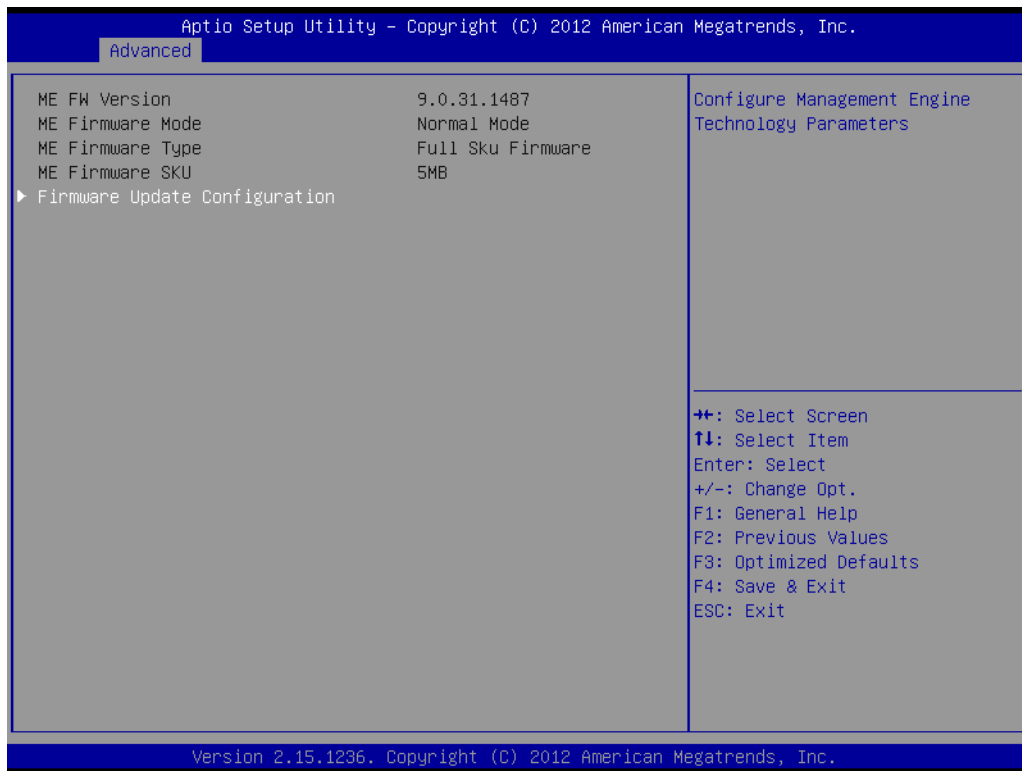

Figure 3.10 Firmware Update Configuration

- **ME FW Image Re-Flash**
Enable or disable ME FW Image Re-Flash function.

3.2.2.8 USB Configuration



Figure 3.11 USB Configuration

- **Legacy USB Support**
 This is for supporting USB devices under legacy OS such as DOS. When choosing "AUTO", the system will automatically detect if any USB device is plugged into the computer and enable USB legacy mode when a USB device is plugged in, and disable USB legacy mode when no USB device is plugged in.
- **USB3.0 support**
 Enable or disable USB3.0 (XHCI) support
- **XHCI Hand-off**
 This is a workaround for OS without XHCI hand-off support. The XHCI ownership change should be claimed by XHCI driver.
- **EHCI Hand-off**
 This is a workaround for OS without EHCI hand-off support. The EHCI ownership change should be claimed by EHCI driver.
- **USB Mass Storage Driver Support**
 Enable or disable USB Mass Storage Driver Support
- **USB transfer time-out**
 Allows you to select the USB transfer time-out value. [1,5,10,20sec]
- **Device reset time-out**
 Allows you to select the USB device reset time-out value. [1,5,10,20sec]
- **Device power-up delay**
 This item appears only when you set the Device power-up delay item to [manual].
- **USB Flash Driver PMAP**

3.2.2.9 Smart Setting

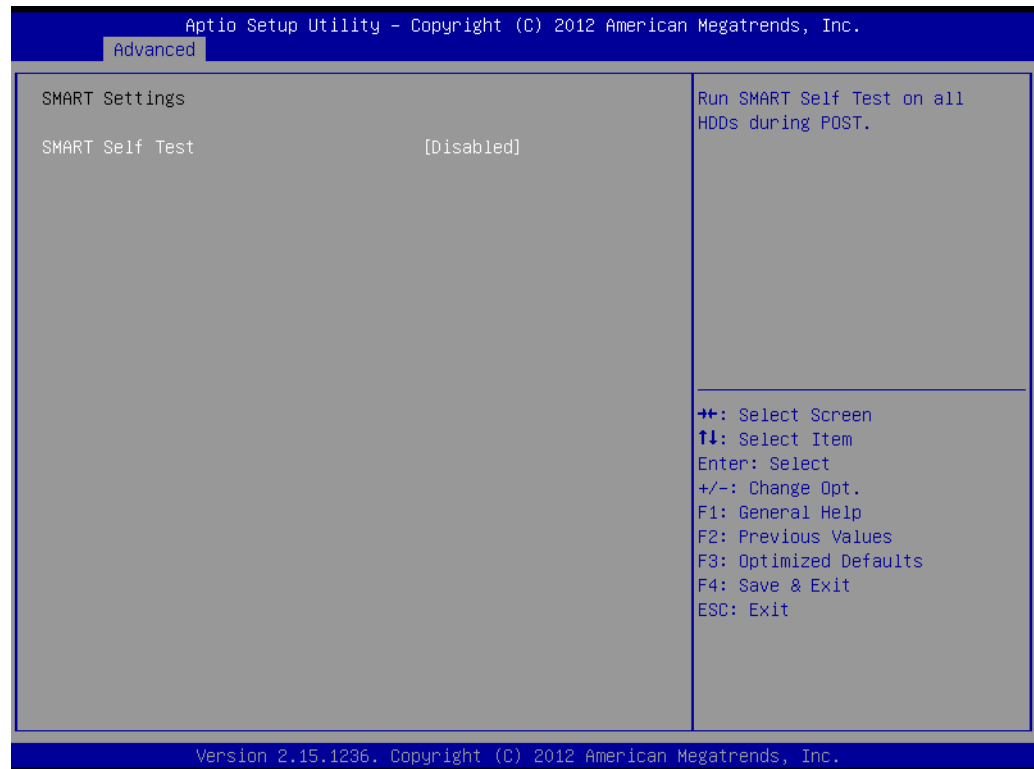

Figure 3.12 Smart Setting

- **Smart self test**
Run SMART Self Test on all HDDs during POST.

3.2.2.10 Super IO Configuration

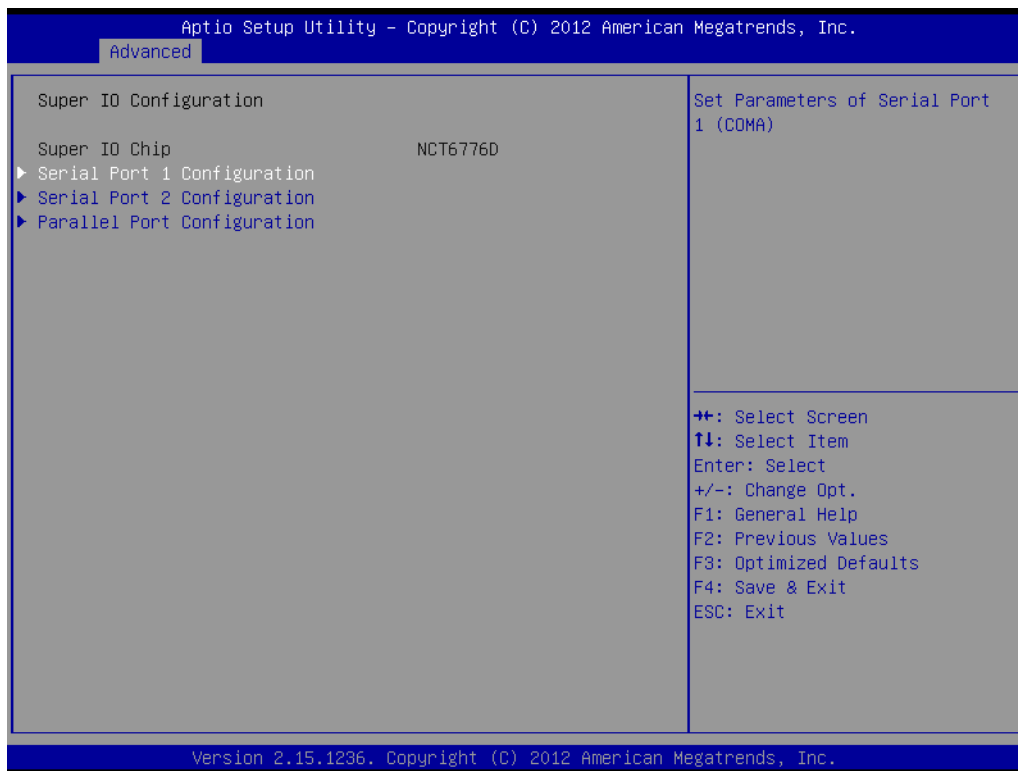

Figure 3.13 Super IO Configuration

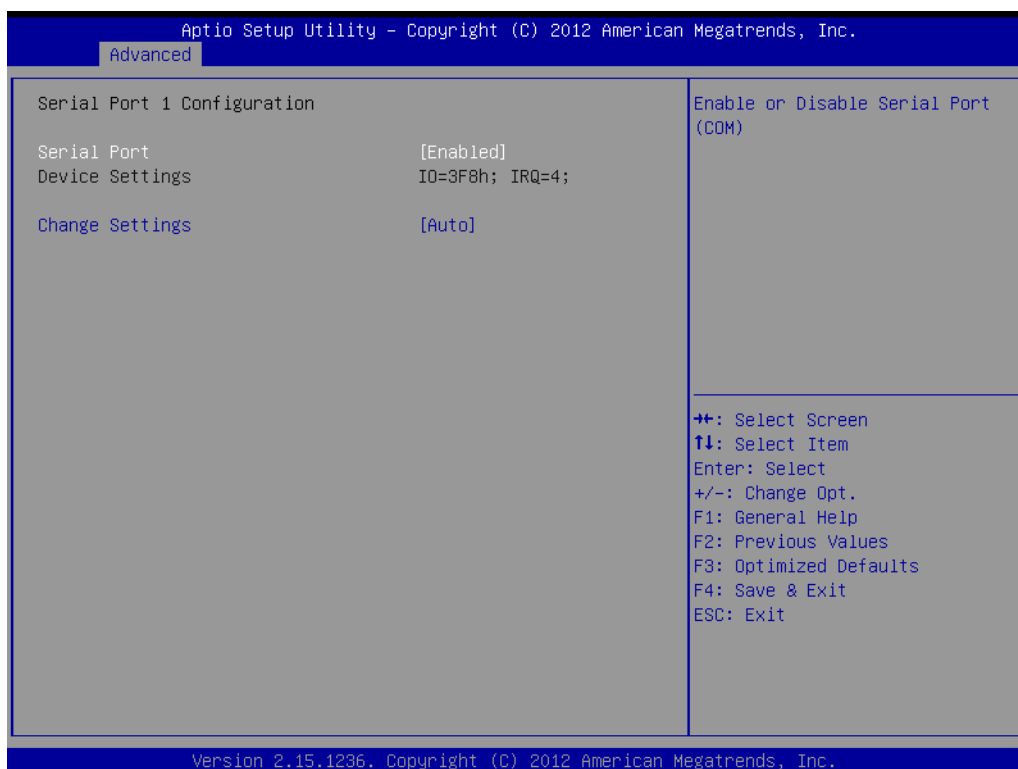

Figure 3.14 Serial Port 1 Configuration

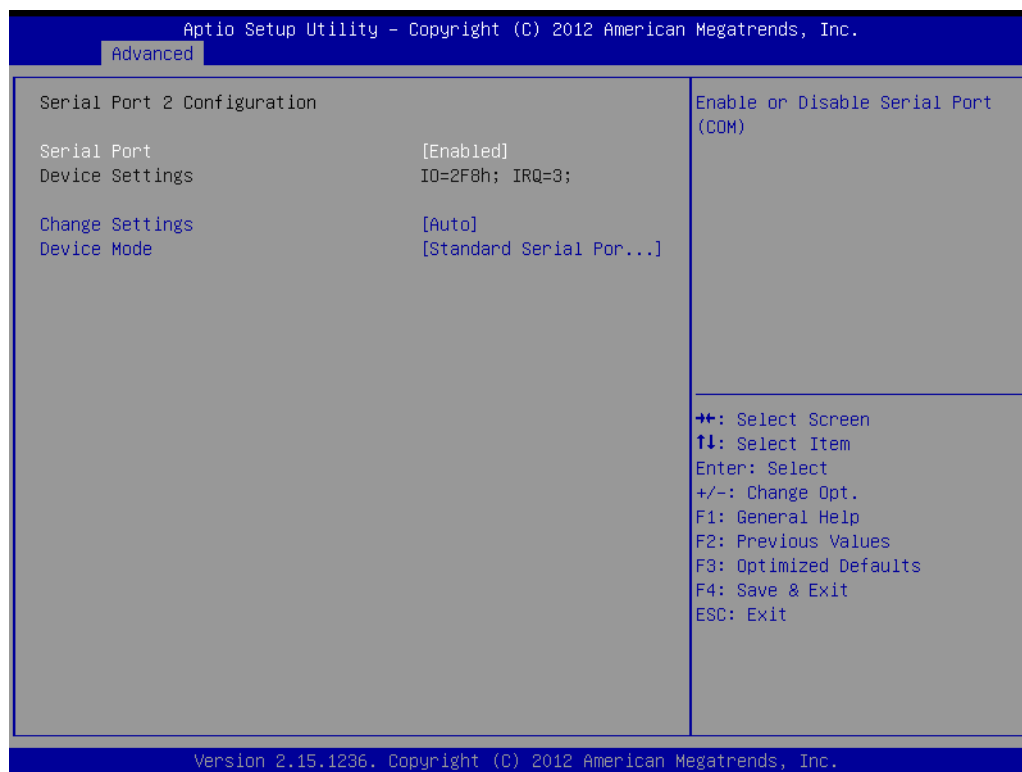

Figure 3.15 Serial Port 2 Configuration

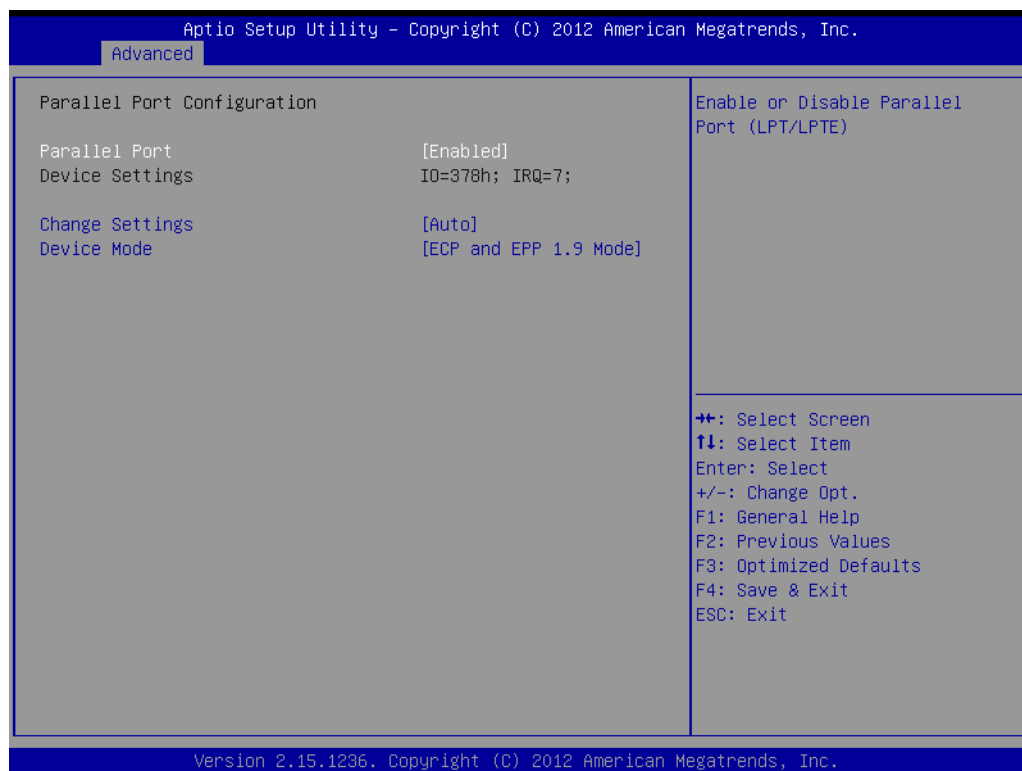

Figure 3.16 Parallel Configuration

- **Serial Port 1 -2 configuration**
Enable or disable serial ports.
- **Parallel Port configuration**
Enable or disable parallel port.

3.2.2.11 H/W Monitor

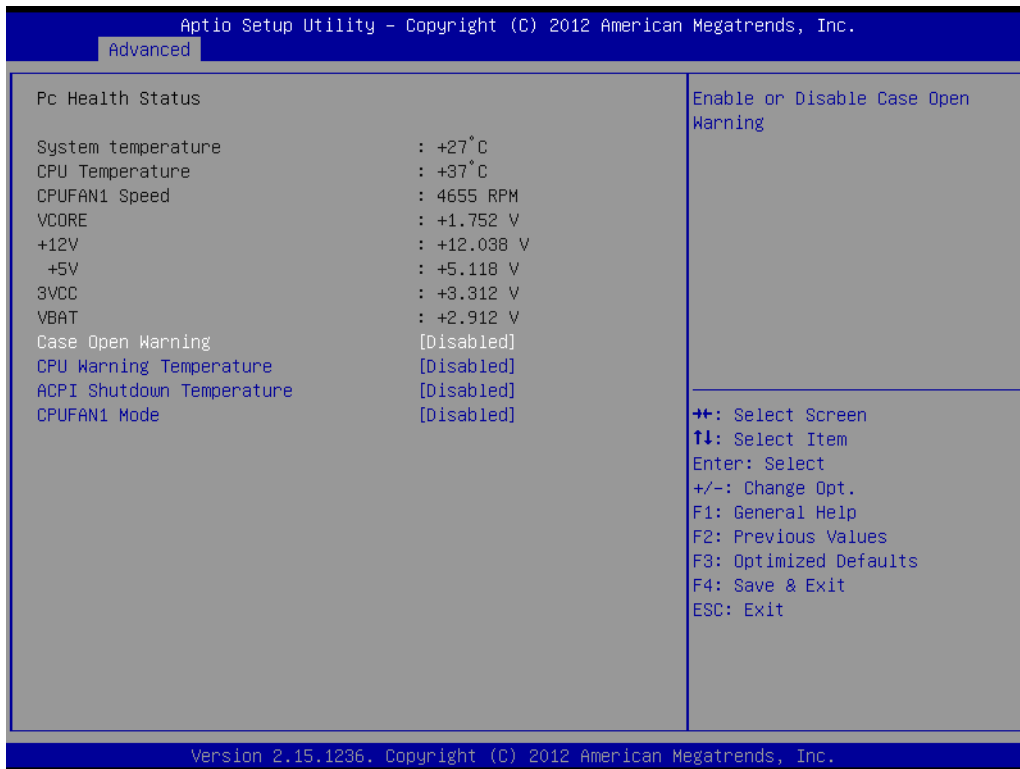

Figure 3.17 PC Health Status

- **Case Open Warning**
Enable or disable the Chassis Intrusion monitoring function. When enabled and the case is opened, the speaker beeps.
- **CPU Warning Temperature**
Use this to set the CPU warning temperature threshold. When the system reaches the warning temperature, the speaker will beep.
- **ACPI Shutdown Temperature**
Use this to set the ACPI shutdown temperature threshold. When the system reaches the shutdown temperature, it will be automatically shut down by ACPI OS to protect the system from overheating damage.
- **CPUFAN1 Mode**
Enable or disable the smart fan.

3.2.3 Chipset

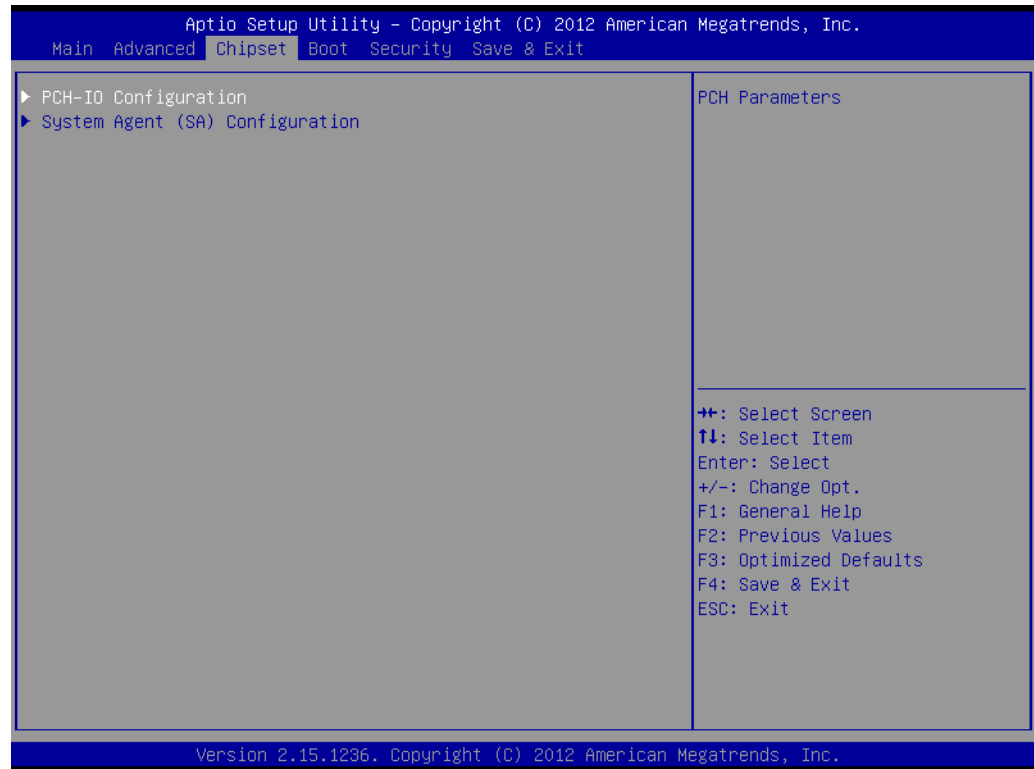

Figure 3.18 Chipset

3.2.3.1 PCH-IO Configuration

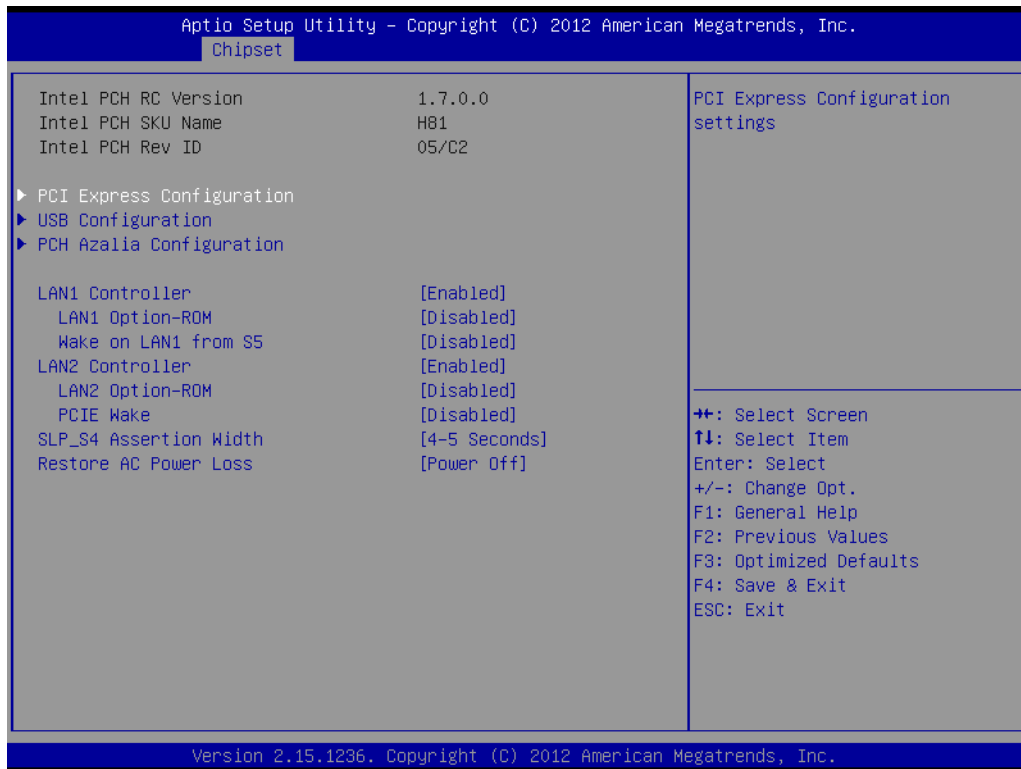

Figure 3.19 PCH IO Configuration

- **LAN1 Controller**
Enable or disable LAN1 controller.
 - **LAN 1 Option-ROM**
Enable or disable LAN 1 boot option for legacy network devices.
 - **Wake on LAN1 from S5**
Enable or disable LAN1 to wake the system. (The wake on LAN cannot be disabled if ME is on at Sx state).
- **LAN2 Controller**
Enable or disable LAN2 Controller.
 - **LAN 2 Option-ROM**
Enable or disable LAN 2 boot option for legacy network devices.
 - **PCIE Wake**
Enable or Disable PCIE to wake the system from S5.
- **SLP_S4 Assertion Width**
Select a minimum assertion width of the SLP_S4# signal.
- **Restore AC Power Loss**
Power Off, power On or Last State to restore AC power loss

3.2.3.2 USB Configuration

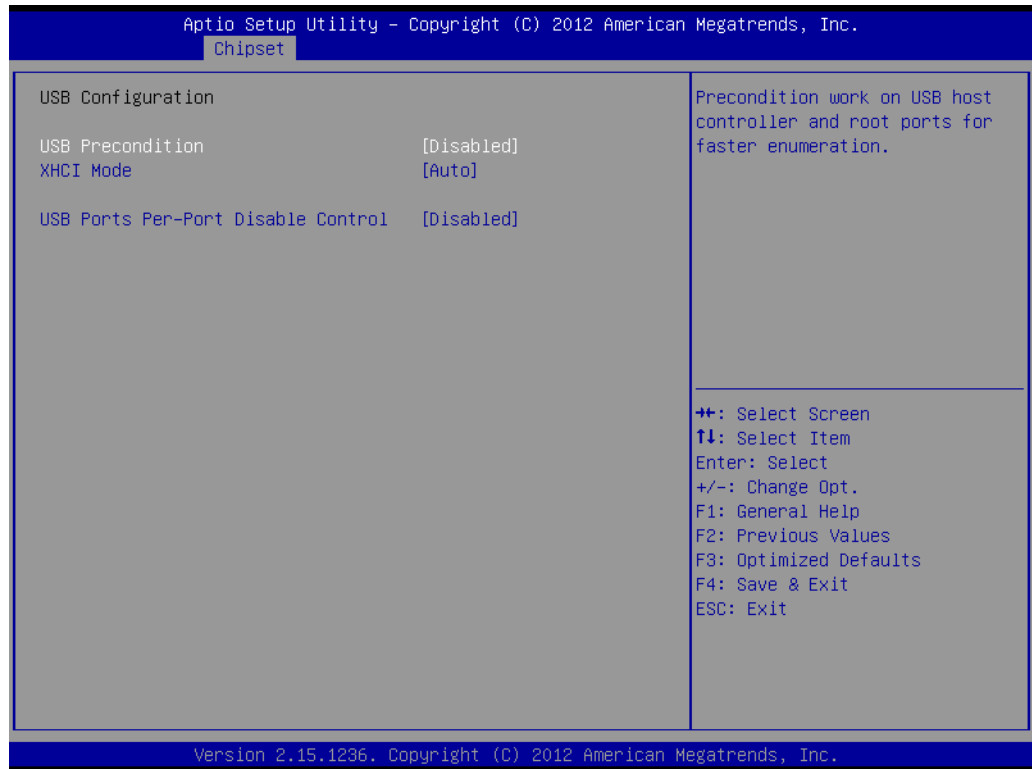

Figure 3.20 USB Configuration

- **USB Precondition**
Pre-condition on USB host controller and root ports for faster enumeration.
- **XHCI Mode**
Select Smart auto, Auto, Enable, and Disable mode of operation of XHCI controller.

Note! *Smart auto setting remembers last setting, but auto mode does not.*



- **USB Ports Pre-port Disable Control**
Controls each of the USB ports disabling.

3.2.3.3 PCH Azalia Configuration

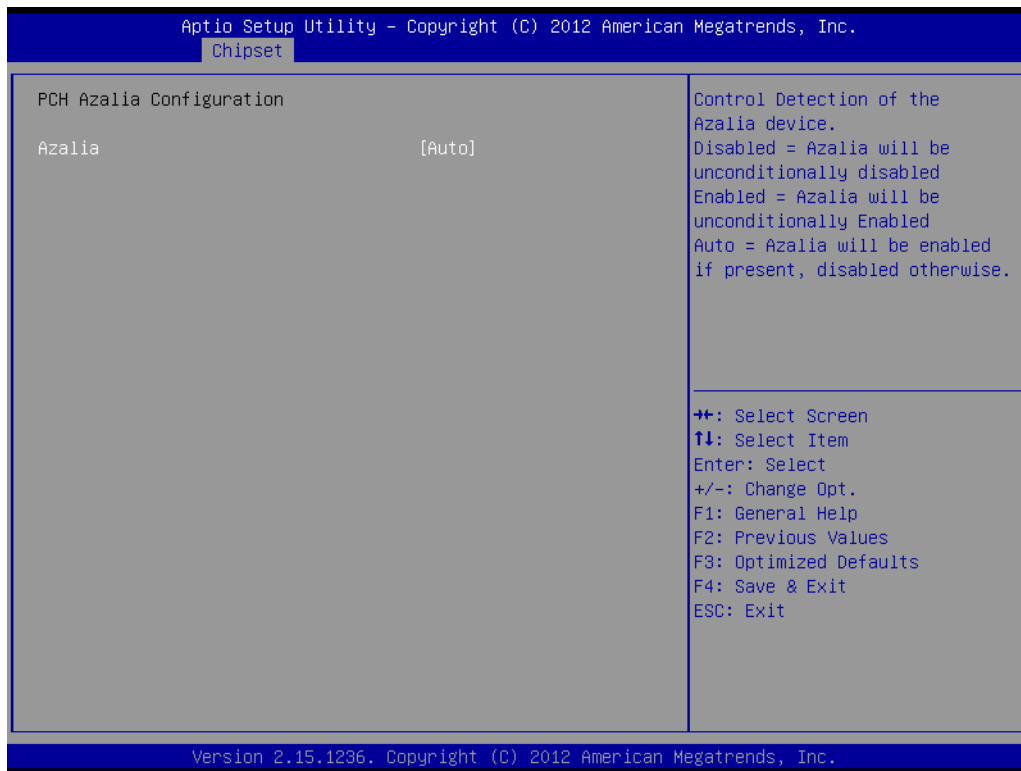

Figure 3.21 PCH Azalia Configuration

- **Azalia**
 Control detection of the Azalia device.
 Disable=Azalia will be unconditionally disabled.
 Enable=Azalia will be unconditionally enabled.
 Auto=Azalia will be enabled if present, disabled otherwise.

3.2.3.4 Graphics Configuration

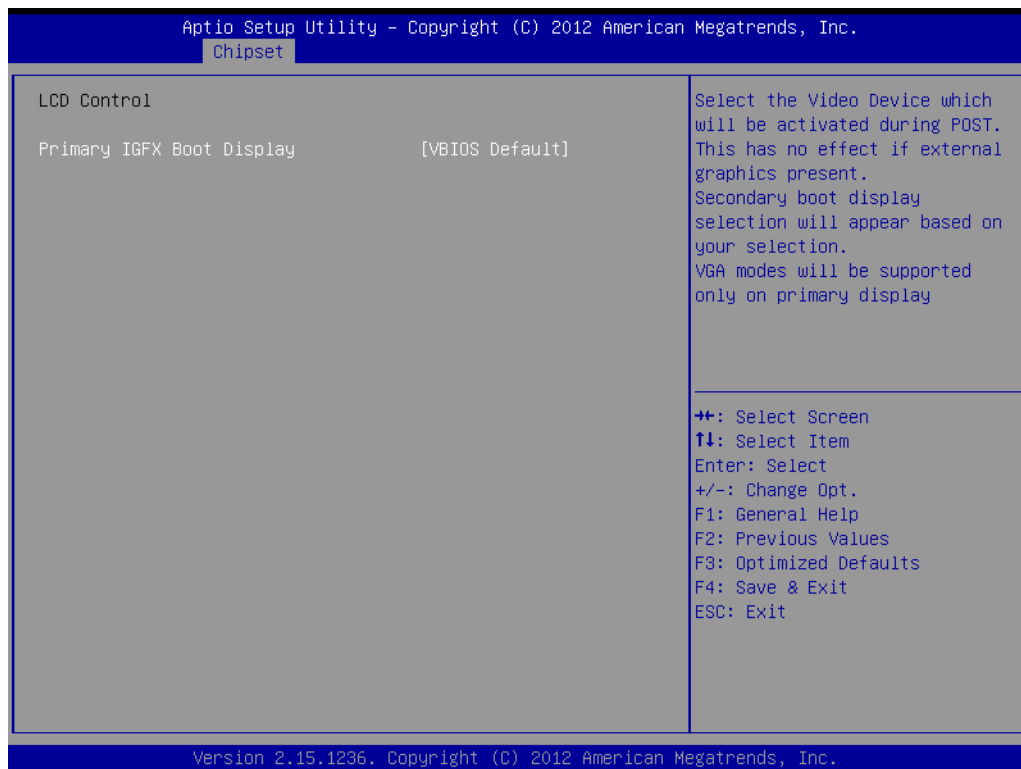
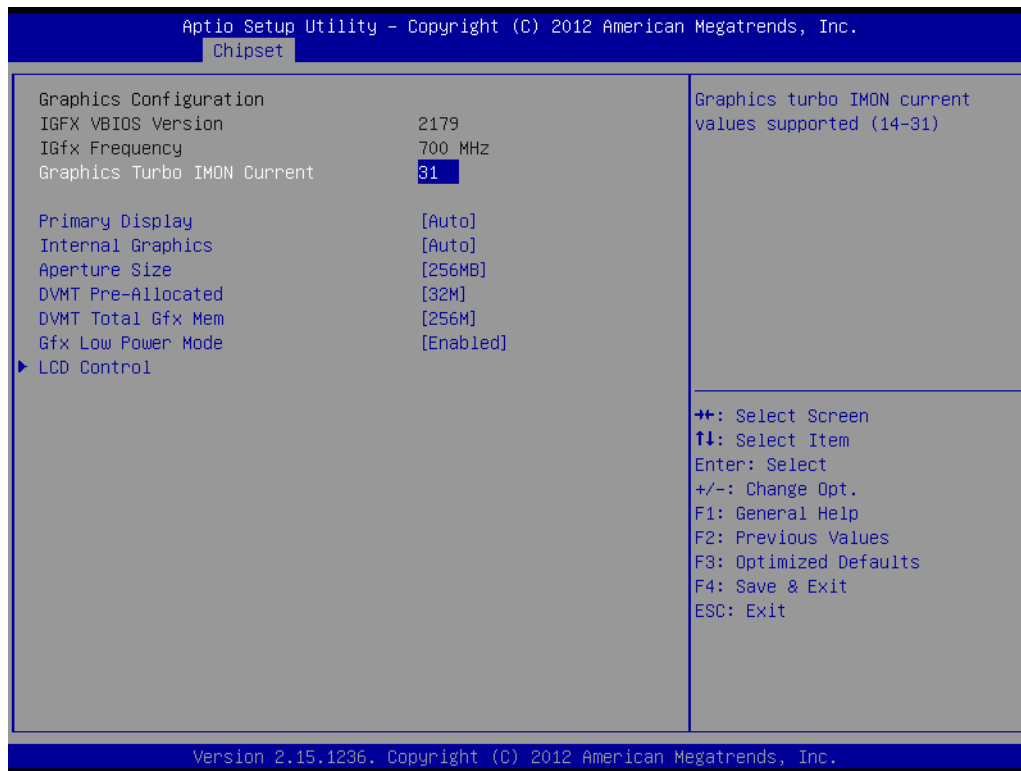

Figure 3.22 Graphics Configuration

- **Primary Display**
Select which IGFX/PEG/PCI graphics device should be primary display or select SG for switchable GFX.
- **Internal Graphics**
Keep IGD enabled based on the setup options.
- **Aperture Size**
Select the aperture size.
- **DVMT Pre-Allocated**
Select DVMT5.0 Pre-allocated (fixed) graphics memory size, up to 1024 M, used by the internal graphics device.
- **DVMT Total Gfx Mem**
Select 128 M, 256 M or MAX DVMT5.0 total graphics memory size used by the internal graphics device.
- **Gfx Low Power Mode**
Enable or disable Gfx Low power mode.
- **LCD Control**
Select Primary IGFX Boot Display (VBIOS Default, CRT, DVI1, DVI2).

3.2.3.5 Memory Configuration

Overview memory detail information.

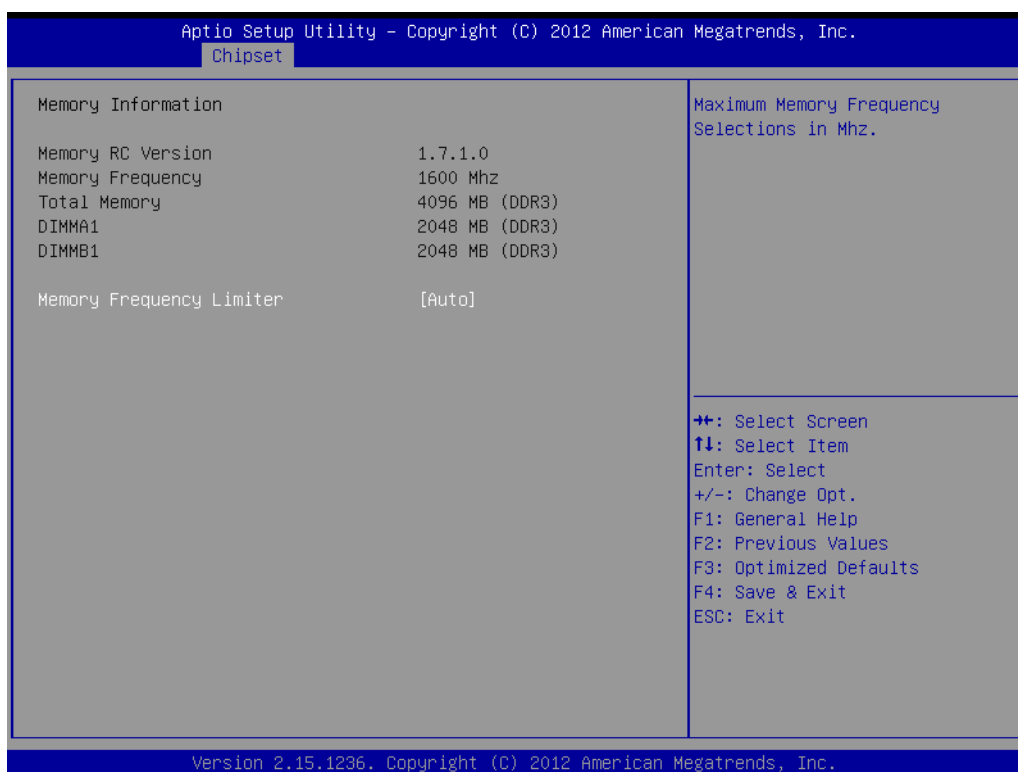

Figure 3.23 Memory Information

3.2.4 Boot

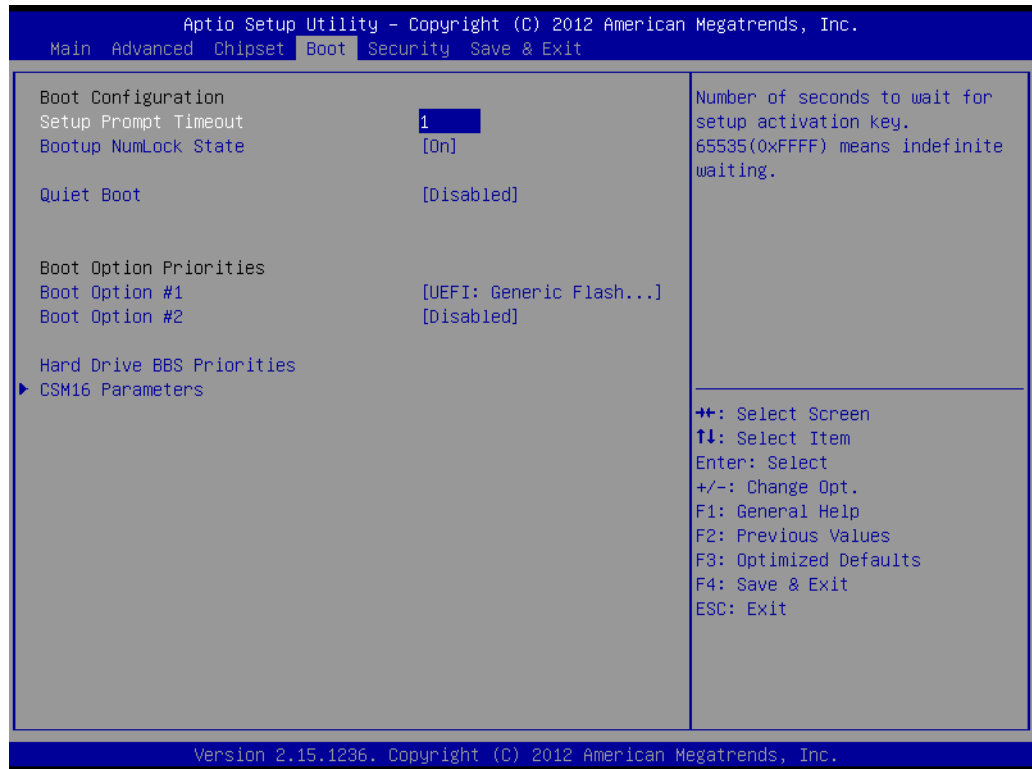
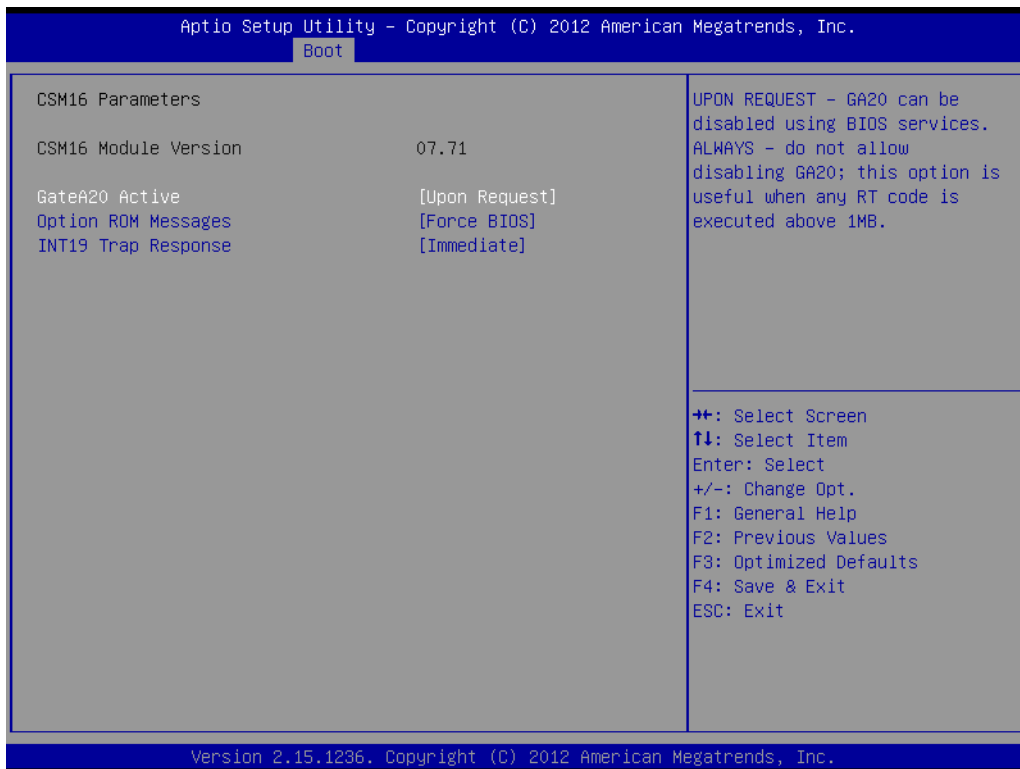

Figure 3.24 Boot

- **Setup Prompt Timeout**
Number of seconds to wait for setup activation key.
- **Bootup NumLock State**
Select the keyboard Numlock state.
- **Quiet Boot**
Enable or disable Quiet Boot option.
- **Boot Option Priorities**
you can see the information of boot priority option of devices.
- **Hard Drive BBS Priorities**
Set the order of the legacy devices in this group.
- **CSM16 Parameters**
Enable or disable Option ROM execution settings, etc.



- **GateA20 Active**
 Upon request-GA20 can be disabled using BIOS services.
 Always-do not allow disabling GA20; this option is useful when any RT code is executed above 1 MB.
- **Option Rom Messages**
 Set display mode for option ROM.
- **INT19 Trap Response**
 Bios reaction on INT19 trapping by option ROM:

3.2.5 Security

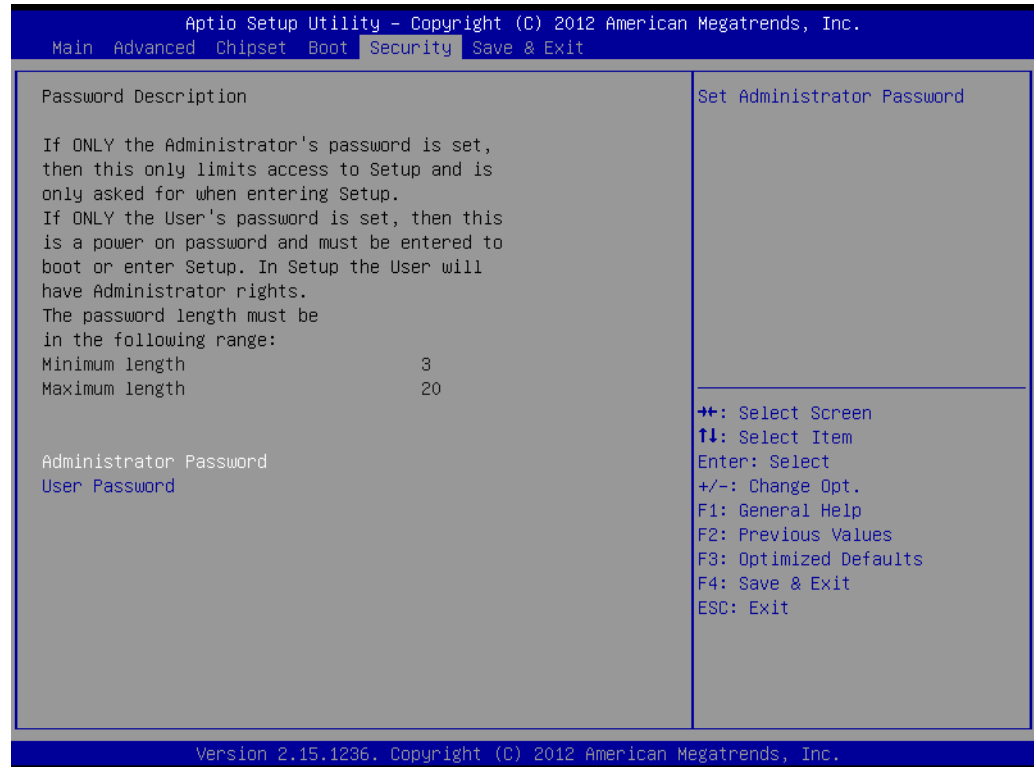

Figure 3.25 Security

Select Security Setup from the PCA-6028 main BIOS setup menu. All Security Setup options, such as password protection and virus protection are described in this section. To access the sub menu for the following items, select the item and press <Enter>

3.2.6 Save & Exit

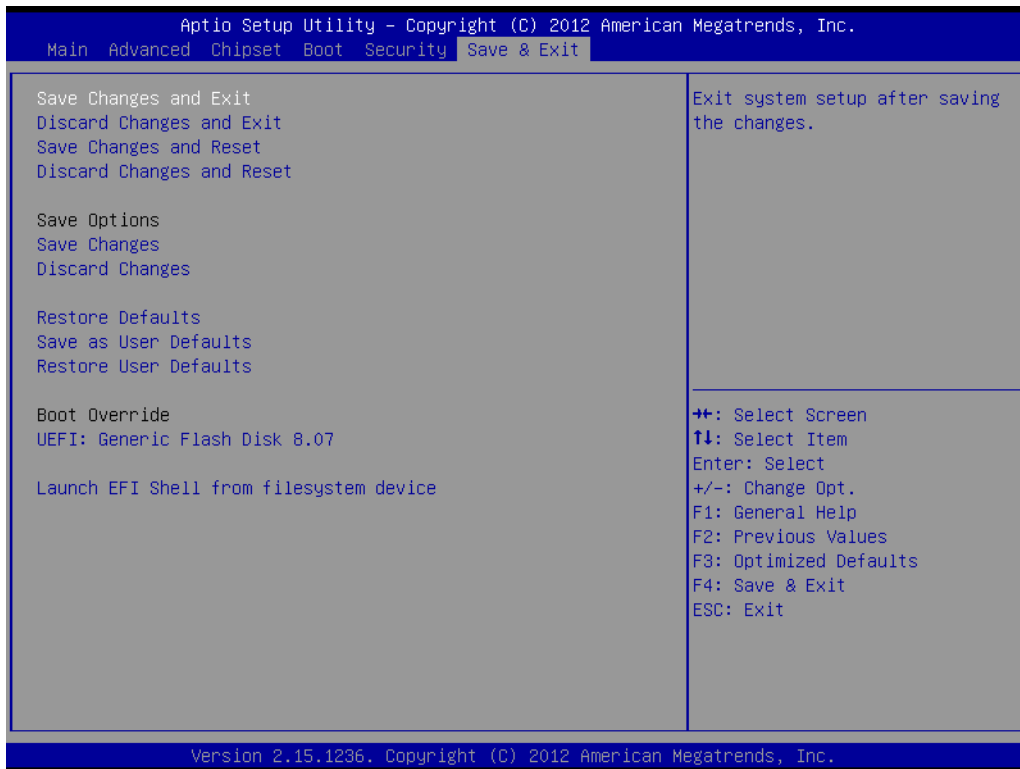

Figure 3.26 Save & Exit

- **Save changes and exit***
When you have completed system configuration, select this option to save your changes, exit BIOS setup and boot into the OS so the new system configuration parameters can take effect.
- **Discard changes and exit**
Select this option to quit Setup without making any permanent changes to the system configuration.
- **Save changes and Reset**
When you have completed system configuration, select this option to save your changes, exit BIOS setup and reboot into the computer so the new system configuration parameters can take effect.
- **Discard changes and Reset**
Select this option to quit Setup and reset computer without making any permanent changes to the system configuration.
- **Save Changes**
Select this option to save your changes.
- **Discard Changes**
Select this option to discard your changes.
- **Restore Defaults**
Select this option to restore BIOS configuration as origin.
- **Save as User Defaults**
Select this option to save user's configuration.
- **Restore User Defaults**
Select this option to restore BIOS to user's configuration.

- **Launch EFI Shell from file system device**

This option allows you to attempt to launch the EFI Shell application (shellx64.efi) from one of the available file system devices.

Note! *When you make some critical changes, the system will still reboot even if you choose "Save changes and exit".*



Chapter 4

Value-Added Software Services

4.1 Value-Added Software Services

Software API are interface that define the ways in which an application program may request services from libraries and/or operating systems. They provide not only the underlying drivers required but also a rich set of user-friendly, intelligent and integrated interfaces, which speed development, enhance security and offer add-on value for Advantech platforms. API plays the role of catalyst between developer and solution, and make Advantech embedded platforms easier and simpler to adopt and operate with customer applications. This API and utility is only for XP (32/64 bit), Win7 (32/64bit), and Win8 (32/64bit), so if users needs Linux version API and utility, then contact an Advantech representative for support. For Windows systems, please install the .Net Framework v 3.5 in the driver CD.

4.1.1 Software API

4.1.1.1 Control

GPIO



General Purpose Input/Output is a flexible parallel interface that allows a variety of custom connections. allows users to monitor the level of signal input or set the output status to switch on/off the device. Our API also provides Programmable GPIO, which allows developers to dynamically set the GPIO input or output status.

4.1.1.2 Monitor

Watchdog



A watchdog timer (WDT) is a device that performs a specific operation after a certain period of time if something goes wrong and the system does not recover on its own. A watchdog timer can be programmed to perform a warm boot (restarting the system) after a certain number of seconds.

Hardware Monitor



The Hardware Monitor (HWM) API is a system health supervision API that inspects certain condition indexes, such as fan speed, temperature and voltage.

4.1.2 Software Utility

Monitoring



The Monitoring utility allows the customer to monitor system health, including voltage, CPU and system temperature and fan speed. These items are important to a device; if critical errors happen and are not solved immediately, permanent damage may be caused.

Chapter 5

Chipset Software
Installation Utility

5.1 Before You Begin

To facilitate the installation of the enhanced display drivers and utility software, read the instructions in this chapter carefully. The drivers for the PCA-6028 are located on the software installation CD. The driver in the folder of the driver CD will guide and link you to the utilities and drivers for Windows. Updates are provided via Service Packs from Microsoft®.

Note! *The files on the software installation CD are compressed. Do not attempt to install the drivers by copying the files manually. You must use the supplied SETUP program to install the drivers.*



Before you begin, it is important to note that most display drivers need to have the relevant software application already installed in the system prior to installing the enhanced display drivers. In addition, many of the installation procedures assume that you are familiar with both the relevant software applications and operating system commands. Review the relevant operating system commands and the pertinent sections of your application software's user manual before performing the installation.

5.2 Introduction

The Intel® Chipset Software Installation (CSI) utility installs the Windows INF files that outline to the operating system how the chipset components will be configured. This is needed for the proper functioning of the following features:

- Core PCI PnP services
- Serial ATA interface support
- USB 1.1/2.0/3.0 support
- Identification of Intel® chipset components in the Device Manager
- Integrates superior video features. These include filtered sealing of 720 pixel DVD content, and MPEG-2 motion compensation for software DVD

5.3 Windows® 7 / Windows® 8 Driver Setup

1. Insert the driver CD into your system's CD-ROM drive. You can see the driver folder items. Navigate to the "00_Chipset" folder and click "infinst_autol.exe" to complete the installation of the driver.

Note! *Wrong driver installation may cause unexpected system instability.*



The drivers on this CD support both Windows 7 32-bit /64-bit and Windows 8 32-bit/64-bit.

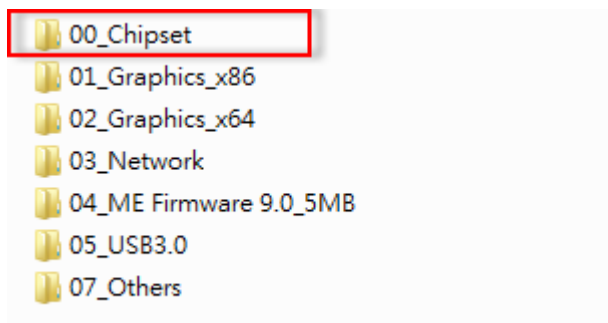

Chapter 6

Integrated Graphic
Device Setup

6.1 Introduction

4th generation Intel CPUs have integrated graphics controllers. You need to install the VGA driver to enable this function, which includes the following features:

- **Optimized integrated graphic solution:** Intel Graphics Flexible Display Interface supports versatile display options and 3D graphics engine. Triple independent display, enhanced display modes for widescreen flat panels for extend, twin, and clone dual display mode, and optimized 3D support deliver an intensive and realistic visual experience.

6.2 Windows 7/ Windows 8 Driver Setup

Note! Before installing this driver, make sure the INF driver has been installed in your system. See Chapter 5 for information on installing the INF driver.



Insert the driver CD into your system's CD-ROM drive. You can see the driver folder items. Navigate to the "01_Graphics_x86 or 02_Graphics_x64" folder and click "setup.exe" to complete the installation of the driver.

Note! Wrong driver installation may cause unexpected system instability.

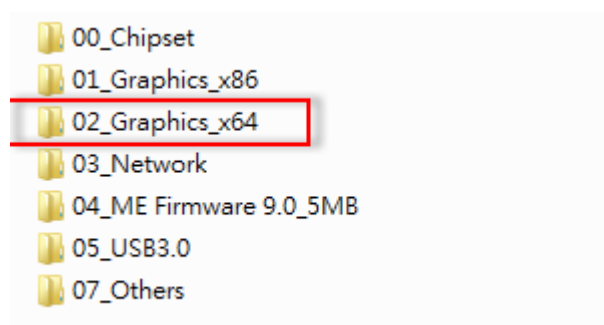
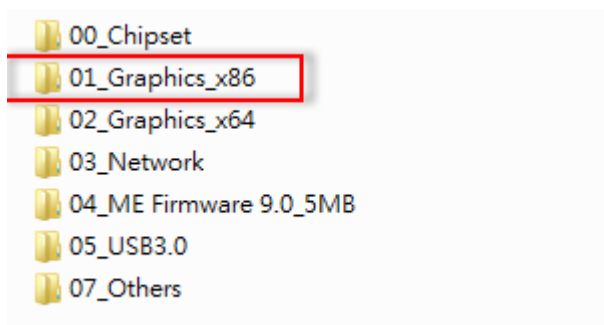

Chapter 7

LAN Configuration

7.1 Introduction

The PCA-6028 has dual Gigabit Ethernet LANs via dedicated PCI Express x1 lanes (Intel I217V (LAN1) and I211 (LAN2 in G2)) that offer bandwidth of up to 500 MB/sec, eliminating the bottleneck of network data flow and incorporating Gigabit Ethernet at 1000 Mbps.

7.2 Installation

Note! Before installing the LAN drivers, make sure the CSI utility has been installed on your system. See Chapter 5 for information on installing the CSI utility.



The PCA-6028's Intel I217V (LAN1) and I211 (LAN2 in G2) Gigabit integrated controllers support all major network operating systems. However, the installation procedure varies from system to system. Please find and use the section that provides the driver setup procedure for the operating system you are using.

7.3 Win XP /Win 7 Driver Setup (LAN)

Insert the driver CD into your system's CD-ROM drive. Navigate to the "03_Network" folder and click "Autorun.exe" to complete the installation of the driver.

Note! Wrong driver installation may cause unexpected system instability.

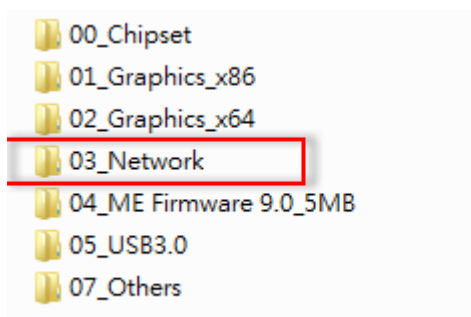

Chapter 8

Intel ME

8.1 Introduction

The Intel® ME software components that need to be installed depend on the system's specific hardware and firmware features. The installer detects the system's capabilities and installs the relevant drivers and applications.

8.2 Installation

Insert the driver CD into your system's CD-ROM drive. Navigate to the "04_ME Firmware 9.0_5MB" folder and click "setup.exe" to complete the installation of the driver.

Note! *If the Intel® Management Engine (Intel® ME) driver has not been successfully installed, you may see an error on a "PCI Simple Communications Controller" in Device Manager.*



Chapter 9

Intel USB 3.0

9.1 Introduction

PCA-6028 provides Intel® USB 3.0 and the data transfer rates of USB 3.0 (5 Gbps) which is 10 times faster than USB 2.0 (480Mbps).

9.2 Installation

Insert the driver CD into your system's CD-ROM drive. Navigate to the "05_USB3.0" folder and click "setup.exe" to complete the installation of the driver.

Note! *The Intel® USB 3.0 eXtensible Host Controller Driver is not supported on Windows* XP and Windows* Vista. For these operating systems, ensure your BIOS settings have the xHCI Mode set to "Auto" or "Smart Auto". This will reconfigure the USB 3.0 ports to function as USB 2.0 ports using the native Windows* EHCI driver.*

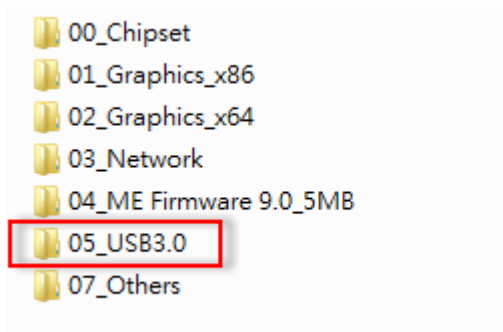

Appendix **A**

Programming the Watchdog Timer

A.1 Introduction

The PCA-6028's watchdog timer can be used to monitor system software operation and take corrective action if the software fails to function within the programmed period. This section describes the operation of the watchdog timer and how to program it.

A.1.1 Watchdog timer overview

The watchdog timer is built in to the NCT6776D super I/O controller. It provides the following user programmable functions:

- Can be enabled and disabled via user's program
- Timer can be set from 1 to 255 seconds
- Generates a reset signal if the software fails to reset the timer before time-out

A.1.2 Programming the watchdog timer

The I/O port address of the watchdog timer is 2E (hex) and 2F (hex). 2E (hex) is the address port. 2F (hex) is the data port. You must first write an address value into address port 2E (hex), then write/read data to/from the assigned register through data port 2F (hex).

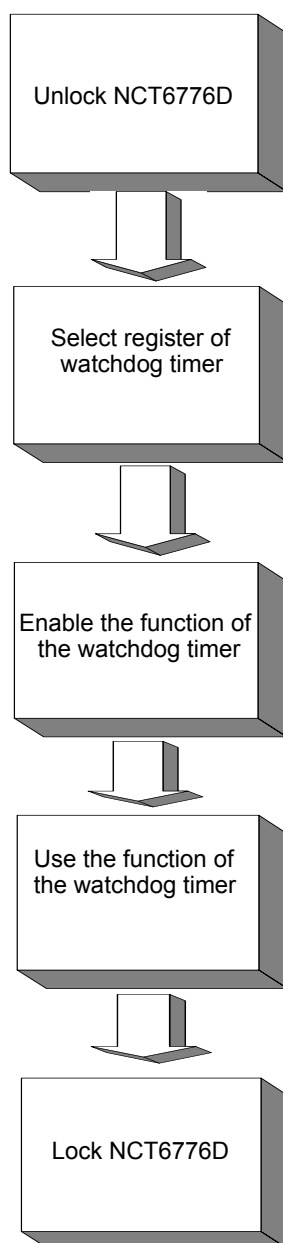
Table A.1: Watchdog timer registers

Address of register (2E)	Attribute Read/Write	Value (2F) & description
87 (hex)	-----	Write this address to I/O address port 2E (hex) twice to unlock the NCT6776D
07 (hex)	write	Write 08 (hex) to select register of watchdog timer.
30 (hex)	write	Write 01 (hex) to enable the function of the watchdog timer. Disabled is set as default.
F5 (hex)	write	Set seconds or minutes as units for the timer. Write 0 to bit 3: set second as counting unit. [default]. Write 1 to bit 3: set minutes as counting unit Write 1 to bit 4: Watchdog timer count mode is 1000 times faster. If bit 3 is 0, the count mode is 1/1000 seconds mode. If bit 3 is 1, the count mode is 1/1000 minutes mode.

F6 (hex)	write	0: stop timer [default] 01~FF (hex): The amount of the count, in seconds or minutes, depends on the value set in register F5 (hex). This number decides how long the watchdog timer waits for strobe before generating an interrupt or reset signal. Writing a new value to this register can reset the timer to count with the new value.
F7 (hex)	read/write	Bit 6: Write 1 to enable keyboard to reset the timer, 0 to disable.[default] Bit 5: Write 1 to generate a timeout signal immediately and automatically return to 0. [default=0] Bit 4: Read status of watchdog timer, 1 means timer is "timeout".
AA (hex)	-----	Write this address to I/O port 2E (hex) to lock the NCT6776D.

A.1.3 Example program

1. Enable watchdog timer and set 10 sec. as timeout interval

```

;-----
Mov dx,2eh          ; Unlock NCT6776D
Mov al,87h
Out dx,al
Out dx,al
;-----
Mov al,07h         ; Select registers of watchdog timer
Out dx,al
Inc dx
Mov al,08h
Out dx,al
;-----
Dec dx            ; Enable the function of watchdog timer
Mov al,30h
Out dx,al
Inc dx
In al,dx
Or al,01h
Out dx,al
;-----
Dec dx            ; Set second as counting unit
Mov al,0f5h
Out dx,al
Inc dx
In al,dx
And al,not 08h
Out dx,al
;-----
Dec dx            ; Set timeout interval as 10 seconds and start counting
Mov al,0f6h

```

```

Out    dx,al
Inc    dx
Mov    al,10      ; 10 seconds
Out    dx,al

```

```

;-----
Dec dx          ; Lock NCT6776D
Mov    al,0aah
Out    dx,al

```

2. Enable watchdog timer and set 5 minutes as timeout interval

```

;-----
Mov dx,2eh      ; Unlock NCT6776D
Mov al,87h
Out dx,al
Out dx,al

```

```

;-----
Mov al,07h      ; Select registers of watchdog timer
Out    dx,al
Inc    dx
In     al,dx
Or     al,08h
Out    dx,al

```

```

;-----
Dec dx          ; Enable the function of watchdog timer
Mov    al,30h
Out    dx,al
Inc    dx
Mov    al,01h
Out    dx,al

```

```

;-----
Dec dx          ; Set minute as counting unit
Mov    al,0f5h
Out    dx,al
Inc    dx
In     al,dx
Or     al,08h
Out    dx,al

```

```

;-----
Dec dx          ; Set timeout interval as 5 minutes and start counting
Mov    al,0f6h
Out    dx,al
Inc    dx
Mov    al,5      ; 5 minutes
Out    dx,al

```

```

;-----

```

```
Dec dx          ; Lock NCT6776D
Mov  al,0aah
Out  dx,al
```

3. Enable watchdog timer to be reset by mouse

```
-----
Mov dx,2eh      ; Unlock NCT6776D
Mov al,87h
Out dx,al
Out dx,al
-----
Mov al,07h      ; Select registers of watchdog timer
Out  dx,al
Inc  dx
Mov  al,08h
Out  dx,al
-----
Dec dx          ; Enable the function of watchdog timer
Mov  al,30h
Out  dx,al
Inc  dx
In   al,dx
Or   al,01h
Out  dx,al
```

```
-----
Dec dx          ; Enable watchdog timer to be reset by mouse
Mov  al,0f7h
Out  dx,al
Inc  dx
In   al,dx
Or  al,80h
Out  dx,al
```

```
-----
Dec dx          ; Lock NCT6776D
Mov  al,0aah
Out  dx,al
```

4. Enable watchdog timer to be reset by keyboard

```
-----
Mov dx,2eh      ; Unlock NCT6776D
Mov al,87h
Out dx,al
Out dx,al
-----
Mov al,07h      ; Select registers of watchdog timer
```

```

Out    dx,al
Inc    dx
Mov    al,08h
Out    dx,al
;-----
Dec dx          ; Enable the function of watchdog timer
Mov    al,30h
Out    dx,al
Inc    dx
Mov    al,01h
Out    dx,al
;-----
Dec dx          ; Enables watchdog timer to be strobe reset by keyboard
Mov    al,0f7h
Out    dx,al
Inc    dx
In     al,dx
Or    al,40h
Out    dx,al
;-----
Dec dx          ; Lock NCT6776D
Mov    al,0aah
Out    dx,al

5.   Generate a time-out signal without timer counting
;-----
Mov dx,2eh      ; Unlock NCT6776D
Mov al,87h
Out dx,al
Out dx,al
;-----
Mov al,07h      ; Select registers of watchdog timer
Out    dx,al
Inc    dx
Mov    al,08h
Out    dx,al
;-----
Dec dx          ; Enable the function of watchdog timer
Mov    al,30h
Out    dx,al
Inc    dx
Mov    al,01h
Out    dx,al
;-----
Dec dx          ; Generate a time-out signal

```

```
Mov    al,0f7h
Out    dx,al    ;Write 1 to bit 5 of F7 register
Inc    dx
In     al,dx
Or    al,20h
Out    dx,al
;-----
Dec dx    ; Lock NCT6776D
Mov    al,0aah
Out    dx,al
```

Appendix **B**

I/O Pin Assignments

B.1 Parallel Port Connector (LPT1)

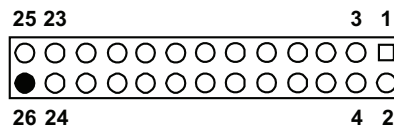

Table B.1: Parallel port connector (LPT1)

Pin	Signal	Pin	Signal
1	STROBE*	2	AUTOFD*
3	D0	4	ERR
5	D1	6	INIT*
7	D2	8	SLCTINI*
9	D3	10	GND
11	D4	12	GND
13	D5	14	GND
15	D6	16	GND
17	D7	18	GND
19	ACK*	20	GND
21	BUSY	22	GND
23	PE	24	GND
25	SLCT	26	N/C

* low active

B.2 VGA Connector (VGA1)

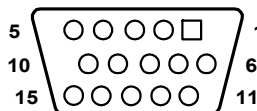

Table B.2: VGA connector (VGA1)

Pin	Signal	Pin	Signal
1	RED	9	VCC
2	GREEN	10	GND
3	BLUE	11	N/C
4	N/C	12	SDT
5	GND	13	H-SYNC
6	GND	14	V-SYNC
7	GND	15	SCK
8	GND		

B.3 RS 232 Serial Port (COM12)

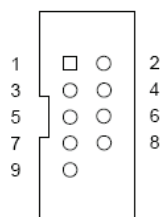

Table B.3: RS-232 serial port (COM2)

Pin	Signal
1	DCD
2	DSR
3	SIN
4	RTS
5	SOUT
6	CTS
7	DTR
8	RI
9	GND

B.4 USB 2.0 Header (USB56 & 910)

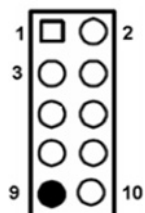

Table B.4: USB Header (USB56 & 910)

Pin	Signal	Pin	Signal
1	USB1_VCC5	6	USB2_D+
2	USB2_VCC5	7	GND
3	USB1_D-	8	GND
4	USB2_D-	9	Key
5	USB1_D+	10	NC

B.5 USB3.0 Header (USB12)

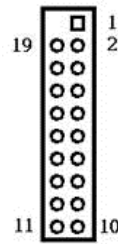

Table B.5: USB 3.0 Header (USB12)

Pin	Signal	Pin	Signal
1	USB1_VCC5	11	USB_P+_P2
2	USB3.0_RXN_P1	12	USB_P-_P2
3	USB3.0_RXP_P1	13	GND
4	GND	14	USB3.0_TXP_P2
5	USB3.0_TXN_P1	15	USB3.0_TXN_P2
6	USB3.0_TXP_P1	16	GND
7	GND	17	USB3.0_RXP_P2
8	USB_P-_P1	18	USB3.0_RXN_P2
9	USB_P+_P1	19	USB2_VCC5
10	Reserve		

B.6 PS/2 Keyboard/Mouse Connector (KBMS1)

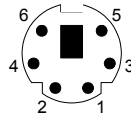

Table B.6: PS/2 keyboard/mouse connector (KBMS1)

Pin	Signal
1	KB DATA
2	MS DATA
3	GND
4	VCC
5	KB CLOCK
6	MS CLOCK

B.7 External Keyboard Connector (KBMS2)

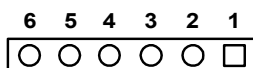

Table B.7: External keyboard connector (KBMS2)

Pin	Signal
1	KBCLK
2	KBDAT
3	MSDAT
4	GND
5	MSVCC
6	MSCLK

B.8 CPU Fan Power Connector (CPUFAN1)

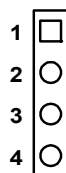

Table B.8: CPU fan power connector (CPUFAN1)

Pin	Signal
1	GND
2	+12V
3	Detect
4	NC

B.9 Power LED and Keyboard Lock Connector (JFP3 / PWR_LED & KEY LOCK)

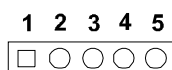

Table B.9: Power LED and keyboard lock connector (JFP3 / PWR_LED & KEY LOCK)

Pin	Signal
1	LED power (+3.3 V)
2	NC
3	GND
4	KEYLOCK#
5	GND

B.10 External Speaker Connector (JFP2 / SPEAKER)

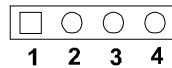

Table B.10: External speaker connector (JFP2 / SPEAKER)

Pin	Signal
1	SPK_CN17P1
2	SPK_CN17P2
3	SPK_CN17P3
4	SPK_CN17P4

B.11 Reset Connector (JFP1 / RESET)

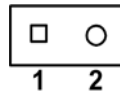

Table B.11: Reset connector (JFP1 / RESET)

Pin	Signal
1	RESET #
2	GND

B.12 HDD LED (JFP2 / HDDLED)

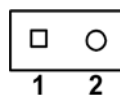

Table B.12: HDD LED (JFP2 / HDDLED)

Pin	Signal
1	HDD LED
2	SATA LED

B.13 ATX Soft Power Switch (JFP1 / PWR_SW)

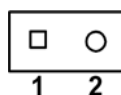

Table B.13: ATX soft power switch (JFP1 / PWR_SW)

Pin	Signal
1	3.3 VSB
2	PWR-BTN

B.14 Hi-definition Audio Link Connector (HDAUD1)

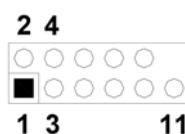

Table B.14: Hi-definition audio link connector (HDAUD1)

Pin	Signal	Pin	Signal
1	ACZ_VCC	2	GND
3	ACZ_SYNC	4	ACZ_BITCLK
5	ACZ_SDOOUT	6	ACZ_SDIN0
7	ACZ_SDIN1	8	-ACZ_RST
9	ACZ_12V	10	GND
11	GND	12	N/C

B.15 SM Bus Connector (JFP2 / SNMP)

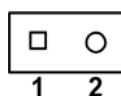

Table B.15: SM bus connector (JFP2 / SNMP)

Pin	Signal
1	SMB_DATA
2	SMB_CLK

B.16 LAN1 and LAN2 LED Connector (LANLED1)

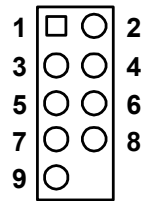

Table B.16: LAN1 and LAN2 LED connector (LANLED1)

Pin	Signal
1	#LAN1_ACT
2	#LAN2_ACT
3	V33_AUX
4	V33_AUX
5	#LAN1_LINK1000
6	#LAN2_LINK1000
7	#LAN1_LINK100
8	#LAN2_LINK100
9	V33_AUX

B.17 GPIO Header (GPIO1)

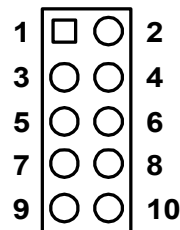

Table B.17: GPIO header (GPIO1)

Pin	Signal
1	SIO_GPIO0
2	SIO_GPIO4
3	SIO_GPIO1
4	SIO_GPIO5
5	SIO_GPIO2
6	SIO_GPIO6
7	SIO_GPIO3
8	SIO_GPIO7
9	VCC_GPIO
10	GND

B.18 Fixed I/O Ranges Decoded by Intel PCH

Table B.18: Fixed I/O Ranges Decoded by PCH			
I/O Address	Read Target	Write Target	Internal Unit
00h–1Fh	RESERVED	RESERVED	Not Decoded
20h–21h	Interrupt Controller	Interrupt Controller	Interrupt
24h–25h	Interrupt Controller	Interrupt Controller	Interrupt
28h–29h	Interrupt Controller	Interrupt Controller	Interrupt
2Ch–2Dh	Interrupt Controller	Interrupt Controller	Interrupt
2Eh–2Fh	LPC SIO	LPC SIO	Forwarded to LPC
30h–31h	Interrupt Controller	Interrupt Controller	Interrupt
34h–35h	Interrupt Controller	Interrupt Controller	Interrupt
38h–39h	Interrupt Controller	Interrupt Controller	Interrupt
3Ch–3Dh	Interrupt Controller	Interrupt Controller	Interrupt
40h–42h	Timer/Counter	Timer/Counter	PIT (8254)
43h	RESERVED	Timer/Counter	PIT
4Eh–4Fh	LPC SIO	LPC SIO	Forwarded to LPC
50h–52h	Timer/Counter	Timer/Counter	PIT
53h	RESERVED	Timer/Counter	PIT
60h	Microcontroller	Microcontroller	Forwarded to LPC
61h	NMI Controller	NMI Controller	Processor I/F
62h	Microcontroller	Microcontroller	Forwarded to LPC
63h	NMI Controller	NMI Controller	Processor I/F
64h	Microcontroller	Microcontroller	Forwarded to LPC
65h	NMI Controller	NMI Controller	Processor I/F
66h	Microcontroller	Microcontroller	Forwarded to LPC
67h	NMI Controller	NMI Controller	Processor I/F
70h	RESERVED1	NMI and RTC Controller	RTC
71h	RTC Controller	RTC Controller	RTC
72h	RTC Controller	NMI and RTC Controller	RTC
73h	RTC Controller	RTC Controller	RTC
74h	RTC Controller	NMI and RTC Controller	RTC
75h	RTC Controller	RTC Controller	RTC
76h	RTC Controller	NMI and RTC Controller	RTC
77h	RTC Controller	RTC Controller	RTC
80h	LPC or PCIe2	LPC or PCIe2	Forwarded to LPC or PCIe
81h–83h	RESERVED	RESERVED	Not Decoded
84h–86h	RESERVED	LPC or PCIe	Forwarded to LPC or PCIe
87h	RESERVED	RESERVED	Not Decoded
88h	RESERVED	LPC or PCIe2	Forwarded to LPC or PCIe
89h–8Bh	RESERVED	RESERVED	Not Decoded
8Ch–8Eh	RESERVED	LPC or PCIe2	Forwarded to LPC or PCIe
8Fh	RESERVED	RESERVED	Not Decoded
90h	Alias to 80h	Alias to 80h	Forwarded to LPC

91h	RESERVED	RESERVED	Not Decoded
92h	Reset Generator	Reset Generator	Processor I/F
93h–9Fh	RESERVED	RESERVED	Forwarded to LPC
A0h–A1h	Interrupt Controller	Interrupt Controller	Interrupt
A4h–A5h	Interrupt Controller	Interrupt Controller	Interrupt
A8h–A9h	Interrupt Controller	Interrupt Controller	Interrupt
ACh–ADh	Interrupt Controller	Interrupt Controller	Interrupt
B0h–B1h	Interrupt Controller	Interrupt Controller	Interrupt
B2h–B3h	Power Management	Power Management	Power Management
B4h–B5h	Interrupt Controller	Interrupt Controller	Interrupt
B8h–B9h	Interrupt Controller	Interrupt Controller	Interrupt
BCh–BDh	Interrupt Controller	Interrupt Controller	Interrupt
C0h–DFh	RESERVED	RESERVED	Not Decoded
F0h	FERR# / Interrupt Controller	FERR# / Interrupt Controller	Processor I/F
170h–177h	SATA Controller, PCI, or PCIe	SATA Controller, PCI, or PCIe	SATA
1F0h–1F7h	SATA Controller, PCI, or PCIe	SATA Controller, PCI, or PCIe	SATA
200h–207h	Gameport Low	Gameport Low	Forwarded to LPC
208h–20Fh	Gameport High	Gameport High	Forwarded to LPC
376h	SATA Controller, PCI, or PCIe	SATA Controller, PCI, or PCIe	SATA
3F6h	SATA Controller, PCI, or PCIe	SATA Controller, PCI, or PCIe	SATA
4D0h–4D1h	Interrupt Controller	Interrupt Controller	Interrupt
CF9h	Reset Generator	Reset Generator	Processor I/F

B.19 System I/O Ports

Table B.19: System I/O Ports

I/O Address (Hex)	Device
290h–29Fh	H/W Monitor
2F8h–2FFh	Communication Port (COM2)
378h–37Fh	ECP Printer Port(LPT1)
3B0h–3BBh	Graphics
3C0h–3DFh	Graphics
3F8h–3FFh	Communication Port (COM1)
400h–47Fh	PMBASE
500h–57Fh	GPIOBASE
600h–67Fh	PCA-COM485 Module I/O used
778h–77Fh	ECP Printer Port(LPT1)
C80h–C9Fh	Communication port (COM3-6) for PCA-COM232 module
CA0h–CBFh	Communication port (COM8-11) for PCA-COM485 module

B.20 Interrupt Assignments

Table B.20: Interrupt Assignments

Interrupt#	Interrupt source
IRQ0	System timer
IRQ1	Keyboard
IRQ2	Interrupt from controller 2 (cascade)
IRQ3	Communication port (COM2)
IRQ4	Communication port (COM1)
IRQ5	Available
IRQ6	Communication port (COM8-11) for PCA-COM485 module
IRQ7	Available
IRQ8	System COMS/Real-time clock
IRQ9	Available
IRQ10	Intel 8/C220 series SMBus Controller
IRQ11	Communication port (COM3-6) for PCA-COM232 module
IRQ12	PS/2 mouse
IRQ13	Numeric data processor
IRQ14	Available
IRQ15	Available

B.21 1 MB Memory Map

Table B.21: 1 MB memory map

Address Range	Device
E8000h - FFFFFh	BIOS
D0000h - E7F00	Unused
C0000h - CFF00	VGA BIOS
A0000h - BFFFFh	Video Memory
00000h - 9FFFFh	Base memory

B.22 PCI Bus Map

Table B.22: PCI Bus Map

Signal	IDSEL	INT#PIN	GNT	REQ
PCI Slot 1	AD31	INT B, C, D, A	GNT A	REQ A
PCI Slot 2	AD30	INT C, D, A, B	GNT B	REQ B
PCI Slot 3	AD29	INT D, A, B, C	GNT C	REQ C
PCI Slot 4	AD28	INT A, B, C, D	GNT D	REQ D

Appendix **C**

Programming the
GPIO

C.1 Supported GPIO Register

Below are the detailed descriptions of the GPIO addresses and a programming sample.

C.2 GPIO Registers

Bank	Offset	Description
09h	30h	Write 1 to bit 7 to enable GPIO
07h	E0h	GPIO I/O Register When set to a '1', respective GPIO port is programmed as an input port. When set to a '0', respective GPIO port is programmed as an output port.
07h	E1h	GPIO Data Register If a port is programmed to be an output port, then its respective bit can be read/written. If a port is programmed to be an input port, then its respective bit can only be read.
07h	E2h	GPIO Inversion Register When set to a '1', the incoming/outgoing port value is inverted. When set to a '0', the incoming/outgoing port value is the same as in data register.

C.3 GPIO Example Program-1

Enter the extended function mode, interruptible double-write

```
MOV DX,2EH  
MOV AL,87H  
OUT DX,AL  
OUT DX,AL
```

Configure logical device, configuration register CRE0,CRE1,CRE2

```
MOV DX,2EH  
MOV AL,09H  
OUT DX,AC  
DEC DX  
MOV AL,30H  
OUT DX,AL  
INC DX  
IN AL,DX  
OR AL,10000000B  
DEC DX  
MOV AL,07H  
OUT DX,AL
```

```
INC DX
MOV AL,07H ; Select logical device 7
OUT DX,AL ;
DEC DX
MOV AL,E0H
OUT DX,AL
INC DX
MOV AL,00H ; 1:Input 0:output for GPIO respective
OUT DX,AL
DEC DX
MOV AL,E2H ;
OUT DX,AL
INC DX
MOV AL,00H ;Set GPIO is normal not inverter
OUT DX,AL;
DEC DX
MOV AL,E1H
OUT DX,AL
INC DX
MOV AL,??H ; Put the output value into AL
OUT DX,AL

-----
Exit extended function mode |
-----

MOV DX,2EH
MOV AL,AAH
OUT DX,AL
```

ADVANTECH

Enabling an Intelligent Planet

www.advantech.com

Please verify specifications before quoting. This guide is intended for reference purposes only.

All product specifications are subject to change without notice.

No part of this publication may be reproduced in any form or by any means, electronic, photocopying, recording or otherwise, without prior written permission of the publisher.

All brand and product names are trademarks or registered trademarks of their respective companies.

© Advantech Co., Ltd. 2014