

# Bridgetek Pte Ltd MM932LC Development Module Datasheet

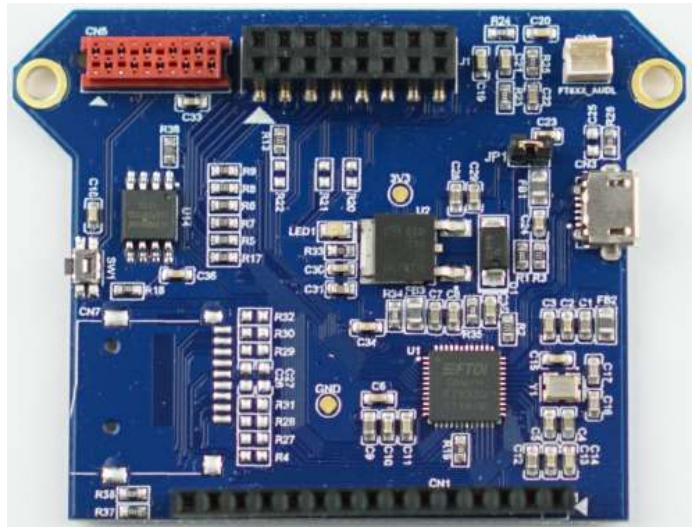

*FT93x Family is a General Purpose 32-bit Microcontroller*

## 1 Introduction

The MM932LC is a low cost development module for Bridgetek's 32-bit high performance FT93x Microcontroller family, which is used to develop and demonstrate the functionality of the FT932 Embedded Microcontroller.

This module is ideal for simple applications including USB capability products, embedded multimedia applications and other industrial control systems.

## 1.1 Features

For a full list of the FT93x features refer to the [FT93x datasheet](#). In addition, the MM932LC module has the following features:

- FT932Q 48-pin QFN package microcontroller.
- In built 16M Byte Eflash memory.
- A Micro-B USB connector for connecting to a USB host or providing a power supply over USB for the board.
- 2x8 pins 2.54mm pitch dual entry female header for SPI master to support LCD display modules.
- 2x5 pins 1.27mm pitch female Micro-MaTch connector for software download.
- 1x15 pins 2.54mm pitch female header support for external feature expansions.
- Hardware Reset button provided.

Neither the whole nor any part of the information contained in, or the product described in this manual, may be adapted or reproduced in any material or electronic form without the prior written consent of the copyright holder. This product and its documentation are supplied on an as-is basis and no warranty as to their suitability for any particular purpose is either made or implied. Bridgetek Pte Ltd will not accept any claim for damages howsoever arising as a result of use or failure of this product. Your statutory rights are not affected. This product or any variant of it is not intended for use in any medical appliance, device or system in which the failure of the product might reasonably be expected to result in personal injury. This document provides preliminary information that may be subject to change without notice. No freedom to use patents or other intellectual property rights is implied by the publication of this document. Bridgetek Pte Ltd, 178 Paya Lebar Road, #07-03, Singapore 409030. Singapore Registered Company Number: 201542387H

## 2 Ordering Information

Part No.	Description
<b>MM932LC</b>	FT932 module, a 32-bit microcontroller with 128kB flash memory, 32kB data RAM and 128kB program memory embedded. USB2.0 Device, 16MB Eflash, several interface pin headers and connectors included.

**Table 2-1 – Ordering information**

### 3 Program Support

Example applications are provided for the MM932LC module by Bridgetek.

For other relevant documents and examples, please refer to the [Bridgetek website](#).

Refer to [BRT\\_AN\\_010\\_FT93x\\_User\\_Manual](#) for system register information.

## **Table of Contents**

<b>1</b>	<b>Introduction .....</b>	<b>1</b>
1.1	<b>Features.....</b>	<b>1</b>
<b>2</b>	<b>Ordering Information .....</b>	<b>2</b>
<b>3</b>	<b>Program Support.....</b>	<b>3</b>
<b>4</b>	<b>Board Layout.....</b>	<b>5</b>
4.1	<b>Power Supply .....</b>	<b>6</b>
4.2	<b>Microcontroller.....</b>	<b>6</b>
4.3	<b>Flash Memory.....</b>	<b>7</b>
4.4	<b>USB Connector .....</b>	<b>8</b>
4.5	<b>Programmer Interface .....</b>	<b>8</b>
4.5.1	CN5 – 10-pin Micro-Match Program Interface Signals .....	8
4.6	<b>SPI Master Interface.....</b>	<b>9</b>
4.6.1	J1 – 16-pin Dual Entry Header, SPI Master and Control Signals .....	10
4.7	<b>External I/O Bus.....</b>	<b>11</b>
4.7.1	CN1 – 15-pin Single Header, Multiple Interface Signals .....	11
<b>5</b>	<b>Board Schematic .....</b>	<b>14</b>
<b>6</b>	<b>Mechanical Dimensions .....</b>	<b>16</b>
6.1	<b>MM932LC PCB Dimensions .....</b>	<b>16</b>
<b>7</b>	<b>Contact Information.....</b>	<b>17</b>
<b>Appendix A - References .....</b>		<b>19</b>
<b>Document References .....</b>		<b>19</b>
<b>Acronyms and Abbreviations.....</b>		<b>19</b>
<b>Appendix B - List of Figures and Tables .....</b>		<b>20</b>
<b>List of Figures .....</b>		<b>20</b>
<b>List of Tables.....</b>		<b>20</b>
<b>Appendix C – Revision History .....</b>		<b>21</b>

## 4 Board Layout

The MM932LC development board is a 55 mm x 51 mm (Not including the 2 mounting holes) two-layer printed circuit board. The layout is as shown in Figure 4-1.

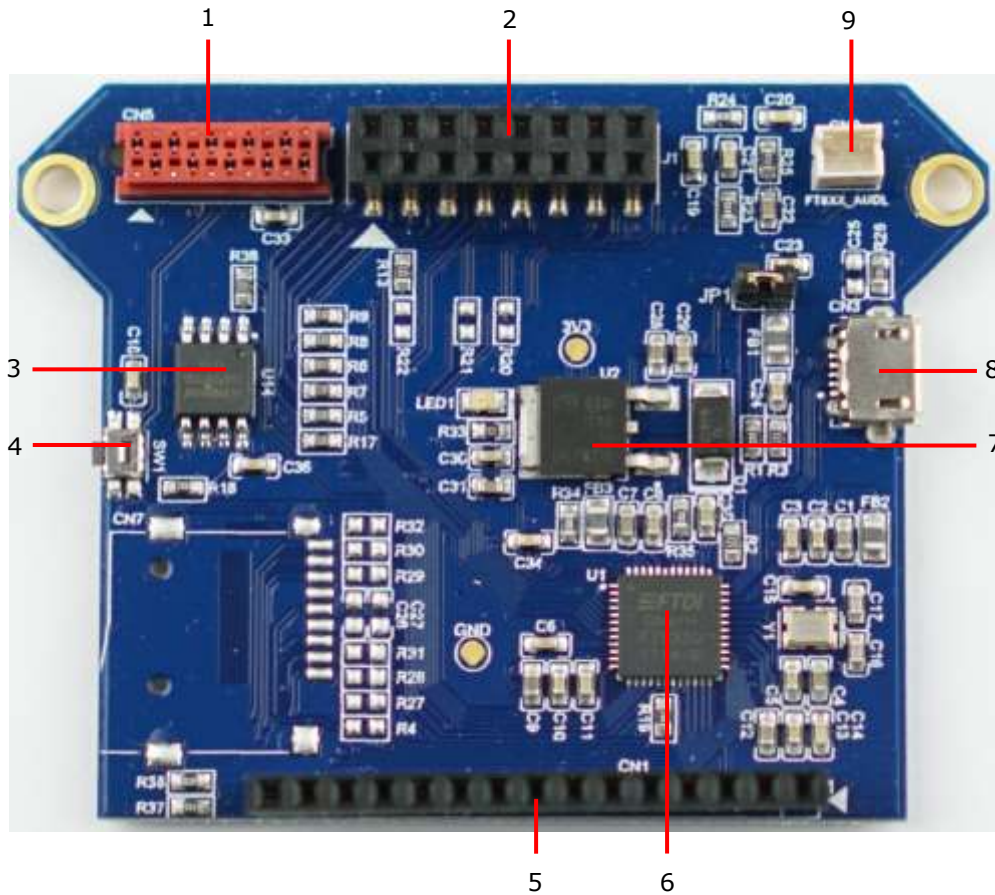

**Figure 4-1 – MM932LC Board Layout**

Key Features:

- |                                       |  |
|---------------------------------------|--|
| 1. Micro-MaTch connector              | 6. FT932Q QFN48 Microcontroller                                      |
| 2. Dual-entry female header           | 7. LDO regulator   |
| 3. 16M Byte Eflash memory             | 8. USB Micro-B connector   |
| 4. H/W Reset button                   | 9. Audio PWM output from FT8xx (assumes FT8xx based LCD plugged in). |
| 5. External I/O bus female pin header |  |

## 4.1 Power Supply

The MM932LC development board is powered from a USB power supply source via the Micro-B USB **CN3** port. A power jumper **JP1** connects the USB power (VBUS\_IN) to the input of an LDO regulator (VDD\_5V).

A red LED (LED1) will illuminate after the +5V power supply is applied. This supply will also drive a fixed +3.3V LDO regulator which will provide power to all peripherals of the FT932 microcontroller.

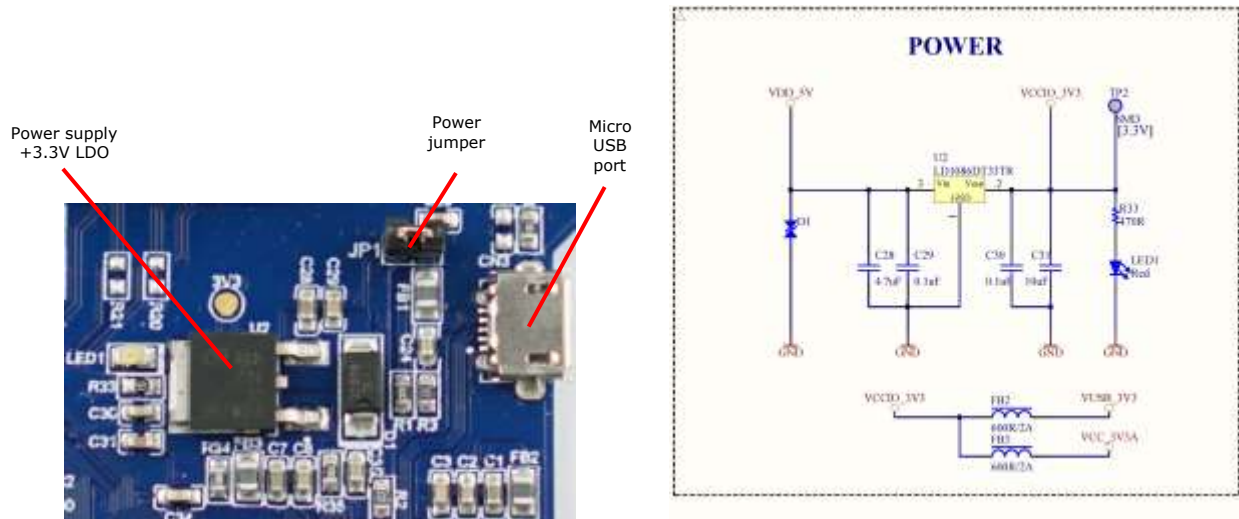

**Figure 4-2 – Power supply**

## 4.2 Microcontroller

The FT932Q 48-pin QFN microcontroller (U1) provided on the board belongs to the 32-bit FT93x Microcontroller family from Bridgetek. For details of the FT932 Microcontroller, refer to the [FT93x datasheet](#).

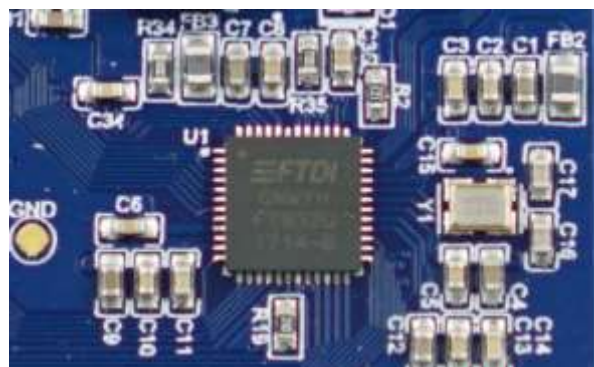

**Figure 4-3 – FT932 Microcontroller**

There is one crystal used on the MM932LC development board. The 12MHz crystal (Y1) is the primary system clock frequency supplying the FT932Q IC.

The FT932Q IC on this board is operated from a single supply of +3.3V. The power output pins have decoupling capacitors as specified in the datasheet.

### 4.3 Flash Memory

The MM932LC module contains an on-board Winbond Serial Flash memory W25Q128FV (128M-bit/16Mbyte) with Dual/Quad SPI interface, which is ideal for code shadowing and storing voice, text and data.

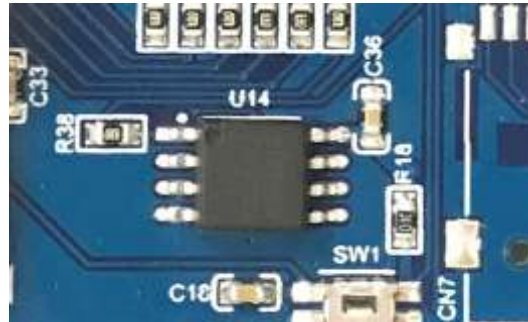

**Figure 4-4 – Flash Memory**

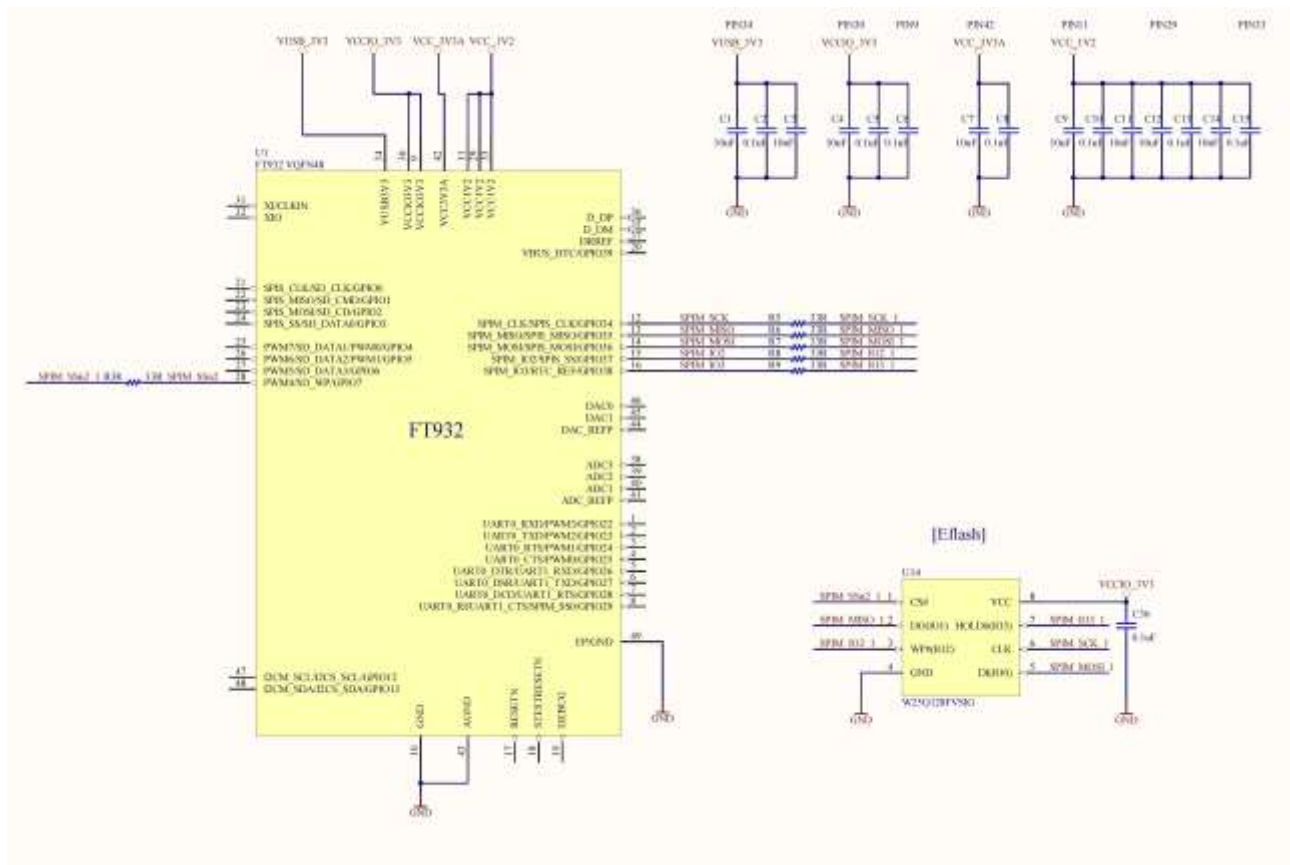

**Figure 4-5 – Flash Memory Interface**

## 4.4 USB Connector

There is a USB connector provided on the MM932LC board. **CN3** is a Micro-B type USB2.0 connector which is used for connecting the module to a USB host. This is for power and data transfer.

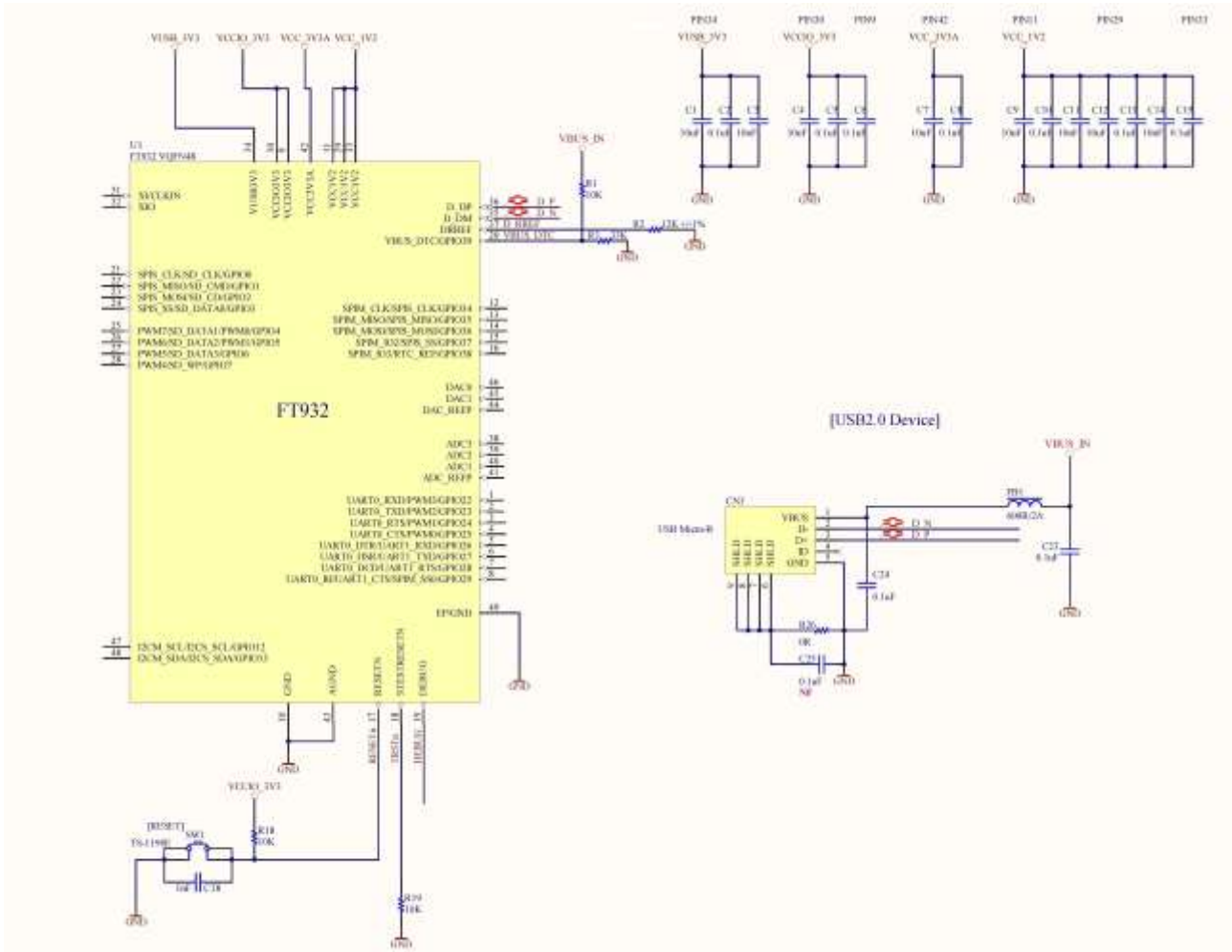

Figure 4-6 – USB Connectors Interface

## 4.5 Programmer Interface

The programmer interface **CN5**, 2x5 pins 1.27mm pitch female Micro-Match header supports software application download, GDB debugging on the MM932LC development board with the [UMFTPD2A module](#).

### 4.5.1 CN5 – 10-pin Micro-Match Program Interface Signals

Pin No.	Name	Type	Description
1~6	-	-	-
7	GND	P	Ground
8	DEBUG	I/O	FT90x One-Wire Interface



Pin No.	Name	Type	Description
9	GDB_5V	P	External 5V power supply
10	RESETn	P	H/W Reset, active low

**Table 4-1 – CN5 Pinout**

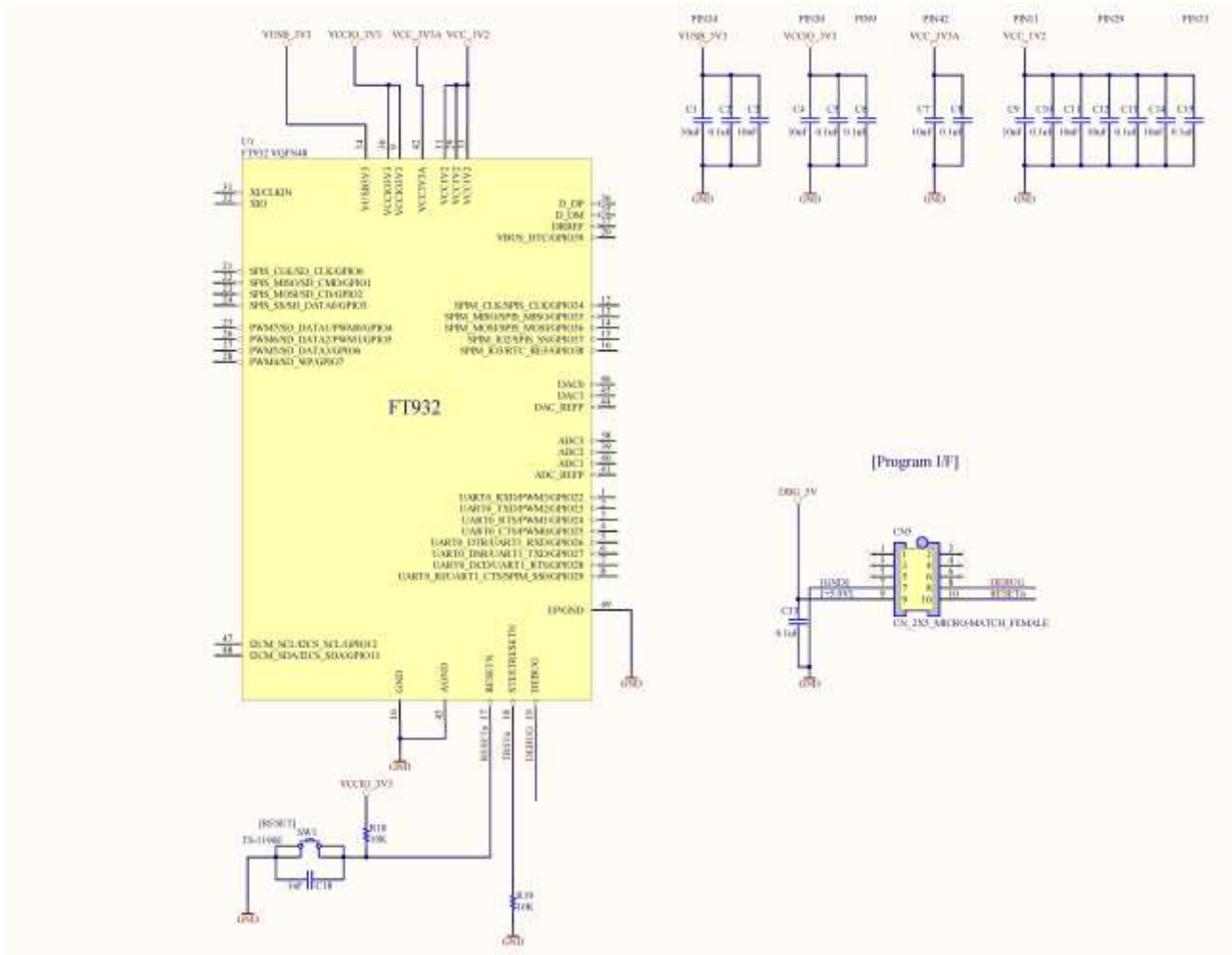

**Figure 4-7 – Programmer Interface**

## 4.6 SPI Master Interface

The FT932Q microcontroller has a SPI master interface that supports single, dual and quad SPI data transfer modes. There is a connector for supporting different [FT8xx](#) enabled LCD display modules as SPI slave devices.

- The **J1** dual-entry 2x8 pins 2.54mm pitch, female header is designed for FT80x and FT81x Embedded Video Engine (EVE) family LCD display modules. For example the [ME810A-HV35R module](#), can connect directly to the MM932LC development board on the bottom side with a male pin header.

#### 4.6.1 J1 – 16-pin Dual Entry Header, SPI Master and Control Signals

Pin No.	Name	Type	Description
1	SPIM_SCK	O	SPI Master clock output
2	SPIM_SS <sub>n</sub> 0	O	SPI Master chip select 0, active low
3	SPIM_MISO	I/O	SPI Master input, Slave output Data 1 for Quad SPI
4	SPIM_MOSI	I/O	SPI Master output, Slave input Data 0 for Quad SPI
5	SPIM_IO3	I/O	General I/O, data 3 for Quad SPI
6	SPIM_IO2	I/O	General I/O, data 2 for Quad SPI
7	DCX	O	Data / command selection pin for LCD controller Low: Command High: Parameter
8	CS1#	O	SPI Master chip select 1, active low for LCD controller
9	VCCIO_3V3	P	+3.3V power supply
10	VDD_5V	P	+5V power supply
11	GND	P	Ground
12	GND	P	Ground
13	PWD#	O	FT8XX power down control, active low
14	INT#	I	Interrupt input from FT8XX, active low
15	AUD_LIN	I	Audio PWM output from FT8XX
16	DISP	O	LCD display enable

**Table 4-2 – J1 Pinout**

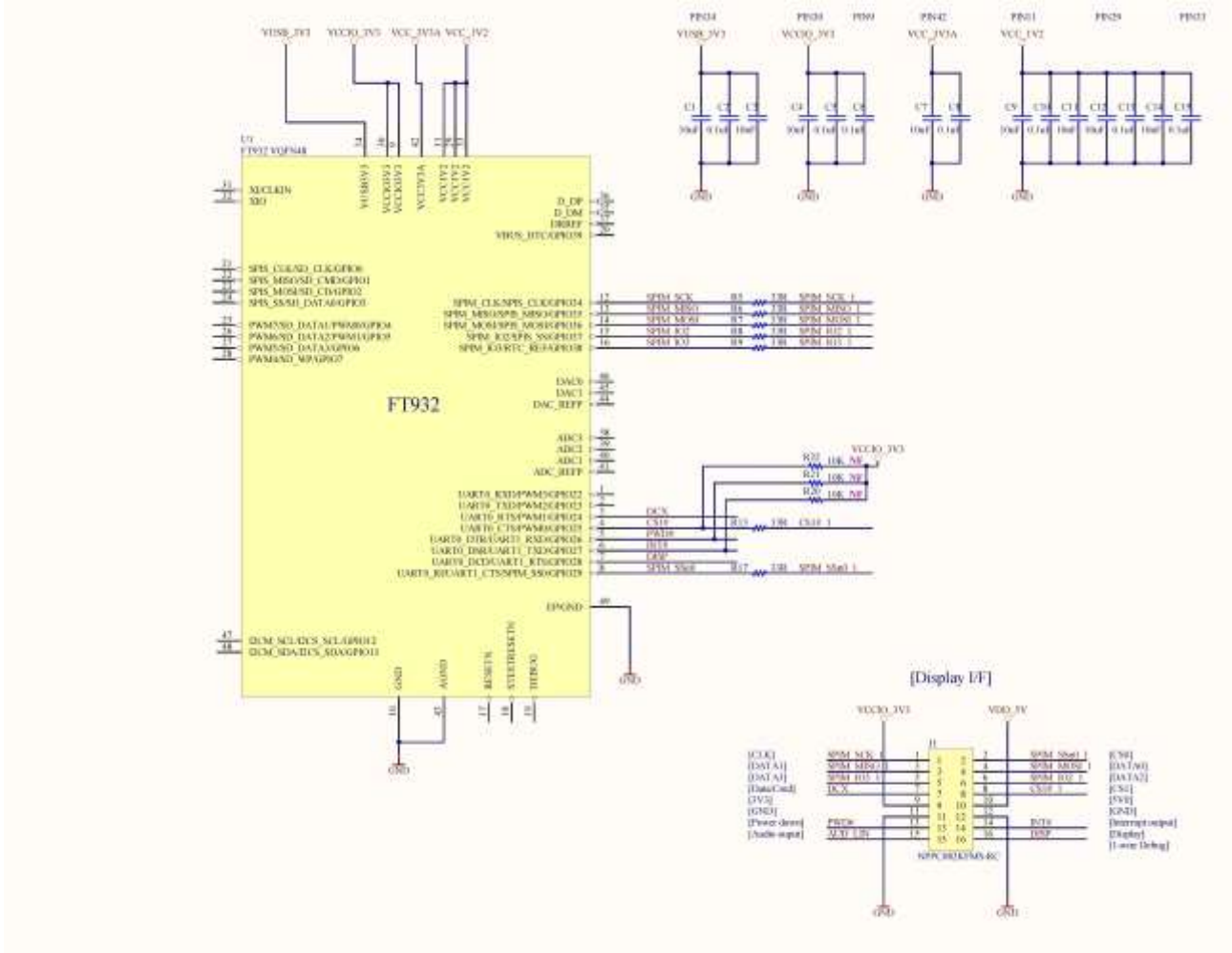

**Figure 4-8 – SPI Master Interface**

## 4.7 External I/O Bus

There are multiple interface signals provided on **CN1** 1x15 pins, 2.54mm pitch female header. External feature boards may connect via UART, PWM, ADC, DAC and I2C on these IO connectors.

Table 4-3 lists all features assigned for each pin.

### 4.7.1 CN1 – 15-pin Single Header, Multiple Interface Signals

Pin No.	Function 1	Function 2	Function 3	Description
1	VDD_5V	-	-	+5.0V supply voltage, output.
2	VCCIO_3V3	-	-	+3.3V supply voltage, output.
3	ADC1	-	-	8-bit Analog-to-Digital converter 1, input.
4	ADC2	-	-	8-bit Analog-to-Digital converter 2, input.
5	ADC3	-	-	8-bit Analog-to-Digital converter 3, input.

Pin No.	Function 1	Function 2	Function 3	Description
6,9,12,15	GND	-	-	Ground.
7	DAC0	-	-	10-bit Digital-to-Analog converter 0, output.
8	DAC1	-	-	10-bit Digital-to-Analog converter 1, output.
10	I2CM_SDA	I2CS_SDA	GPIO13	I2C master data line input/output. I2C slave data line input/output. GPIO13 input/output.
11	I2CM_SCL	I2CS_SCL	GPIO12	I2C master serial clock input/output. I2C slave serial clock input/output. GPIO12 input/output.
13	UART0_RXD	PWM3	GPIO22	UART0 receiver input. PWM channel 3, output. GPIO22 input/output.
14	UART0_TXD	PWM2	GPIO23	UART0 transmitter output. PWM channel 2, output. GPIO23 input/output.

**Table 4-3 – CN1 External I/O Bus**

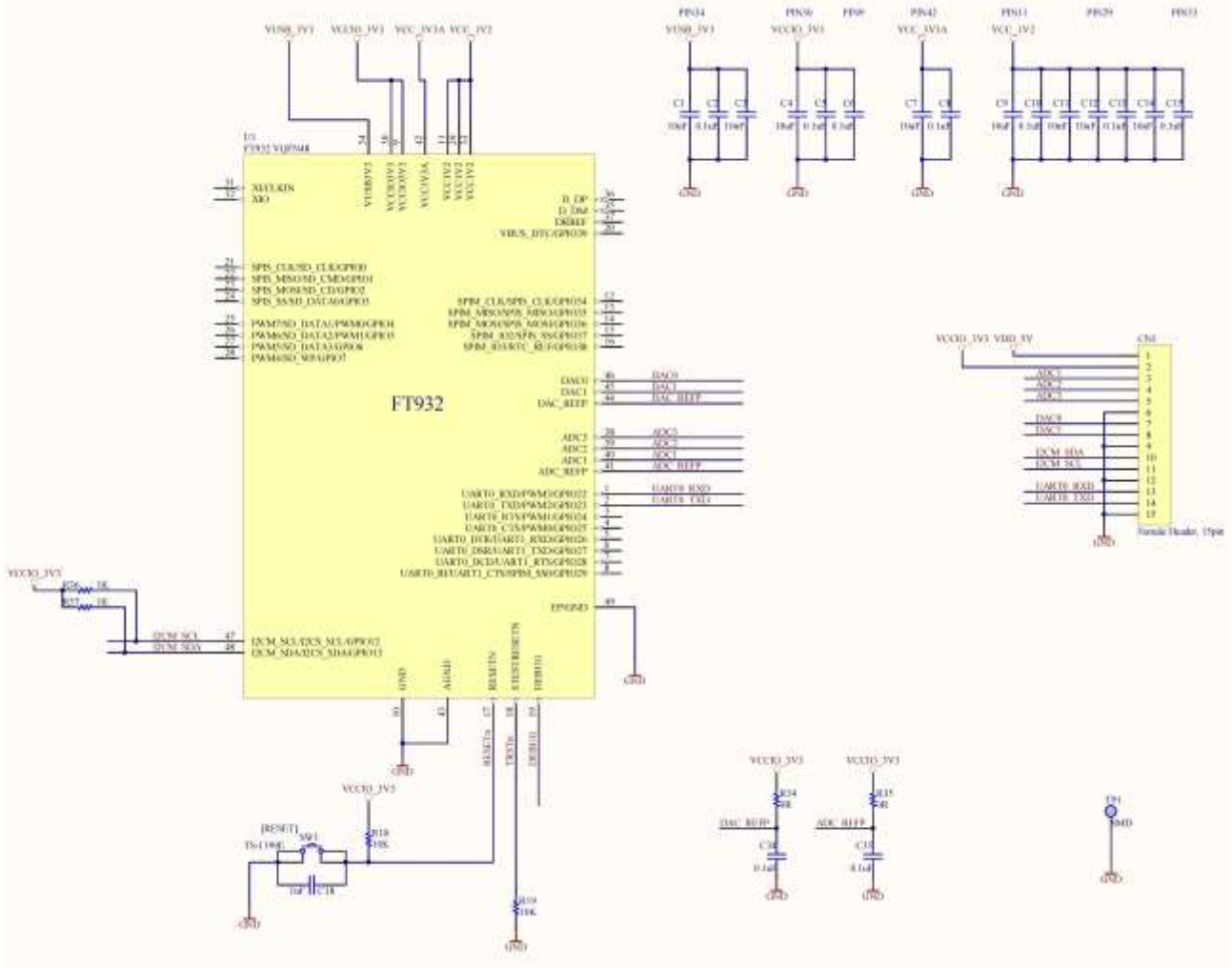

**Figure 4-9 – External I/O Bus**

## 5 Board Schematic

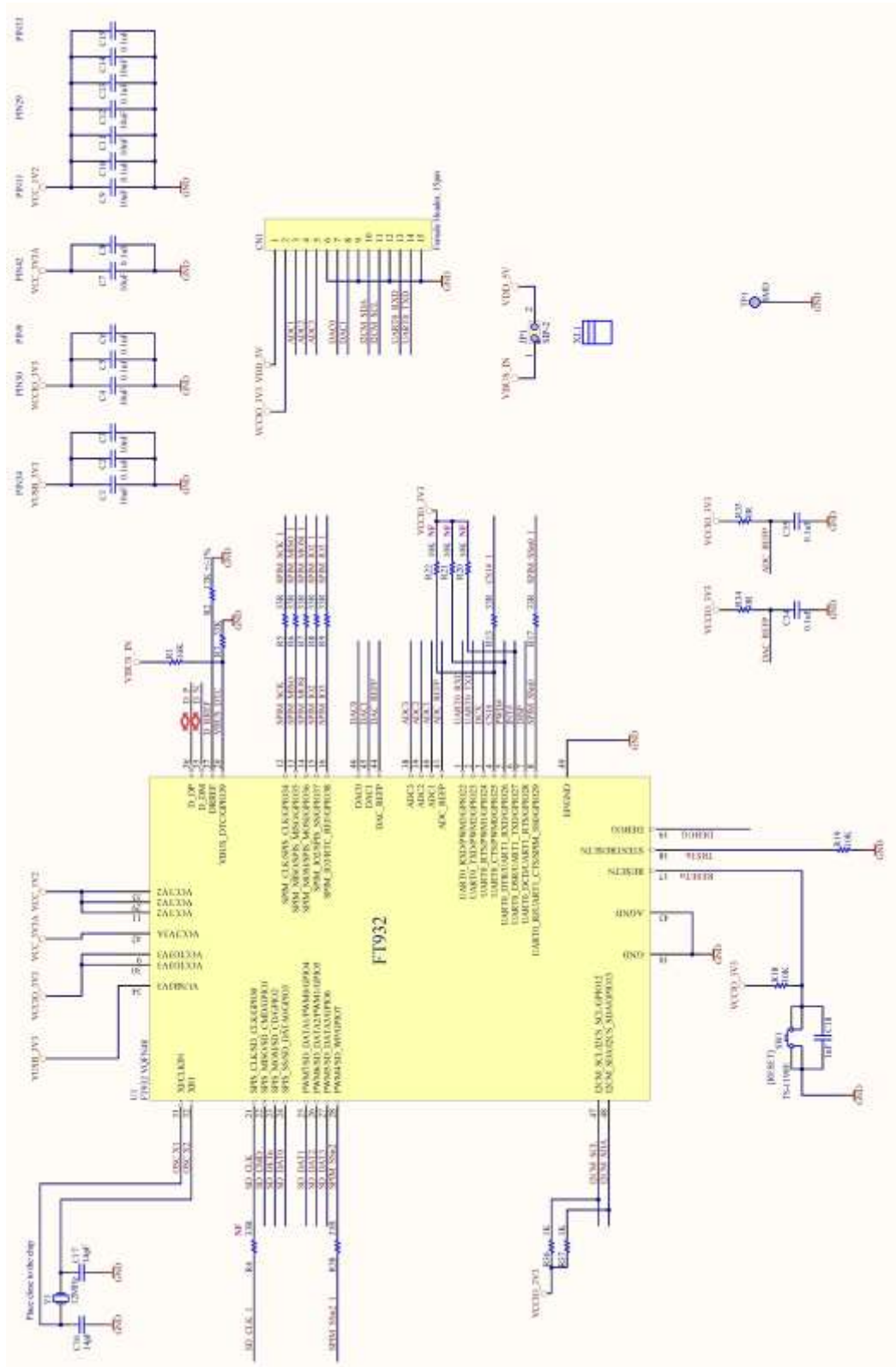

**Figure 5-1 – MM932LC MCU and External I/O Bus**

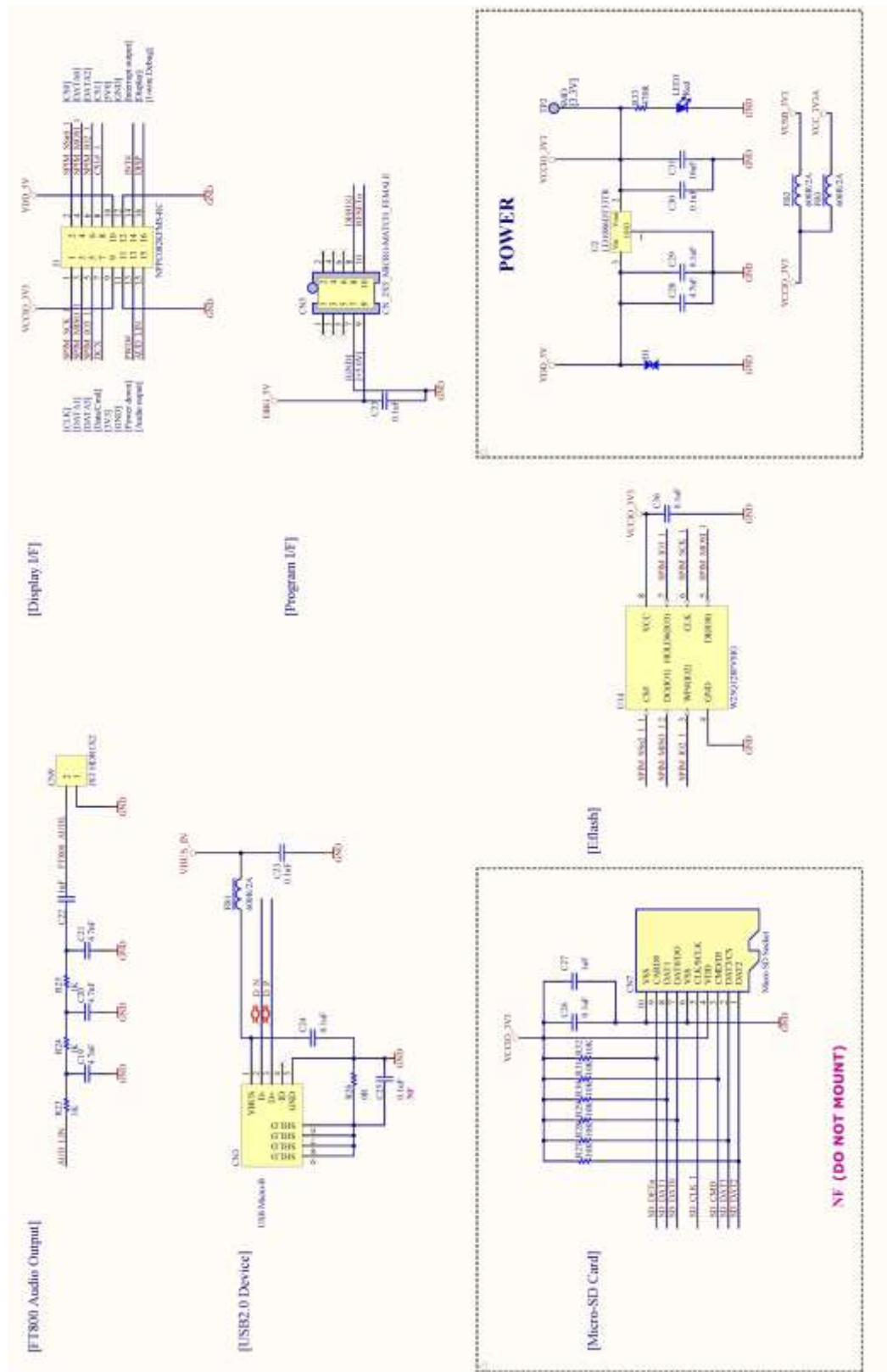
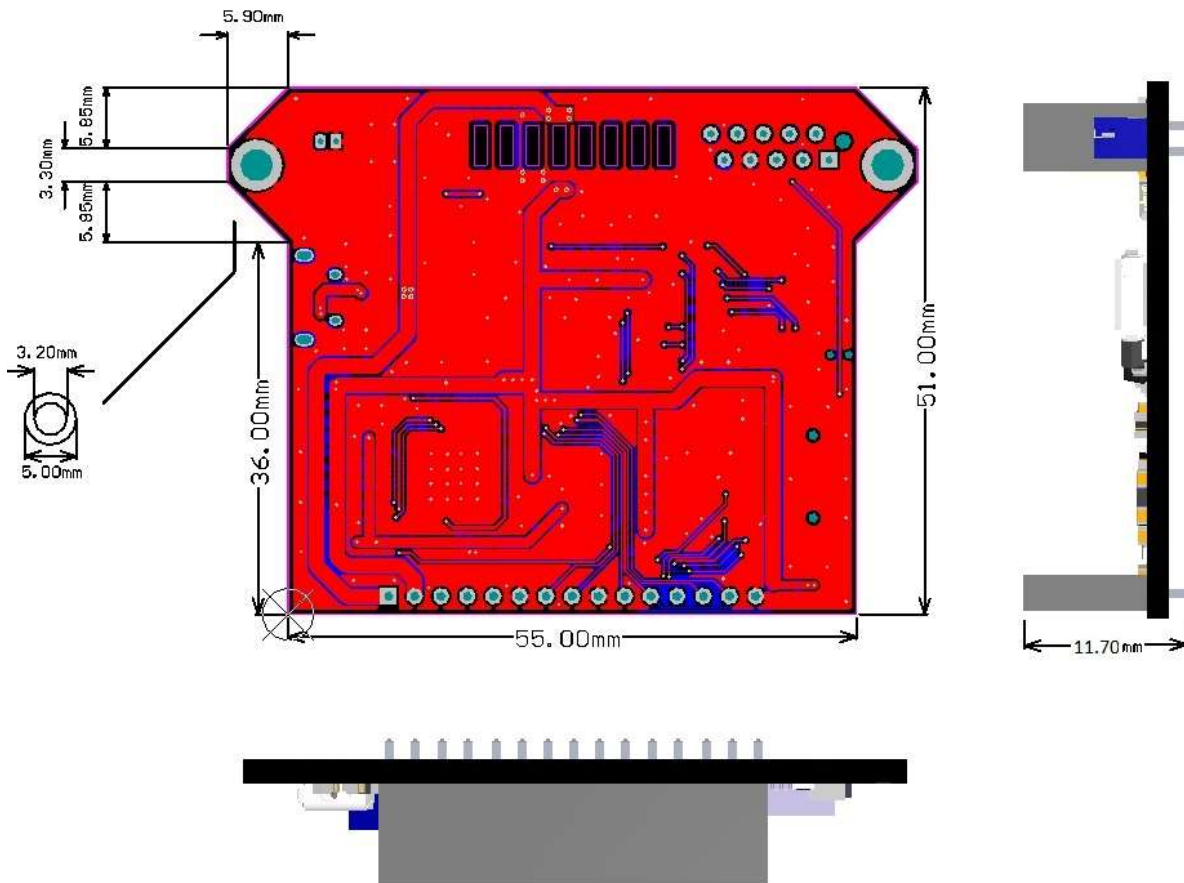

Figure 5-2 – MM932LC Interfaces and Connectors

## 6 Mechanical Dimensions

### 6.1 MM932LC PCB Dimensions



**Figure 6-1 – MM932LC PCB Dimensions**



## 7 Contact Information

### Head Quarters – Singapore

Bridgetek Pte Ltd  
178 Paya Lebar Road, #07-03  
Singapore 409030  
Tel: +65 6547 4827  
Fax: +65 6841 6071

E-mail (Sales) [sales.apac@brtchip.com](mailto:sales.apac@brtchip.com)  
E-mail (Support) [support.apac@brtchip.com](mailto:support.apac@brtchip.com)

### Branch Office - Glasgow, United Kingdom

Bridgetek Pte. Ltd.  
Unit 1, 2 Seaward Place, Centurion Business Park  
Glasgow G41 1HH  
United Kingdom  
Tel: +44 (0) 141 429 2777  
Fax: +44 (0) 141 429 2758

E-mail (Sales) [sales.emea@brtchip.com](mailto:sales.emea@brtchip.com)  
E-mail (Support) [support.emea@brtchip.com](mailto:support.emea@brtchip.com)

### Branch Office – Taipei, Taiwan

Bridgetek Pte Ltd, Taiwan Branch  
2 Floor, No. 516, Sec. 1, Nei Hu Road, Nei Hu District  
Taipei 114  
Taiwan, R.O.C.  
Tel: +886 (2) 8797 5691  
Fax: +886 (2) 8751 9737

E-mail (Sales) [sales.apac@brtchip.com](mailto:sales.apac@brtchip.com)  
E-mail (Support) [support.apac@brtchip.com](mailto:support.apac@brtchip.com)

### Branch Office – Vietnam

Bridgetek VietNam Company Limited  
Lutaco Tower Building, 5th Floor, 173A Nguyen Van  
Troj,  
Ward 11, Phu Nhuan District,  
Ho Chi Minh City, Vietnam  
Tel : 08 38453222  
Fax : 08 38455222

E-mail (Sales) [sales.apac@brtchip.com](mailto:sales.apac@brtchip.com)  
E-mail (Support) [support.apac@brtchip.com](mailto:support.apac@brtchip.com)

### Web Site

<http://brtchip.com/>

### Distributor and Sales Representatives

Please visit the Sales Network page of the [Bridgetek Web site](#) for the contact details of our distributor(s) and sales representative(s) in your country.

System and equipment manufacturers and designers are responsible to ensure that their systems, and any Bridgetek Pte Ltd (BRT Chip) devices incorporated in their systems, meet all applicable safety, regulatory and system-level performance requirements. All application-related information in this document (including application descriptions, suggested Bridgetek devices and other materials) is provided for reference only. While Bridgetek has taken care to assure it is accurate, this information is subject to customer confirmation, and Bridgetek disclaims all liability for system designs and for any applications assistance provided by Bridgetek. Use of Bridgetek devices in life support and/or safety applications is entirely at the user's risk, and the user agrees to defend, indemnify and hold harmless Bridgetek from any and all damages, claims, suits or expense resulting from such use. This document is subject to change without notice. No freedom to use patents or other intellectual property rights is implied by the publication of this document. Neither the whole nor any part of the information contained in, or the product described in this document, may be adapted or reproduced in any material or electronic form without the prior written consent of the copyright holder. Bridgetek Pte Ltd, 178 Paya Lebar Road, #07-03, Singapore 409030. Singapore Registered Company Number: 201542387H.

## Appendix A - References

### Document References

FT93X webpage: [FT93x Webpage](#)

FT93x datasheet: [FT930/FT931/FT932/FT933 Datasheet](#)

FT93x user manual: [BRT AN 010 FT93x User Manual](#)

UMFTPD2A program module datasheet: [DS UMFTPD2A](#)

ME810A-HV35R LCD display module document: [DS ME810A HV35R](#)

### Acronyms and Abbreviations

Terms	Description
ADC	Analog-to-Digital Converter
DAC	Digital-to-Analog Converter
H/W	Hardware
I/O	Input/Output
I2C	Inter-Integrated Circuit
LCD	Liquid Crystal Display
LDO	Low Drop-Out
LED	Light-Emitting Diode
PWM	Pulse Width Modulation
QFN	Quad-Flat No-leads
RAM	Random Access Memory
SD	Secure Digital
SPI	Serial Peripheral Interface
UART	Universal Asynchronous Receiver/Transmitter
USB	Universal Serial Bus

## Appendix B - List of Figures and Tables

### List of Figures

Figure 4-1 – MM932LC Board Layout .....	5
Figure 4-2 – Power supply .....	6
Figure 4-3 – FT932 Microcontroller .....	6
Figure 4-4 – Flash Memory .....	7
Figure 4-5 – Flash Memory Interface .....	7
Figure 4-6 – USB Connectors Interface .....	8
Figure 4-7 – Programmer Interface .....	9
Figure 4-8 – SPI Master Interface .....	11
Figure 5-1 – MM932LC MCU and External I/O Bus .....	14
Figure 6-1 – MM932LC PCB Dimensions .....	16

### List of Tables

Table 2-1 – Ordering information .....	2
Table 4-1 – CN5 Pinout .....	9
Table 4-2 – J1 Pinout .....	10
Table 4-3 – CN1 External I/O Bus .....	12

## Appendix C – Revision History

Document Title: MM932LC Development Module Datasheet  
Document Reference No.: BRT\_000170  
Clearance No.: BRT#102  
Product Page: <http://brtchip.com/product/>  
Document Feedback: [Send Feedback](#)

Revision	Changes	Date
Version 1.0	Initial Release	2017-11-13