



MAX8513 Evaluation Kit

Evaluates: MAX8513

General Description

The MAX8513 evaluation kit (EV kit) demonstrates the MAX8513's standard application circuit. This EV kit operates from 9V to 16V, generating three positive output voltages.

The MAX8513 EV kit includes a voltage-mode synchronous step-down controller and two positive regulator gain blocks. The main synchronous step-down controller provides a 3.3V output with 2A output current. The positive regulator gain blocks use an external n-channel MOSFET pass transistor to generate 2.5V with 1.5A output current from the main 3.3V output, and an external pnp pass transistor to generate 12V with 0.100A output current using a coupled inductor from the step-down converter. The EV kit operates at 1.4MHz switching frequency, allowing the use of ceramic capacitors.

The MAX8513 EV kit can be reconfigured for other input voltage ranges or output voltages by selecting appropriate external components. The EV kit circuit features adjustable soft-start, current-limit, input power-fail detect (PFI), power-on reset (POR), power-fail output (PFO) and configurable power sequencing. Operation up to 1.4MHz allows the use of tiny surface-mount components and improves data rate in DSL applications by reducing noise interference.

Features

- ◆ **Input Voltages**
9V to 16V
- ◆ **Output Voltages**
3.3V Output at 2A (Step-Down DC-DC Converter)
2.5V Output at 1.5A (First LDO Regulator)
12V Output at 0.100A (Second LDO Regulator)
- ◆ **Adjustable Outputs**
- ◆ **Configurable Power-Up Sequencing for Outputs**
- ◆ **Adjustable Soft-Start and Foldback Current Limit**
- ◆ **Adjustable Input Power-Fail Circuit**
- ◆ **Switching Frequency Up to 1.4MHz**
- ◆ **Capable of Synchronizing to an External Clock**
- ◆ **Open-Drain POR and PFO Outputs**
- ◆ **Surface-Mount Components**
- ◆ **Fully Assembled and Tested**

Ordering Information

PART	TEMP RANGE	IC PACKAGE
MAX8513EVKIT	0°C to +70°C	28 QSOP

Component List

DESIGNATION	QTY	DESCRIPTION
C1, C8, C15	3	1 μ F \pm 20%, 16V X5R ceramic capacitors (0805) TDK C2012X5R1C105MT
C2	1	10 μ F \pm 20%, 35V X5R ceramic capacitor (1210) Taiyo Yuden GMK325F106ZH
C3, C9, C13	3	0.1 μ F \pm 10%, 25V X7R ceramic capacitors (0603) Murata GRM188R71E104K
C4	1	47 μ F \pm 20%, 6.3V X7R ceramic capacitor (1210) Taiyo Yuden JMK325BJ476MM
C5	1	4700pF \pm 5%, 50V X7R ceramic capacitor (0603) TDK C1608X7R1H472KT

DESIGNATION	QTY	DESCRIPTION
C6	1	10 μ F \pm 20%, 6.3V X5R ceramic capacitor (1206) Taiyo Yuden JMK316BJ106ML
C7, C18	2	1 μ F \pm 10%, 25V X7R ceramic capacitors (1206) TDK C3216X7R1E105K
C10	1	2.2 μ F \pm 10%, 10V X5R ceramic capacitor (0805) TDK C2012X5R1A225K
C11	1	680pF \pm 5%, 50V C0G ceramic capacitor (0603) Murata GRM1885C1H681J
C12	1	47pF \pm 5%, 50V C0G ceramic capacitor (0603) TDK C1608C0G1H470JT

MAX8513 Evaluation Kit

Evaluates: MAX8513

Component List (continued)

DESIGNATION	QTY	DESCRIPTION
C14	1	0.47 μ F \pm 10%, 16V X7R ceramic capacitor (0805) TDK C2012X7R1C474K
C16, C17, C21	0	Not installed, capacitors (0805)
C19	0	Not installed, capacitor (1206)
C20	1	1000pF \pm 10%, 50V X7R ceramic capacitor (0603) Murata GRM188R71H102K
C22	1	1000pF \pm 10%, 50V X7R ceramic capacitor (0603) TDK C1608X7RZH102K
D1	1	100mA, 30V Schottky diodes (SOD-523) Central Semiconductor CMOSH-3
D2	1	250mA, 75V ultra-high-speed diode (SOT23) Central Semiconductor CMPD4448
JU3	1	2-pin header
JU4	1	3-pin header
N1	1	30V, 5.5A/8.5A dual n-channel MOSFET (8-pin SO) Fairchild FDS6984S
N2	1	30V, 23A n-channel MOSFET (D-PAK) International Rectifier IRLR2703
Q1	1	40V, 600mA pnp transistor (SOT23) Central Semiconductor CMPT4403
R1	1	13.3k Ω \pm 1% resistor (0603)
R2	1	8.06k Ω \pm 1% resistor (0603)
R3	1	6.8k Ω \pm 5% resistor (0603)
R4	1	560 Ω \pm 5% resistor (0603)
R5	1	1.74k Ω \pm 1% resistor (0603)
R6, R14	2	806 Ω \pm 1% resistors (0603)
R7	1	10.7k Ω \pm 1% resistor (0603)

DESIGNATION	QTY	DESCRIPTION
R8, R9, R22	3	100k Ω \pm 5% resistors (0603)
R10	1	68.1k Ω \pm 1% resistor (0603)
R11	1	12.4k Ω \pm 1% resistor (0603)
R12	1	1k Ω \pm 5% resistor (0603)
R13	1	11.3k Ω \pm 1% resistor (0603)
R15	1	10 Ω \pm 5% resistor (0805)
R16	0	Not installed, 0.01 Ω \pm 5% current-sense resistor (1206) IRC LRF 1206-01-R010-J recommended
R17	1	665k Ω \pm 1% resistor (0603)
R18	1	66.5k Ω \pm 1% resistor (0603)
R19, R20	2	200 Ω \pm 5% resistors (0603)
R21	1	20 Ω \pm 5% resistor (0603)
R23	0	Not installed, resistor (0805)
R24	0	Not installed, resistor (2010)
R25	1	5.1 Ω \pm 5%, 0.5W resistor (2010) Panasonic ERJ-12ZYJ5R1U Vishay CRCW2010 5.1 5% 100 R02 SEI Electronics RMC 1/2 5.1 5% A
R26, R27	0	Not installed, resistors (0603)
R28	1	0 Ω \pm 5% resistor (0603)
R29	1	4.7 Ω \pm 5% resistor (0603)
R30	1	1.5k Ω \pm 5% resistor (1206)
RSENSE	1	0.02 Ω \pm 5% resistor (1206) IRC LRF 1206-01-R020-J
T1	1	Coupled inductor: Primary 1.8 μ H/4.5A/0.01 Ω Secondary/primary = 20:6 Coiltronics CTX 03-16101 or ICE ICA-1119
U1	1	MAX8513EEI (28-pin QSOP)
None	2	Shunts (JU3, JU4)
None	1	MAX8513 PC board

MAX8513 Evaluation Kit

Component Suppliers

SUPPLIER	PHONE	FAX	WEBSITE
Central Semiconductor	631-435-1110	631-435-1824	www.centrasemi.com
Cooper Coiltronics	561-752-5000	561-742-1178	www.cooperet.com
Fairchild	888-522-5372	N/A	www.fairchildsemi.com
ICE	703-257-7740	703-257-7547	www.icecomp.com
International Rectifier	310-322-3331	310-726-8721	www.irf.com
IRC	361-992-7900	361-992-3377	www.irctt.com
Kemet	864-963-6300	864-963-6322	www.kemet.com
Murata	770-436-1300	770-436-3030	www.murata.com
SEI Electronics	888-734-7347	919-850-9504	www.seielect.com
Taiyo Yuden	800-348-2496	847-925-0899	www.t-yuden.com
TDK	847-803-6100	847-390-4405	www.componet.tdk.com

Note: Indicate that you are using the MAX8513 when contacting these component suppliers.

Quick Start

The MAX8513 EV kit is fully assembled and tested. Follow these steps to verify board operation. **Do not turn on the power supply until all connections are completed:**

- 1) Verify that a shunt is not installed across jumper JU3 (EN/SYNC, enabled).
- 2) Verify that a shunt is across pins 1 and 2 of jumper JU4 (SEQ, outputs tracking).
- 3) Connect a voltmeter to the VOUT1 pad and the PGND pad.
- 4) Connect a 9VDC to 16VDC power supply to the VIN pad.
- 5) Connect the supply ground to the PGND pad.
- 6) Turn on the power supply.
- 7) Verify that the main output (VOUT1) is 3.3V, the first LDO regulator output (VOUT2) is 2.5V, and the second LDO regulator (VOUT3) is 12V.

For instructions on selecting the feedback resistors for other output voltages, see the *Evaluating Other Output Voltages* section.

Detailed Description

The MAX8513 EV kit includes a voltage-mode synchronous step-down controller and two positive regulator gain blocks. The main synchronous step-down controller provides a 3.3V output with 2A output current. The positive regulator gain blocks use an external n-channel MOSFET pass transistor to generate 2.5V with 1.5A output current from the main 3.3V output, and an external pnp pass

transistor to generate 12V with 0.100A output current using a coupled inductor from the step-down converter. The EV kit operates from a 9V to 16V input range, and a DC source that provides the EV kit up to 2A of current. The EV kit can be reconfigured for other input voltage ranges up to 28V.

The MAX8513 EV kit features a coupled inductor (T1) to store energy for the 3.3V output (VOUT1) and 12V output (VOUT3). Resistors R1 and R2 set the output voltage for the 3.3V step-down DC-DC converter. The output voltage can be adjusted from 1.25V to 5.5V. Refer to the MAX8513 data sheet for more information on setting the output voltage.

The 2.5V LDO regulator circuit derives its power from the 3.3V main output (VOUT1). An n-channel MOSFET is used as the linear pass element for regulating the 2.5V output (VOUT2). Resistors R5 and R6 set the output voltage for the 2.5V LDO regulator's output. The output voltage can be adjusted from 0.8V to 3.3V (45V logic gate MOSFET). Refer to the MAX8513 data sheet for more information on setting the output voltage. Jumper JU5 and PC board pad SUP2 are provided to enable an external voltage source to drive the gate of N1. The voltage source must be 1V above N1's fully-enhanced gate-drive voltage plus the voltage at VOUT2.

The EV kit's 12V LDO regulator circuit utilizes coupled inductor T1 secondary winding and diode D2 to increase the voltage available to the 12V output pass transistor Q1. The 12V output linear pass element is a pnp surface-mount transistor using the PC board for heat dissipation.

Evaluates: MAX8513

MAX8513 Evaluation Kit

Resistors R13 and R14 set the output voltage for the 12V LDO regulator output. The output voltage can be adjusted from 0.8V to 27V (12V as configured). Refer to the MAX8513 data sheet for more information on setting the output voltage. The MAX8513 EV kit features several jumper options that are configurable for choosing the shutdown and clock synchronizing mode (JU3) and power-on sequencing of the outputs (JU4). The EV kit can also be reconfigured for using a more accurate current-sensing resistor (R16) after modifications (see the *Current-Limit Sensing Methods* section for a complete description of the two methods and configurations).

Multifunction jumper JU3, along with resistor R7, can be configured to enable the MAX8513 and to set the switching frequency up to 1.4MHz for the 3.3V converter. Jumper JU3 can also be configured for shutdown mode that reduces the MAX8513 shutdown current to less than 200 μ A (typ). All outputs are turned off in this mode. When configured for synchronizing mode, an external TTL/CMOS square-wave clock is used to synchronize and set the switching frequency of the MAX8513. The SYNC PC board pad is provided for connecting the external clock (see Table 1 for more information on the external clock).

The MAX8513 EV kit features a jumper (JU4) to select the outputs' power-up mode: an output tracking or an output stagger-sequence mode. In output tracking mode, VOUT1, VOUT2, and VOUT3 are turned on at the same time. When configured for the output stagger-sequence mode, once VOUT1 reaches 90% (2.9V), then VOUT2 is softly turned on. Once VOUT2 reaches 90% (2.2V), VOUT3 is softly turned on. Individual soft-start on VOUT2 and VOUT3 eliminates glitches on the previous stages due to the charging output capacitors.

Table 1. Jumper JU3 Functions

SHUNT LOCATION	EN/SYNC PIN	EV KIT OPERATING MODE
None	Connected to R22	Enabled mode: 1.4MHz set by resistor R7
Installed (high or low)	Connected to GND	Shutdown mode: VOUT1, VOUT2, VOUT3 = Disabled
None	Connected to an external TTL/CMOS clock source	Enabled and synchronization mode: synchronized to an external clock frequency

The EV kit circuit also includes soft-start and a configurable input power-fail circuit. Resistors R10 and R11 can be replaced to evaluate other input power-fail voltages. Lastly, open-drain outputs with pullup resistors to the 3.3V main output are available for the MAX8513 $\overline{\text{POR}}$ and $\overline{\text{PFO}}$ pins of the MAX8513. These output signals are available on the EV kit's $\overline{\text{POR}}$ and $\overline{\text{PFO}}$ pads.

Jumper Selection

Shutdown Control and Clock Synchronization

The MAX8513 EV kit has a multifunction jumper that features a shutdown mode to reduce the MAX8513 shutdown current or synchronize to an external TTL/CMOS clock source. The 2-pin jumper JU3 selects the shutdown mode or clock synchronization and frequency for the MAX8513. Table 1 lists the jumper options.

The TTL/CMOS clock source must provide the following signal qualities:

- Output voltage:
 - Logic low = 0V to 0.8V
 - Logic high = 2.4V to 5.5V
- Output frequency = 1.4MHz \pm 30% (MAX8513 synchronization range is 200kHz to 1.4MHz; refer to the MAX8513 data sheet for more information.)
- Duty cycle = 200ns (min) pulse width (high or low)

Connect the external clock to the SYNC and GND pads. Refer to the MAX8513 data sheet for selecting a different switching frequency and choosing resistor R7.

Output Power-Up Sequence Control

The MAX8513 EV kit features two modes for powering up the outputs: an output tracking or an output stagger-sequence mode. The 3-pin jumper JU4 selects the mode of operation for the EV kit's outputs. Table 2 lists the selectable jumper options.

Table 2. Jumper JU4 Function

SHUNT LOCATION	SEQ PIN	MAX8513 OUTPUTS
1 and 2	Connected to MAX8513 VL pin	Output tracking mode
2 and 3	Connected to GND	Output stagger sequence mode

MAX8513 Evaluation Kit

SUP2 External Supply (N2 Gate Voltage)

The MAX8513 EV kit features two methods of providing the VOUT2 linear pass MOSFET maximum gate voltage: the MAX8513 IN pin or an external voltage source 1V above the desired gate-drive voltage plus the voltage at VOUT2. The 2-pin jumper JU5 selects the gate-drive source. Table 3 lists the selectable jumper options. **Note: The MOSFET's maximum V_{GS} rating must not be exceeded. The maximum voltage rating of the MAX8513 SUP2 pin must not be exceeded.**

Table 3. Jumper JU5 Function

PC TRACE SHORT	SUP2 PIN	SUP2 SOURCE
Shorted (default)	Connected to MAX8513 IN pin	VIN supply's voltage to the SUP2 pin through R23
Cut Open	Connected to SUP2 pad	External voltage source connected to SUP2 pad and PGND

Evaluating Other Output Voltages

Step-Down DC-DC Converter (VOUT1 Output)

The MAX8513 EV kit's step-down DC-DC converter main output (VOUT1) is set to 3.3V by feedback resistors R1 and R2. To generate output voltages other than 3.3V (1.25V to 5.5V), select different voltage-divider resistors (R1, R2). Additionally, coupled inductor T1, input and output capacitors, and compensation components should be evaluated. Refer to the MAX8513 data sheet for information on selecting all these components.

2.5V LDO Regulator Output (VOUT2 Output)

The MAX8513 EV kit's 2.5V LDO regulator output (VOUT2) is set to 2.5V by feedback resistors R5 and R6. To generate output voltages other than 2.5V (0.8V to 3.3V), select different voltage divider resistors (R5, R6). This output must be limited to 1.5A because of the coupled inductor's (T1) primary-side current rating. Lower output values cause additional power dissipation at MOSFET N2. Refer to the MAX8513 data sheet to adjust the compensation components when charging the output voltage and maximum current.

12V LDO Regulator Output (VOUT3 Output)

The MAX8513 EV kit's 12V LDO regulator output (VOUT3) is set to 12V by feedback resistors R13 and R14. To generate output voltages other than 12V (0.8V to 27V), refer to the MAX8513 data sheet to select different voltage-divider resistors and the coupled inductor turns ratio.

Evaluating Other Input Voltages and Current-Limit Sensing Methods

VIN Input

The MAX8513 EV kit is factory configured for an input voltage range of 9V to 16V at the VIN input. Higher input voltages up to 28V can be evaluated once capacitors C18 and C19 have been replaced with appropriate voltage-rated capacitors. Additionally, for lower input voltages, MOSFET N1 can be replaced with a lower V_{DS}-rated MOSFET to reduce cost. Coupled inductor T1, input and output capacitors, and compensation components should be evaluated also. Refer to the MAX8513 data sheet for information on selecting these components.

Current-Limit Sensing Methods

The MAX8513 EV kit features two methods for current-limit sensing at the step-down DC-DC converter's output: a low-cost lossless method or a more accurate current-sense resistor. By default the EV kit is configured for the lossless method, which uses the coupled inductor's (T1) primary-side DC resistance, capacitor C14, and resistors R19 and R20 to sense the output current. Refer to the MAX8513 data sheet for additional information on choosing other values for resistors R19 and R20 and capacitor C14. This low-cost method provides adequate current-limit and short-circuit protection for most applications.

The more accurate current-sense resistor method can also be evaluated. To evaluate the current-sense resistor method, cut open the PC board trace-shortening resistor R16 and install resistor R_{SENSE} (provided on the EV kit) on to R16 pads. Move R19 and install it at resistor R26 pads. Remove resistor R28 and install it at R27 pads.

MAX8513 Evaluation Kit

Evaluates: MAX8513

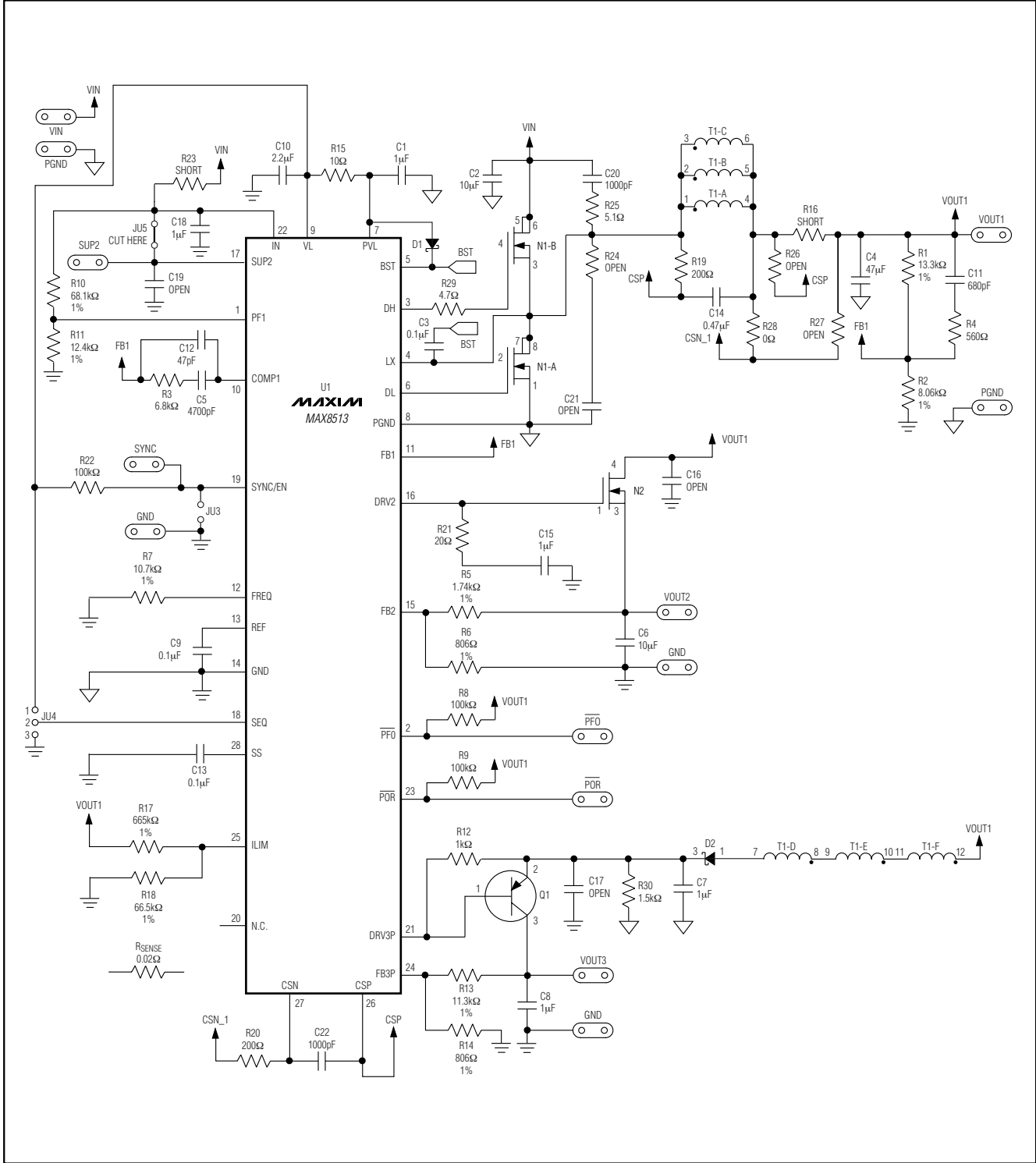

Figure 1. MAX8513 EV Kit Schematic

MAX8513 Evaluation Kit

Evaluates: MAX8513

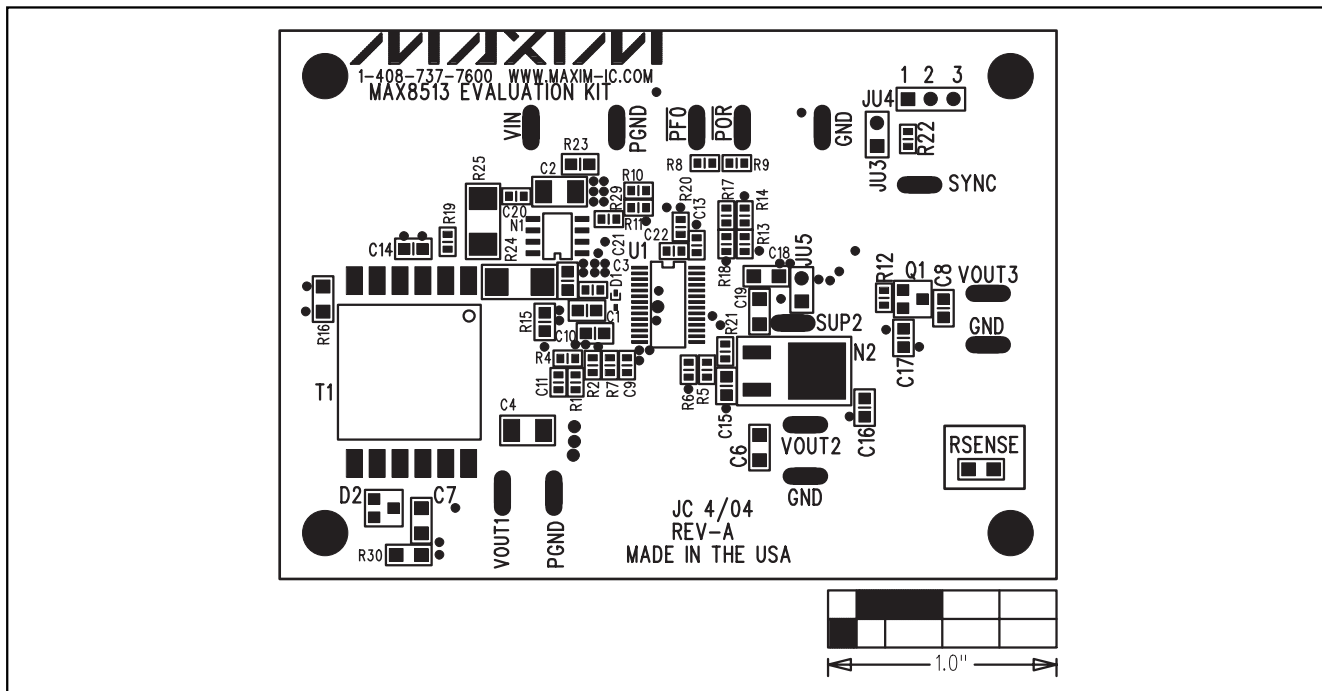

Figure 2. MAX8513 EV Kit Component Placement Guide—Component Side

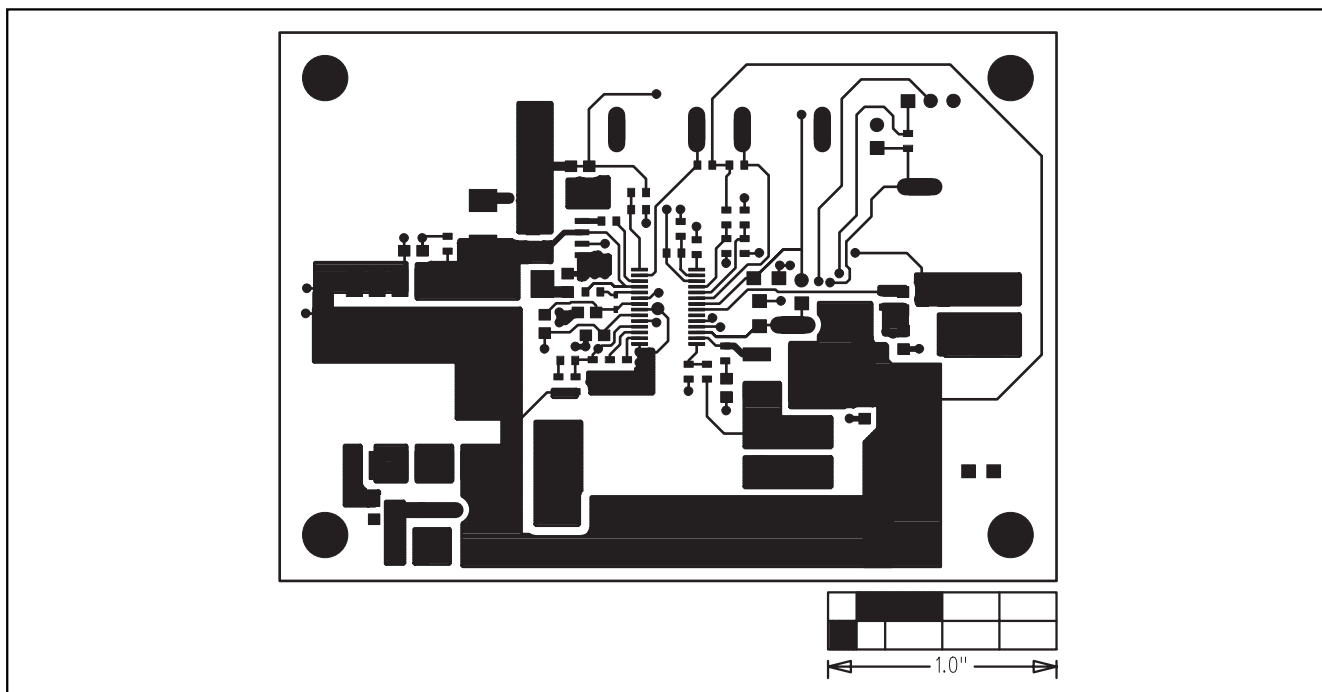

Figure 3. MAX8513 EV Kit PC Board Layout—Component Side

MAX8513 Evaluation Kit

Evaluates: MAX8513

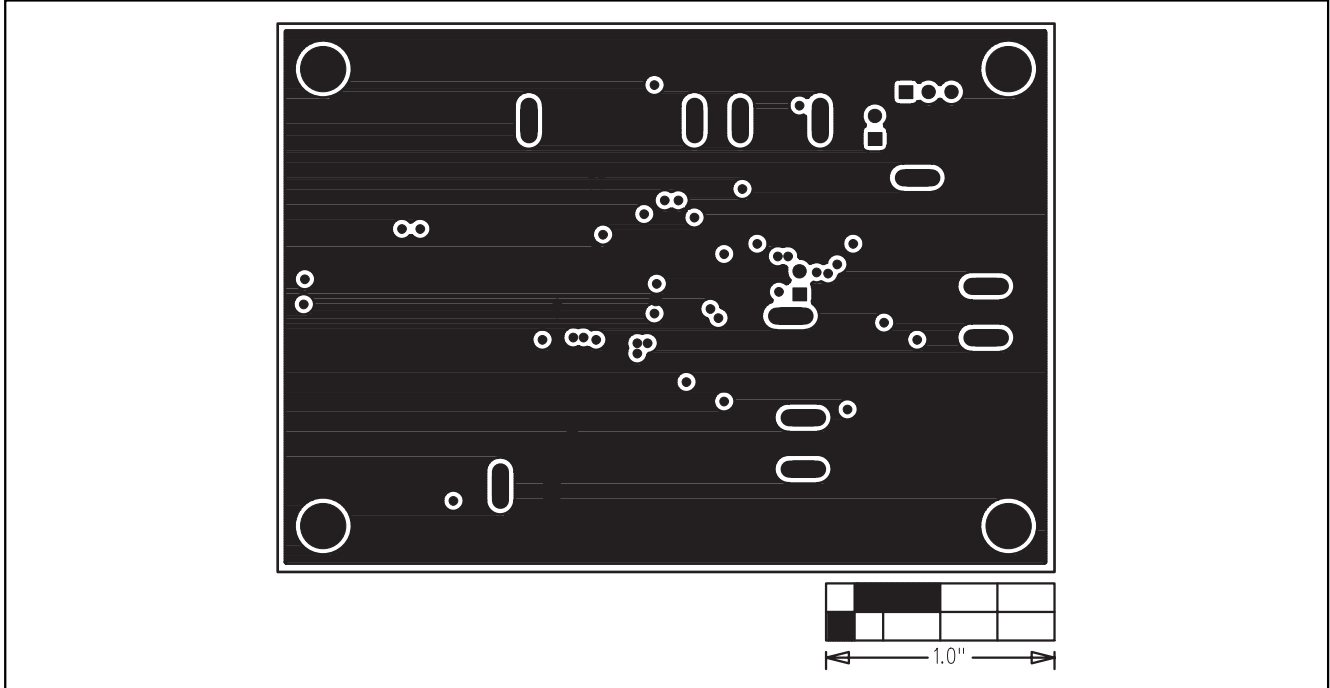

Figure 4. MAX8513 EV Kit PC Board Layout—PGND Layer 2

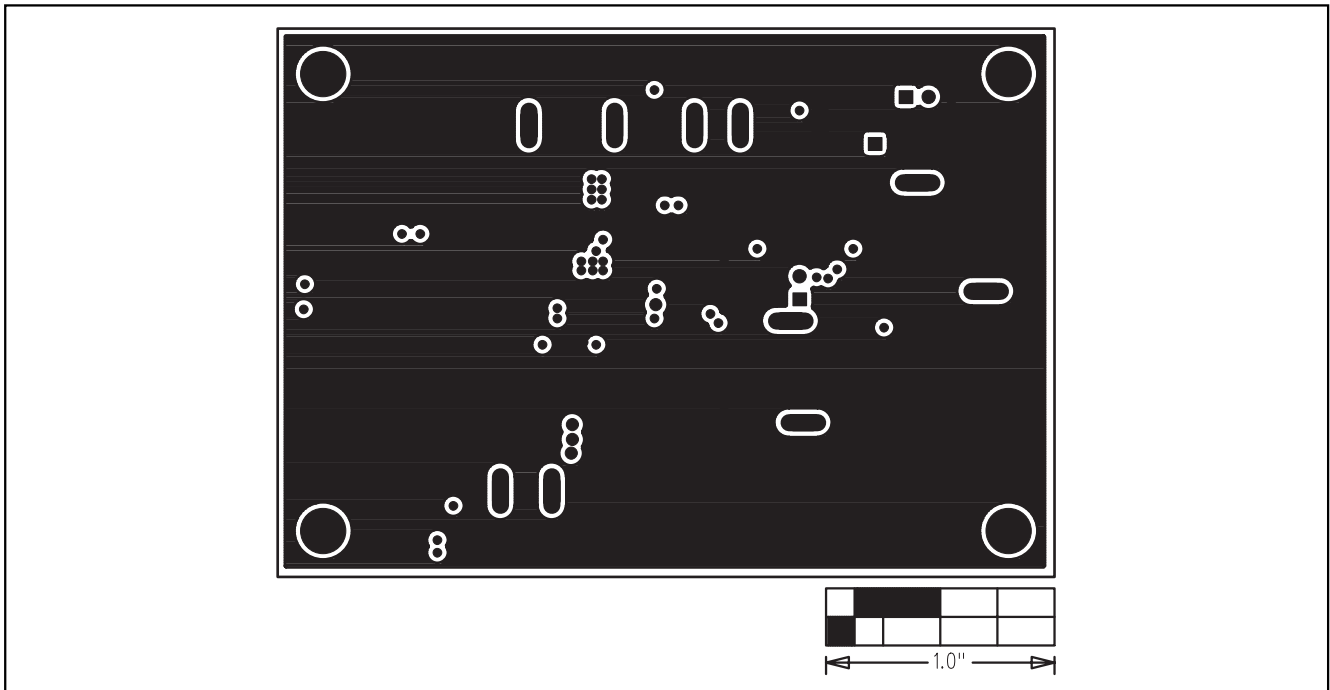

Figure 5. MAX8513 EV Kit PC Board Layout—GND Layer 3

MAX8513 Evaluation Kit

Evaluates: MAX8513

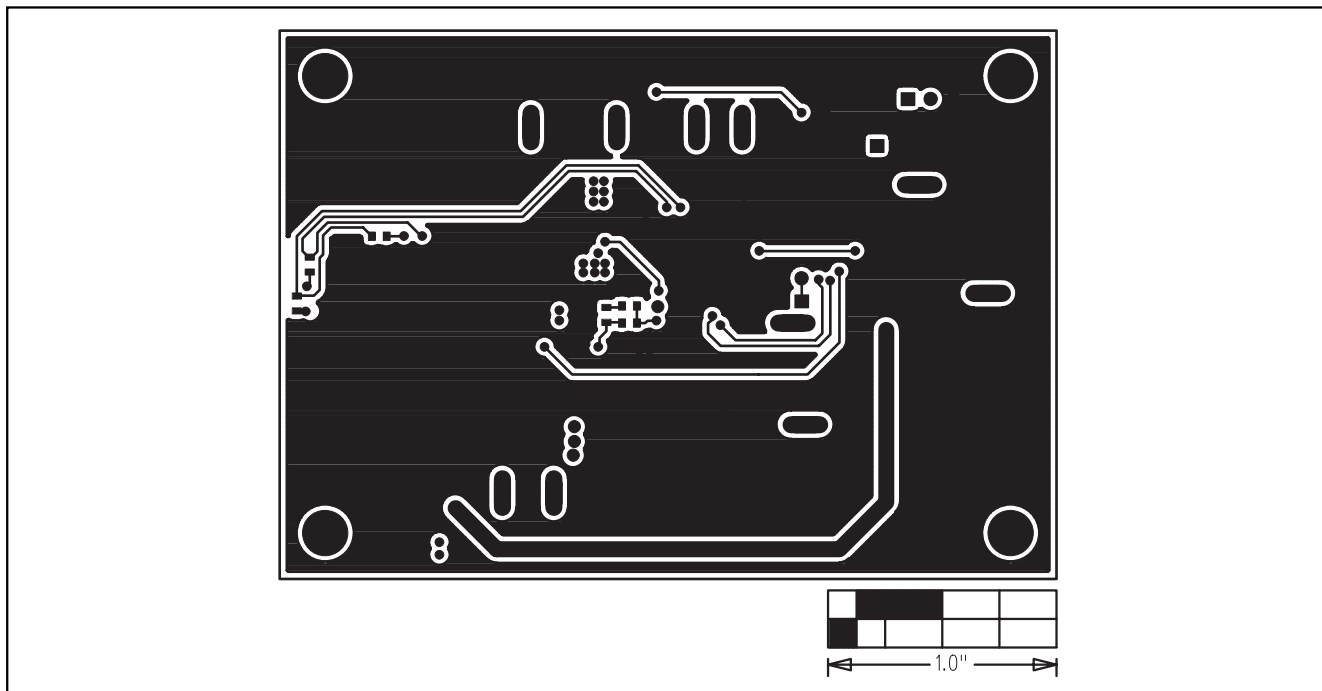

Figure 6. MAX8513 EV Kit PC Board Layout—Solder Side

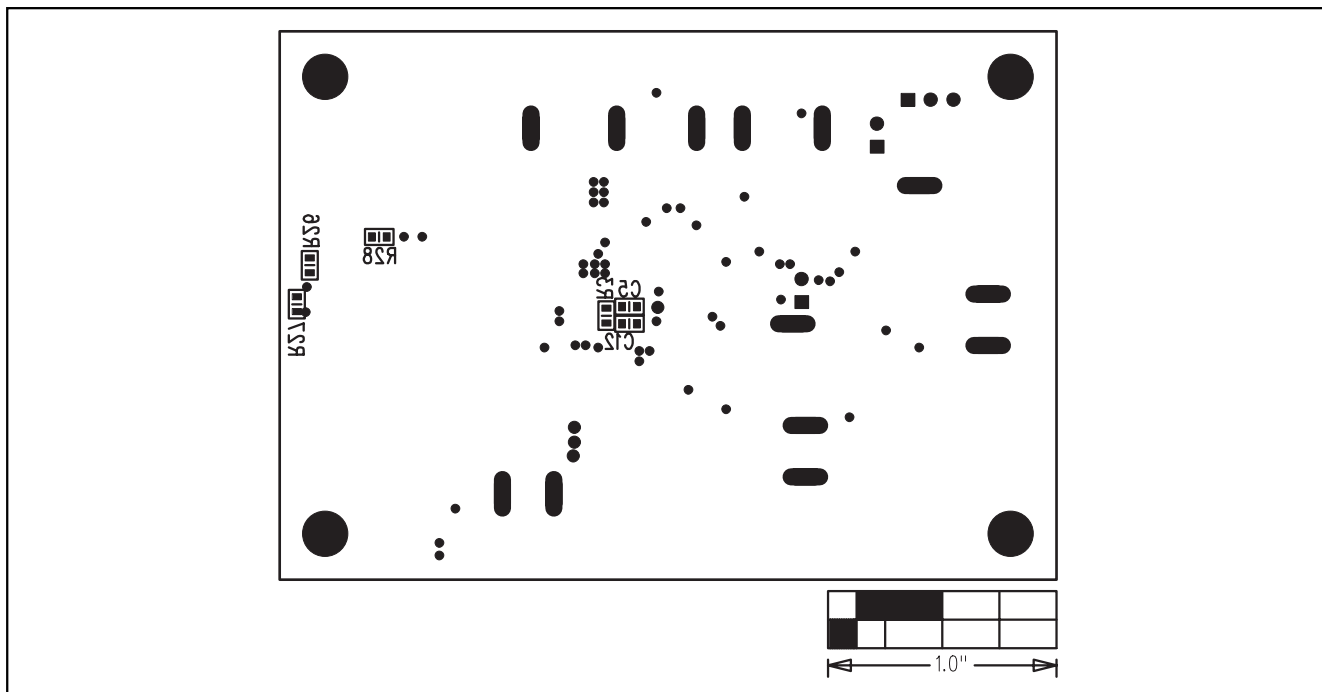

Figure 7. MAX8513 EV Kit Component Placement Guide—Solder Side

Maxim cannot assume responsibility for use of any circuitry other than circuitry entirely embodied in a Maxim product. No circuit patent licenses are implied. Maxim reserves the right to change the circuitry and specifications without notice at any time.

Maxim Integrated Products, 120 San Gabriel Drive, Sunnyvale, CA 94086 408-737-7600 _____ 9