

## **Application Note AS3932**

Description of the AS3932 Demosystem

Revision: 1.01

## Contents

<b>1</b>	<b>INTRODUCTION .....</b>	<b>3</b>
<b>2</b>	<b>OVERVIEW OF THE RX BOARD.....</b>	<b>3</b>
<b>3</b>	<b>OVERVIEW OF THE TX BOARD.....</b>	<b>7</b>
<b>4</b>	<b>HOW TO QUICKLY GET STARTED .....</b>	<b>9</b>
4.1	RANGE MEASUREMENT.....	9
4.2	RSSI MEASUREMENTS .....	9
4.3	HOLD MAX RSSI .....	9
4.4	PATTERN DETECTION: PATTERN1 AND PATTERN2.....	10
4.5	FALSE WAKEUP .....	10
4.6	MANCHESTER DECODER.....	11
4.7	CHANNEL MULTIPLEXING AND ON/OFF MODE .....	11
4.8	ARTIFICIAL WAKEUP .....	11

## 1 Introduction

The demo-kit consists of a AS3932 LF wake-up receiver board, a 3V CR2032 Lithium Battery, a LF transmitter board and a 9V power supply. The power supply cable is not included and has to be chosen according to the specific plug (depending on the country).

The receiver board supports 3-dimensional field detection and can show the main functionality of the AS3932. **The receiver board can work completely stand alone; in fact neither power supply nor a PC are needed.** It is possible to see the AS3932 main functionality just operating the switches present on the board. The chip will be programmed using a microcontroller.

The transmitter board generates the field capable to wake the receiver up. Even this board does not need any PC connection but has to be supplied by the included power supply.

## 2 Overview of the RX board

The receiver board (RX-Board) consist of an AS3932 LF-Wakeup receiver, a microcontroller for programming the device, a set of 3-dimensional coils XYZ, a main switch, 2 pin connectors shorted with a jumper (where to measure the current consumption of the AS3932), a set of 4 pin connectors where to monitor the out coming signals of the AS3932, a bank of 8-dipswitches for the AS3932 programming, 4 buttons (SEND, CL\_W, R\_RSSI, CL\_F), 3 LED arrays (5 LEDs each) showing the RSSI of each channel, 3 LEDs showing the active channels and a holder for a CR2032 Lithium battery.

A top view of the board is shown in the Fig. 1.

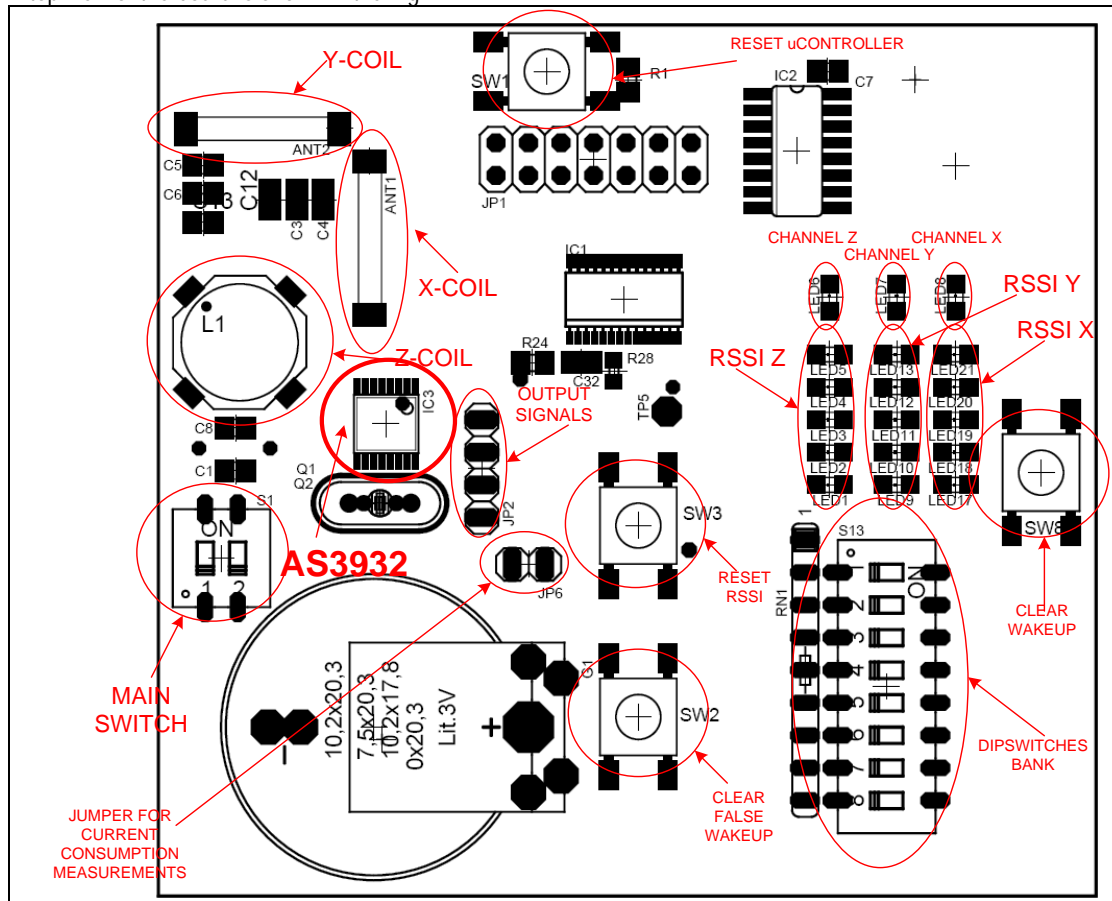

Figure 1: top view of the AS3932 LF Wake-up Receiver demo board

To power-up the board, the battery has to be set into the battery holder, facing the plus (+) up, the main switches (1+2) have to be switched-on and the microcontroller has to be reset by pushing the button R\_MCU (reset microcontroller). The 3-coils make an angle of 90 degrees in order to pick up the field coming from all three directions and each coil is connected to a channel input of the AS3932. Right in the middle there are 4 pin connectors. A detail is shown in the Figure 2.

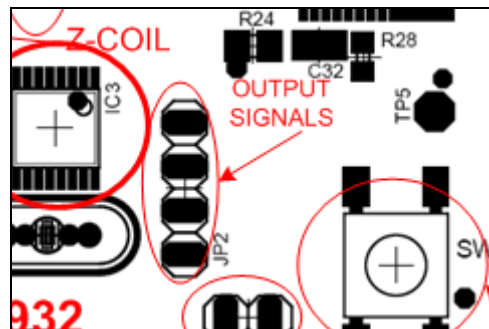

Figure 2: pin connector's detail.

The pin connector's functionality is described below (top to bottom):

1. GND is the ground
2. WAKE is the wakeup signal
3. DAT\_CL is the data clock, in case the Manchester decoder is enabled
4. DAT is the data pin (the demodulated data are streamed out).

Just beside these 4 pins there are 2 pins shorted by a jumper. By disconnecting the jumper and connecting in series an amp meter it is possible to measure the current consumption of the AS3932 only.

Once the main switch is switched on it is possible to program the AS3932 and explore its wide set of functionality. It is possible to let the chip working in different mode using the switches of the dipswitch bank. **Every time that a new setup is chosen, the button SEND have to be pressed.** Here there is a list of the functionality of each switch:

Switch Nr1: **W\_PATT**. This switch enables the pattern detection. The pattern to be detected is defined in the Switch Nr. 7 (PATT2). In normal mode (switch off) the pattern correlation is not enabled and the wakeup is based only on the frequency detection (125 kHz). If a carrier is detected the channel with the biggest input signal (biggest RSSI) is put through, the signal on the wakeup pin goes high, the data are present on the DAT pin, the LED related to the active channel will light on and the related RSSI will be displayed. With a short pressing of the button CL\_W the chip will be set to listening mode again and both the channel selection and the RSSI will be reset. With a longer pressing on the button CL\_W it is possible to reset automatically the chip without pressing the CL\_W button anymore.

If the pattern detection is enabled (switch on) the RSSI LEDs matrix will show a cross till the wakeup pattern is not detected, as shown in the next figure

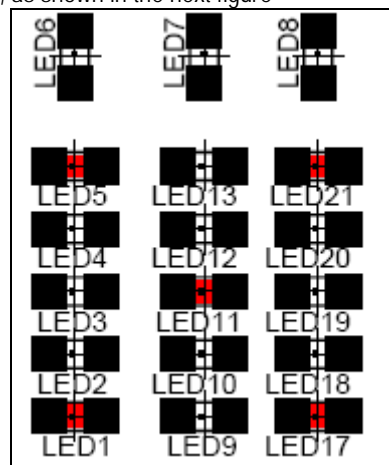

Figure3: no wakeup detection

As soon as the pattern is detected the RSSI LEDs matrix will show a rhomb, as shown in the next figure the signal on the pin WAKE goes high and the data will be displayed on the DAT pin.

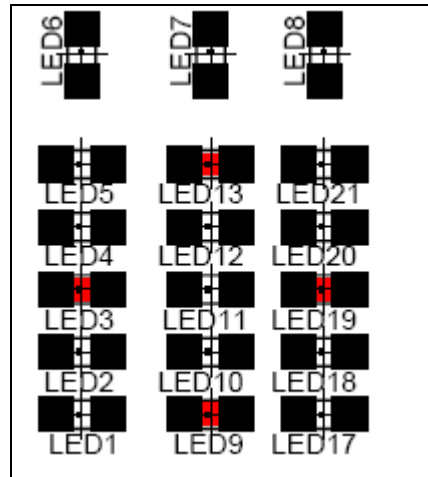

Figure4: wakeup detected

The chip will remain in this state for a while, then the microcontroller will automatically reset the chip and the AS3932 goes back to the listening mode and the WAKE pin goes low again. With a longer pressing on the CL\_W button the wakeup state will not be cancelled automatically anymore; in this mode the user has to set the AS3932 back to sleep-mode manually, with a short pressing of the button CL\_W.

Switch Nr2: **MANCH**. This switch enables the Manchester decoder. If this switch is set to ON, once the chip enters the wakeup mode the data coming out on the DAT pin are automatically Manchester-decoded and the clock is present on the DAT\_CL pin. In normal operation (switch off) the Manchester decoder is not enabled.

Switch Nr3: **MUX123**. This switch sets the chip in the "Sniff mode" (one of the two available power saving mode, see data sheet). In this mode the current consumption becomes about 3,5uA, to be used only with pattern detection (W\_PATT = on).

Switch Nr4: **ON/OFF**. This switch sets the chip in the "On/Off mode" (one of the two available power saving mode, see datasheet). In this mode the current consumption becomes about 4,5 uA, to be used only with pattern detection (W\_PATT = on).

Switch Nr5: **RSSI\_UP**. If this switch is set to on, the maximum RSSI will be displayed on the RSSI LEDs matrix. In the normal operation mode (switch off) it is possible always to display the actual RSSI.

Switch Nr6: **AUTO\_W**. this option has to be used together with W\_PATT (both W\_PAT and AUTO\_W have to be set to on). In this mode the chip can normally detect the pattern but in addition a 128us interrupt will be produced every 5 second, even if no pattern is detected. This is the so called "Artificial wakeup" (see device specifications)

Switch Nr7: **PATT2**. This switch defines which pattern has to be detected. In normal operation (switch off) the chosen pattern is the Pattern1 (96 HEX), while if the switch is set to 1 the Pattern2 (C8 HEX) will be detected. Both of them can be transmitted from the Transmitter Board (TX-Board).

Switch Nr8: **not used**. The position of this switch (ON/OFF) doesn't influence the AS3932 behaviour.

Once the user has chosen the setup the SEND button has to be pressed. This action has to be repeated every time the set-up is changed.

Next to the 8-dipswitches bank there is a LED matrix. This matrix shows the RSSI of all 3 channels. If the chip is woken up the RSSI of the strongest channel will be displayed (binary coded).

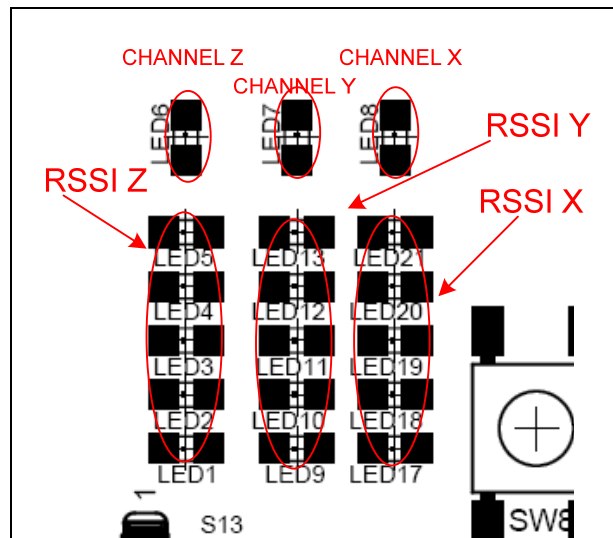

Figure 3: RSSI LED's

The three vertical positioned LEDs show which channel is active, once the AS3932 leaves the listening mode. Below these three LEDs there are three LED columns (5 LEDs each), where the RSSI is represented. The upper LED shows the LSB, while the one on the bottom the MSB. The RSSI is binary represented.

On the board there are 4 buttons:

**SEND:** pressing this button the chosen setup will be applied to the chip.

**CL\_W:** this is a dual purpose button. With a short pressing of this button the chip is set back to listening mode (the wakeup state is cleared). With a longer pressing of this button (2 sec. circa) the "clear wakeup" will be automatically done every time the chip is woken up.

**R\_RSSI:** pressing this button the RSSI will be cleared.

**CL\_F:** this is a dual purpose button. With a short pressing of this button it is possible to show how many false wake-ups have been detected by the AS3932 (the false wakeup will be displayed on the RSSI matrix in the RSSI2 column). With a longer pressing the number of "false wake-ups" will be cleared.

### 3 Overview of the TX board

The LF Transmitter Board (TX-board) consist of a 9-12V DC plug, a microcontroller, an antenna and 5 buttons. The TX-board needs to be connected to the power supply provided in the kit. The power supply has to be connected to the power line with an appropriated cable (not included).

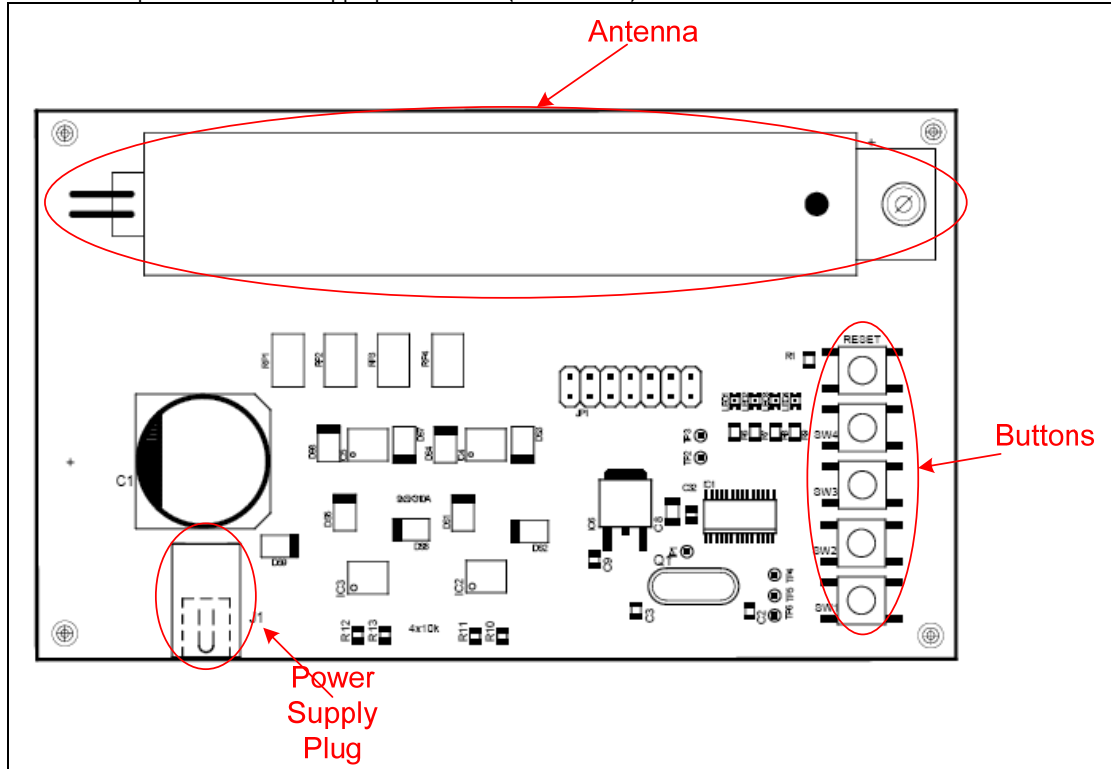

The carrier frequency of the TX-board is 125 kHz.  
On the board 5 buttons are present:

**RST\_MCU:** this button resets the system and sets the board in a standby mode (no signal is produced on the antenna) this button has to be pushed every time after powering on the board.

**PATT1:** pressing this button the board will send only one time the Pattern1 following the preamble. When the Pattern1 is sent no more activity will be present on the antenna.

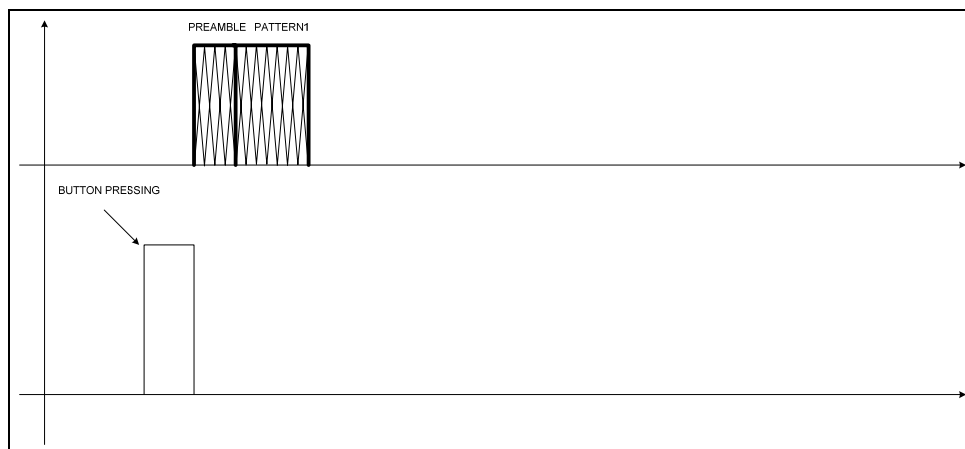

**PATT2:** pressing this button the board will send only one time the Pattern2 following the preamble. When the Pattern2 is sent no more activity will be present on the antenna.

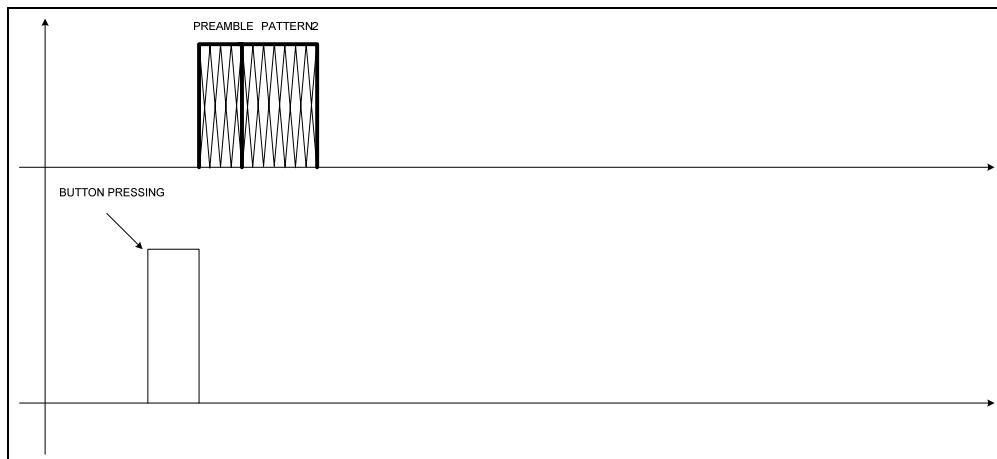

**CONT\_P1:** pressing this button the board will send continuously the Pattern1 every 1 sec. circa. To go back to standby mode the button RST\_MCU must be pressed.

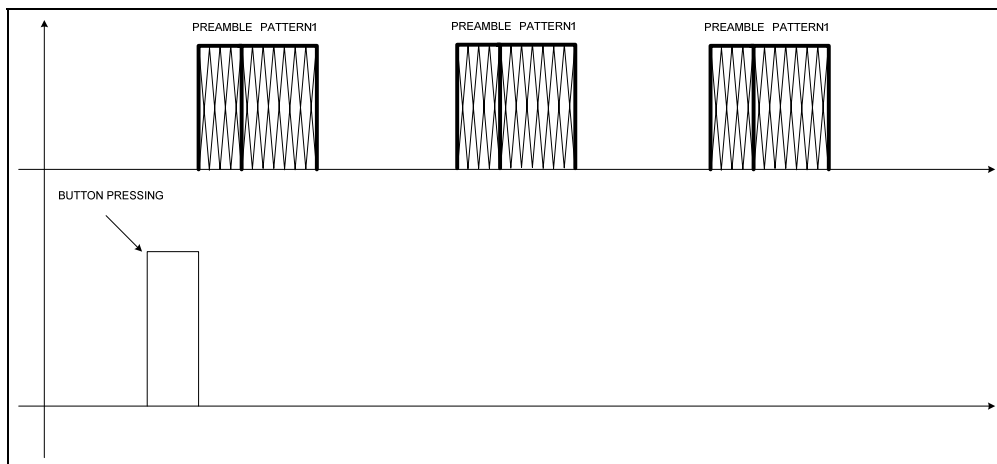

**CONT\_10:** pressing this button it will be continuously sent carrier OOK modulated with a frequency of 1.35 kHz.

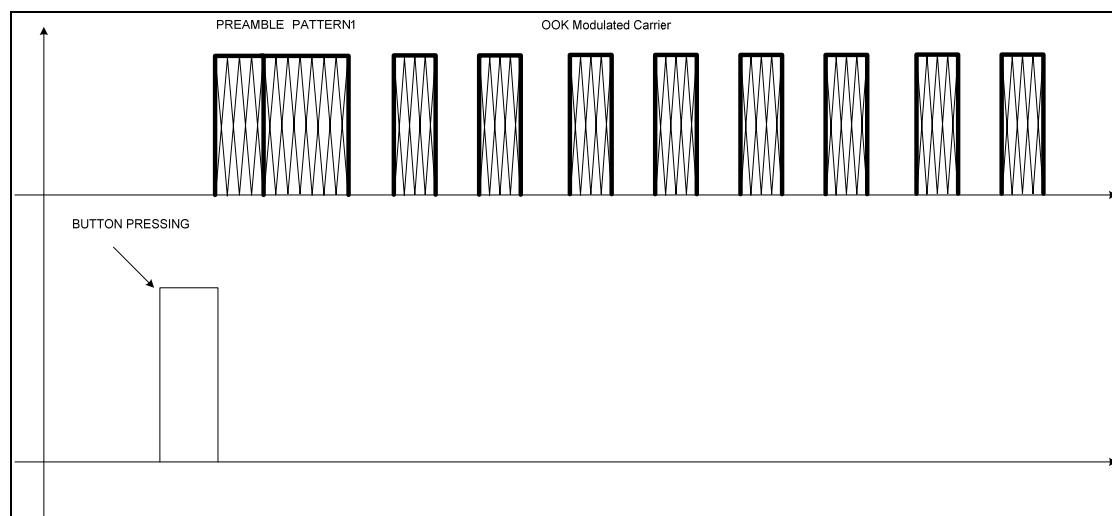



## 4 How to quickly get started

- Unpack the TX-board and RX-board
- Power up the TX board with the power supply (provided in the kit)
- Push the RST\_MCU button on the TX-board (the board will be set to a stand-by mode)
- On the RX board, insert the battery into the battery holder and switch on the board.

### 4.1 Range measurement

On the **RX-board**:

- Switch the board on
- Set the dipswitch **W\_PATT** to on and all other switches to off
- Press the button **SEND**

Once those operations have been done, on the RSSI LEDs matrix a cross will be displayed

On the **TX-board**:

- Push the button **RST\_MCU**
- Push the button **CONT\_P1**

Since the button CONT\_P1 has been pushed the TX board sends the PATTERN1 roughly once a second. Every time that the pattern is received and recognised by the AS3932 a rhomb will be displayed on the RSSI matrix. After recognising the pattern the AS3932 will be automatically set back to listening mode and the cross will appear on the RSSI matrix. By moving the RX-board away from the TX-board it is possible to see what the maximum communication range of the system is.

### 4.2 RSSI measurements

On the **RX-board**:

- Switch the board on
- Set all dipswitches to off
- Press the button **SEND**
- Push the button **CL\_W** longer than 2sec

On the **TX-board**:

- Push the button **RST\_MCU**
- Push the button **CONT\_10**

Once those operations have been done, the RSSI will be shown on the RSSI matrix. By moving the RX-board away from the TX-board it is possible to see how the RSSI changes in relation to the distance.

### 4.3 Hold max RSSI

On the **RX-board**:

- Switch the board on
- Set the dipswitch **RSSI\_UP** to on and all other dipswitches to off
- Press the button **SEND**

On the **TX-board**:

- Push the button **RST\_MCU**
- Push the button **CONT\_10**

Once those operations have been done, the RSSI will be shown on the RSSI matrix. Moving the RX-board nearer the TX board the RSSI will increase, while going farer and farer from the TX-board the RSSI will not decrease. In this way the max RSSI will be hold.

#### 4.4 Pattern detection: PATTERN1 and PATTERN2

On the **RX-board**:

- Switch the board on
- Set the dipswitch **W\_PATT** to on and all other switches to off
- Press the button **SEND**

Once those operations have been done, on the RSSI LEDs matrix a cross will be displayed. The AS3932 is programmed to wakeup on the PATTERN1.

On the **TX-board**:

- Push the button **RST\_MCU**

If the RX-board is inside the communication range, every time that the button PATT1 on the TX-board is pressed the wakeup will be displayed on the RX-board (the symbol on the RSSI matrix will change from a cross to a rhomb).

It is possible to see that the board doesn't wakeup if the button PATT2 on the TX board is pressed. This happens because the AS3932 is programmed to detect the PATTERN1. If the PATTERN2 has to be detected then the following operation has to be done on the RX-board:

- Set the switch **PATT2** on, on the **RX-board**
- Press the button **SEND** on the **RX-board**

In this way the AS3932 is programmed to wakeup on the PATTERN2. on the TX-board, every time that the button PATT2 is pressed the wakeup will be generated on the RX-board (the symbol on the RSSI matrix will change from a cross to a rhomb). On the other hand if PATT1 is pushed on the TX-board no reaction will be seen on the RX board.

#### 4.5 False wakeup

A false wakeup occurs every time that the received pattern doesn't correspond to the right one. The number of false wakeup detections is stored in a register of the AS3932. This register can be accessed by the microcontroller. The microcontroller can also clear the content of this register.

On the RX-board it is possible to read the false wakeup register with a short pressing of button **CL\_F**, while the register can be cleared with a longer pressing (2 sec. circa) of the same button.

On the **RX-board**:

- Switch the board on
- Set the dipswitch **W\_PATT** to on and all other switches to off
- Press the button **SEND**
- Press for longer than 2 sec. the button **CL\_F**

On the **TX-board**:

- Push the button **RST\_MCU**

In this way the RX-board is programmed to detect the PATTERN1, so if the PATTERN2 is sent n-times (just by pressing the button PATT2 on the TX board) the n false wakeup will be stored in the AS3932. To see the n false

wakeup it is sufficient to shortly press the button CL\_F. The number of false wakeups will be shown in binary coding, using the LEDs of RSSI Y.

The false wakeup information is stored in a volatile memory; therefore every time that the battery is taken away this information will be lost.

#### 4.6 Manchester decoder

On the **RX-board**:

- Switch the board on
- Set the dipswitches **W\_PATT** and **MANCH** to on and all other switches to off
- Press the button **SEND**

On the **TX-board**:

- Push the button **RST\_MCU**
- Push the button **CONT\_10**

In this way the TX-board transmits continuously a 125 kHz carrier OOK modulated

With the help of an oscilloscope it is possible to see that the signal at the pin WAKE is high and that on the DAT pin the received data are coming out with its related clock on the DAT\_CL pin. The next figure shows what will be shown on the oscilloscope

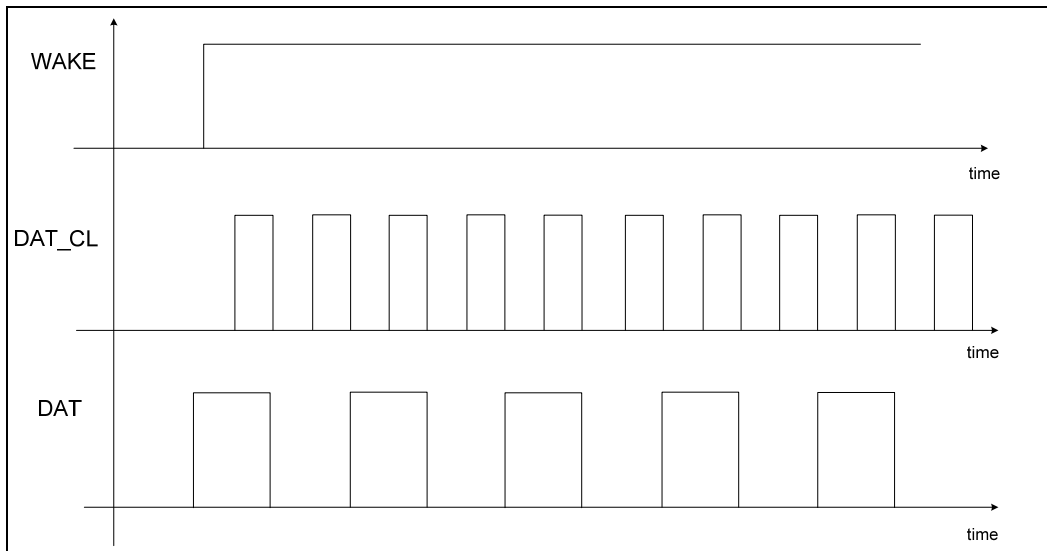

#### 4.7 Channel multiplexing and ON/OFF mode

The test "Range measurements", described in the former paragraph can be redone using the Channel Multiplexing or the ON/OFF mode (using these two modes at the same time is not allowed). In this way the performance is nearly the same, but the current consumption decreases to about 3,5uA.

To activate the "Channel multiplexing" the switch MUX123 has to be set to on (then press SEND), while to activate the "ON/OFF mode" the switch ON/OFF on the RX-board has to be set to on (then press SEND).

#### 4.8 Artificial wakeup

The artificial wakeup produces a 128 us pulse on the WAKE pin even if no action is detected on the input. This test can be done without the presence of the TX-board (TX-board can stay off).

On the **RX-board**:

- Switch the board on
- Set the dipswitch **W\_PATT** and **AUTO\_W** to on and all other switches to off

- Press the button **SEND**

In this way the AS3932 wakes up automatically every 5 sec circa without the presence of a pattern and every time a Pattern1 is detected.

## Contact

Headquarters:

austriamicrosystems AG  
Tobelbaderstrasse 30  
A 8141 Unterpemstaetten, Austria  
T. +43 (0) 3136 500 0  
F. +43 (0) 3136 525 01

[wireless@austriamicrosystems.com](mailto:wireless@austriamicrosystems.com) (Information requests)

<http://www.austriamicrosystems.com/Contact-Ut> (Worldwide locations)

<http://www.austriamicrosystems.com/ICdirect> (Online-shop)

## Copyright

Copyright © 2009 austriamicrosystems. Trademarks registered ®. All rights reserved. The material herein may not be reproduced, adapted, merged, translated, stored, or used without the prior written consent of the copyright owner.

To the best of its knowledge, austriamicrosystems asserts that the information contained in this publication is accurate and correct. austriamicrosystems reserves the right to discontinue production and change specifications and prices, make corrections, modifications, enhancements, improvements and other changes of its products and services at any time without notice.