

ASSEMBLY - VIEW FROM TOP

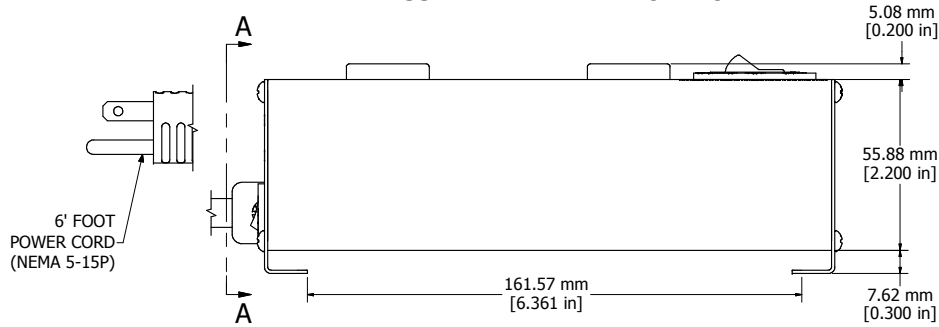

ASSEMBLY - VIEW FROM SIDE

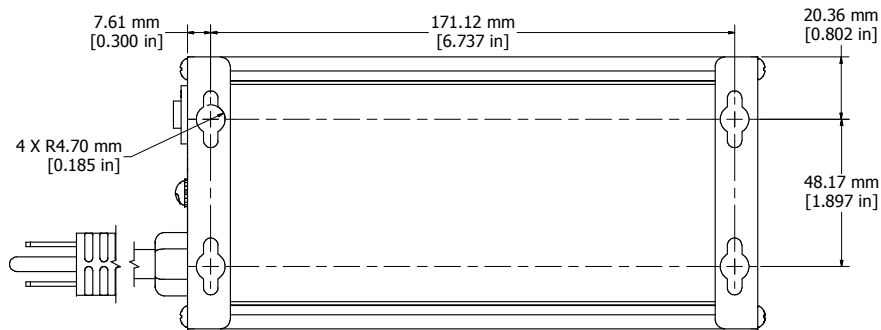

ASSEMBLY - VIEW FROM BOTTOM

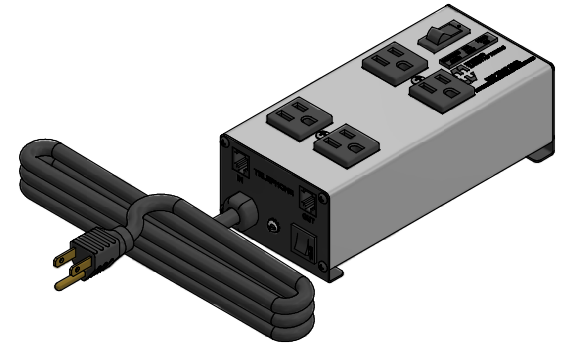

ISOMETRIC VIEW

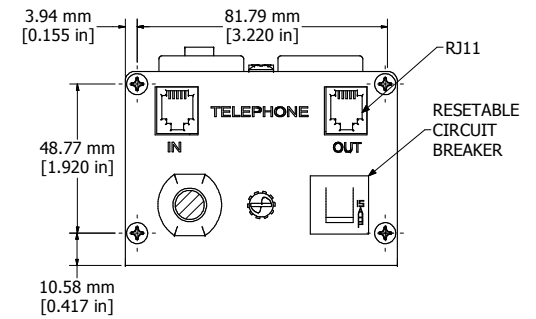

SECTION A-A

ZT2001-4
Finish - Sides - Black Painted Steel
Case - Aluminum Extrusion
Rated - 120 VAC, 60 Hz, 15 Amps
Approvals - CSA Certified Standards C22.2 (No. 21-95, 42-99) & 8-M1986

