

Order Code: 829993STICK

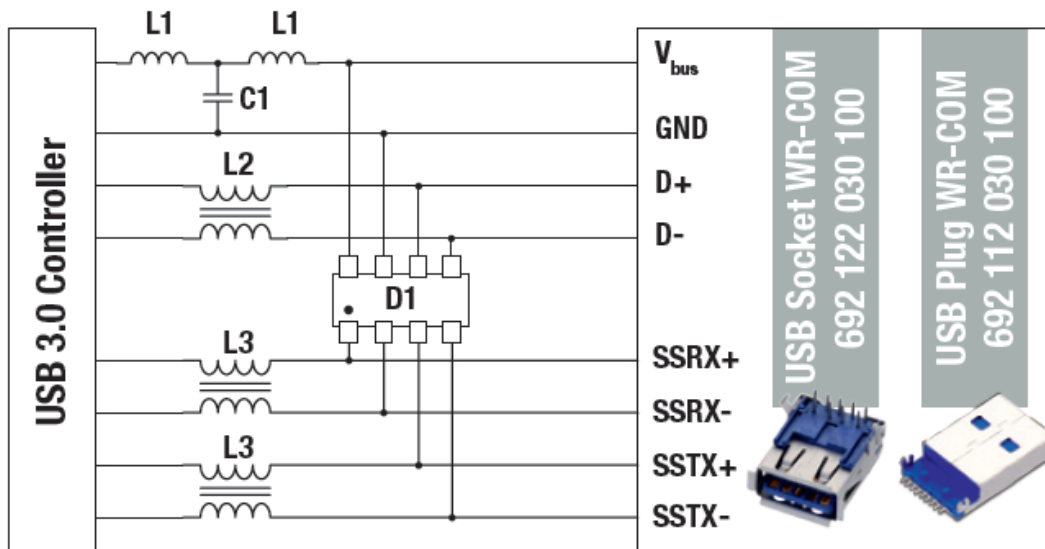

# USB 3.0 EMC Stick with integrated ESD Protection and EMI Filter

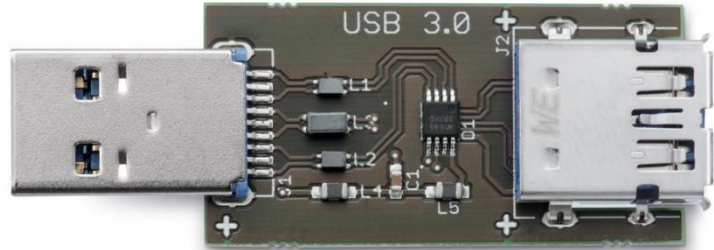

L1 WE-CBF	<b>742 792 040</b>	
	Size: 0805	
	$I_R$ : 2000 mA	
	Z: 600 $\Omega$	

L2 WE-CNSW	<b>744 232 090</b>	
	Size: 1206	
	$I_R$ : 370 mA	
	Z: 90 $\Omega$	

L3 WE-CNSW HF	<b>744 233 670</b>	
	Size: 0805	
	$I_R$ : 320 mA	
	Z: 67 $\Omega$	

D1 WE-TVS	<b>824 016 46</b>	
	Size: MSOP-8L	
	$V_{DC}$ : 5.0 V	
	$C_{Ch}$ : 0,2 pF	

C1 WCAP-CSGP	<b>885 012 206 051</b>	
	Size: 0603	
	C: 680 nF	
	$U_R$ : 16 V	

ONLY FOR DESIGN PURPOSES

# Order Code: 829993STICK

## Electrical Properties

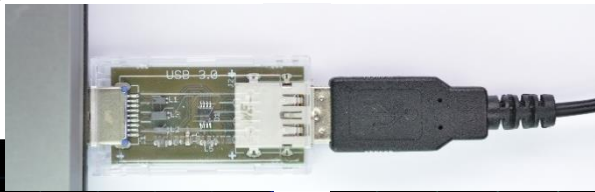
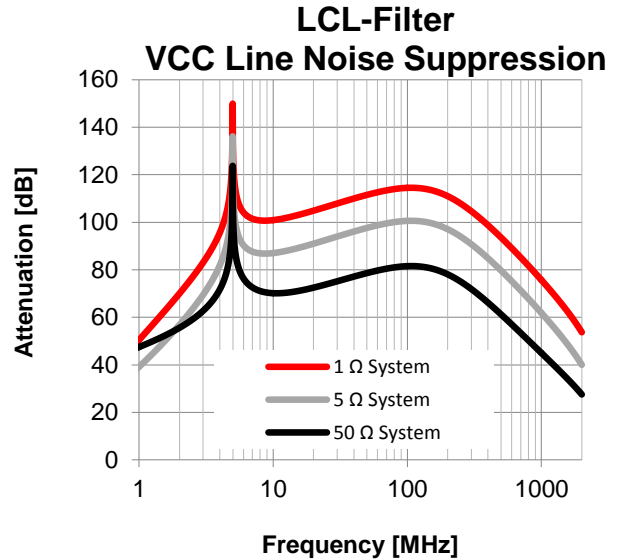
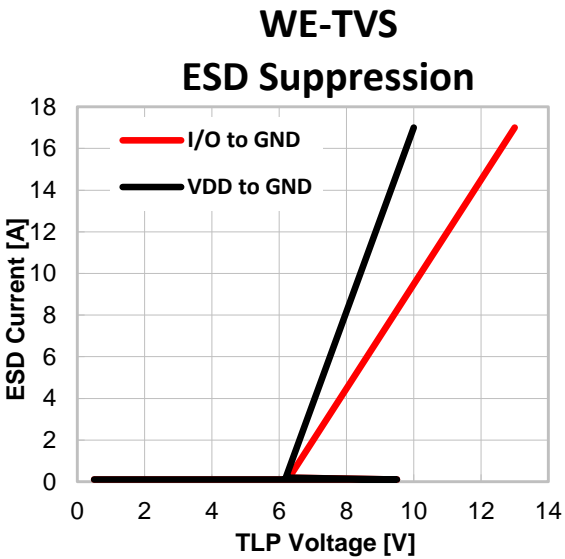
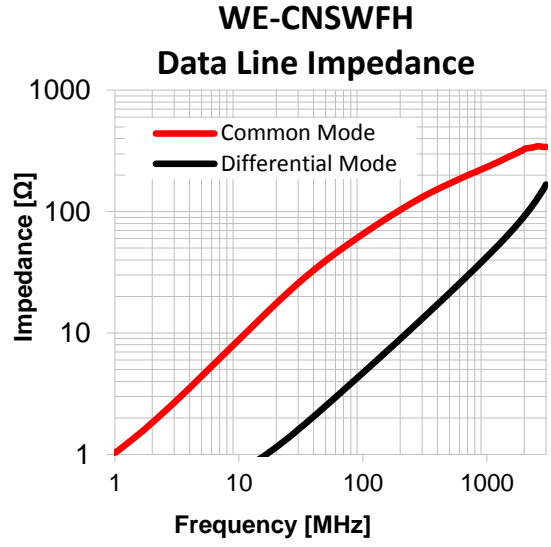
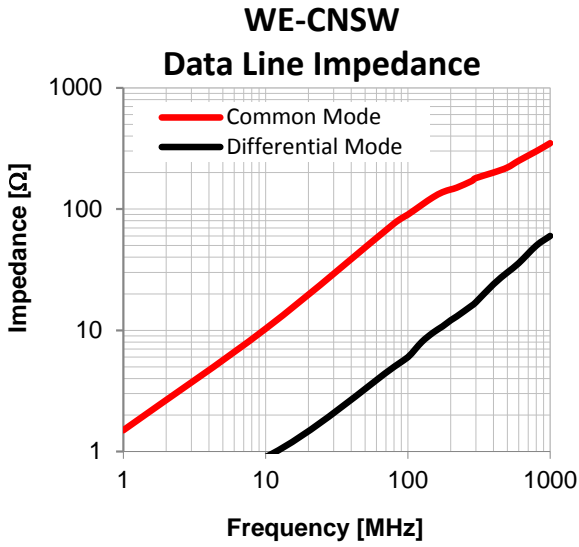

Noise without filter

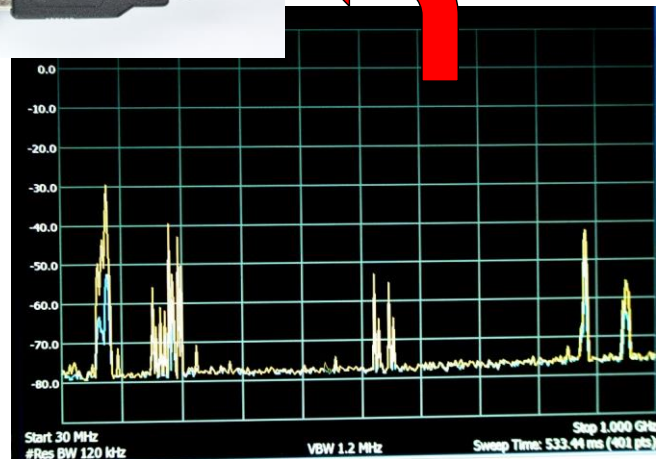

Noise with filter

ONLY FOR DESIGN PURPOSES