

## SMT GaAs HBT MMIC x2 ACTIVE FREQUENCY MULTIPLIER, 9.9 - 12.7 GHz OUTPUT



### Typical Applications

Active Multiplier for X Band Applications:

- OC-192 Clock Recovery
- Microwave Radio & VSAT
- Military Radios, Radar & ECM
- Test Instrumentation

### Features

- Output Power: +4 dBm
- Sub-Harmonic Suppression: 30 dBc
- SSB Phase Noise: -142 dBc/Hz
- Single Supply: 5V@ 46 mA
- 16 Lead 3x3mm SMT Package: 9mm<sup>2</sup>

### Functional Diagram



### General Description

The HMC369LP3 & HMC369LP3E are active miniature x2 frequency multipliers utilizing InGaP GaAs HBT technology in 3x3 mm leadless QFN surface mount packages. Power output is +4 dBm typical from a single +5V supply and varies little vs. input power, temperature and supply voltage. Suppression of undesired fundamental and sub-harmonics is 30 dBc typical with respect to output signal level. The low additive SSB phase noise of -142 dBc/Hz at 100 kHz offset helps the user maintain good system noise performance. The HMC369LP3(E) is ideal for use in LO multiplier chains allowing reduced parts count versus traditional approaches. The HMC369LP3(E) are also useful for OC-192 clock recovery. The application of 10 GBPS data to the input generates a -7 dBm clock tone at the output with spurious signals suppressed by 25 dB.

### Electrical Specifications, $T_A = +25^\circ\text{C}$ , $V_{CC} = 5V$

Parameter	Min.	Typ.	Max.	Min.	Typ.	Max.	Units	
Frequency Range, Input	4.95 - 5.3		5.3 - 6.35					GHz
Frequency Range, Output	9.9 - 10.6		10.6 - 12.7					GHz
Input Power Range	-5		+5	-5		+5	dBm	
Output Power	-1	3		0	4		dBm	
Sub-Harmonic Suppression		30			30		dBc	
Input Return Loss		17			16		dB	
Output Return Loss		5.5			6		dB	
SSB Phase Noise (100 kHz Offset)	Pin= 0 dBm		-142			-142		dBc/Hz
Supply Current (Icc)		46	61		46	61	mA	

# HMC369\* PRODUCT PAGE QUICK LINKS

Last Content Update: 02/23/2017

---

## COMPARABLE PARTS

View a parametric search of comparable parts.

## EVALUATION KITS

- HMC369LP3 Evaluation Board

## DOCUMENTATION

### Data Sheet

- HMC369 Data Sheet

## TOOLS AND SIMULATIONS

- HMC369 S-Parameter

## REFERENCE MATERIALS

### Quality Documentation

- Package/Assembly Qualification Test Report: 16L 3x3mm QFN Package (QTR: 11003 REV: 02)
- Package/Assembly Qualification Test Report: LP2, LP2C, LP3, LP3B, LP3C, LP3D, LP3F, LP3G (QTR: 2014-0364)
- Package/Assembly Qualification Test Report: Plastic Encapsulated QFN (QTR: 05006 REV: 02)
- Semiconductor Qualification Test Report: GaAs HBT-A (QTR: 2013-00228)

## DESIGN RESOURCES

- HMC369 Material Declaration
- PCN-PDN Information
- Quality And Reliability
- Symbols and Footprints

## DISCUSSIONS

View all HMC369 EngineerZone Discussions.

## SAMPLE AND BUY

Visit the product page to see pricing options.

## TECHNICAL SUPPORT

Submit a technical question or find your regional support number.

## DOCUMENT FEEDBACK

Submit feedback for this data sheet.

**SMT GaAs HBT MMIC x2 ACTIVE  
FREQUENCY MULTIPLIER, 9.9 - 12.7 GHz OUTPUT**



**Output Power vs.  
Temperature @ 0 dBm Drive Level**

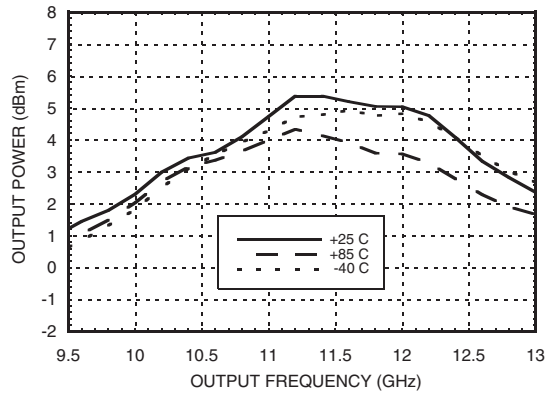

**Output Power vs. Drive Level**

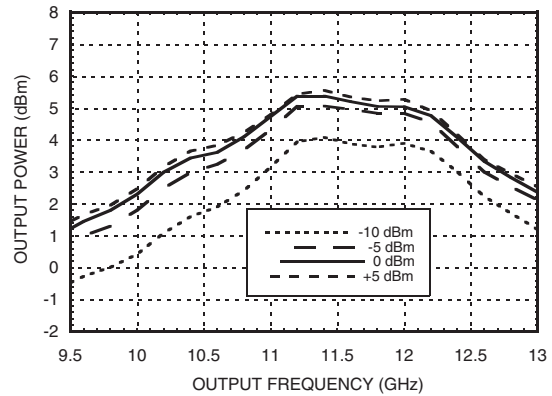

**Output Power vs.  
Supply Voltage @ 0 dBm Drive Level**

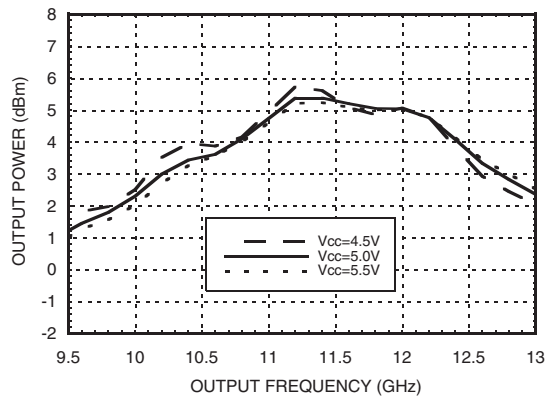

**Input Return Loss vs. Temperature**

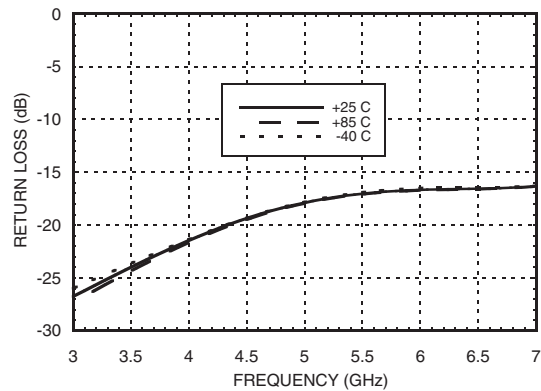

**Output Return Loss vs. Temperature**

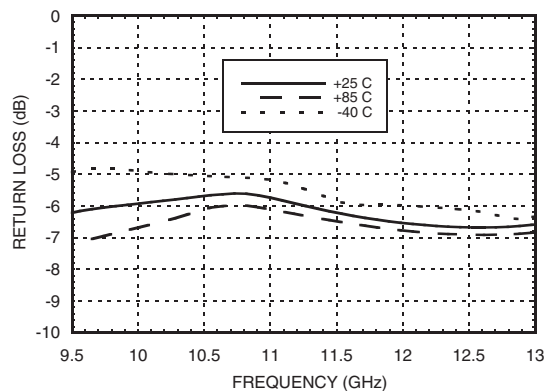

Information furnished by Analog Devices is believed to be accurate and reliable. However, no responsibility is assumed by Analog Devices for its use, nor for any infringements of patents or other rights of third parties that may result from its use. Specifications subject to change without notice. No license is granted by implication or otherwise under any patent or patent rights of Analog Devices. Trademarks and registered trademarks are the property of their respective owners.

For price, delivery, and to place orders: Analog Devices, Inc., One Technology Way, P.O. Box 9106, Norwood, MA 02062-9106 Phone: 781-329-4700 • Order online at [www.analog.com](http://www.analog.com) Application Support: Phone: 1-800-ANALOG-D



**SMT GaAs HBT MMIC x2 ACTIVE  
FREQUENCY MULTIPLIER, 9.9 - 12.7 GHz OUTPUT**

**Output Spectrum**

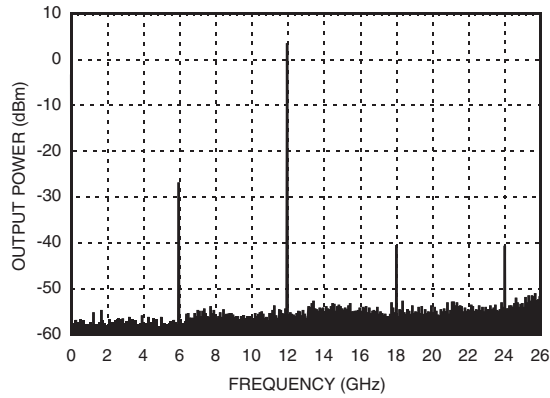

**SSB Phase Noise  
Performance,  $F_{out}$ = 10.66 GHz,  
Input Power= 0 dBm**

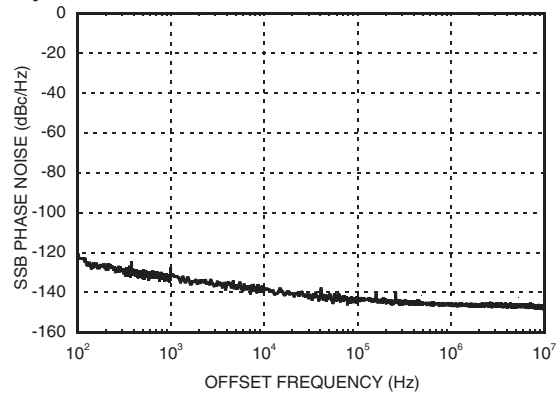

Information furnished by Analog Devices is believed to be accurate and reliable. However, no responsibility is assumed by Analog Devices for its use, nor for any infringements of patents or other rights of third parties that may result from its use. Specifications subject to change without notice. No license is granted by implication or otherwise under any patent or patent rights of Analog Devices. Trademarks and registered trademarks are the property of their respective owners.

For price, delivery, and to place orders: Analog Devices, Inc., One Technology Way, P.O. Box 9106, Norwood, MA 02062-9106 Phone: 781-329-4700 • Order online at [www.analog.com](http://www.analog.com) Application Support: Phone: 1-800-ANALOG-D

## SMT GaAs HBT MMIC x2 ACTIVE FREQUENCY MULTIPLIER, 9.9 - 12.7 GHz OUTPUT



### Absolute Maximum Ratings

RF Input (Vcc = +5V)	+20 dBm
Vcc	+5.5V
Channel Temperature	135 °C
Continuous Pdiss (T=85 °C) (derate 6.8 mW/°C above 85 °C)	440 mW
Thermal Resistance (R <sub>thj</sub> ) (junction to ground paddle)	147.8 °C/W
Storage Temperature	-65 to +150 °C
Operating Temperature	-40 to +85 °C

### Typical Supply Current vs. Vcc

Vcc (V)	Icc (mA)
4.5	45
5.0	46
5.5	47

Note: Multiplier will operate over full voltage range shown above.



ELECTROSTATIC SENSITIVE DEVICE  
OBSERVE HANDLING PRECAUTIONS

### Outline Drawing

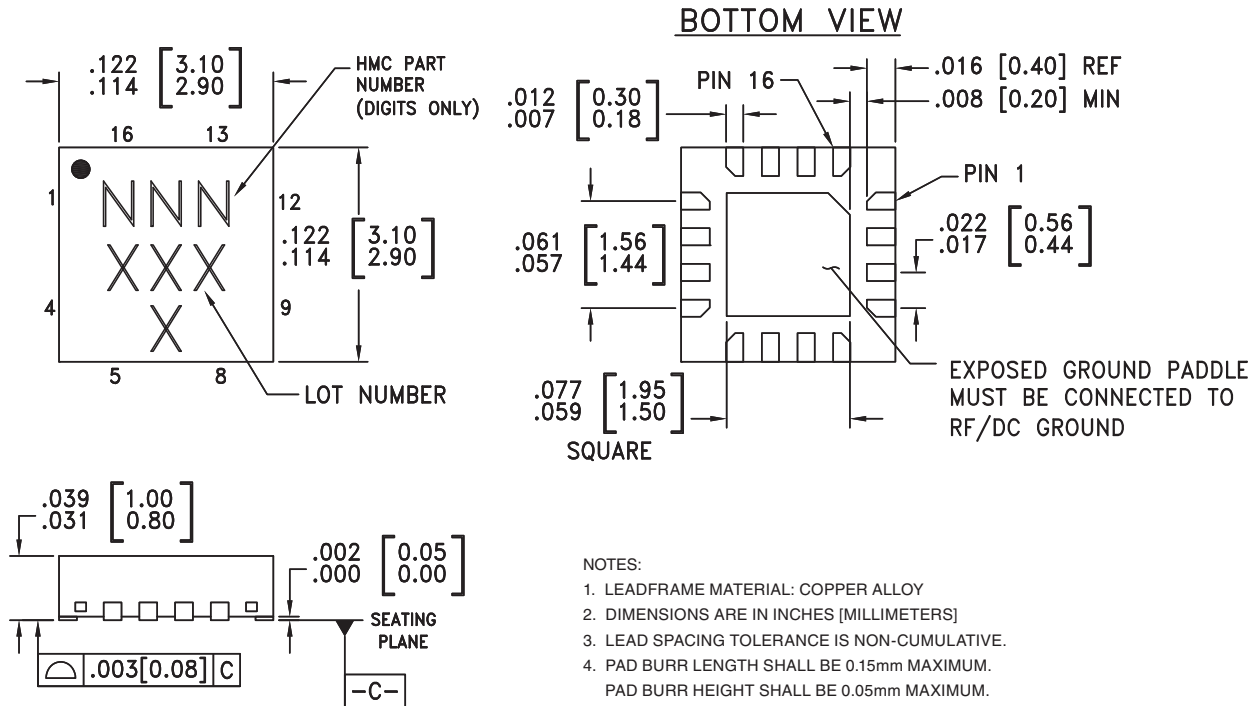

NOTES:

- LEADFRAME MATERIAL: COPPER ALLOY
- DIMENSIONS ARE IN INCHES [MILLIMETERS]
- LEAD SPACING TOLERANCE IS NON-CUMULATIVE.
- PAD BURR LENGTH SHALL BE 0.15mm MAXIMUM.  
PAD BURR HEIGHT SHALL BE 0.05mm MAXIMUM.
- PACKAGE WARP SHALL NOT EXCEED 0.05mm.
- ALL GROUND LEADS AND GROUND PADDLE MUST BE SOLDERED TO PCB RF GROUND.
- REFER TO HITTITE APPLICATION NOTE FOR SUGGESTED LAND PATTERN.

### Package Information

Part Number	Package Body Material	Lead Finish	MSL Rating	Package Marking <sup>[3]</sup>
HMC369LP3	Low Stress Injection Molded Plastic	Sn/Pb Solder	MSL1 <sup>[1]</sup>	369 XXXX
HMC369LP3E	RoHS-compliant Low Stress Injection Molded Plastic	100% matte Sn	MSL1 <sup>[2]</sup>	369 XXXX

[1] Max peak reflow temperature of 235 °C

[2] Max peak reflow temperature of 260 °C



[3] 4-Digit lot number XXXX

Information furnished by Analog Devices is believed to be accurate and reliable. However, no responsibility is assumed by Analog Devices for its use, nor for any infringements of patents or other rights of third parties that may result from its use. Specifications subject to change without notice. No license is granted by implication or otherwise under any patent or patent rights of Analog Devices. Trademarks and registered trademarks are the property of their respective owners.

For price, delivery, and to place orders: Analog Devices, Inc., One Technology Way, P.O. Box 9106, Norwood, MA 02062-9106  
Phone: 781-329-4700 • Order online at [www.analog.com](http://www.analog.com)  
Application Support: Phone: 1-800-ANALOG-D

**SMT GaAs HBT MMIC x2 ACTIVE  
FREQUENCY MULTIPLIER, 9.9 - 12.7 GHz OUTPUT**

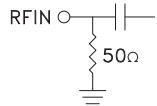
**Pin Description**

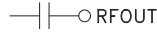
Pin Number	Function	Description	Interface Schematic
1, 2, 5 - 8, 11 - 13, 15, 16	N/C	The pins are not connected internally; however, all data shown herein was measured with these pins connected to RF/DC ground externally.	
3	RFIN	RF input needs to be DC blocked only if there is an external DC voltage applied to RFIN.	
4, 9	GND	All ground leads and ground paddle must be soldered to PCB RF/DC ground.	
10	RFOUT	Multiplied Output. AC coupled. No external DC blocks necessary.	
14	Vcc	Supply voltage 5V ± 0.5V.	



**Evaluation PCB**

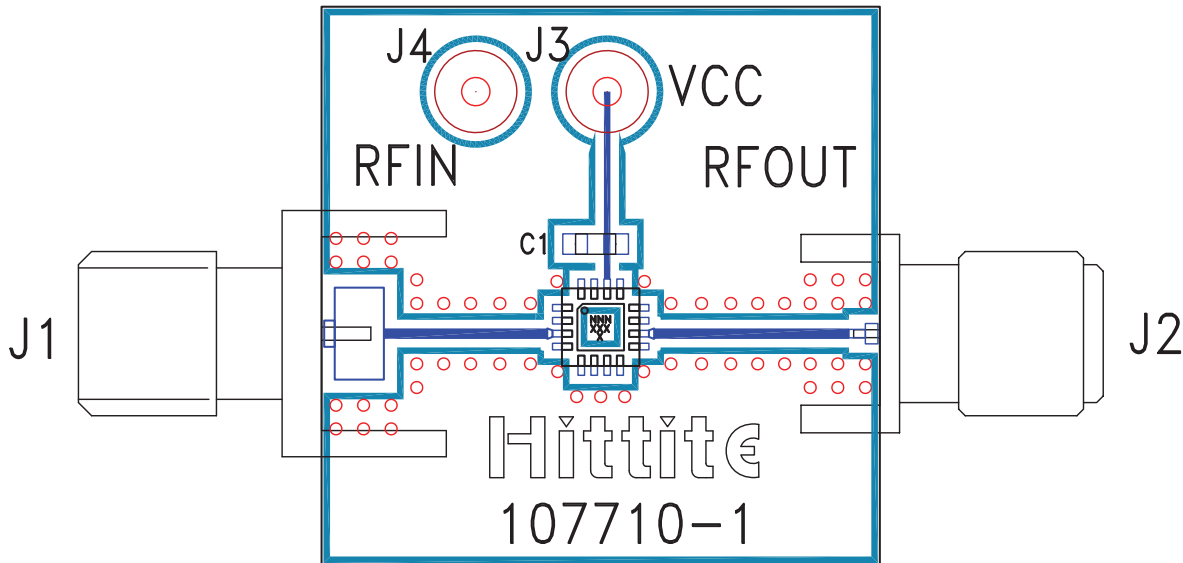

**List of Materials for Evaluation PCB 107712 [1]**

Item	Description
J1, J2	PCB Mount SMA Connector
J3, J4	DC Pin
C1	0.01 $\mu$ F Capacitor, 0603 Pkg.
U1	HMC369LP3 / HMC369LP3E x2 Active Multiplier
PCB [2]	107710 Eval Board

[1] Reference this number when ordering complete evaluation PCB

[2] Circuit Board Material: Rogers 4350

The circuit board used in the final application should be generated with proper RF circuit design techniques. Signal lines should have 50 ohm impedance while the package ground leads and exposed paddle should be connected directly to the ground plane similar to that shown. The evaluation circuit board shown is available from Hittite upon request.