

Approved	Checked	Designed	DEVELOPMENT SPECIFICATION				
<i>T. Akhuta</i>	<i>M. Ito</i>	<i>T. Onizuka</i>		<u>P/N: LNJ651C4WRA</u>		18	

DEVELOPMENT SPECIFICATION

PRODUCT NUMBER LNJ651C4WRA

PRODUCT NAME J type chip LED

PUBLISH Sep. 1. 2000

KAGOSHIMA MATSUSHITA ELECTRONICS CO., LTD.

Development Center

Sep. 1. 2000			

Approved	Checked	Designed	DEVELOPMENT SPECIFICATION			
<i>T. Sheda</i>	<i>M. H. I.</i>	<i>T. Onizuka</i>	P/N: <u>LNJ 6 5 1 C 4 W R A</u>		1 8	2

1. Scope of application

This specification applies to "LNJ651C4WRA" of J type chip LED series.

2. Ratings and characteristics

Refer to attached development specification.

3. Overview

Refer to attached drawing of overview.

4. Packing

Refer to attached packing specification.

※However if the number of products does not reach a package unit or delivery containing apparently short number of products is required packing may differ.

5. Attached packing specification

Name of product, quantity, serial tight number should be identified on the Individual package.

0 9 September, 2000



January February October November December
 1 2 O N D

*Only on the packing case tight number can be contained.

6. External inspection

Those defects such as crack, breakage, scar and void which affect optical and Mechanical characteristics should be failed.

Sep. 1. 2000			

Approved	Checked	Designed	DEVELOPMENT SPECIFICATION			
<i>T. Akeda</i>	<i>M. Iri</i>	<i>T. Onizuka</i>	<u>P/N : LNJ 6 5 1 C 4 W R A</u>		1 8	3

7. Others

7-1 Caution on use

Refer to Handling note.

7-2 Caution on design

- 1 Connect the current control resistor in the circuit so it operates within ratings.
- 2 An instant reverse voltage (reverse current) when turning on/off the circuit should be avoided.
- 3 Mount the chip in longitudinal direction of the board so that stress on product is decreased.

[NOTE]

- We recommend the LED be placed on the PC Board as shown in diagram A.
- If the LED must be placed on the PC Board as shown in diagram B, special Care should be taken to insure that the LED is not effected by bend of the PC Board after the soldering process.

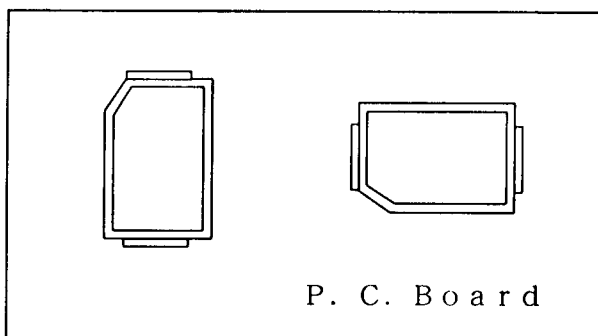

(A)

(B)

7-3 UL standard

Since epoxy resin which is superior in optical characteristics is adopted for the LED, UL standard is not gained.

7-4 Doubt

If any doubt arises as to this specification, it should be solved by mutual consultation.

7-5 Although it is ensured that products satisfying every item in this specification are delivered, for installation, life on practical use and other quality, please examine the products yourself completely.

7-6 These parts are intended to be used for general commercial applications. Please contact your local Panasonic sales office prior to these components being used in applications where failure of a component could lead to serious risk of personal injury or property damage.

Sep. 1. 2000			

Approved	Checked	Designed	DEVELOPMENT SPECIFICATION			
<i>T. Akeda</i>	<i>M. Ni</i>	<i>T. Oniyama</i>	P/N: LN J 6 5 1 C 4 W R A			
				1 8		4

T Y P E	Pure Green Light Emitting Diode					
A P P L I C A T I O N	Indicators					
M A T E R I A L	GaN					
O U T L I N E	Attached					

A B S O L U T E	P	*1 I _{FP}	I _{FDC}	V _R	Topr	Tstg
M A X I M U M	40	50	10	5	-25~+80	-30~+85
R A T I N G S	mW	mA	mA	V	°C	°C

C O N D I T I O N	T _a = 25 ± 3 °C					
-------------------	----------------------------	--	--	--	--	--

T e s t S p e c i f i c a t i o n						
I t e m	Symbol	C o n d i t i o n	Typ	Limit		Unit
				Min	Max	
Forward Voltage	V _F	I _F = 5 mA	3.0		3.7	V
Reverse Leakage Current	I _R	V _R = 5 V			10	μ A
Luminous Intensity *2	I _O	I _F = 5 mA DC	60	32		mcd
Peak Emission Wavelength	λ _p	I _F = 5 mA DC	525			nm
Spectral Line Half Width	Δλ	I _F = 5 mA DC	45			nm

*1. The Condition of pulse current I_{FP} is lms pulse width, 10 % duty cycle.
 · Please contact the Panasonic local office if you design at low current (below 1 mA DC) or pulse current operation and have any questions.
 *2. Classification of luminous intensity
 Tolerance of luminous intensity ±20%.

Condition ; I_F = 5 mA

Rank	Luminous Intensity (m c d)
1	32 ~ 48
2	48 ~ 72
3	72 ~ 108
4	108 ~ 162
5	162 ~ 243

NOTE

- ★1. Soldering conditions.
Refer to Handling note.
- ★2. Care should be taken that soldering is done within 3-days after opening the dry package and reel.
- ★3. Package: Clear type.
- ★4. The attention on circuitry

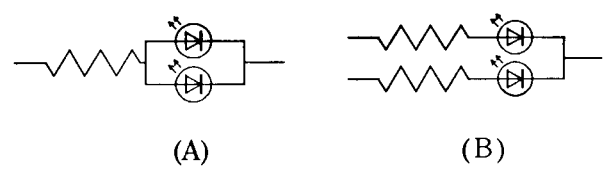

(A) The difference of brightness between the LED could be found due to the V_F characteristics of each LED.
 (B) Recommended circuit.

Sep. 1. 2000		

Approved	Checked	Designed
T. Akheda	M. Ni	T. Onozuka

DEVELOPMENT SPECIFICATION

P/N: LNJ651C4WRA

18

5

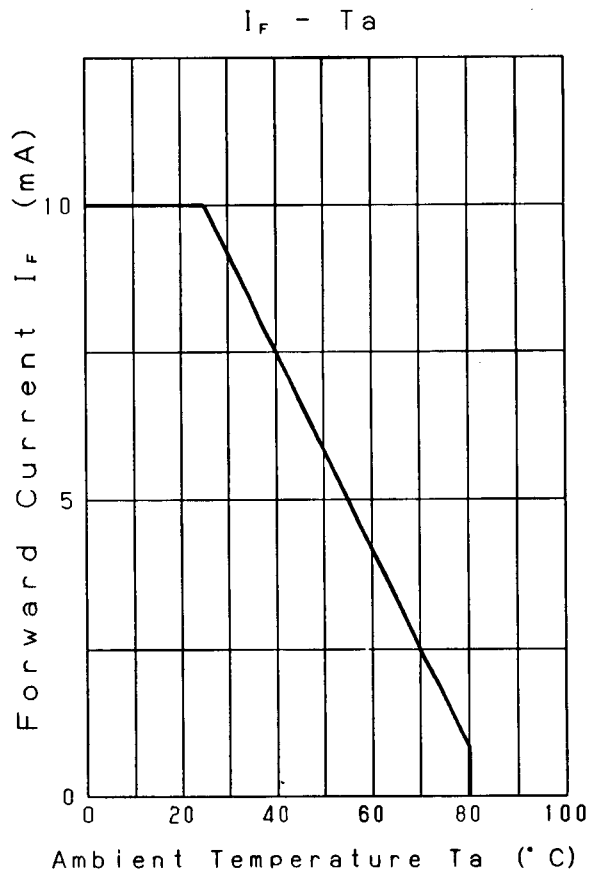
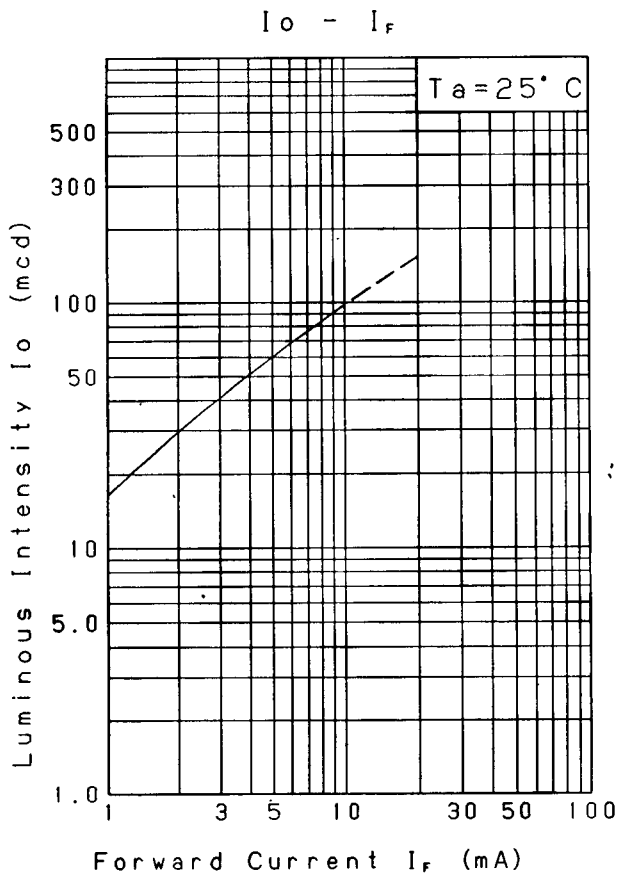
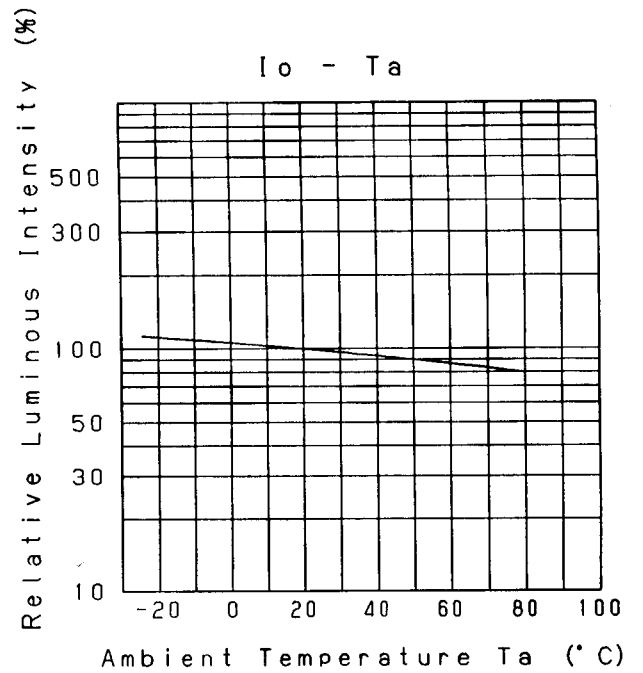
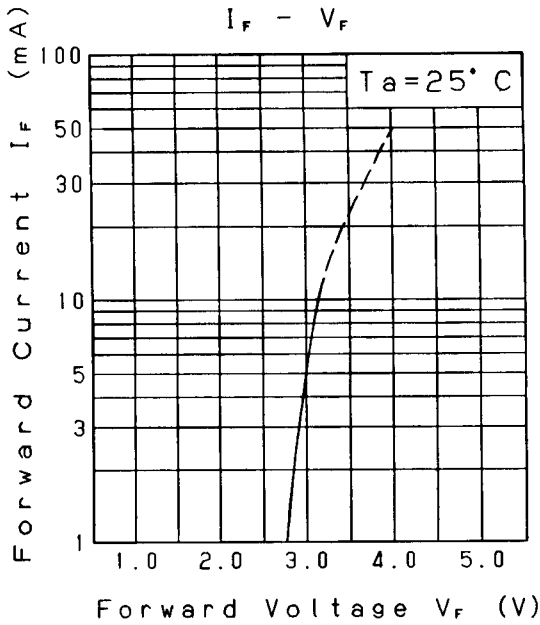

Sep. 1. 2000

Approved	Checked	Designed	DEVELOPMENT SPECIFICATION		
<i>T. Kudo</i>	<i>M. Ni</i>	<i>T. Mizusaka</i>	P/N:LNJ651C4WRA		
			18		6

Relative Luminous Intensity
Wavelength Characteristics

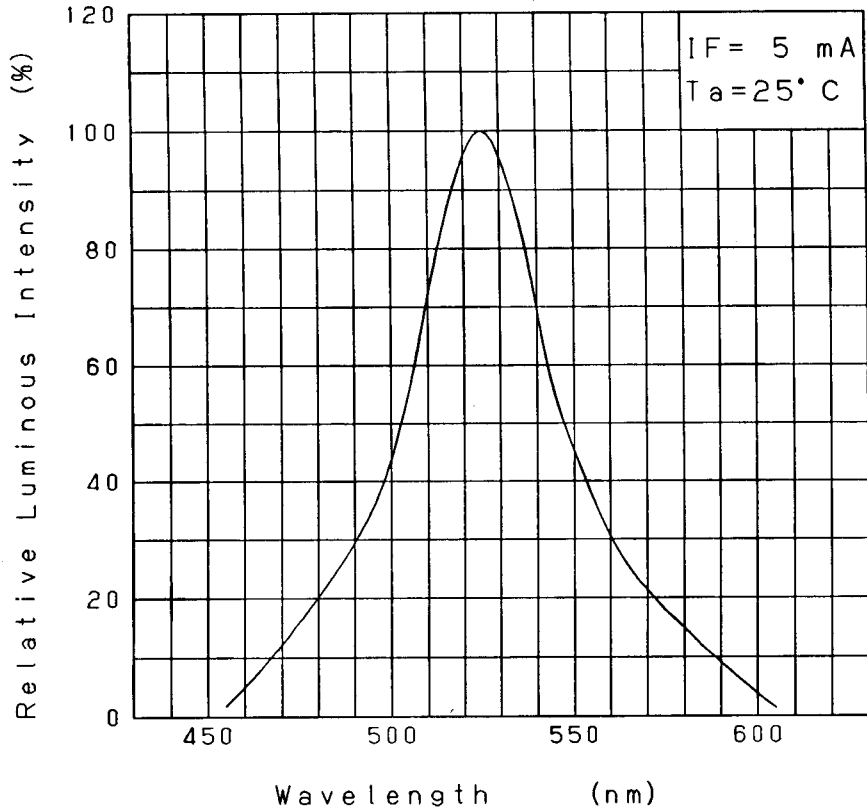

Directive Characteristics

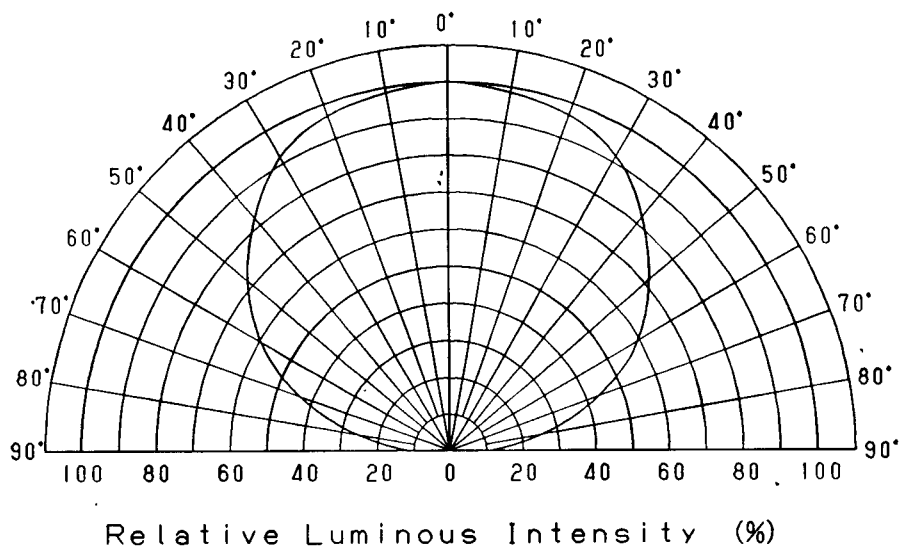

Sep. 1. 2000			

Approved	Checked	Designed	DEVELOPMENT SPECIFICATION (OUTLINE) P/N: LNJ651C4WRA			
T. Kikuchi	M. Ni	T. Yamaguchi				

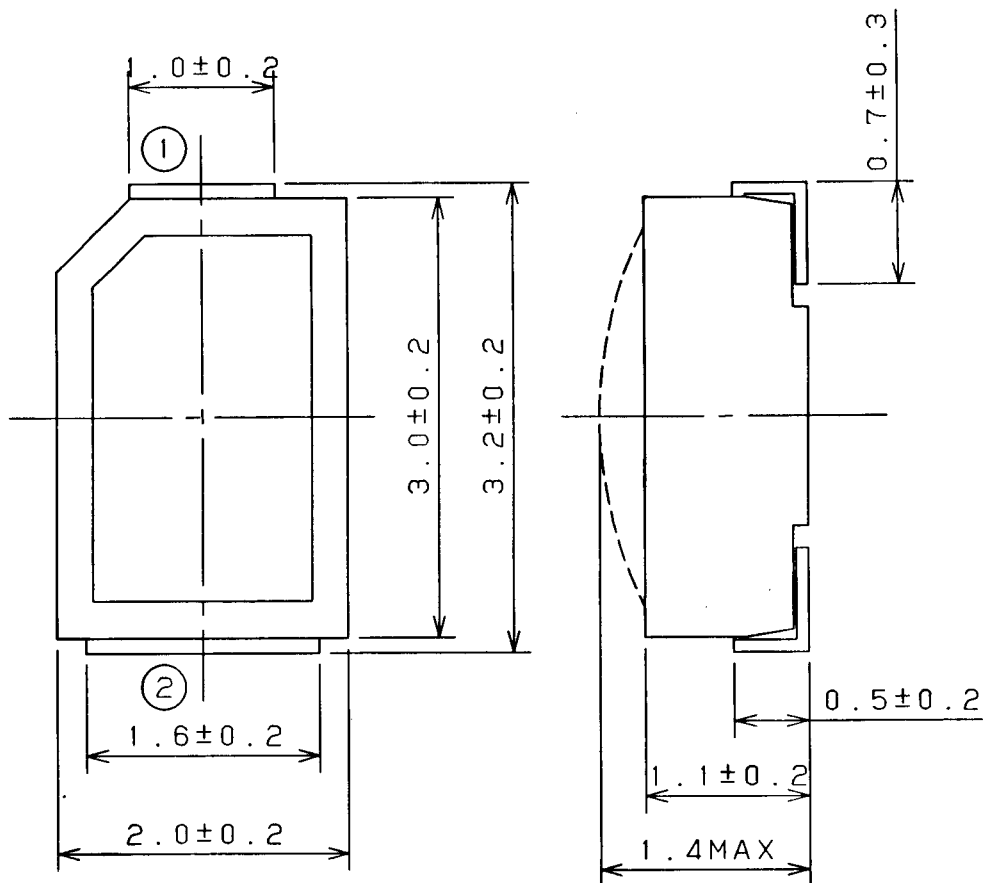

- ① ANODE
- ② CATHODE

(NOTE)
 1. Unit: mm
 2. The terminals have been dip soldered.

Sep. 1. 2000		

Approved	Checked	Designed	DEVELOPMENT SPECIFICATION			
T. Akeda	M. W.	T. Mizushima		P/N: LNJ651C4WRA	18	

~Taping Specifications~

1. Scope of application

This specification regulates packing and related matters as to taping delivery of chip type visible LED (called chip LED hereinafter).

Refer to the individual product specification for items not contained herein such as electric characteristics.

2. Structure of taping

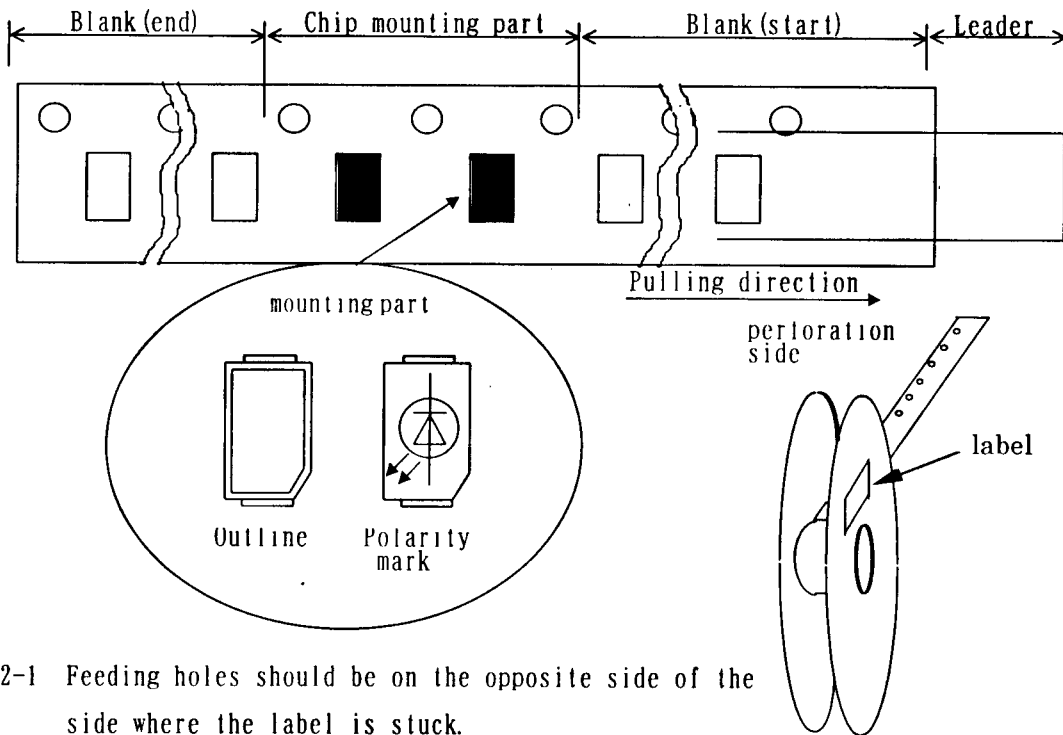

2-1 Feeding holes should be on the opposite side of the side where the label is stuck.

2-2 Chip LED taping direction.

Feeding holes' side is catholic side;

The top of a Chip LED faces the cover tape.

2-3 Apply adhesive tape on the leader which should be 200 mm or longer.

2-4 Keep more than 10 emboss blanks at front and end of the taping.

Product name indication

Example LNJ651C4W RA

Taping specification
Chip LED product No.

Sep. 1. 2000			
--------------	--	--	--

Approved	Checked	Designed	DEVELOPMENT SPECIFICATION	18	9
T. Akeda	M. Ichi	T. Onizuka			

~Taping Specifications~

3. Mechanical strength and treatment

3-1 Exfoliation strength of the cover tape should be 0.19~0.69 N.

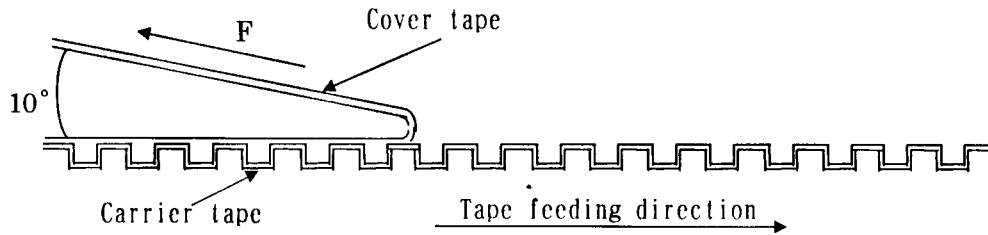

3-2 Tape bending strength

Tape should not be deformed by bending with a radius of 15 mm.

3-3 Removal of product

Chip LED should not be adhered to the cover tape.

3-4 Storing and leaving the tape aside

The tape should be stored under 40°C of temperature and under 60 % of humidity.

Do not expose the tape to direct sunlight.

3-5 Defective percentage of enclosed

The product which was enclosed in reverse direction or with back side up should be counted as 0 piece/reel.

The number of dropped parts should be 0.1 % of entire number of parts or 1 piece, whichever larger. There should be no continuous dropping however, total number has to remain intact.

3-6 There should be no tape joint.

Sep. 1. 2000		

Approved	Checked	Designed	DEVELOPMENT SPECIFICATION			
T. Akada	M. Ichi	T. Onizuka		P/N : LN J 6 5 1 C 4 W R A	1 8	

~Packaging Specifications~

4. Packing unit and label position

4-1 A reel of 3000 LED's is basic unit.

4-2 Both the reel and silica gel are contained in the PET bag.

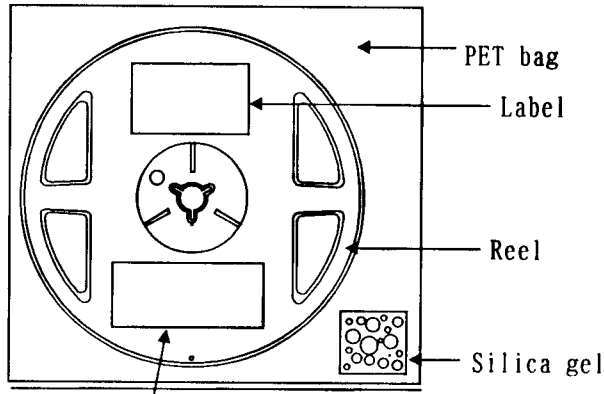

Notice label (affixed to Shield bag)

*Rank can not be mixed within a packing.

4-3 Packing(inner)

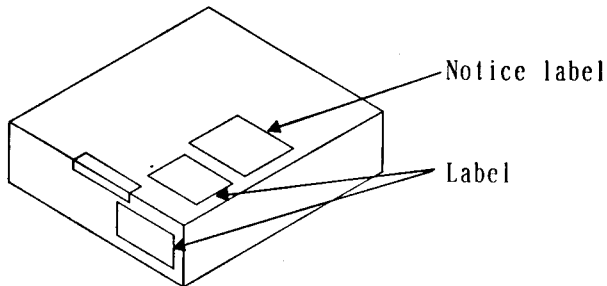

*Rank can be mixed within a packing.

4-4 Packing(outer)

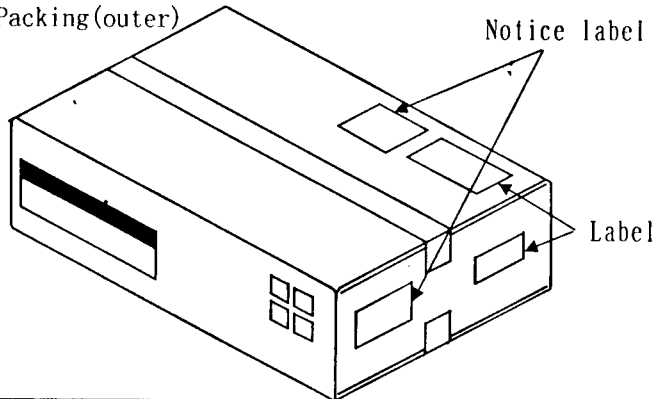

*Rank can be mixed within a packing.

Sep. 1. 2000			

Approved	Checked	Designed	DEVELOPMENT SPECIFICATION			
T. Akada	M. Ichi	T. Onizuka	P/N: LNJ 6 5 1 C 4 W R A			
				1 8		1 1

~ Internal use Label Items ~

1. Packing Division

- Reel : 3,000 pieces
- Packing (inner) : 12,000 pieces
- Packing (outer) : 24,000 pieces

2. CONTENTS

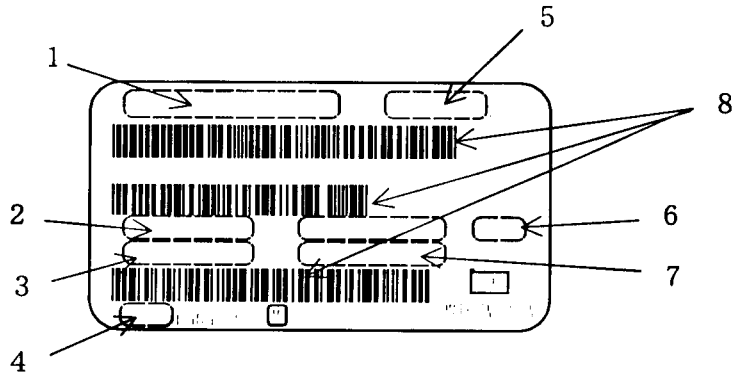

- | | |
|----------------------------|----------------------|
| 1. Customer code | 5. Quantity |
| 2. Luminous intensity rank | 6. Warehouse control |
| 3. Date code | 7. Product number |
| 4. Date of label printing | 8. Bar code symbol |

• Example of date code

Date code of "09" indicates September, 2000 (Date of taping and case packing).

3. Indication method (Notice label)

〈注意〉
 本製品は、静電気に対して感度の高い部品であり、その取り扱いには充分な注意が必要となります。特に、LEDの絶対最大定格を超えるような過電圧等が入った場合、そのエネルギーによってLEDにダメージを与えます。つきましてはLEDの取り扱いに注意し、万全な静電気・サージ対策をおとり下さい。

〈NOTICE〉
 This LED is sensitive to static electricity and care should be fully taken in handling it. Particularly, when an overvoltage is applied, which exceeds the absolute maximum rating of the LED, its energy damages the LED. Therefore, take utmost proactive measures against static electricity and surge as to building an assembly line and handling the LED halfway the process.



ATTENTION
 OBSERVE PRECAUTION
 FOR HANDLING
 ELECTRO-STATIC
 SENSITIVE
 DEVICES
 静電気注意

PCS		

Made in Japan

Sep. 1. 2000			

Approved	Checked	Designed
<i>T. Sheda</i>	<i>M. W.</i>	<i>T. Onizuka</i>

DEVELOPMENT SPECIFICATION

P/N: LNJ651C4WRA

18

12

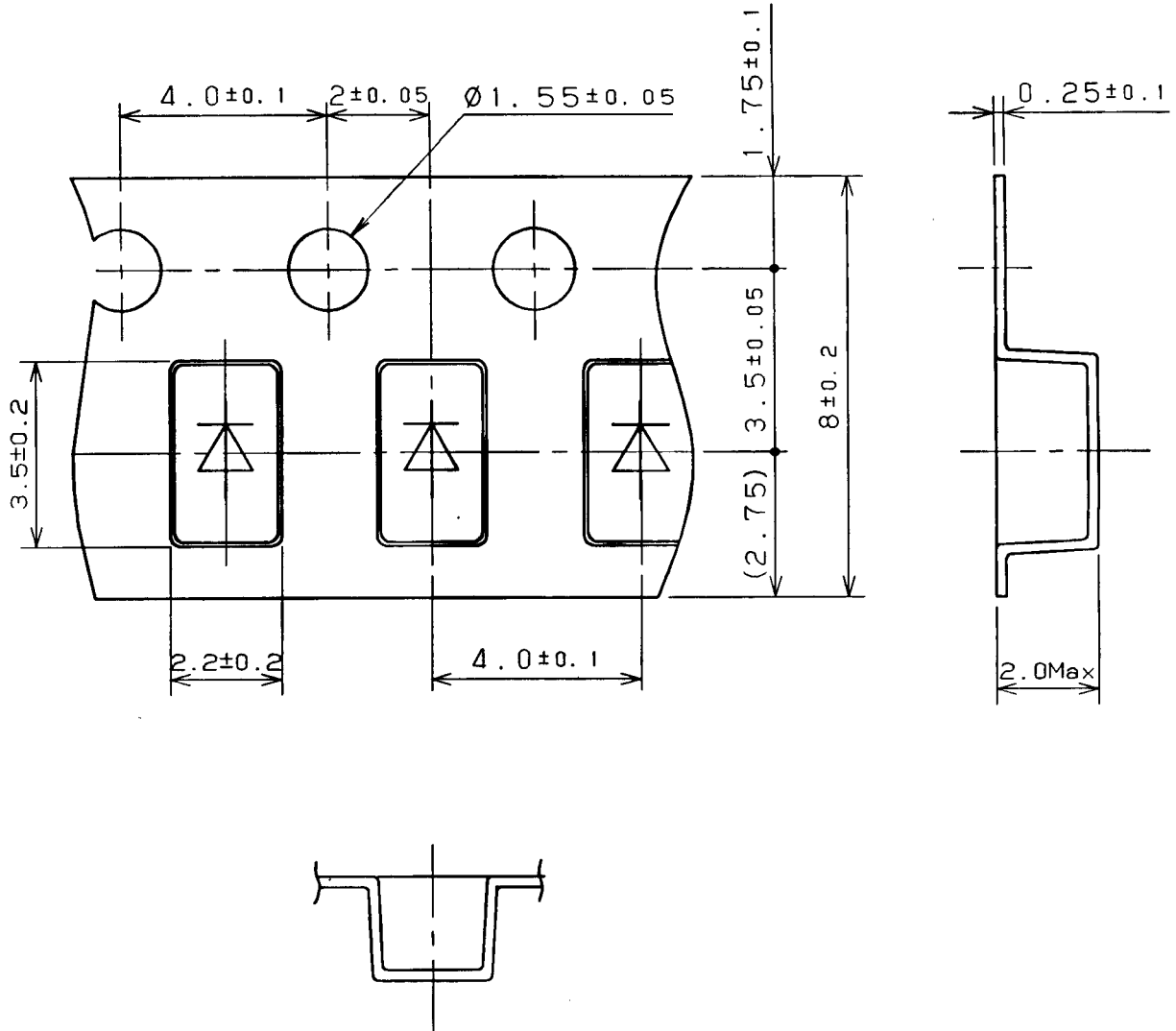

(NOTE)

- 1) Unless otherwise specified R of the corner is max. 0.3.
- 2) Allowance of accumulated pitch of feeding holes is ± 0.3 per 50 pitches.
- 3) Material is conductive grade.

Sep. 1. 2000

Approved	Checked	Designed	DEVELOPMENT SPECIFICATION		
<i>T. Kudo</i>	<i>M. W.</i>	<i>T. Onizuka</i>	P/N: LNJ651C4WRA		
			18		13

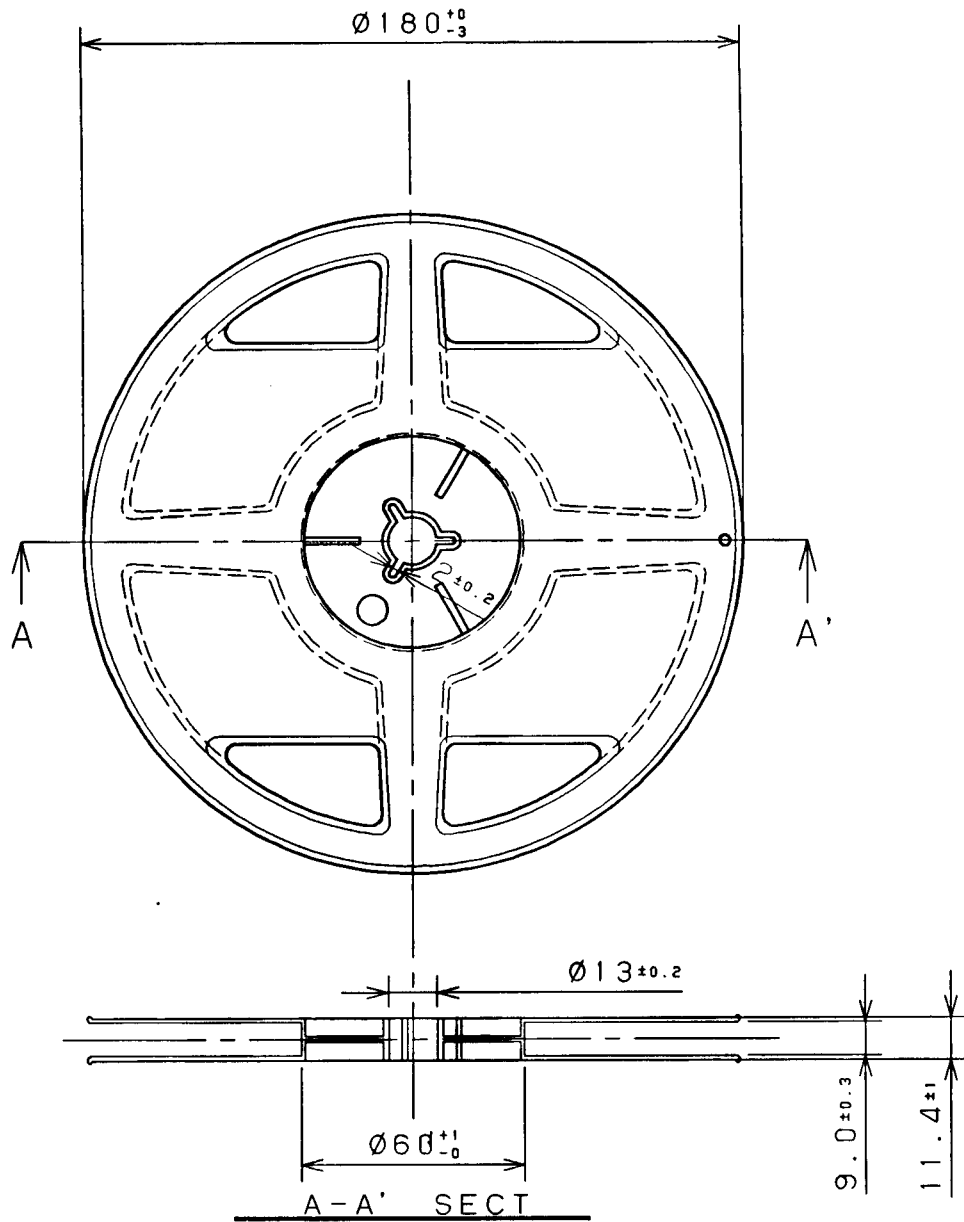

NOTE
 1) This part is application of EIAJ ETX-7001.
 2) Unit: mm

Sep. 1. 2000			
--------------	--	--	--

Approved	Checked	Designed	DEVELOPMENT SPECIFICATION			
<i>T. Akeda</i>	<i>M. W.</i>	<i>T. Onizuka</i>	P/N : <u>LNJ 6 5 1 C 4 W R A</u>		1 8	1 4

~ Handling note ~

1. Storage

To prevent humid absorption while transporting or storing the product. Humidity proof packing is made using a PET bag. Inside this packing contained a silica gel to indicate rate of humidity. As it gets moistened, the color changes from blue to pink.

Because of the humidity proof packing, it is recommended the product be Mounted immediately after unpacking. To store after unpacking, use a dry Box or seal the packing again using a tape (with silica gel).

* Recommended use after unpacking : 3 days

The product left unpacked may have its characteristics deteriorated.

* If the epoxy in the LED is exposed to humidity it can be corrected by baking before soldering.

(1) After placement and before soldering : 115°C × 2~15 h (within twice)

(2) In carrier (before placement) : 60°C × 12~24 h

* Storage limit of product

It is recommended the product be used within a year.

2. Washing

If organic solvent such as trichlene(trichloroethylene) or acetone Adheres to the surface, the condition of the surface may change.

As a rule do not wash the organic solvent.

* For supersonic washing, make sure the condition completely beforehand.

3. Flux to be used

Use isopropyl alcohol (JISK8839) solvent of rosin (JISK5902) or the equal.

Sep. 1. 2000			

Approved	Checked	Designed	DEVELOPMENT SPECIFICATION			
<i>T. Akeda</i>	<i>M. Iijima</i>	<i>T. Onizuka</i>	P/N : LNJ 6 5 1 C 4 WRA		1 8	1 5

~ Handling note ~

4. Reflow soldering

Use the reflow soldering in the following condition.

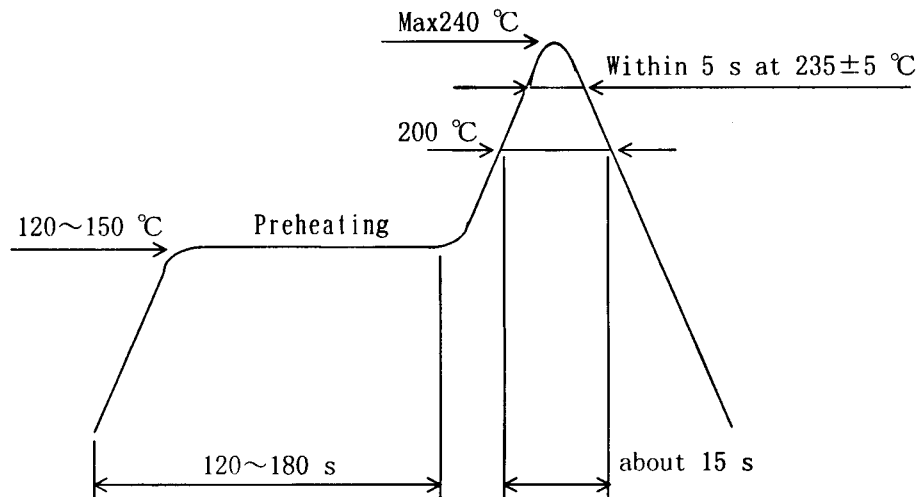

* This should be a profile on the PC board surface. The temperature on the product surface should be 230 °C or less.

5. Condition of product keeping

- If you keep products in carrier for long time after opening, you should keep them in desiccant box or seal up Shield bag with silica gel.
- You should keep the products in following condition.

Temp : 40 °C humidity : 60 % or less

6. Manual soldering

- Keep the temperature on the edge of iron at 350 °C and apply for 3 s.
If the temperature become higher, apply in a shorter time (1s par 10 °C)
- It is recommended using a iron with a temperature control.
- In manual soldering, take care not to damage the package especially terminals or resin. (Do not give stress to the product when soldering.)
- Do not use again it you remove the soldered product.

Sep. 1. 2000			

Approved	Checked	Designed	DEVELOPMENT SPECIFICATION				
T. Akada	H. Hori	T. Onizuka		<u>P/N: LN J 6 5 1 C 4 W R A</u>		1 8	

~ Handling note ~

7. Automatic placement

These products are available for automatic placement machines. However, Demand on structure and performance of these devices, you should pay attentions as the following.

- (1) Though we've performed anti-static operation on these devices, static electricity may be occurred by dry atmosphere, and may cause to stick products on cover tapes. Please study to control humidity, and to perform anti-static measures.
- (2) If a successful placement is not secured on your systems, you may study the following subjects.

Inside diameter of tool	Especially for round shaped tool, please choose it not to stick Out the LED's lens area. (Example : 1005 type tool is suitable for 1608 LED's.)
Shape of tool	For a particular tool ("asterisk" type etc.), please study a location and size of tool not to incline parts, in placing.
Height of tool	Please adjust a height of tool as minus from top of the face of tape guide.
Position in absorption	Please adjust a absorb position as a center of device as possible.
Vibration in placing	Please maintain your machines to successful placement, like as adjustiug placing speed, tensions in winding and feeding tapes.
Pin push up system	"Pin push up system" is suitable only for products prepared pin-hole on bottom of embossed tape, but not for others.

8. Strength of products

In these products, we use epoxy resin for molding LED devices. The resin is softened by heating, and strength of resin becomes weak, different from that of other SMD's. So you should keep products from shocking on resin side, especially soldering process And using by soldering irons.

And after soldering process, please avoid shocking directly on resin side, Such as in the following cases, handling PCB's, piling them up, and putting them in magazines.

Sep. 1. 2000			

Approved	Checked	Designed	DEVELOPMENT SPECIFICATION			
<i>T. Akeda</i>	<i>M. Hōjō</i>	<i>T. Onizuka</i>	P/N: <u>LNJ 6 5 1 C 4 WRA</u>		1 8	1 7

~Requests and Cautions for Use~

Static electricity

A GaN LED is sensitive to static electricity and care should be fully taken in handling it. Particularly, when an overvoltage is applied, which exceeds the absolute maximum rating of the GaN LED, its energy damages the LED. Therefore, take utmost proactive measures against static electricity and surge as to building an assembly line and handling the LED halfway the process.

- (1) Check the entire drive circuit including the power source. For example, a surge current, etc., generated at power-on/off must not exceed the absolute maximum rating of the LED. Also, insert an appropriate protective circuit into the LED drive circuit.

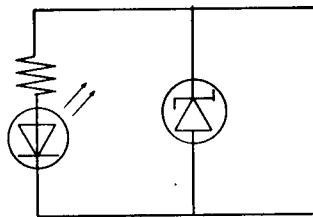

We recommend to use Zener diode to Protect LEDs as shown in the recommended circuit specifically for the GaN blue and green LED.

- (2) Beware of destruction by static electricity in handling the LED. As proactive measures against static electricity, it is effective to earth your body (via 1 MΩ), spread conductive mat on the floor, wear semiconductive work uniform and shoes, and use smiconductive containers. Also, be sure to earth the nose of a soldering iron. It is recommended to use an ionizer, etc., in the facility or enviroment where static electricity may be generated easily.

Sep. 1. 2000			

Approved	Checked	Designed	DEVELOPMENT SPECIFICATION				
<i>T. Shoda</i>	<i>M. Ito</i>	<i>T. Mizukawa</i>		<u>P/N : LN J 6 5 1 C 4 W R A</u>		1 8	

~Requests and Cautions for Use~

1. An export permit needs to be obtained from the competent authorities of the Japanese Government if any of the products or technologies described in this Document and controlled under the "Foreign Exchange and Foreign Trade Control Law" is to be exported or taken out of Japan.
2. The technical information described in this document is limited to showing representative characteristics and applied circuit examples of the products. It does not constitute the warranting of industrial property, the granting of relative rights, or the granting of relative rights, or the granting of any license.
3. The products described in this document are intended to be used for standard applications or general electronic equipment (such as office equipment, communications equipment, measuring instruments and household appliances).
Consult our sales staff in advance for information on the formation on the Following applications :
 - Special applications (such as for airplanes, aerospace, automobiles, traffic control equipment, combustion equipment, life support systems and safety devices) in which exceptional quality and reliability are required, or if the failure or malfunction of the products may directly jeopardize life or harm the human body.
 - Any applications other than the standard applications intended.
4. When designing your equipment, comply with the guaranteed values, in particular those of maximum rating, the range of operating power supply voltage and heat radiation characteristics. Otherwise, we will not to be liable for any defect which may arise later in the equipment.
Even when the products are used within the guaranteed values, redundant design is recommended, so that such equipment may not violate relevant laws or regulations because of the function of our products.
5. When using products for which vacuum packing is required, observe the conditions (including shelf life and after-unpacking stand-by time) agreed upon when specification sheets are individually exchanged.

Sep. 1. 2000			