

User Manual

PCE-7129/5129/5029

LGA1151

Intel[®] Core[™] 7/i5/i3/Pentium[®] /
Xeon[®] PICMG 1.3 Single Host
Board with VGA/DVI-D/M.2/
(ECC)DDR4 U-DIMM/SATA3.0/
USB3.0/GbE

ADVANTECH

Enabling an Intelligent Planet

Copyright

The documentation and the software included with this product are copyrighted 2016 by Advantech Co., Ltd. All rights are reserved. Advantech Co., Ltd. reserves the right to make improvements in the products described in this manual at any time without notice. No part of this manual may be reproduced, copied, translated or transmitted in any form or by any means without the prior written permission of Advantech Co., Ltd. Information provided in this manual is intended to be accurate and reliable. However, Advantech Co., Ltd. assumes no responsibility for its use, nor for any infringements of the rights of third parties, which may result from its use.

Acknowledgements

AMIBIOS is a trademark of American Megatrends Inc.

Intel[®], Core™i7/i5/i3, Pentium[®] and Xeon are trademarks of Intel[®] Corporation.

Nuvoton is a trademark of Nuvoton Technology Corp.

All other product names or trademarks are the properties of their respective owners.

Product Warranty (2 years)

Advantech warrants to you, the original purchaser, that each of its products will be free from defects in materials and workmanship for two years from the date of purchase.

This warranty does not apply to any products which have been repaired or altered by persons other than repair personnel authorized by Advantech, or which have been subject to misuse, abuse, accident or improper installation. Advantech assumes no liability under the terms of this warranty as a consequence of such events.

Because of Advantech's high quality-control standards and rigorous testing, most of our customers never need to use our repair service. If an Advantech product is defective, it will be repaired or replaced at no charge during the warranty period. For out-of-warranty repairs, you will be billed according to the cost of replacement materials, service time and freight. Please consult your dealer for more details.

If you think you have a defective product, follow these steps:

1. Collect all the information about the problem encountered. (For example, CPU speed, Advantech products used, other hardware and software used, etc.) Note anything abnormal and list any onscreen messages you get when the problem occurs.
2. Call your dealer and describe the problem. Please have your manual, product, and any helpful information readily available.
3. If your product is diagnosed as defective, obtain an RMA (return merchandise authorization) number from your dealer. This allows us to process your return more quickly.
4. Carefully pack the defective product, a fully-completed Repair and Replacement Order Card and a photocopy proof of purchase date (such as your sales receipt) in a shippable container. A product returned without proof of the purchase date is not eligible for warranty service.
5. Write the RMA number visibly on the outside of the package and ship it prepaid to your dealer.

Declaration of Conformity

FCC Class A

NOTE: This equipment has been tested and found to comply with the limits for a Class A digital device, pursuant to part 15 of the FCC Rules. These limits are designed to provide reasonable protection against harmful interference when the equipment is operated in a commercial environment. This equipment generates, uses, and can radiate radio frequency energy and, if not installed and used in accordance with the instruction manual, may cause harmful interference to radio communications. Operation of this equipment in a residential area is likely to cause harmful interference in which case the user will be required to correct the interference at his own expense.

Caution! *There is a danger of a new battery exploding if it is incorrectly installed. Do not attempt to recharge, force open, or heat the battery. Replace the battery only with the same or equivalent type recommended by the manufacturer. Discard used batteries according to the manufacturer's instructions.*



A Message to the Customer

Advantech Customer Services

Each and every Advantech product is built to the most exacting specifications to ensure reliable performance in the harsh and demanding conditions typical of industrial environments. Whether your new Advantech equipment is destined for the laboratory or the factory floor, you can be assured that your product will provide the reliability and ease of operation for which the name Advantech has come to be known.

Your satisfaction is our primary concern. Here is a guide to Advantech's customer services. To ensure you get the full benefit of our services, please follow the instructions below carefully.

Technical Support

We want you to get the maximum performance from your products. So if you run into technical difficulties, we are here to help. For the most frequently asked questions, you can easily find answers in your product documentation. These answers are normally a lot more detailed than the ones we can give over the phone.

So please consult this manual first. If you still cannot find the answer, gather all the information or questions that apply to your problem, and with the product close at hand, call your dealer. Our dealers are well trained and ready to give you the support you need to get the most from your Advantech products. In fact, most problems reported are minor and are able to be easily solved over the phone.

In addition, free technical support is available from Advantech engineers every business day. We are always ready to give advice on application requirements or specific information on the installation and operation of any of our products.

Memory Compatibility

Model	Advantech PN	Capacity	Data Rate	Type	ECC	MPN
PCE-7129	AQD-D4U16E21-SE	16GB	2133	DDR4	Y	AQD-D4U16E21-SE
	AQD-D4U8GE21-SG	8GB	2133	DDR4	Y	AQD-D4U8GE21-SG
	AQD-D4U4GE21-SG	4GB	2133	DDR4	Y	AQD-D4U4GE21-SG
PCE-7129/5129/5029	AQD-D4U16N21-SE	16GB	2133	DDR4	N	AQD-D4U16N21-SE
	AQD-D4U8GN21-SG	8GB	2133	DDR4	N	AQD-D4U8GN21-SG
	AQD-D4U4GN21-SG	4GB	2133	DDR4	N	AQD-D4U4GN21-SG
	NA	4GB	2133	DDR4	N	TS512MLH64V1H

Processor Support

Model	Advantech P/N	CPU Processor Socket LGA1151	Base Freq. (GHz)	L3 cache	Cores/ Treads	TDP (W)	DDR4 memory speed support	ECC	AMT
PCE-7129	96MPXES-3.6-8M11T	E3-1275 v5	3.6	8	4/8	80	1600/2133	Yes	11.0
	96MPXES-3.3-8M11T	E3-1225 v5	3.3	6	4/4	80	1600/2133	Yes	11.0
	-	E3-1268L v5	2.4	8	4/8	35	1600/2133	Yes	11.0
PCE-7129/5129/5029	96MPI7S-3.4-8M11T	Core i7-6770	3.4	8	4/8	65	1600/2133	No	11.0
	96MPI7S-2.4-8M11T1	Core i7-6770TE	2.4	8	4/8	35	1600/2133	No	11.0
	96MPI5S-3.2-6M11T	Core i5-6500	3.2	6	4/4	65	1600/2133	No	11.0
	96MPI5S-2.3-6M11T1	Core i5-6500TE	2.3	6	4/4	35	1600/2133	Yes	11.0
	-	Core i3-6100	3.7	4	2/2	65	1600	Yes	-
	-	Core i3-6100TE	2.7	4	2/2	35	1600/2133	Yes	-
PCE-7129/5129/5029	96MPPS-3.3-3M11T	G4400	3.3	3	2/2	65	1600/2133	Yes	-
	-	G4400TE	2.9	3	2/2	35	1600/2133	Yes	-
	-	G3900	2.8	2	2/2	65	1600/2133	No	-
	-	G3900TE	2.6	2	2/2	35	1600/2133	No	-

Backplane Support Matrix Table

Model \ Backplane	PCE-5XXX	PCE-7XXX
PCE-5129/5029	Yes	-
PCE-7129	Yes	Yes (Except PCE-7B10-04A1E)

Note!  If SBC is used on different backplanes which has different PCIe configuration. Below message would be showed on first time power on, and user has to turn off AC power and then turn on for PCIe re-configuration.

Caution!  PCIe configuration error! Please turn off AC power before re-configuration.

Initial Inspection

Before you begin installing your motherboard, please make sure that the following materials have been shipped:

- 1 PCE-7129/5129/5029 PICMG 1.3 Single Host Board
- 1 PCE-7129/5129/5029 startup manual
- 1 CD with utility
- 2 Serial ATA HDD data cable P/N: 1700003194
- 1 Serial ATA HDD power cable P/N: 1700022749-11
- 1 COM + printer ports cable kit P/N: 1700022749-11
- 1 2-port USB cable kit P/N: 1700002204
- Keyboard and mouse Y cable P/N: 1700060202
- 1 jumper package P/N: 9689000068
- 1 warranty card

If any of these items are missing or damaged, contact your distributor or sales representative immediately. We have carefully inspected the PCE-7129/5129/5029 mechanically and electrically before shipment. It should be free of marks and scratches and in perfect working order upon receipt. As you unpack the PCE-7129/5129/5029, check it for signs of shipping damage. (For example, damaged box, scratches, dents, etc.) If it is damaged or it fails to meet the specifications, notify our service department or your local sales representative immediately. Also notify the carrier. Retain the shipping carton and packing material for inspection by the carrier. After inspection, we will make arrangements to repair or replace the unit.

Contents

Chapter 1	Hardware Configuration	1
1.1	Introduction	2
1.2	Features & Benefits	2
1.3	Specifications	3
1.3.1	System	3
1.3.2	Memory	3
1.3.3	Input/Output	3
1.3.4	Graphics	3
1.3.5	Ethernet LAN	4
1.3.6	Industrial features	4
1.3.7	Mechanical and environmental specifications	4
1.4	Jumpers and Connectors	5
	Table 1.1: Jumpers	5
	Table 1.2: Connectors	5
1.5	Board Layout: Jumper and Connector Locations	6
	Figure 1.1 Jumper and connector locations	6
1.6	Block Diagram	7
	Figure 1.2 PCE-7129 block diagram	7
	Figure 1.3 PCE-5129 block diagram	7
	Figure 1.4 PCE-5029 block diagram	8
1.7	Safety Precautions	8
1.8	Jumper Settings	9
1.8.1	How to set jumpers	9
1.8.2	BIOS CMOS (JCMOS1)	9
	Table 1.3: JCMOS1/JME1: clear CMOS/ME data	9
1.8.3	Watchdog timer output (JWDT1)	9
	Table 1.4: Watchdog timer output (JWDT1)	9
	Table 1.5: H/W monitor alarm (JOBS1)	10
1.9	System Memory	10
1.10	Memory Installation Procedures	10
1.11	Cache Memory	10
1.12	Processor Installation	11
1.13	Processor Cooler Installation	13
Chapter 2	Connecting Peripherals	15
2.1	Introduction	16
2.2	Parallel Port (LPT1)	16
2.3	USB Ports (USB12, USB3, USB4, USB56, USB78)	16
2.4	VGA Connectors (VGA1)	17
2.5	Serial Ports (COM1 & COM2)	17
2.6	PS/2 Keyboard and Mouse Connector (KBMS1/KBMS2)	18
2.7	CPU and System Fan Connectors (CPUFAN1 and SYSFAN1)	18
2.8	Front Panel Connectors (JFP1, JFP2 & JFP3)	19
2.8.1	Power LED and keyboard lock (JFP3)	19
	Table 2.1: PS/2 or ATX power supply LED status	19
2.8.2	External speaker (JFP2)	19
2.8.3	Reset connector (JFP1)	19
2.8.4	HDD LED connector (JFP2)	20
2.8.5	ATX soft power switch (JFP1)	20
2.9	H/W Monitor/Watchdog Timer/Infrared	21
2.9.1	H/W monitor alarm (JOBS1)	21
2.9.2	Watchdog timer (JWDT1)	21
2.9.3	Infrared interface (JIR1)	21

2.10	LAN Ports (LAN1 & LAN2) and Front Panel LAN Indicator Connector (LANLED1).....	22
	Table 2.2: LAN LED Indicators	22
2.11	High Definition Audio Module Interface (HDAUD1)	23
2.12	GPIO Header (GPIO1).....	23
2.13	Case Open Connector (JCASE1 and JCASEOP_SW1).....	24
	Figure 2.1 Case Open Jumper Locations	24
	Table 2.3: Case open mode Jumper	24
	Figure 2.2 Case Open Warning in BIOS Menu	25
2.14	Serial ATA Interface (SATA1~SATA5).....	25
2.15	LPC Extension Interface (LPC1).....	26

Chapter 3 AMI BIOS Setup..... 27

3.1	Introduction	28
	Figure 3.1 Setup program initial screen.....	28
3.2	Entering Setup	29
3.2.1	Main Setup.....	29
	Figure 3.2 Main setup screen	29
3.2.2	Advanced BIOS Features Setup.....	30
	Figure 3.3 Advanced BIOS features setup screen	30
	Figure 3.4 Trust Computing.....	31
	Figure 3.5 ACPI Settings	32
	Figure 3.6 AMT Configuration	33
	Figure 3.7 Firmware Update Configuration	34
	Figure 3.8 Smart Setting.....	35
	Figure 3.9 Super IO Configuration.....	36
	Figure 3.10Serial Port 1 or 2 Configuration	36
	Figure 3.11Parallel Configuration	37
	Figure 3.12PC Health Status.....	38
	Figure 3.13S5 RTC configuration	39
	Figure 3.14Serial Port console redirection	40
	Figure 3.15CPU Configuration	41
	Figure 3.16Platform Misc Configuration	42
	Figure 3.17SATA Configuration.....	43
	Figure 3.18PCI Subsystem Settings.....	44
	Figure 3.19PCI Express Settings	45
	Figure 3.20USB Configuration.....	46
3.2.3	Chipset.....	47
	Figure 3.21Chipset	47
	Figure 3.22System Agent (SA) Configuration	47
	Figure 3.23Graphics Configuration.....	49
	Figure 3.24PEG Port Configuration.....	50
	Figure 3.25Memory Information	51
	Figure 3.26PCH IO Configuration.....	51
	Figure 3.27PCI Express Configuration	52
	Figure 3.28USB Configuration.....	53
	Figure 3.29PCH Azalia Configuration.....	54
3.2.4	Security.....	55
	Figure 3.30Security	55
3.2.5	Boot	56
	Figure 3.31 Boot.....	56
3.2.6	Save & Exit	57
	Figure 3.32Save & Exit.....	57

Chapter 4 Value-Added Software Services 59

4.1	Value-Added Software Services	60
4.1.1	Software API.....	60

	4.1.2	Software Utility	61
Chapter	5	Chipset Software Installation Utility	63
	5.1	Before You Begin	64
	5.2	Introduction	64
	5.3	Windows 7/8.1/10 8 Driver Setup.....	65
Chapter	6	Integrated Graphic Device Setup	67
	6.1	Introduction	68
	6.2	Windows 7/8.1/10 Driver Setup.....	68
Chapter	7	LAN Configuration.....	69
	7.1	Introduction	70
	7.2	Installation	70
	7.3	Windows 7/8.1/10 Driver Setup (LAN)	70
Chapter	8	Intel ME	71
	8.1	Introduction	72
	8.2	Installation	72
Chapter	9	Intel USB 3.0	73
	9.1	Introduction	74
	9.2	Installation	74
Chapter	10	SATA RAID Setup	75
	10.1	Introduction	76
	10.2	SATA RAID Driver and Utility Setup	76
Appendix A		Programming the Watchdog Timer..	77
	A.1	Introduction	78
	A.1.1	Watchdog timer overview.....	78
	A.1.2	Programming the watchdog timer	78
		Table A.1: Watchdog timer registers.....	79
	A.1.3	Example program.....	80
Appendix B		I/O Pin Assignments.....	85
	B.1	Parallel Port Connector (LPT1).....	86
		Table B.1: Parallel port connector (LPT1).....	86
	B.2	VGA Connector (VGA1).....	86
		Table B.2: VGA connector (VGA1)	86
	B.3	RS 232 Serial Port (COM12).....	87
		Table B.3: RS-232 serial port (COM2).....	87
	B.4	USB 2.0 Header (USB56 & 910).....	87
		Table B.4: USB Header (USB56 & 910)	87
	B.5	USB3.0 Header (USB12)	88

	Table B.5: USB 3.0 Header (USB12)	88
B.6	PS/2 Keyboard/Mouse Connector (KBMS1).....	88
	Table B.6: PS/2 keyboard/mouse connector (KBMS1).....	88
B.7	External Keyboard Connector (KBMS2)	89
	Table B.7: External keyboard connector (KBMS2)	89
B.8	CPU and System Fan Power Connector (CPUFAN1 /SYSFAN1).....	89
	Table B.8: CPU and system fan power connector (CPUFAN1).....	89
B.9	Power LED and Keyboard Lock Connector (JFP3 / PWR_LED & KEY LOCK).....	89
	Table B.9: Power LED and keyboard lock connector (JFP3 / PWR_LED & KEY LOCK)	89
B.10	External Speaker Connector (JFP2 / SPEAKER).....	90
	Table B.10:External speaker connector (JFP2 / SPEAKER).....	90
B.11	Reset Connector (JFP1 / RESET)	90
	Table B.11:Reset connector (JFP1 / RESET)	90
B.12	HDD LED (JFP2 / HDDLED).....	90
	Table B.12:HDD LED (JFP2 / HDDLED)	90
B.13	ATX Soft Power Switch (JFP1 / PWR_SW).....	91
	Table B.13:ATX soft power switch (JFP1 / PWR_SW).....	91
B.14	Hi-definition Audio Link Connector (HDAUD1)	91
	Table B.14:Hi-definition audio link connector (HDAUD1)	91
B.15	SM Bus Connector (JFP2 / SNMP).....	91
	Table B.15:SM bus connector (JFP2 / SNMP)	91
B.16	LAN1 and LAN2 LED Connector (LANLED1).....	92
	Table B.16:LAN1 and LAN2 LED connector (LANLED1)	92
B.17	GPIO Header (GPIO1).....	92
	Table B.17:GPIO header (GPIO1).....	92
B.18	Fixed I/O Ranges Decoded by Intel PCH	93
	Table B.18:Fixed I/O Ranges Decoded by PCH.....	93
B.19	System I/O Ports.....	94
	Table B.19:System I/O Ports	94
B.20	Interrupt Assignments	94
	Table B.20:Interrupt Assignments	94
B.21	1 MB Memory Map.....	95
	Table B.21:1 MB memory map	95
B.22	PCI Bus Map.....	95
	Table B.22:PCI Bus Map	95

Appendix C Programming the GPIO 97

C.1	Supported GPIO Register	98
C.2	GPIO Registers.....	98
C.3	GPIO Example Program-1	98

Chapter 1

Hardware
Configuration

1.1 Introduction

PCE-7129/5129/5029 is a PICMG 1.3 form-factor single host board which is designed with Intel® C236 (PCE-7129), Q170 (PCE-5129), and H110 (PCE-5029) PCH for industrial applications that need high computing power and strong I/O capability. PCE-7129/5129/5029 supports 14nm manufacturing technology, LGA1151 socket Intel® Core™ i7/i5/i3, Pentium® and Xeon™ processors that integrate memory and graphic controllers, and support for DDR4 2133 SDRAM up to 32 GB. Within advanced computing technology, PCE-7129/5129/5029 is suitable for processor hungry industrial applications.

PCE-7129/5129/5029 offers excellent graphics capability with its integrated Intel® HD graphics core with a minimum 1 GB shared memory (requires a minimum 2GB system memory). With this, PCE-7129/5129/5029 provides strong 2D/3D graphics processing power without an additional graphic card to save extra cost, power consumption and thermal integration effort.

PCE-7129/5129/5029 features rich I/O interface: M.2 which can support M.2 (2280) type-M for both SATA3.0 (6 Gb/s) and PCIe4 (Gen3.0; 32 Gb/s) devices, SATA 3.0 ports with SW raid 0, 1, 5, 10, integrated USB 3.0 controllers @ 5Gbps, 2 x RS-232 serial COM ports. Moreover, PCE-7129/5129/5029 can support Advantech PCE-5BXX and PCE-7BXX (PCE-7129 only) series backplanes offering various combinations of expansion such as PCI, PCI-X and PCIe slots. With flexible I/O and graphic expansibility, PCE-7129/5129/5029 is an excellent, cost effective graphic or I/O oriented workstation class hardware platform. With outstanding performance and exceptional features, PCE-7129/5129/5029 is the ideal computing platform for advanced industrial applications.

1.2 Features & Benefits

- **Processor support:** Intel 6th generation family processors with the latest 14nm lithography.
- **Memory Capacity:** Supports (ECC;C236) DDR4 2133 U-DIMM 16GB per DIMM up to 32 GB memory capacity. DDR4 provides up to 50% increased performance and bandwidth while saving up to 40% power.
- **Memory technology:** Supports up to 1024M x 8 memory die.
- **Storage:** Support M.2 (2280) type-M SSD module for both SATA3.0 and PCIe4 interfaces, and SATA 3.0 ports with SW raid 0, 1, 5, 10 support.
- **High Performance I/O capability:** Provides high transfer data performance interface; USB 3.0 data transfer rate is 5 Gbps which is 10 times faster than USB2.0.
- **PCIe architecture:** Processor supports 16 link PCI Express generation 3.0 and PCH support 4 links of PCI Express generation 3.0 to PICMG1.3 backplanes.
- **SUSI API:** Support SUSIAccess and Intelligent system module for remote management.

1.3 Specifications

1.3.1 System

- **CPU:** LGA1151-socket Core i7/i5/i3, Pentium and Xeon E3-1200 v5 series processors
- **L2 Cache:** Please refer to CPU specification for detailed information.
- **BIOS:** AMI SPI BIOS (128 Mb SPI).
- **System Chipset:** Intel C236 (PCE-7129); Intel Q170 (PCE-5129); Intel H110 (PCE-5029)
- **SATA hard disk drive interface:** Five (PCE-7129/5129) or four (PCE-5029) SATA3 (600MB/s) ports are with blue connector. These interfaces can be enabled/disabled in the BIOS.
- **M.2(2280) Type-M:** Supports SATA3.0 and PCIe3.0 with x4 links device.

Note! PCE-7129/5129/5029 does NOT support PATA (IDE) interface.



Only PCE-7129 supports Intel Xeon processors.

1.3.2 Memory

- **RAM:**
 - PCE-7129: Up to 32 GB in two 288-pin DIMM sockets. Supports dual-channel DDR4 1866/2133 SDRAM WITH or WITHOUT ECC function.
 - PCE-5129/5029: Up to 32 GB in two 288-pin DIMM sockets. Supports dual-channel DDR4 1866/2133 SDRAM WITHOUT ECC function.

Note! A 32-bit OS may not fully detect 4 GB of RAM when 4 GB is installed.



Please select Intel ECC supported processor to enable ECC function.

1.3.3 Input/Output

- **PCIe bus:** One PCIe x16 or Two PCIe x8 from CPU and One PCIe x4 from PCH
- **PCI bus:** Four PCI masters to the backplane, 32-bit, 33 MHz PCI 2.2 compliant.
- **Enhanced parallel port:** This EPP/SPP/ECP port can be configured to LPT1, LPT2, LPT3 or disabled. A standard DB-25 female connector provided.
- **Serial ports:** Two RS-232 serial ports
- **PS/2 keyboard and mouse connector:** One 6-pin mini-DIN connectors is located on the mounting bracket for easy connection to a PS/2 keyboard and mouse via the Y-cable included in the package.
- **USB port:** Supports 7 x USB 2.0 ports with transfer rates up to 480 Mbps. (5 ports are on the CPU card and 4 ports are on the backplane), and 5 USB 3.0 ports with transfer rates of up to 5 Gbps.
- **LPC:** One LPC connector supports Advantech TPM LPC modules.
- **GPIO:** Supports 8-bit GPIO from super I/O for general purpose control application.

1.3.4 Graphics

- **Controller:** Intel® HD Graphics embedded in the processor.
- **Display memory:** Shared memory is subject to OS (install 2 GB or above memory for basic system configuration).

- **CRT:** Up to 1920 x 1200 resolution, 60 MHz RAMDAC.
- **DVI-D:** Two DVI-D pin header ports support resolutions up to 1920 x 1200 @ 60 Hz.
- **Display Port:** Supports resolution up to 4096 x 2304 @ 60 Hz, 24bpp (Supporting 4K display required two DDR channels of same size).
- **PCI express x16/x8 slot on the backplane:** An external graphic card can be installed in the PCIe x16 / x8 slot for high 2D/3D graphics capability.

1.3.5 Ethernet LAN

- Supports single/dual 10/100/1000 Mbps Ethernet port(s) via the dedicated PCI Express x1 bus which provides 500 MB/s data transmission rate.
- **Controller:**
 - LAN 1: Intel® I219LM (PCE-7129/5129); I219V (PCE-5029)
 - LAN 2: Intel® i211AT (PCE-5129/5029); I210AT(PCE-7129)

1.3.6 Industrial features

- **Watchdog timer:** Can generate a system reset. The watchdog timer is programmable, with each unit equal to one second or one minute (255 levels).

1.3.7 Mechanical and environmental specifications

- **Operating temperature:** 0 ~ 60 °C (32 ~ 140 °F, depending on CPU and thermal solution)
- **Storage temperature:** -40 ~ 85 °C (-40 ~ 185 °F)
- **Humidity:** 20 ~ 95% non-condensing
- **Power supply voltage:** +3.3 V, +5 V, +12 V, +5 V_{SB}
- **Power consumption:** Processor: Intel Core i7-6700; Memory: DDR4 2133 8 GB x 2

Voltage	+12 V	+5 V	+3.3 V	+5 VSB	-12 V	-5 V
Current	2.64 A	1.23 A	0.19 A	0.09 A	0.06 A	0 A

- **Board size:** 338.58 mm (L) x 126.39 mm (W) (13.3" x 4.98")
- **Board weight:** 0.5 kg

1.4 Jumpers and Connectors

Connectors on the PCE-7129/5129/5029 single host board link it to external devices such as hard disk drives and a keyboard. In addition, the board has a number of jumpers used to configure your system for your application.

The tables below list the function of each of the board jumpers and connectors. Later sections in this chapter give instructions on setting jumpers. Chapter 2 gives instructions for connecting external devices to your motherboard.

Table 1.1: Jumpers

Label	Function
JCMOS1	CMOS clear
JME1	Clear ME data
JWDT1	Watchdog timer output selection
JOBS1	Super IO Alarm setting

Table 1.2: Connectors

Label	Function
USB3_1	USB3 port1
LAN1	Intel I219LM (PCE-7129/5129); Intel I219V (PCE-5029)
LAN2	Intel I210AT (PCE-7129); Intel I211 (PCE-5129/5029)
VGA1	VGA connector
KBMS1	External PS/2 keyboard and mouse connector
KBMS2	Internal PS/2 keyboard and mouse connector
HDAUD1	Advantech HD audio module expansion pin-header
LPC1	LPC module expansion pin-header
Sysfan1	4 PIN fan power connector for supporting PWM or DC fan
LANLED1	LANLED
USB11	USB port 10
USB45	USB port 4, 5
USB3_45	USB3 port 4, 5
USB3_23	USB3 port 2,3
COM1	RS-232 (9-pin Box Header)
COM2	RS-232 (9-pin Box Header)
LPT1	Parallel port
SATA0 / NGFF1	SATA port 0 or PCIe4
SATA 1~5	SATA Port 1 ~ 5
SPI_CN1	CMOS flash jig pin-header
SPI1	CMOS ROM
DP1	Display port pin-header 1
DP2	Display port pin-header 1
JCMOS1	Clear CMOS
JME1	Clear ME
JFP1 + JFP2	Power Switch / Reset connector / External speaker / SATA HDD LED connector

JFP3 (Keyboard Lock and Power LED)	Power LED Suspend: Fast flash (ATX/AT) System On: ON (ATX/AT) System Off: OFF (ATX/AT)
CPUFAN1	CPU FAN Power connector
JCASE1	Case Open pin-header
JCASEOP_SW1	Case Open switch for always open or close
BAT1	Button battery socket
BAT2	External battery connector
GPIO1	GPIO pin header (SMD pitch-2.0 mm)
DIMMA1	Memory connector channel A
DIMMB1	Memory connector channel B

1.5 Board Layout: Jumper and Connector Locations

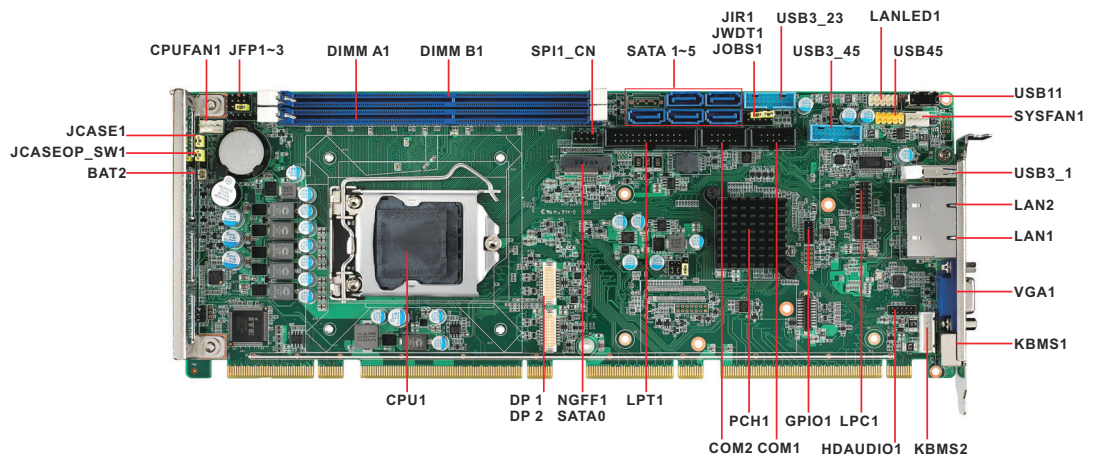

Figure 1.1 Jumper and connector locations

1.6 Block Diagram

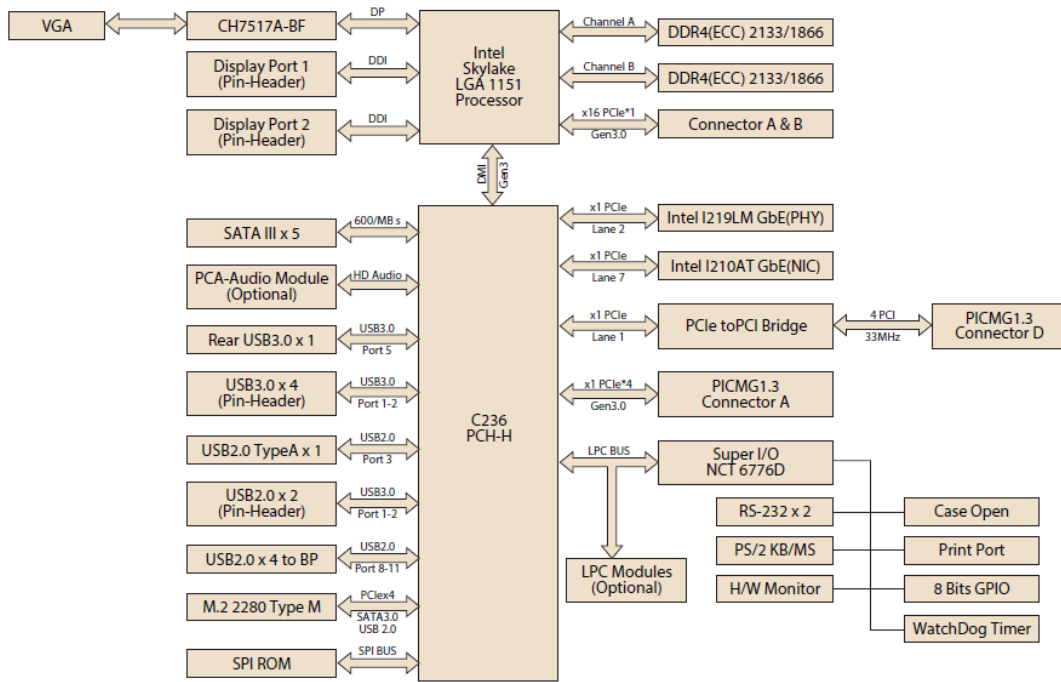

Figure 1.2 PCE-7129 block diagram

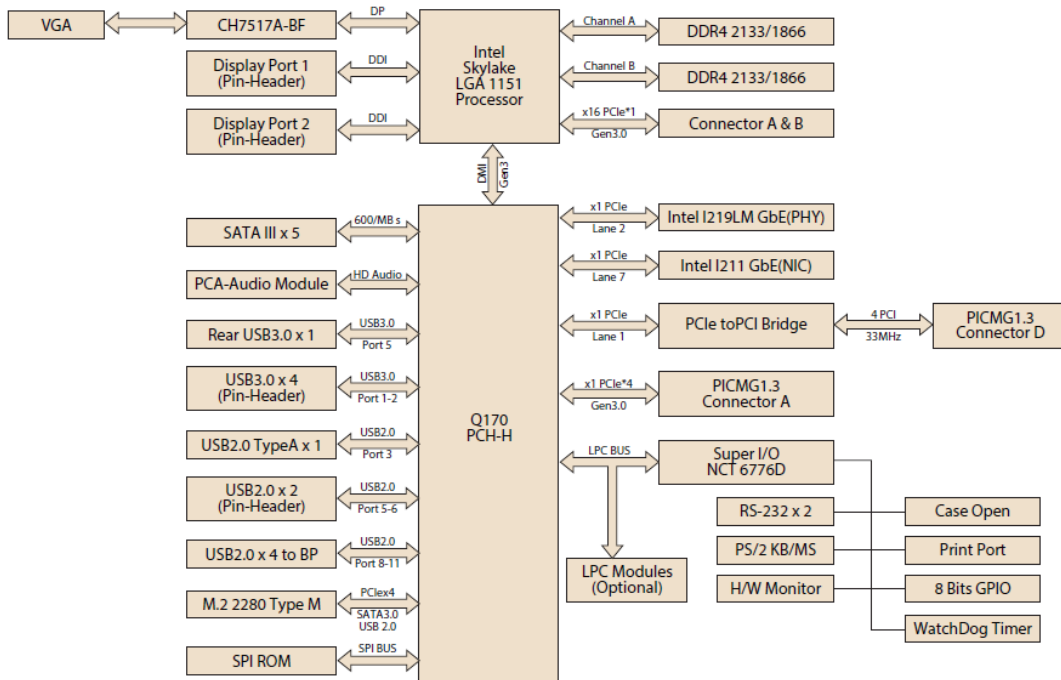

Figure 1.3 PCE-5129 block diagram

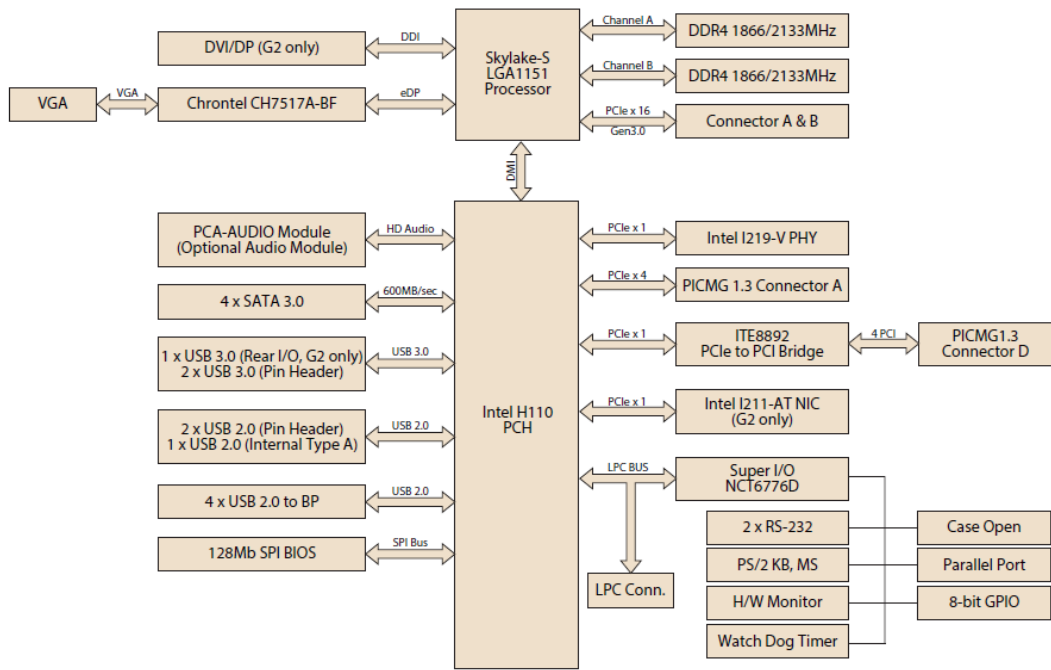

Figure 1.4 PCE-5029 block diagram

1.7 Safety Precautions

Warning! Always completely disconnect the power cord from your chassis whenever you work with the hardware. Do not make connections while the power is on. Sensitive electronic components can be damaged by sudden power surges. Only experienced electronics personnel should open the PC chassis.



Caution! Always ground yourself to remove any static charge before touching the motherboard. Modern electronic devices are very sensitive to static electrical discharges. As a safety precaution, use a grounding wrist strap at all times. Place all electronic components on a static-dissipative surface or in a static-shielded bag when they are not in the chassis.



Caution! The computer is provided with a battery-powered Real-time Clock. There is a danger of explosion if battery is incorrectly replaced. Replace only with same or equivalent type recommended by the manufacturer. Discard used batteries according to manufacturer's instructions.



Caution! There is a danger of a new battery exploding if it is incorrectly installed. Do not attempt to recharge, force open or heat the battery. Replace the battery only with the same or equivalent type recommended by the manufacturer. Discard used batteries according to the manufacturer's instructions.



1.8 Jumper Settings

This section provides instructions on how to configure your motherboard by setting the jumpers. It also includes the motherboard's default settings and your options for each jumper.

1.8.1 How to set jumpers

You can configure your motherboard to match the needs of your application by setting the jumpers. A jumper is a metal bridge that closes an electrical circuit. It consists of two metal pins and a small metal clip (often protected by a plastic cover) that slides over the pins to connect them. To “close” (or turn ON) a jumper, you connect the pins with the clip. To “open” (or turn OFF) a jumper, you remove the clip. Sometimes a jumper consists of a set of three pins, labeled 1, 2 and 3. In this case you connect either pins 1 and 2, or 2 and 3. A pair of needle-nose pliers may be useful when setting jumpers.

1.8.2 BIOS CMOS (JCMOS1)

The SBC CPU card contains a jumper that can erase BIOS CMOS/ME data and reset the system BIOS information. Normally this jumper should be set with pins 1-2 closed. If you want to reset those data, set JCMOS1/JME1 to 2-3 closed for just a few seconds, and then move the jumper back to 1-2 closed. This procedure will reset the CMOS/ME to its last status or default setting.

Table 1.3: JCMOS1/JME1: clear CMOS/ME data

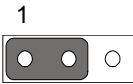
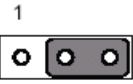
Function	Jumper Setting
*Keep BIOS CMOS/ME data	 1-2 closed
Clear BIOS CMOS/ME data	 2-3 closed

* default setting

1.8.3 Watchdog timer output (JWDT1)

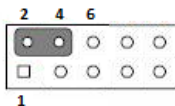
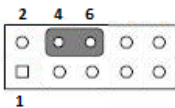

The SBC contains a watchdog timer that will reset the CPU in the event the CPU stops processing. This feature means the SBC will recover from a software failure or an EMI problem. The JWDT1 jumper settings control the outcome of what the computer will do in the event the watchdog timer is tripped.

Table 1.4: Watchdog timer output (JWDT1)

Function	Jumper Setting
NC	 2-4 closed
* Reset	 4-6 closed

* default setting

Table 1.5: H/W monitor alarm (JOBS1)

Function	Jumper Setting
Enabled	 1-2 closed (Default)
Disabled	 1-2 opened

(JOBS1) is a 2-pin connector for setting enable/disable alarm while the on-board security event acts.

1.9 System Memory

PCE-7129/5129/5029 has two 288-pin memory sockets for (ECC) DDR4 1866/2133 memory modules with maximum capacity of 32GB. (Maximum 16GB for each DIMM)

PCE-7129 supports ECC and non-ECC DDR4 U-DIMM memory modules.

PCE-5129/5029 supports non-ECC DDR4 U-DIMM memory modules.

Note! PCE-7129/5129/5029 do NOT support registered DIMMs (RDIMMs).



1.10 Memory Installation Procedures

To install DIMMs, first make sure the two handles of the DIMM socket are in the “open” position. i.e. the handles lean outward. Slowly slide the DIMM module along the plastic guides on both ends of the socket. Then press the DIMM module right down into the socket, until you hear a click. This is when the two handles have automatically locked the memory module into the correct position of the DIMM socket. To remove the memory module, just push both handles outward, and the memory module will be ejected by the mechanism in the socket.

Note! Because PCE-7129/5129 supports Intel Active Management Technology 11.0 (AMT11.0) which utilizes some memory space of channel 0, it's suggested that the user should not leave channel 0 DIMM slots (DIMMA1) empty, or it may cause some system abnormality.



1.11 Cache Memory

L3 memory cache size is subject to each Intel processor and please refer to the Intel datasheet for detailed information.

1.12 Processor Installation

Warning! Without a fan or heat sink, the processor will overheat and cause damage to both the processor and the single board computer. To install a processor, first turn off your system.



The PCE-7129/5129/5029 is designed for Intel® LGA 1151 socket processors.

1. Pull the bar beside the processor socket outward and lift it.

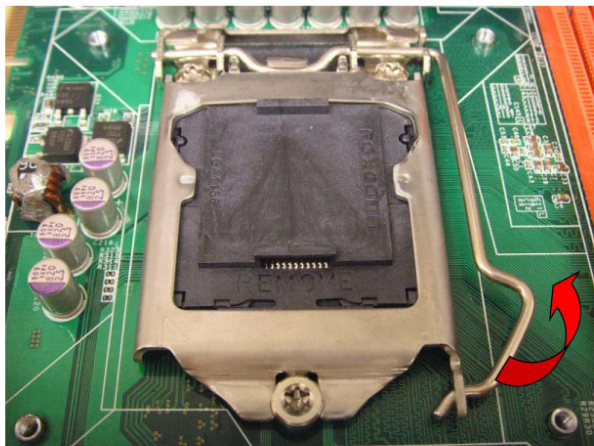

2. Remove the socket protection cap.

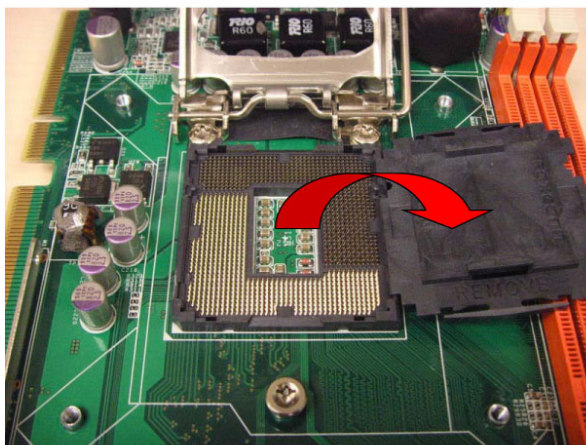

3. Align the cuts on the processor with the edges of the socket.

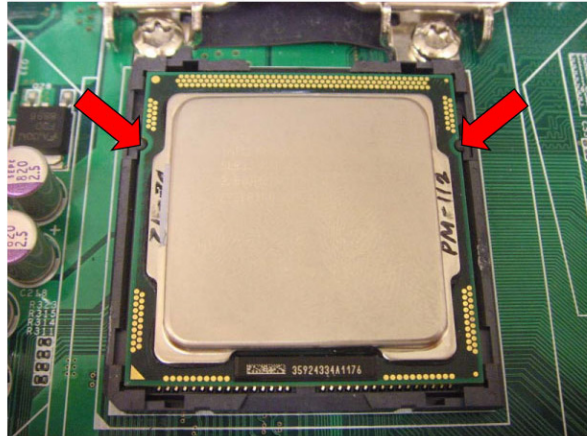

4. Replace the socket cap; lower the retainer bar and clip it shut.

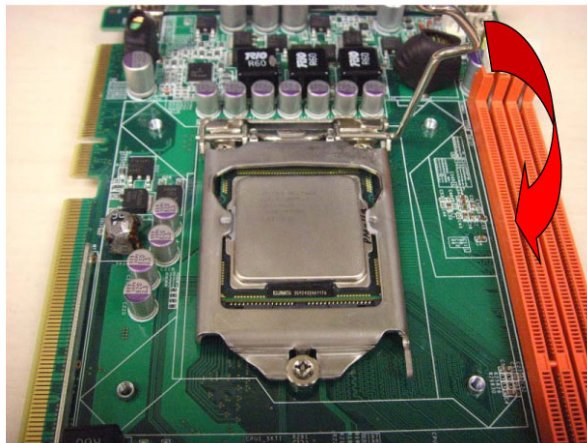

5. The finished processor installation.

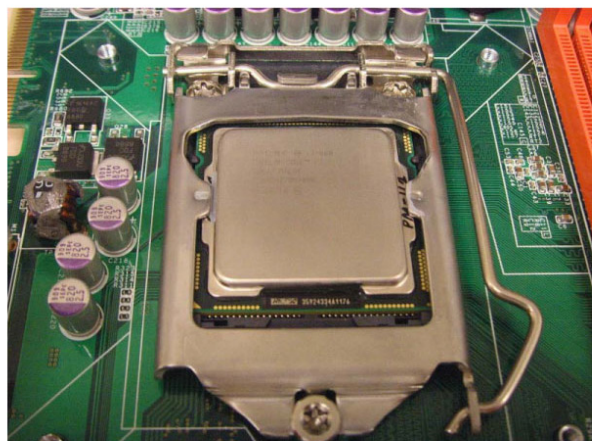

1.13 Processor Cooler Installation

Purchasing PCE-7129/5129/5029 optimized CPU cooler (P/N: 1960052651N021) from Advantech is a must. Other brand CPU coolers are NOT compatible with PCE-7129/5129/5029. Advantech specially designed CPU cooler and CPU plate is for better heat dissipation efficiency and for enhancing rigidity of the CPU card (neither is it compatible with Intel boxed CPU cooler). Please install 1960052651N021 CPU cooler following these instructions.

Attach the CPU cooler on CPU card by fastening four screws of the CPU cooler into the steel back-plate on PCB.

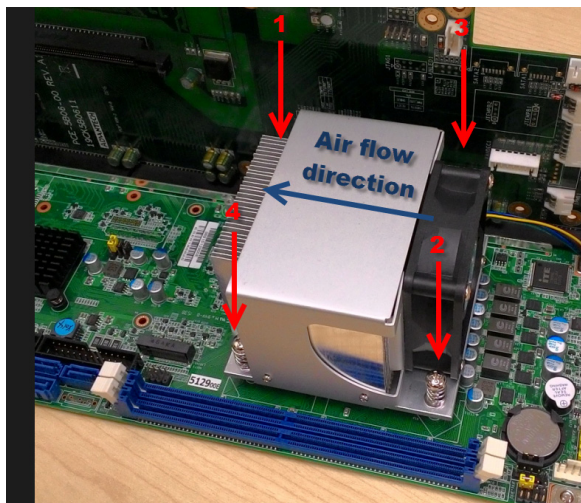

Note the direction of CPU cooler; it must follow that shown above. Installing a CPU cooler in the wrong direction may cause poor heat dissipation that may damage the CPU card.

Chapter 2

Connecting
Peripherals

2.1 Introduction

You can access most of the connectors from the top of the board. If you have a number of cards installed, you may need to partially remove the card to make all the connections.

2.2 Parallel Port (LPT1)

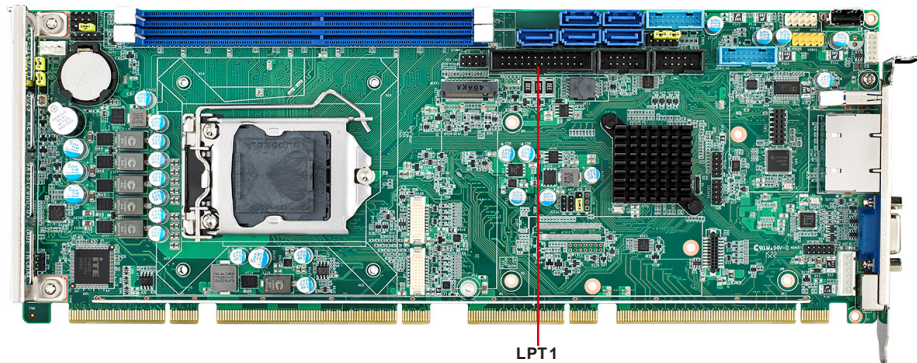

The parallel port is normally used to connect the motherboard to a printer. The SBC includes an onboard parallel port, accessed through a 26-pin flat-cable connector.

2.3 USB Ports (USB12, USB3, USB4, USB56, USB78)

Each SBC provides both USB2.0 and USB3.0 on-board ports with complete Plug & Play and hot swap support for up to 127 external devices. These USB ports comply with USB Specification 2.0 and 3.0, and support transfer rates up to 480 Mbps (USB2.0) and 5 Gbps (USB 3.0). The USB controller can be disabled in the system BIOS setup.

Note! *Disabling USB controller in the BIOS menu will turn off all USB ports function.*

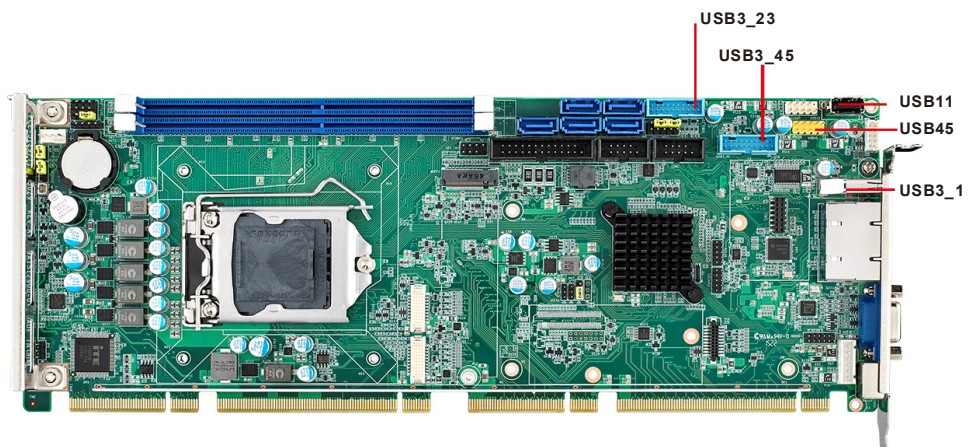

2.4 VGA Connectors (VGA1)

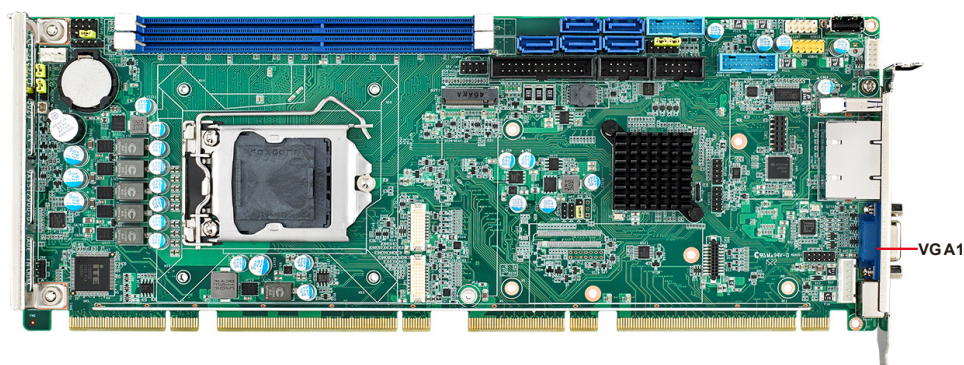

This CPU card has VGA outputs that can drive conventional CRT displays. VGA1 is a standard 15-pin D-SUB connector commonly used for VGA.

2.5 Serial Ports (COM1 & COM2)

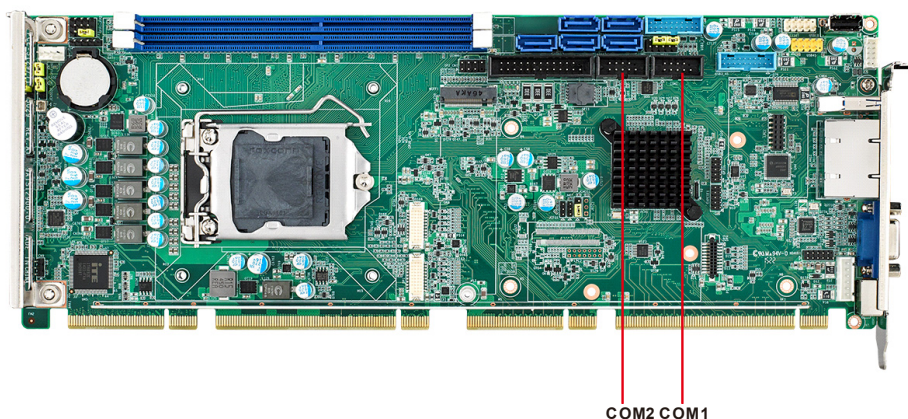

These SBCs offer two serial ports. These ports can connect to serial devices, such as a mouse or a printer, or to a communications network.

The IRQ and address ranges for both ports are fixed. However, if you want to disable the port or change these parameters later, you can do this in the system BIOS setup. Optional dual COM cable, 1701092300, is available as well.

Note! *PCE-5029VG sku features one rear COM and one internal pin-header COM port.*



2.6 PS/2 Keyboard and Mouse Connector (KBMS1/KBMS2)

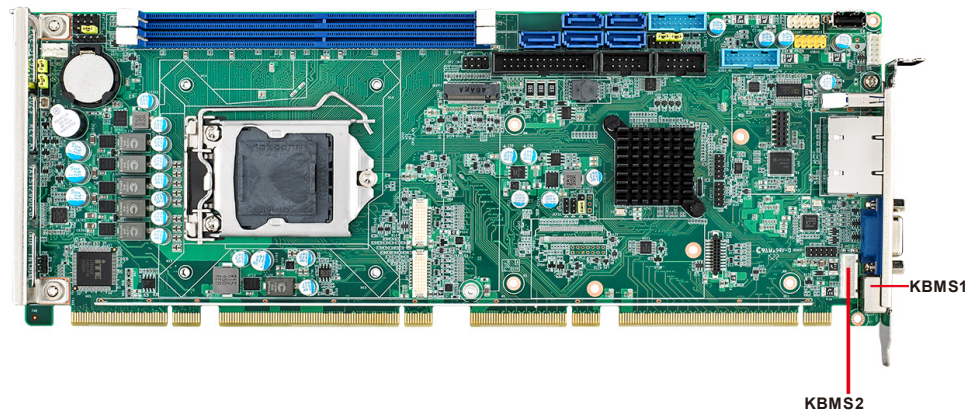

Two on-board 6-pin mini-DIN connectors (KBMS1) provide connection to a PS/2 keyboard and mouse by the Y-cable (1700060202) in the package.

The on-board KBMS2 pin header provides connection to the front panel PS/2 keyboard and mouse connector of the chassis.

2.7 CPU and System Fan Connectors (CPUFAN1 and SYSFAN1)

This fan connector supports 3-pin or 4-pin fan coolers and smart fan functions.

Note! CPU and system fan connectors can support both PWM and DC FAN.
System fan connector can support one system fan.

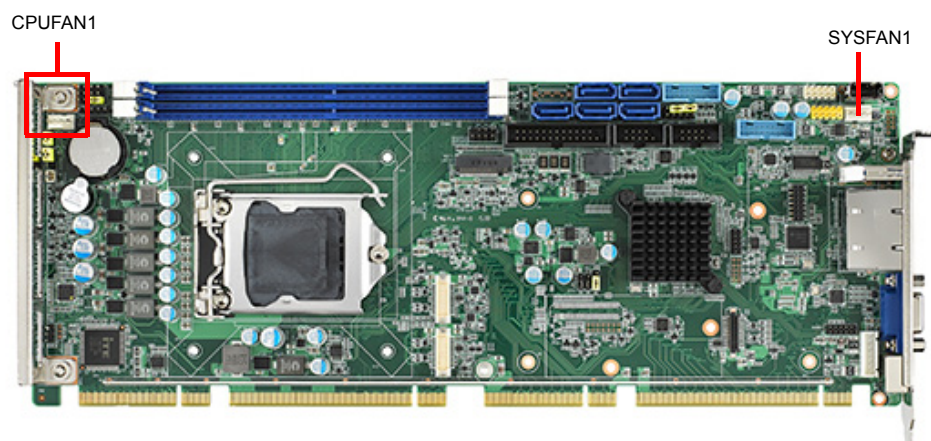

2.8 Front Panel Connectors (JFP1, JFP2 & JFP3)

There are several external switches to monitor and control the PCE-7129/5129/5029.

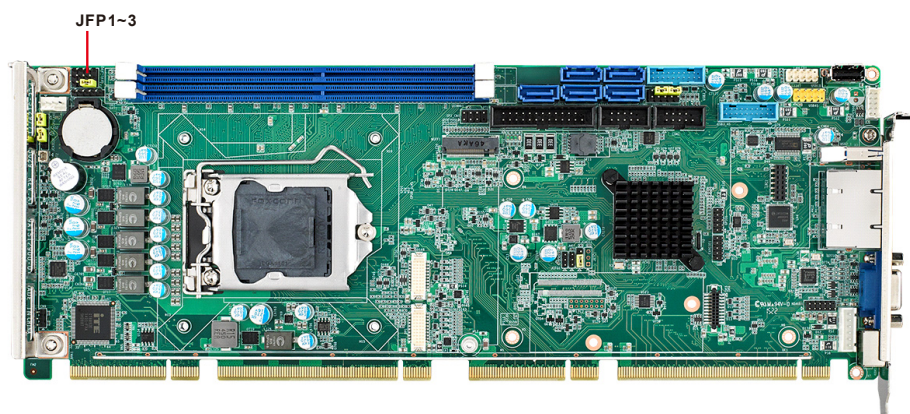

2.8.1 Power LED and keyboard lock (JFP3)

JFP3 is a 5-pin connector for the power LED. Refer to Appendix B for detailed information on the pin assignments. If a PS/2 or ATX power supply is used, the system's power LED status will be as indicated below:

Table 2.1: PS/2 or ATX power supply LED status

Power mode	LED (PS/2 power)	LED (ATX power)
System On	On	On
System Suspend	Flashes	Flashes
System Off	Off	Off

JFP1	PWR_SW	Reset
JFP2	HDD LED	SNMP
	Speaker	
JFP3	PWR_LED & Key Lock	

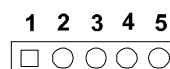

2.8.2 External speaker (JFP2)

JFP2 is a 4-pin connector for an external speaker. The PCE-7129/5129/5029 provides an onboard buzzer as an alternative to an external speaker. To enable the buzzer, set pins 3 and 4 as closed.

JFP1	PWR_SW	Reset
JFP2	HDD LED	SNMP
	Speaker	
JFP3	PWR_LED & Key Lock	

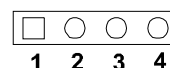

2.8.3 Reset connector (JFP1)

Many computer cases offer the convenience of a reset button. Connect the wire from the reset button.

JFP1	PWR_SW	Reset
JFP2	HDD LED	SNMP
	Speaker	
JFP3	PWR_LED & Key Lock	

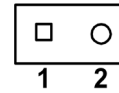

2.8.4 HDD LED connector (JFP2)

You can connect an LED to connector JFP2 to indicate when the HDD is active.

JFP1	PWR_SW	Reset
JFP2	HDD LED	SNMP
	Speaker	
JFP3	PWR_LED & Key Lock	

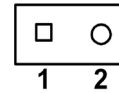

2.8.5 ATX soft power switch (JFP1)

If your computer case is equipped with an ATX power supply, you should connect the power on/off button on your computer case to JFP1. This connection enables you to turn your computer on and off.

JFP1	PWR_SW	Reset
JFP2	HDD LED	SNMP
	Speaker	
JFP3	PWR_LED & Key Lock	

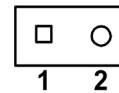

2.9 H/W Monitor/Watchdog Timer/Infrared

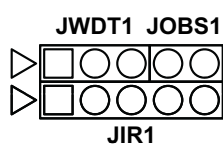
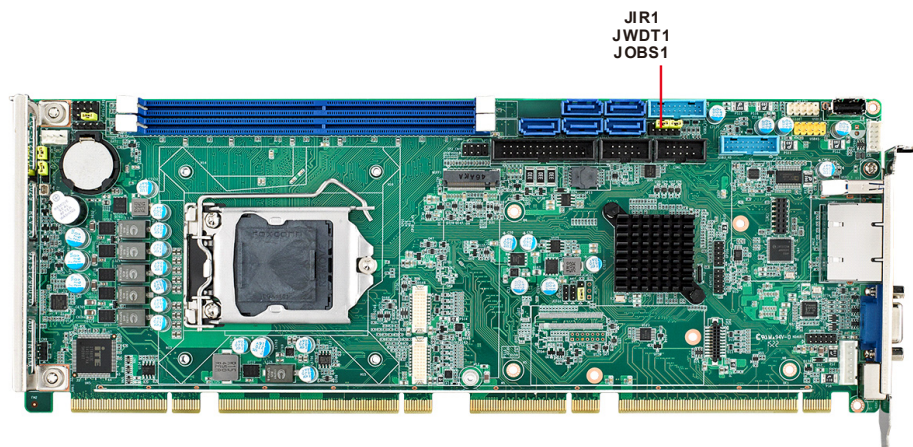

2.9.1 H/W monitor alarm (JOBS1)

This 2-pin header is for enabling/disabling H/W monitor alarm function.

Closed: Enables OBS Alarm

Open: Disables OBS Alarm

2.9.2 Watchdog timer (JWDT1)

This is for setting action trigger by watchdog timer.

1-2 Pin Close: No Action

2-3 Pin Close: System Reset

2.9.3 Infrared interface (JIR1)

This is a 5-pin header for an infrared device.

2.10 LAN Ports (LAN1 & LAN2) and Front Panel LAN Indicator Connector (LANLED1)

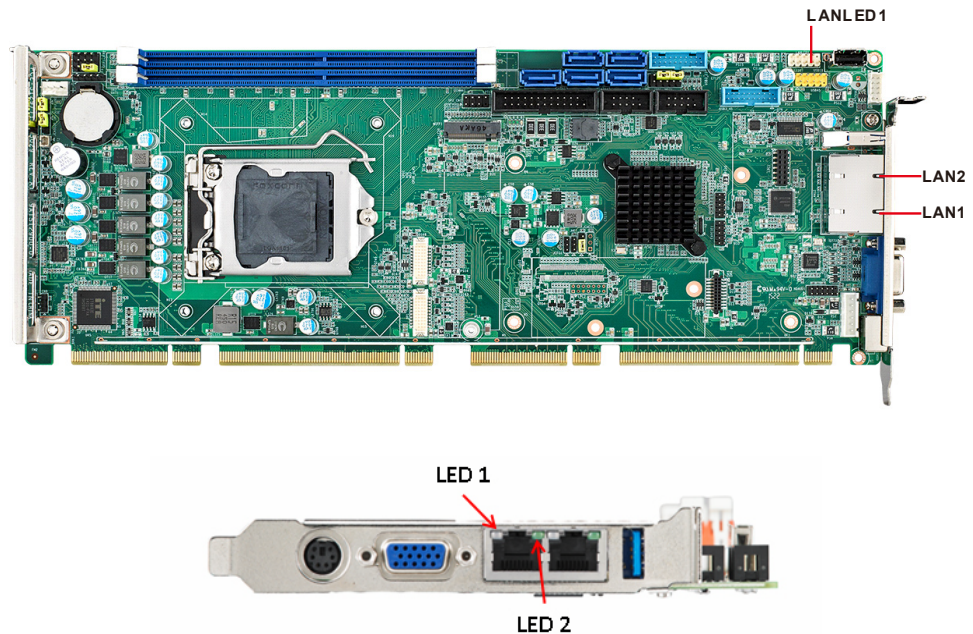

The SBC is equipped with one or two high-performance 1000 Mbps Ethernet LANs. They are supported by all major network operating systems. The RJ-45 jacks on the rear plate provide convenient connectivity.

Table 2.2: LAN LED Indicators

LAN Mode	LED1	LED2
1000Mbps Link On	Green On	On
1000Mbps Active	Green on	Flash
1000Mbps Link Off	Off	Off
100Mbps Link On	Orange On	On
100Mbps Active	Orange On	Flash
100Mbps Link Off	Off	Off
10Mbps Link On	Off	On
10Mbps Active	Off	Flash
10Mbps Link Off	Off	Off

2.11 High Definition Audio Module Interface (HDAUD1)

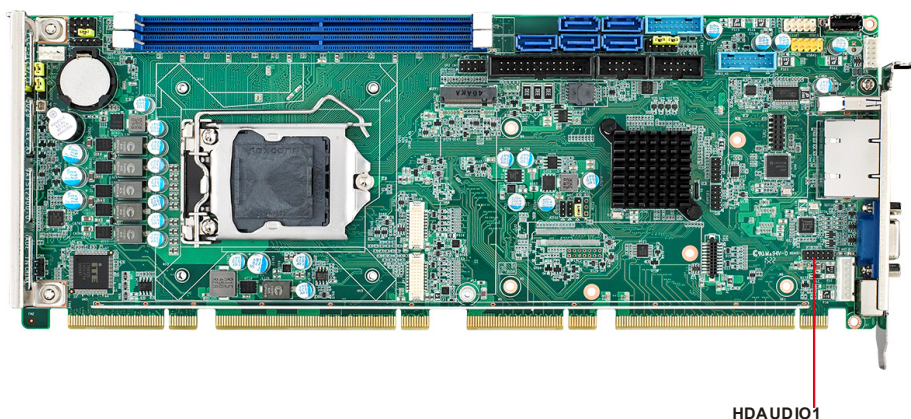

This HDAUD1 pin header is the connection interface to Advantech's high definition audio module.

Note! *Advantech high definition audio module ordering information.*



P/N: PCA-AUDIO-HDA2E

2.12 GPIO Header (GPIO1)

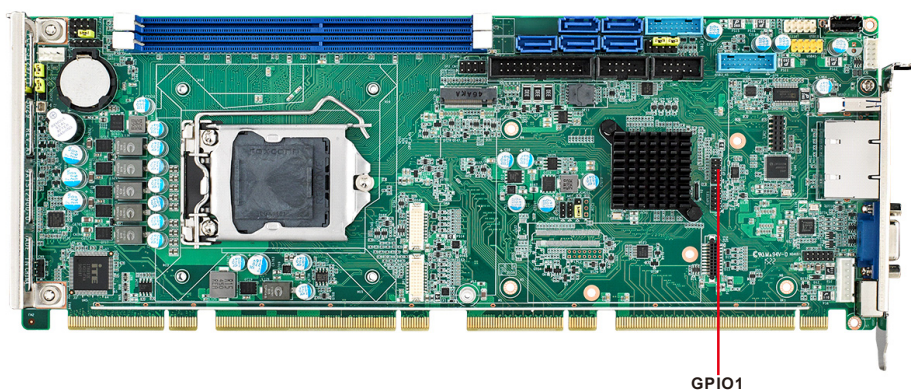

Provides 10-pin header connector for 8-bit Digital I/O usage. Refer to Appendix B for detailed information on the pin assignments and programming guide in Appendix C.

2.13 Case Open Connector (JCASE1 and JCASEOP_SW1)

The SBC supports Case Open with both Normally Open (N.O.) and Normally Closed(N.C.) mode. Please follow below directions to install Case Open for your system.

1. Please consult with your chassis provider for which Case Open mode is supported.
2. Please refer to Table 1 setting JCASWOP_SW1 jumper at correct position.
3. Please enable Case Open warning in the BIOS menu. (BIOS menu: Advanced->H/W Monitor).

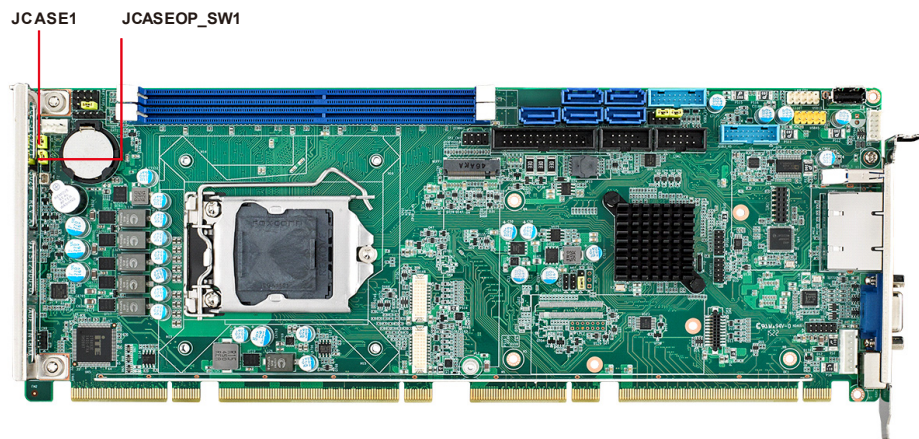

Figure 2.1 Case Open Jumper Locations

The 2-pin case open connector is for chassis with a case open sensor. When the case is open, the buzzer on motherboard will beep.

Table 2.3: Case open mode Jumper

Case open mode/JCASE1	JCASEOP_SW1
Normally Open(N.O.)	2-3 pin short
Normally Closed(N.C.)	1-2 pin short

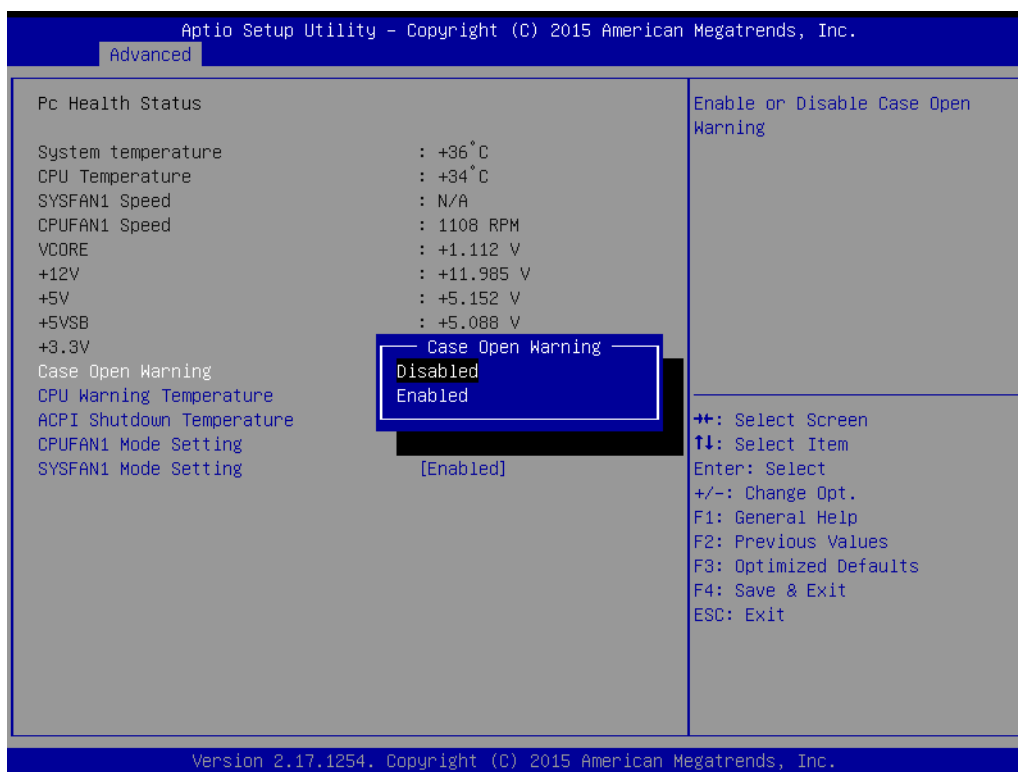
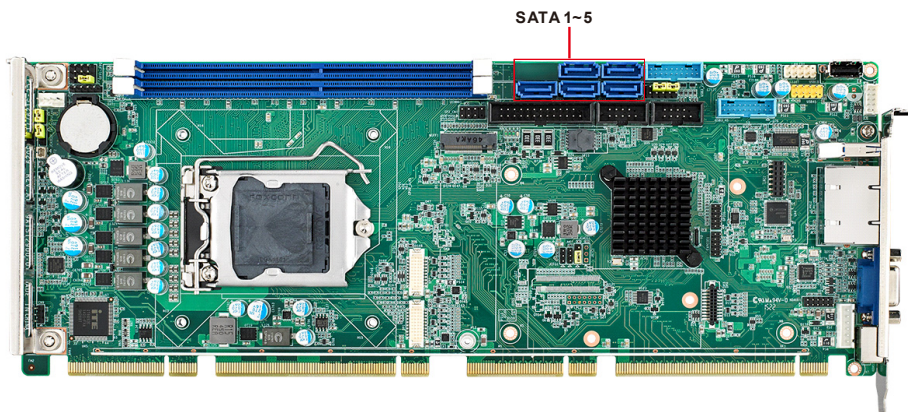

Figure 2.2 Case Open Warning in BIOS Menu

2.14 Serial ATA Interface (SATA1~SATA5)



The PCE-7129/5129/5029 features high performance serial ATA interface (5*600MB/s) which eases cabling to hard drivers or CD/DVD drivers with long cables. These five on-board SATA ports can be configured as RAID 0, 1, 10, or 5. Please see the detailed BIOS setting instructions for this in Chapter 3.

2.15 LPC Extension Interface (LPC1)

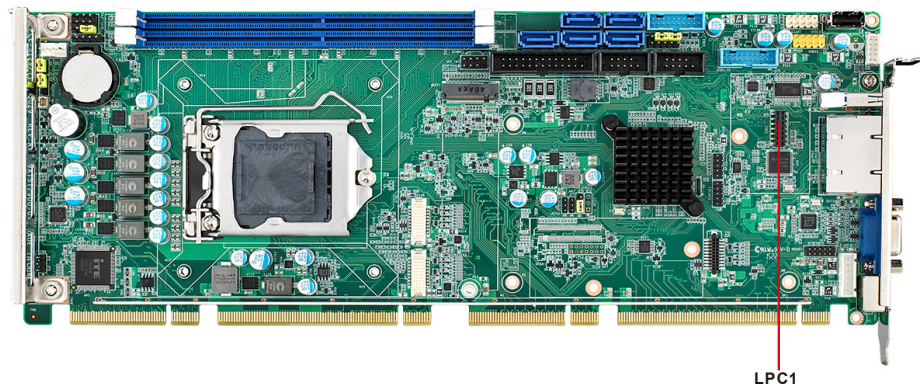

LPC1 is a 14-pin female pin header for connection with an Advantech LPC module.

Chapter 3

AMI BIOS Setup

3.1 Introduction

With the AMI BIOS Setup program, you can modify BIOS settings and control the special features of your computer. The Setup program uses a number of menus for making changes and turning the special features on or off. This chapter describes the basic navigation of the PCE-7129/5129/5029 setup screens.

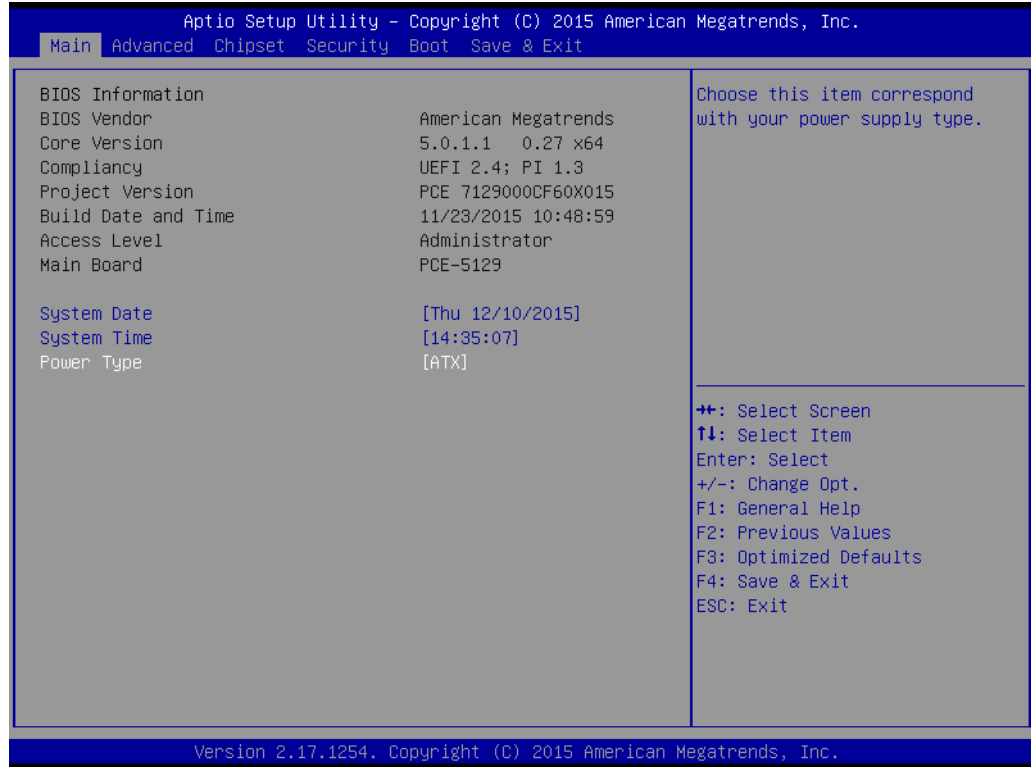

Figure 3.1 Setup program initial screen

3.2 Entering Setup

Turn on the computer and the BIOS is activated as well. The setup program can be triggered by pressing "DEL" or "ESC" key.

Note! *If the message disappears before you press the "DEL" or "ESC" key, please restart the computer and try it again.*



3.2.1 Main Setup

When you first enter the BIOS Setup Utility, you will enter the Main setup screen. You can always return to the Main setup screen by selecting the Main tab. There are two Main Setup options. They are described in this section. The Main BIOS Setup screen is shown below.



Figure 3.2 Main setup screen

The Main BIOS setup screen has two main frames. The left frame displays all the options that can be configured. Grayed-out options cannot be configured; options in blue can. The right frame displays the key legend.

Above the key legend is an area reserved for a text message. When an option is selected in the left frame, it is highlighted in white. Often a text message will accompany it.

- **System Time / System Date**

Use this option to change the system time and date. Highlight System Time or System Date using the <Arrow> keys. Enter new values through the keyboard. Press the <Tab> key or the <Arrow> keys to move between fields. The date must be entered in MM/DD/YY format. The time must be entered in HH:MM:SS format.

- **Power Type**

Choose this item correspond with your power supply type.

3.2.2 Advanced BIOS Features Setup

Select the Advanced tab from the PCE-7129/5129/5029 setup screen to enter the Advanced BIOS Setup screen. You can select any of the items in the left frame of the screen, such as CPU Configuration, to go to the sub menu for that item. You can display an Advanced BIOS Setup option by highlighting it using the <Arrow> keys. All Advanced BIOS Setup options are described in this section. The Advanced BIOS Setup screen is shown below, and the sub menus are described on the following pages.

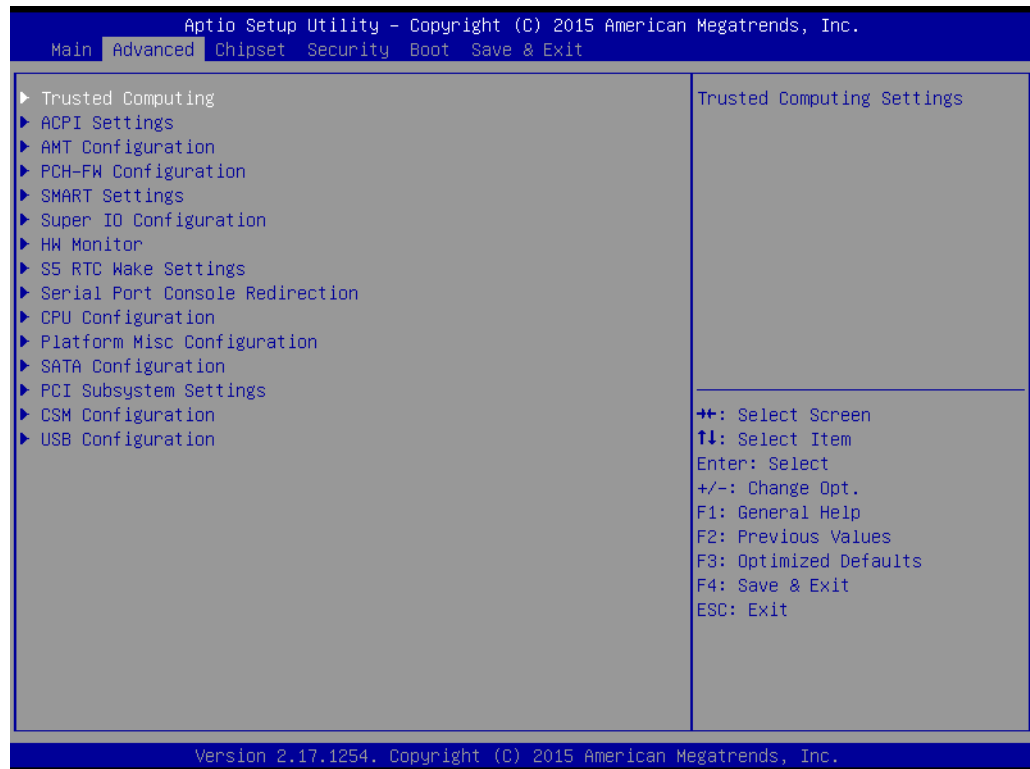

Figure 3.3 Advanced BIOS features setup screen

3.2.2.1 Trust Computing

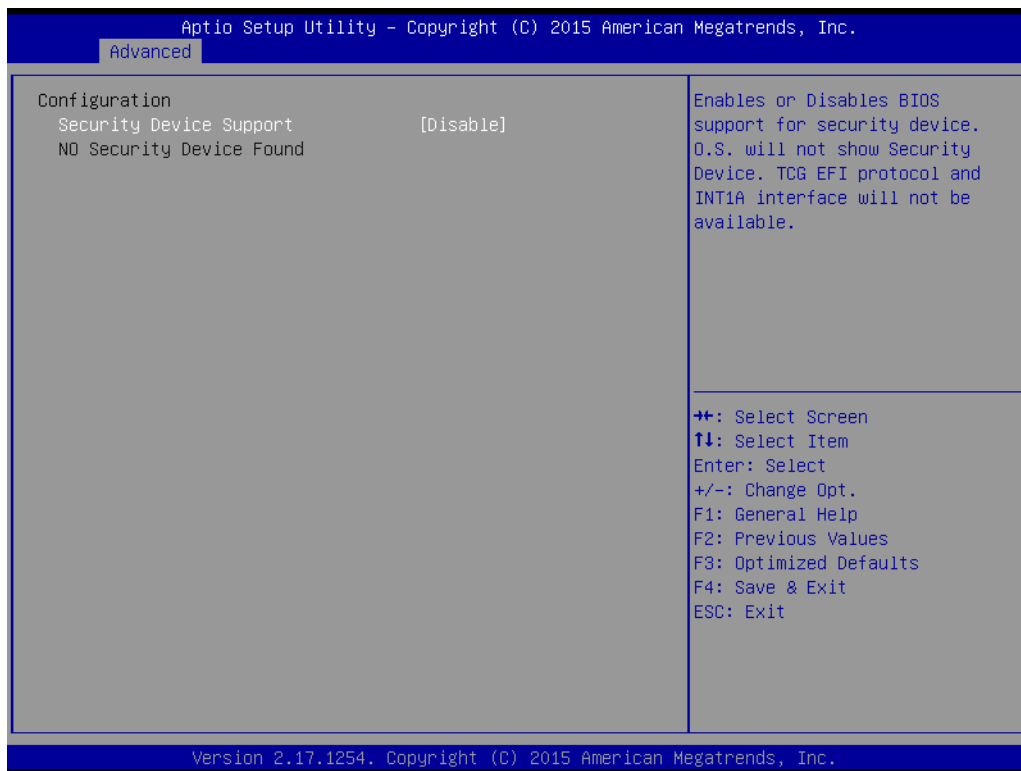

Figure 3.4 Trust Computing

- **Security Device Support**

Enable or disable BIOS for security device support. You can purchase Advantech TPM (Trust Platform Module) PCA-TPM-00A1E for your security device.

Note! *TCG EFI protocol and INT1A interface will not be available.*



3.2.2.2 ACPI Settings

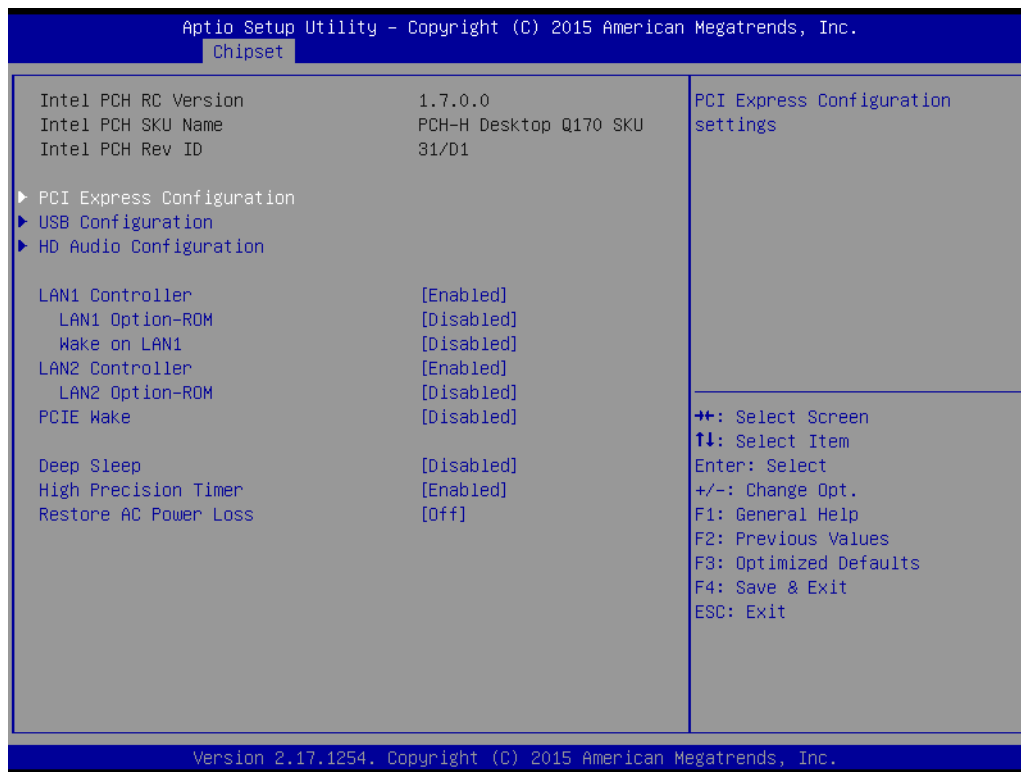

Figure 3.5 ACPI Settings

- **Enable ACPI Auto Configuration**
Enable or disable BIOS ACPI Auto Configuration
- **Enable Hibernation**
"Enable or disable" Hibernate (OS/S4 Sleep State). This option may not be effective with some OS.
- **Lock Legacy Resources**
Enables or disables Lock Legacy Resources.
- **PowerOn by Modem**
"Enabled" or "Disabled" PowerOn by Modem

3.2.2.3 AMT Configuration

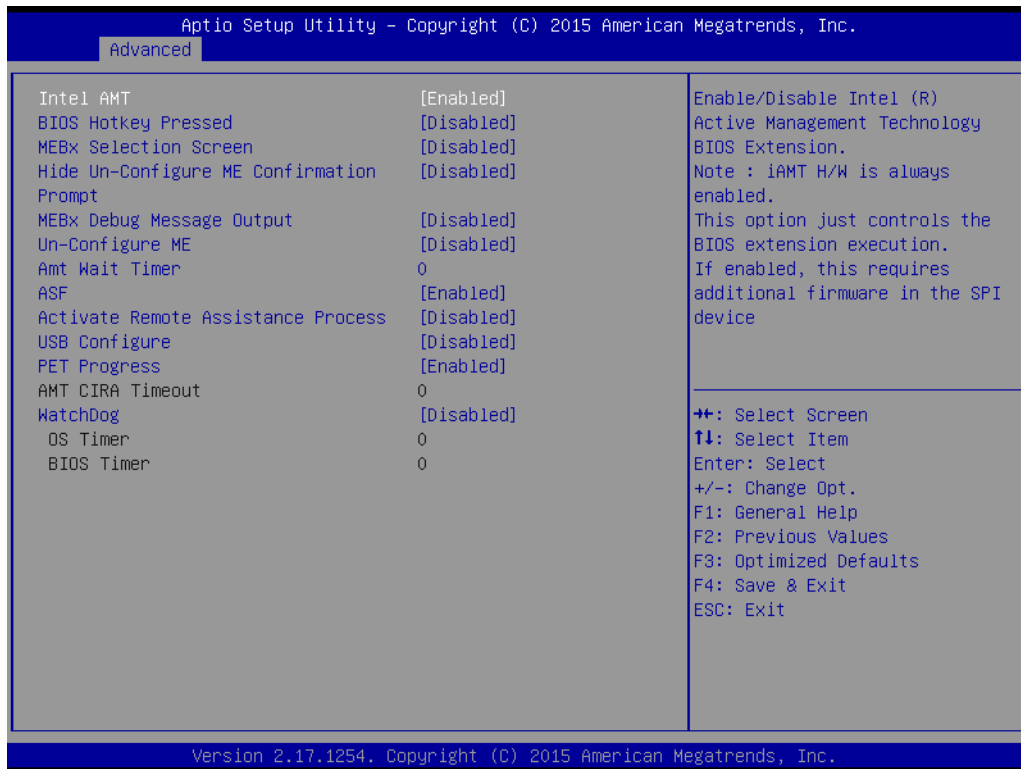

Figure 3.6 AMT Configuration

- **Intel AMT**

Enable/Disable Intel Active Management Technology.

Note! *iAMT H/W is always enabled. This option controls the BIOS extension execution. If enabled, this requests additional firmware in the SPI device.*



PCE-5029 series product dont support Intel AMT function.

- **BIOS Hotkey Pressed**

Enable/Disable BIOS hotkey press.

- **MEBx Selection Screen**

Enable/Disable MEBx selection screen.

- **Hide Un-Configure ME Confirmation**

Hide un-configured ME without password confirmation prompt.

- **MEBx Debug Message Output**

Enable MEBx debug message output.

- **Un-Configure ME**

Un-configure ME without password.

- **Amt Wait Timer**

Set timer to wait before sending ASF_GET_Boot_Options.

- **ASF**

Enable/Disable alert specification format.

- **Active Remote Assistance Process**

Trigger CIRA boot.

- **USB Configure**

Enable/Disable USB configure function.

- **PET Progress**

User can Enable/Disable PET events progress to receive PET events or note.

- **WatchDog**

Enable/Disable Watchdog Timer

3.2.2.4 PCH-FW Configuration

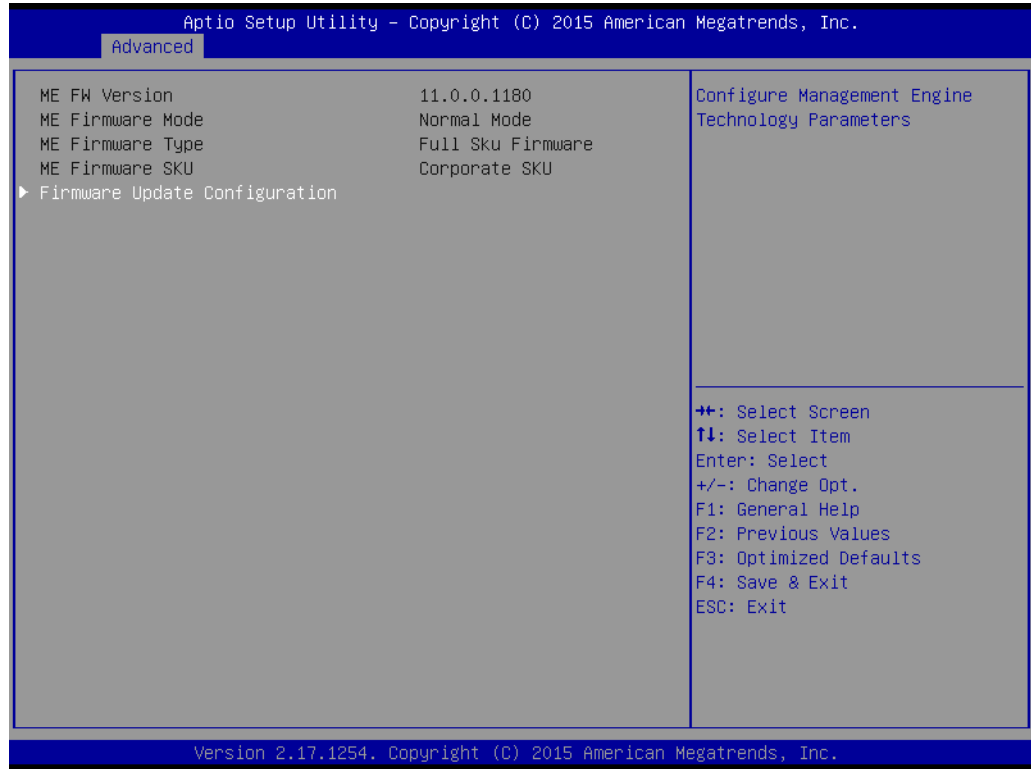

Figure 3.7 Firmware Update Configuration

- **ME FW Image Re-Flash**
Enable/Disable ME FW Image Re-Flash function.

3.2.2.5 Smart Setting

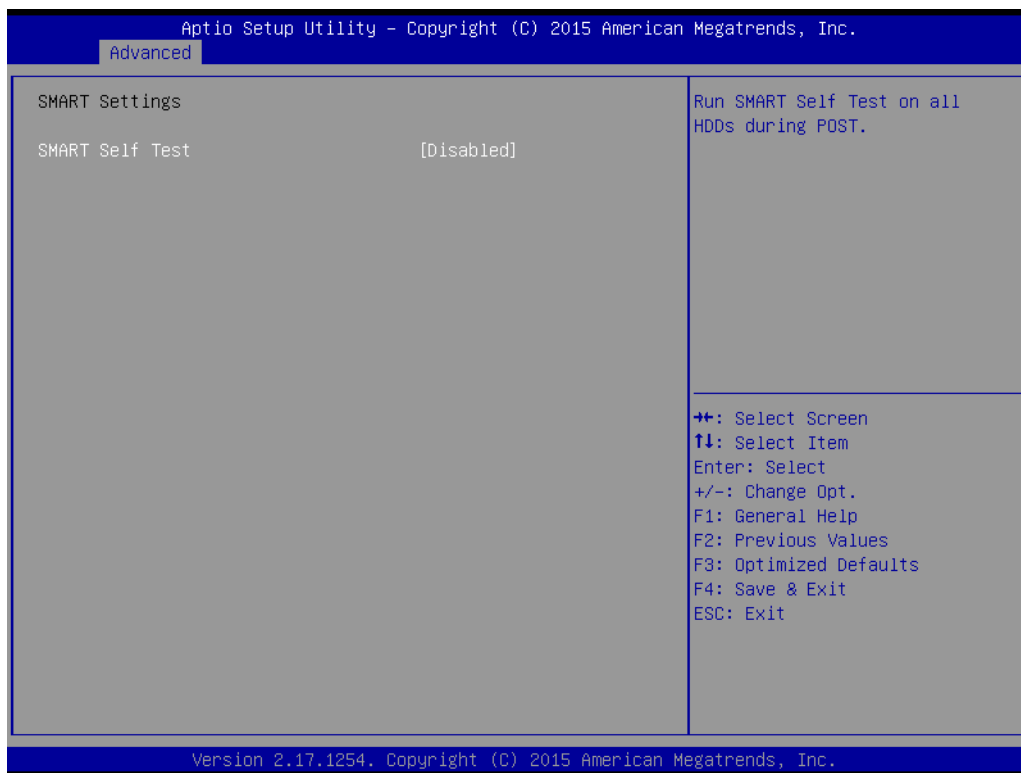

Figure 3.8 Smart Setting

- **Smart self test**
Run SMART self test on all HDDs during POST.

3.2.2.6 Super IO Configuration

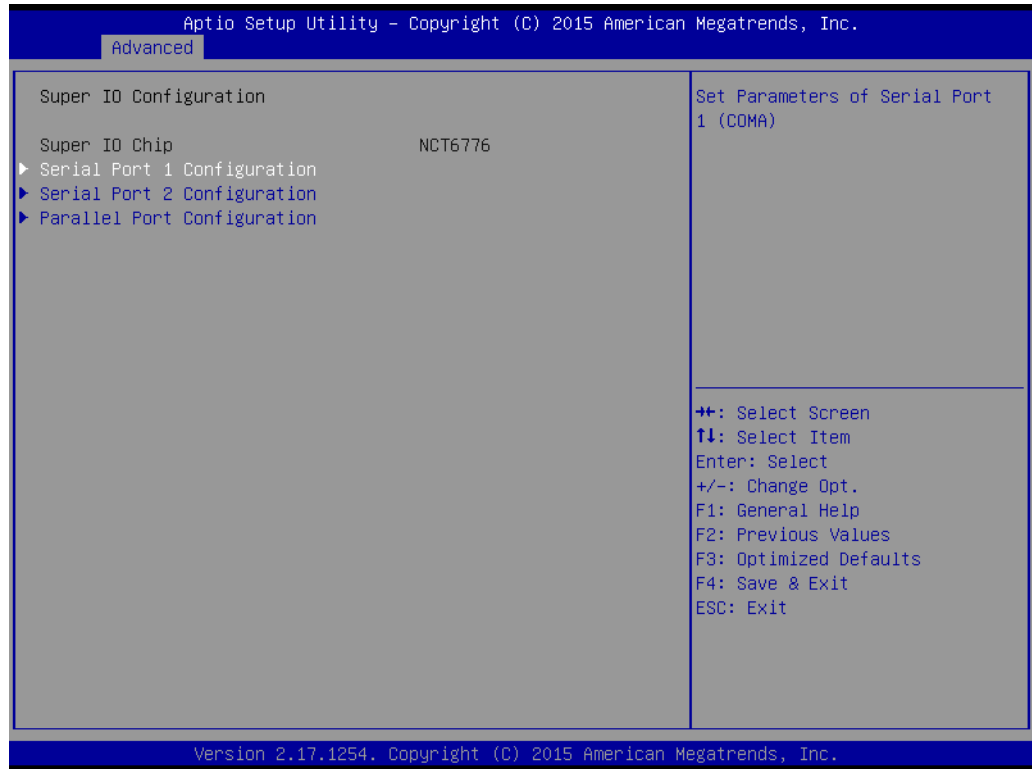

Figure 3.9 Super IO Configuration

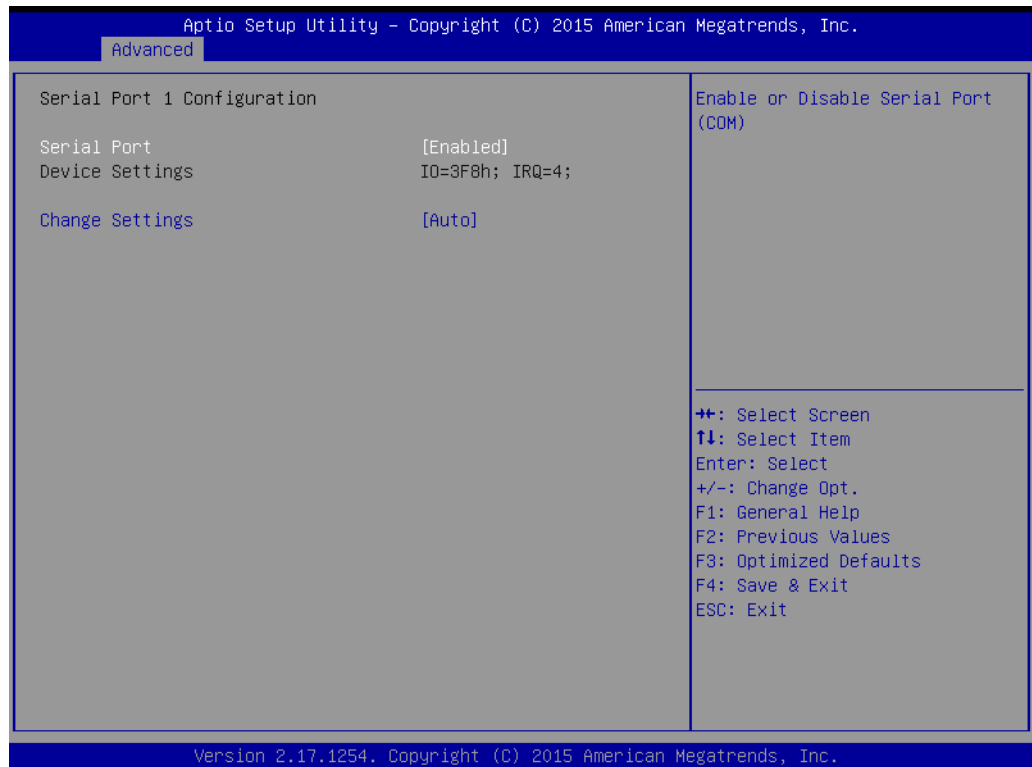

Figure 3.10 Serial Port 1 or 2 Configuration

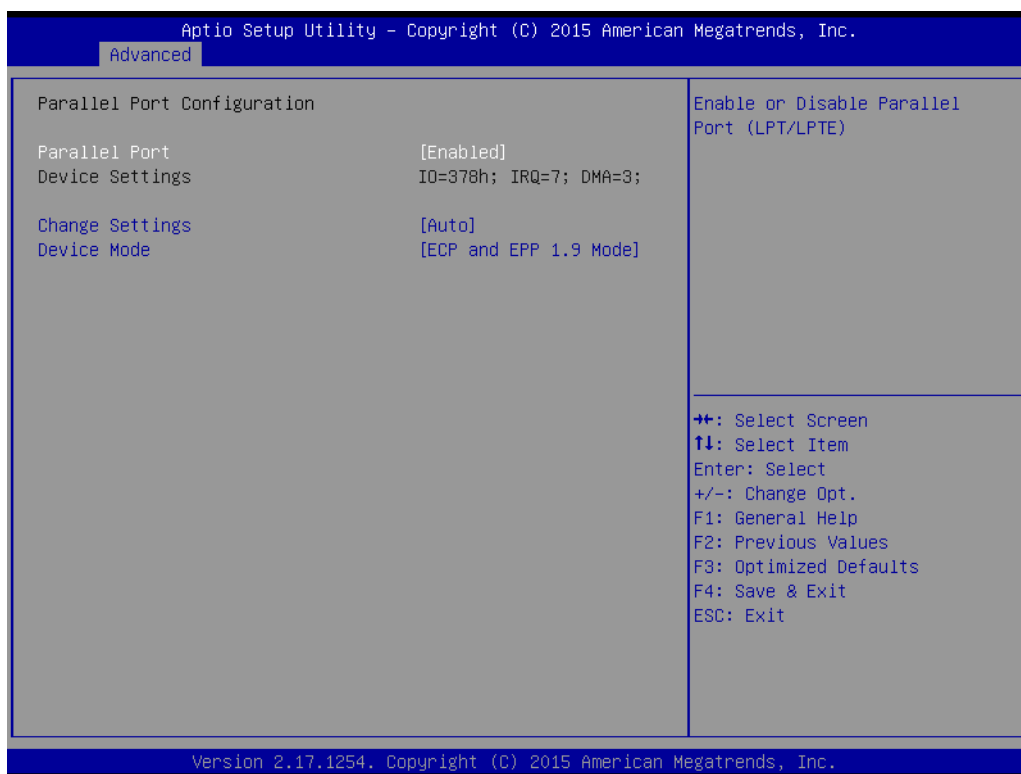

Figure 3.11 Parallel Configuration

- **Serial Port 1 -2 configuration**
"Enable or Disable" serial port
- **Parallel Port configuration**
"Enable or Disable" parallel port

3.2.2.7 H/W Monitor

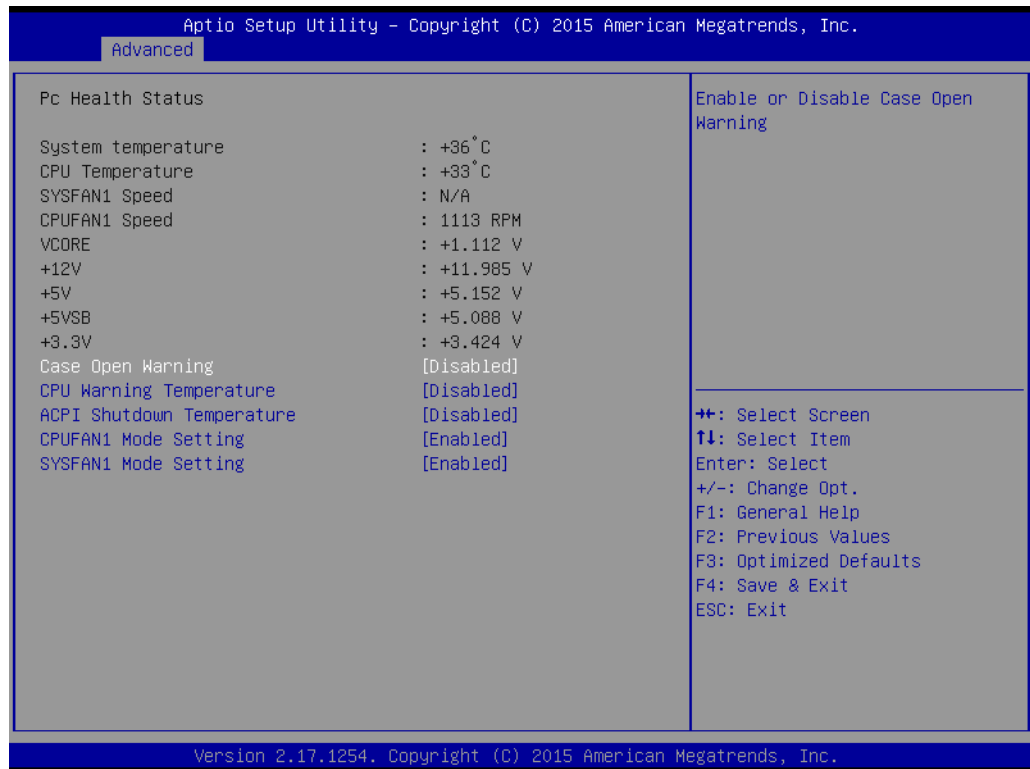

Figure 3.12 PC Health Status

- **Case Open Warning**
Enable/Disable the chassis Intrusion monitoring function. When enabled and the case is opened, the speaker beeps.
- **CPU Warning Temperature**
Use this to set the CPU warning temperature threshold. When the system reaches the warning temperature, the speaker will beep.
- **ACPI Shutdown Temperature**
Use this to set the ACPI shutdown temperature threshold. When the system reaches the shutdown temperature, it will be automatically shut down by ACPI OS to protect the system from overheating damage.
- **CPUFAN1 Mode Setting**
Enable/Disable Smart Fan.
- **SYSFAN1 Mode Setting**
Enable/Disable Smart Fan

3.2.2.8 S5 RTC Wake Setting

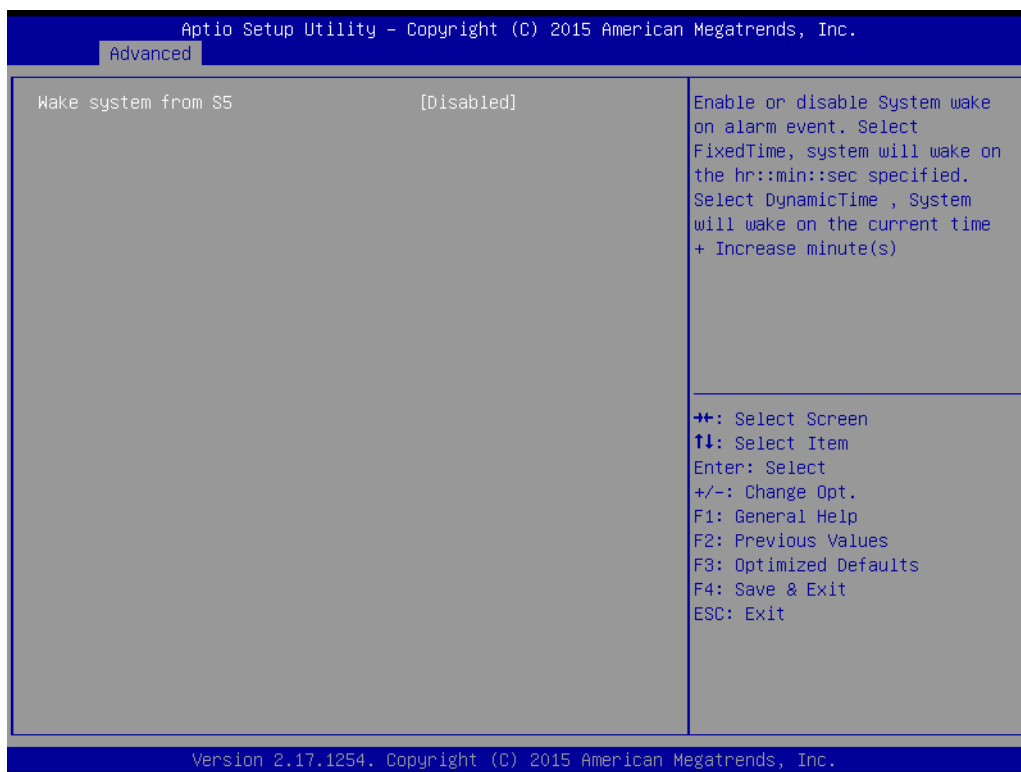

Figure 3.13 S5 RTC configuration

■ Wake System with Fixed Time

Enable or disable system wake on alarm event. Select fixed time, system will wake on the hr:min:sec as specified. Select dynamic time, system will wake on the current time.

Note! "+" increase minute(s).



3.2.2.9 Serial Port console redirection

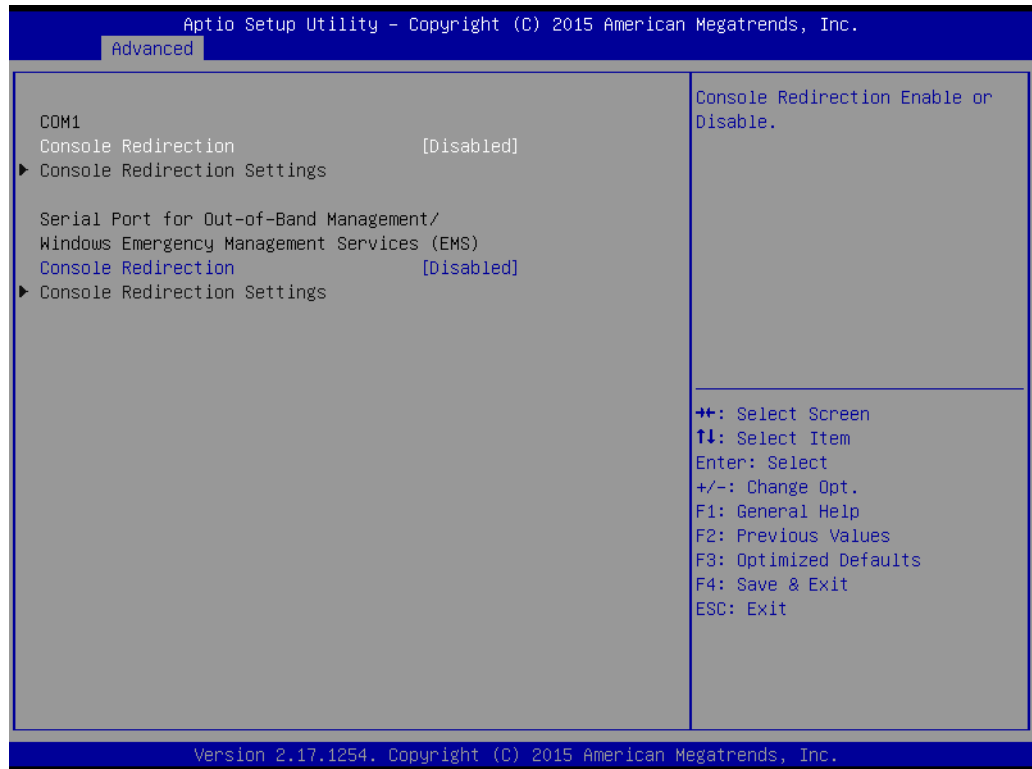

Figure 3.14 Serial Port console redirection

- **COM1**
 - **Console Redirection Settings**
 - Console Redirection Enable or Disable
- **Serial Port for Out-of-Band Management/ Windows Emergency Management services (EMS)**
 - **Console Redirection**
 - Console Redirection Enable or Disable

3.2.2.10 CPU Configuration

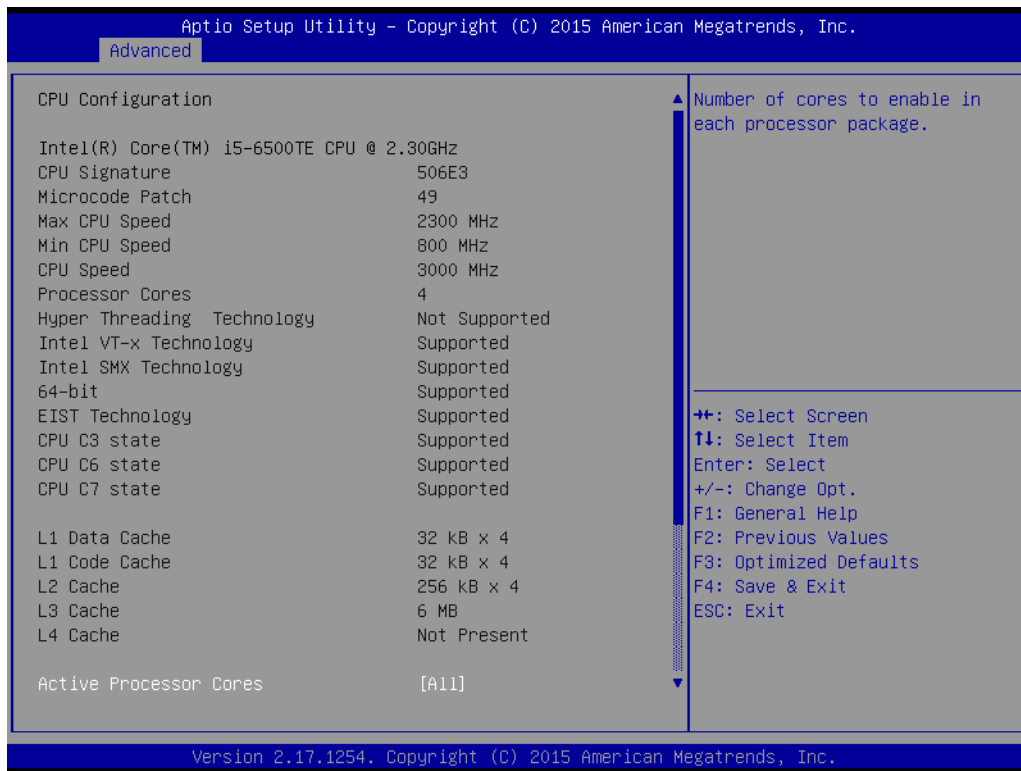

Figure 3.15 CPU Configuration

- **Active Processor Core**
Use this item to select the number of processor cores you want to activate when you are using a dual or quad core processor.
- **Intel Virtualization Technology**
This feature is used to "Enable or Disable" the Intel Virtualization Technology (IVT) extension. It allows multiple operating systems to run simultaneously on the same system by creating virtual machines, each running its own x86 operating system.
- **Hardware Prefetcher**
Hardware Prefetcher is a technique that fetches instructions and/or data from memory into the CPU cache memory well before the CPU needs it to improve the load-to-use latency. You may choose to "Enable or Disable" it.
- **Adjacent Cache Line Prefetch**
The Adjacent Cache-Line Prefetch mechanism, like automatic hardware prefetch, operates without programmer intervention. When it is enabled through the BIOS, two 64-byte cache lines are fetched into a 128-byte sector, regardless of whether the additional cache line has been requested or not. You may choose to "Enable or Disable" it.
- **CPU AES**
"Enable or Disable" CPA advanced encryption standard instruction.
- **Boot Performance**
Select the performance state that the BIOS will set before OS handoff.
- **Intel(R) Speedstep(tm)**
Allows more than two frequency ranges to be supported.
- **CPU C states**
Intel C states setting for power saving.

- **Intel TXT(LT) Support**
Enable or Disable Intel TXT support

3.2.2.11 Platform Misc Configuration

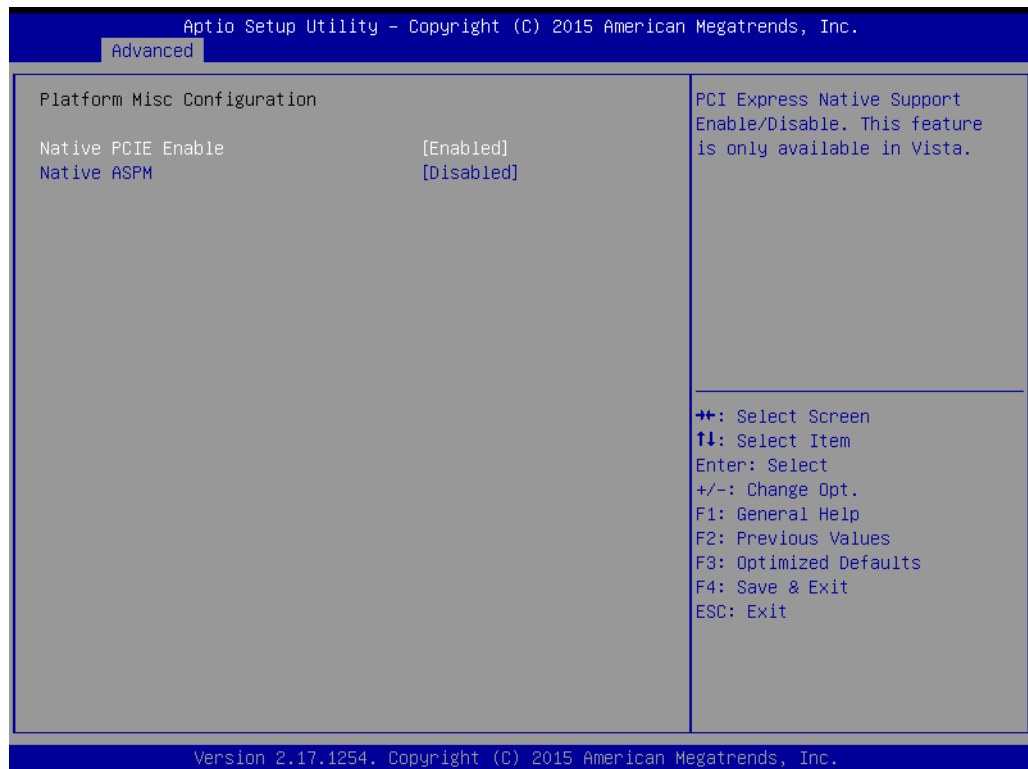

Figure 3.16 Platform Misc Configuration

- **Native PCIE Enable**
PCI Express Native Support Enable/Disable. This is only available in Vista.
- **Native ASPM**
On enable, Vista will control the ASPM support for the device. If disabled, the BIOS will.

3.2.2.12 SATA Configuration

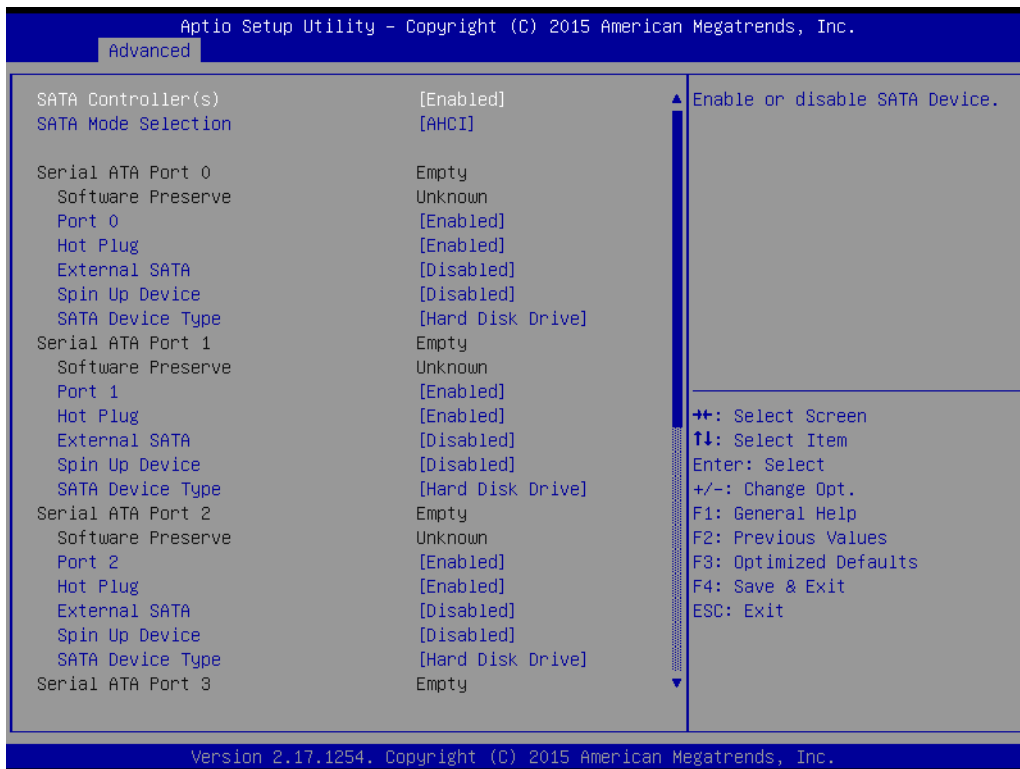
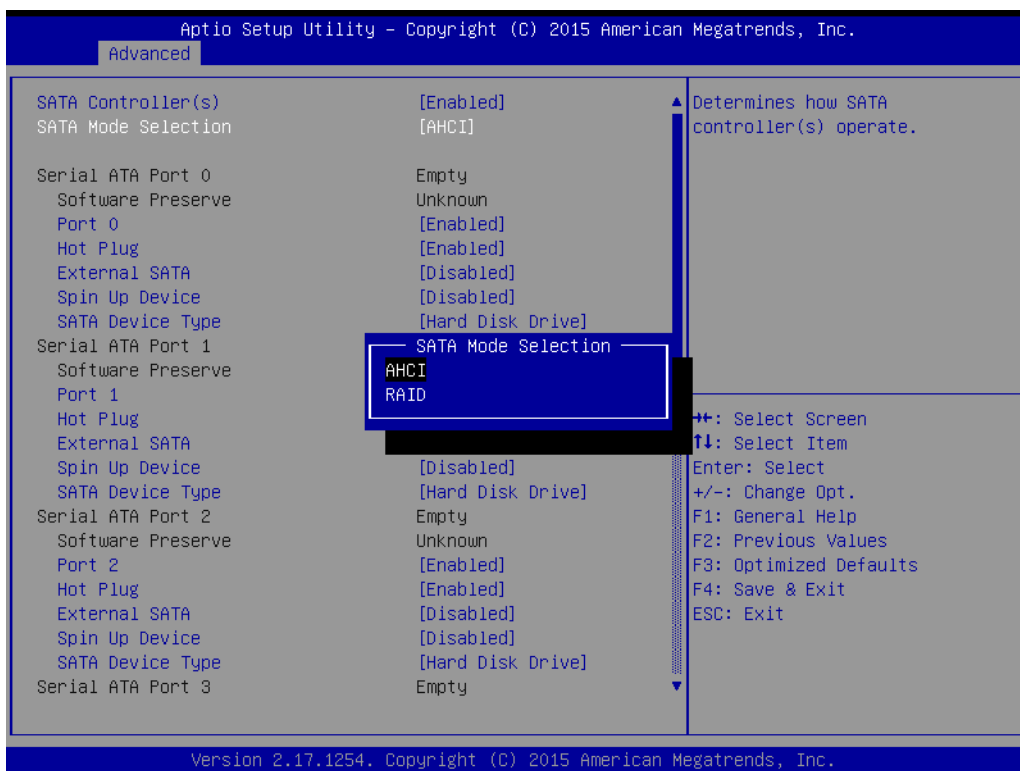

Figure 3.17 SATA Configuration

- **SATA Controller(s)**
Enable or disable SATA Device
- **SATA Mode**
This can be configured as AHCI and RAID



- **Port 0~5**
To enable or disable SATA port 0~5.
- **Hot Plug**
Enable/Disable SATA Hot-Plug
- **Spin up Device**
Enable/disable spin up device
- **Port 0~5 Device Type**
To identify the SATA that is connected to a Solid State or Hard Disk Drive.

3.2.2.13 PCI Subsystem Settings

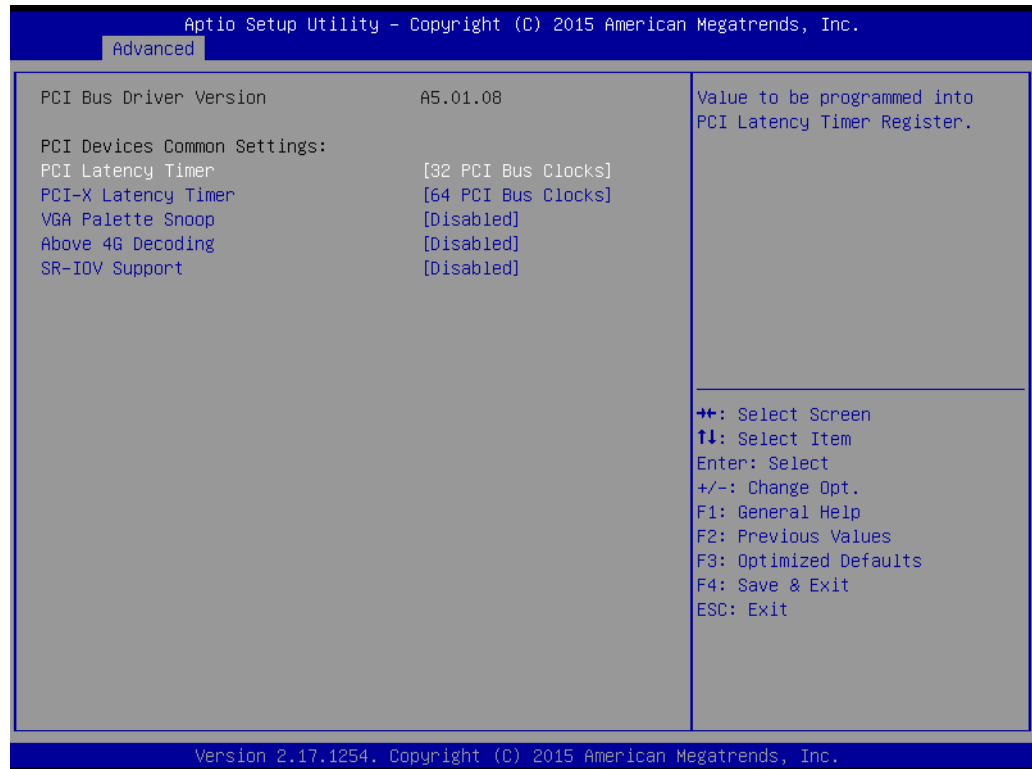

Figure 3.18 PCI Subsystem Settings

- **PCI Common Settings**
- **PCI Latency Timer**
Value to be programmed into PCI Latency Timer Register.
- **PCI-X Latency Timer**
Value to be programmed into PCI-X Latency Timer Register.
- **VGA Palette Snoop**
Enables/Disables VGA palette registers snooping.
- **Above 4G Decoding**
Enable / disable above 4G decoding
- **SR-IOV Support**
Enable / disable SR-IOV Support

3.2.2.14 CSM Configuration

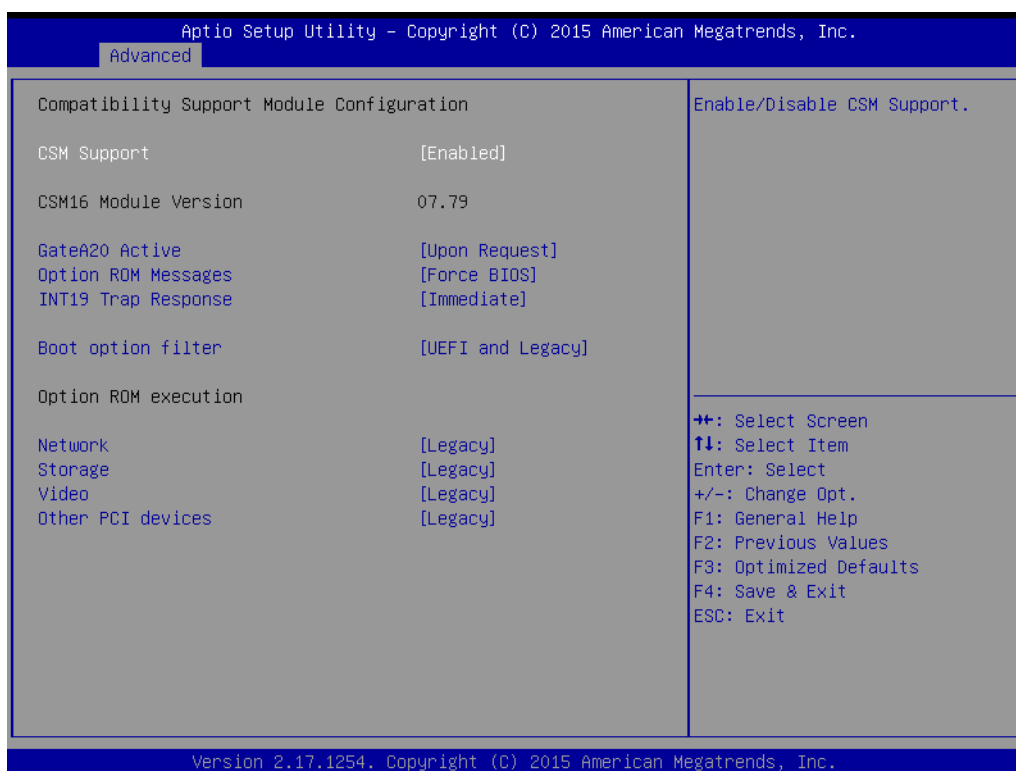

Figure 3.19 PCI Express Settings

- **Compatibility Support Module Configuration**
 - **CSM Support**
Enable/Disable CSM Support.
- **CSM16 Module Version**
 - **GateA20 Active**
Upon Request - GA20 can be disabled using BIOS services. Always - do not allow disabling GA20; this option is useful when any RT code is executed above 1MB.
 - **Option ROM Message**
Set display mode for Option ROM.
 - **INT19 Trap Response**
BIOS reaction on INT19 trapping by Option ROM: Immediate - execute the trap right away; Postponed - execute the trap during legacy boot.
 - **Boot option filter**
This option controls Legacy/UEFI ROMs Priority.
- **Option ROM execution**
 - **Network**
Controls the execution of UEFI and Legacy PXE OpROM.
 - **Storage**
Controls the execution of UEFI and Legacy Storage OpROM.
 - **Video**
Controls the execution of UEFI and Legacy Video OpROM.
 - **Other PCI devices**
Determines OpROM execution policy for devices other than Network, Storage, or Video.

3.2.2.15 USB Configuration

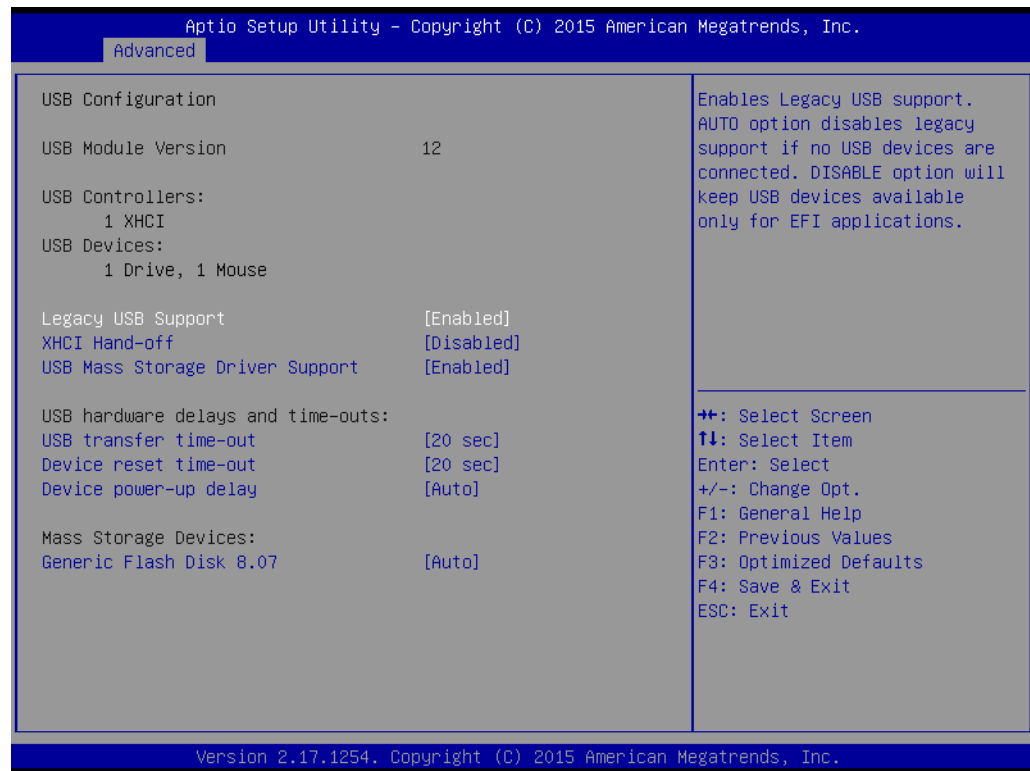

Figure 3.20 USB Configuration

- **Legacy USB Support**
This is for USB device support under legacy OS such as DOS. When choosing "AUTO", the system will automatically detect if any USB device is plugged into the computer and enable USB legacy mode when a USB device is plugged in, and disable USB legacy mode when no USB device is plugged in.
- **XHCI Hand-off**
This is a workaround for OS without XHCI hand-off support. The XHCI ownership change should be claimed by XHCI driver.
- **USB Mass Storage Driver Support**
Enable/Disable USB Mass Storage Driver Support.
- **USB transfer time-out**
Allows you to select the USB transfer time-out value. [1,5,10,20sec].
- **Device reset time-out**
Allows you to select the USB device reset time-out value. [1,5,10,20sec].
- **Device power-up delay**
This item appears only when you set device power-up delay item to [manual].
- **Mass Storage Devices**

3.2.3 Chipset

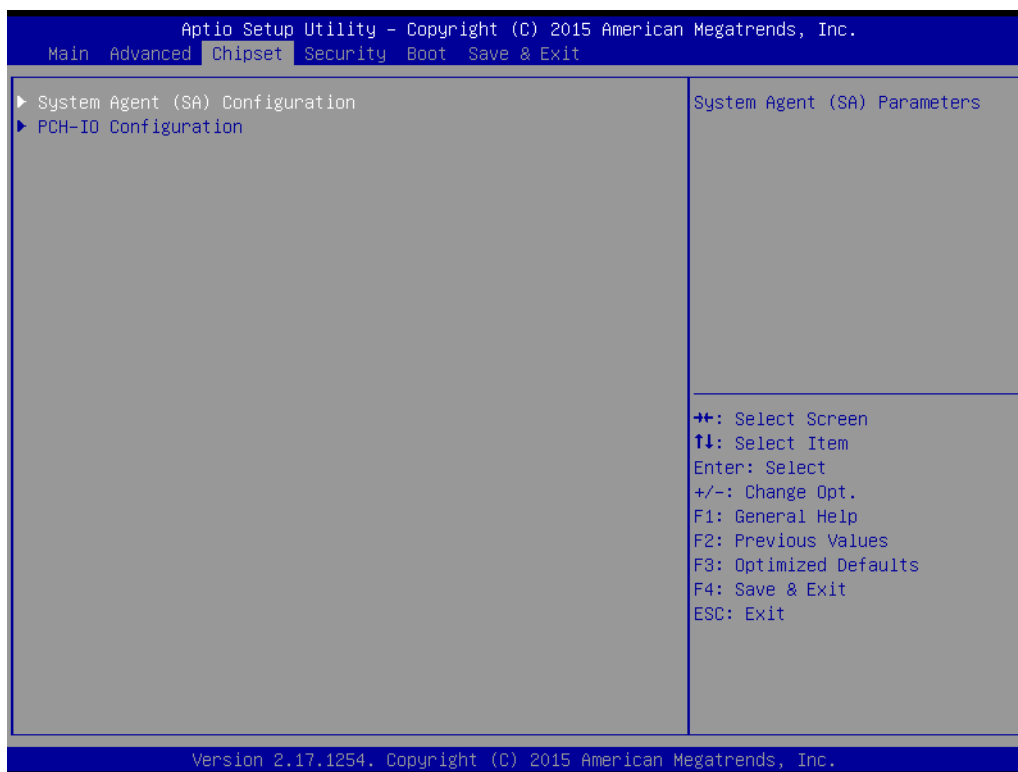

Figure 3.21 Chipset

3.2.3.1 System Agent (SA) Configuration

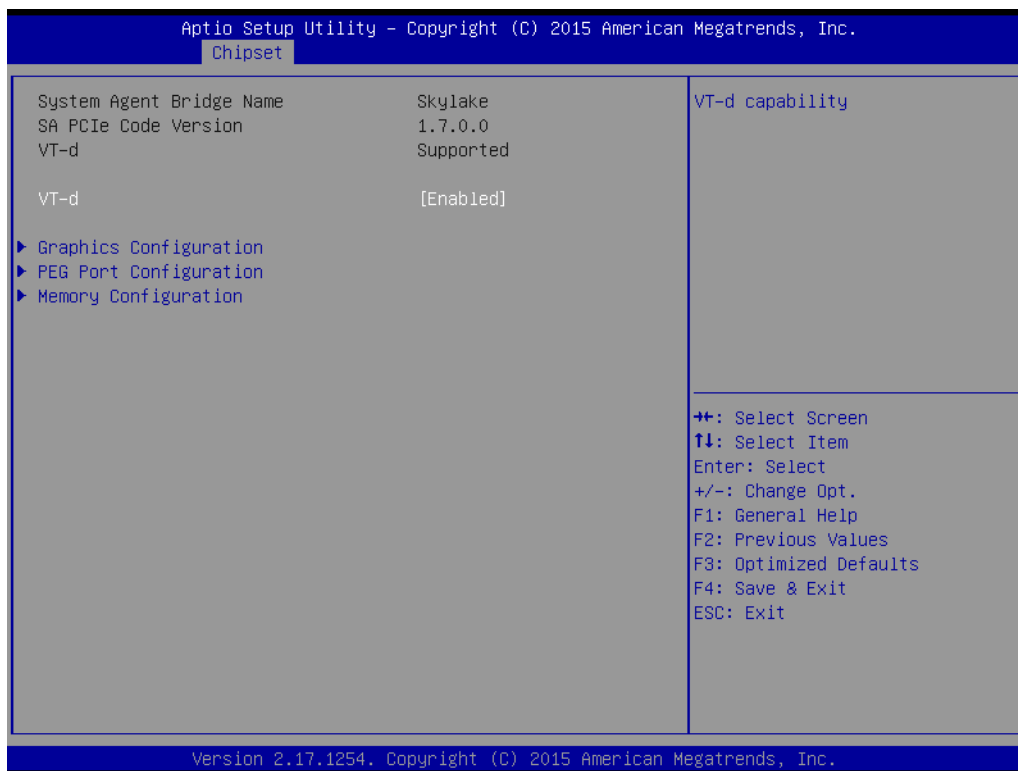
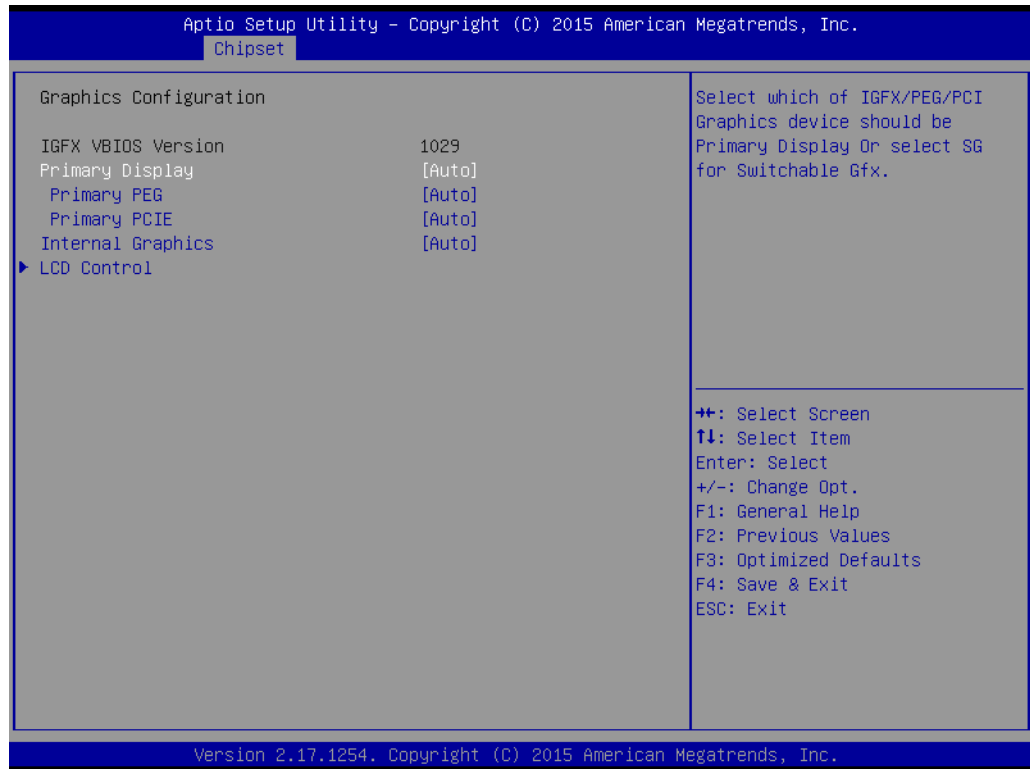

Figure 3.22 System Agent (SA) Configuration

- **VT-d**
Check to enable VT-d function on MCH.

3.2.3.2 Graphics Configuration



- **Primary Display**
Select which IGFX/PEG/PCI graphics device should be primary display or select SG for switchable GFX.
- **Primary PEG**
Select PEG0/PEG1/PEG2/PEG3 graphics device should be Primary PEG.
- **Primary PCIE**
Select Auto/ PCIE1/ PCIE2/ PCIE3/ PCIE4/ PCIE5/ PCIE6/ PCIE7 of D28: F0/ F1/ F2/ F3/ F4/ F5/ F6/ F7, PCIE8/PCIE9/PCIE10/PCIE11/PCIE12/PCIE13/ PCIE14/PCIE15 of D29: F0/ F1/ F2/ F3/ F4/ F5/ F6/ F7/, PCIE16/ PCIE17/ PCIE18/ PCIE19 of D27: F0/ F1/ F2/ F3, Graphics device should be primary PCIE.
- **Internal Graphics**
Keep IGD enabled based on the setup options.

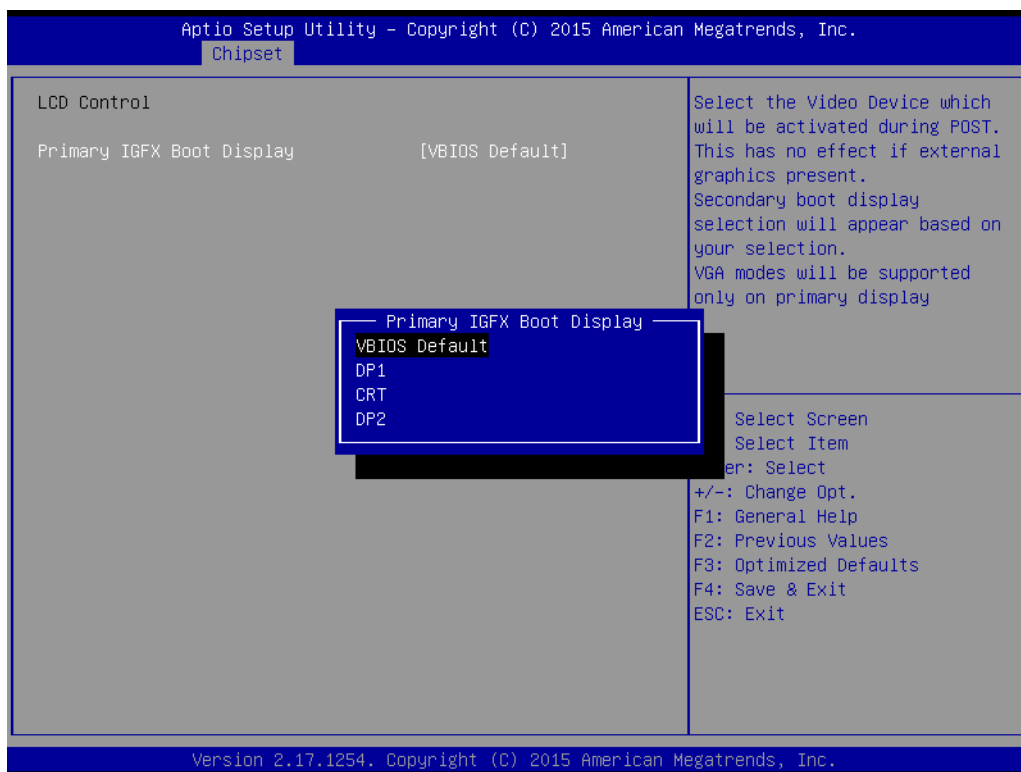

Figure 3.23 Graphics Configuration

- **LCD Control**
Select Primary IGFX Boot Display (VBIOS Default, DP1, CRT, DP2).

3.2.3.3 PEG Port Configuration

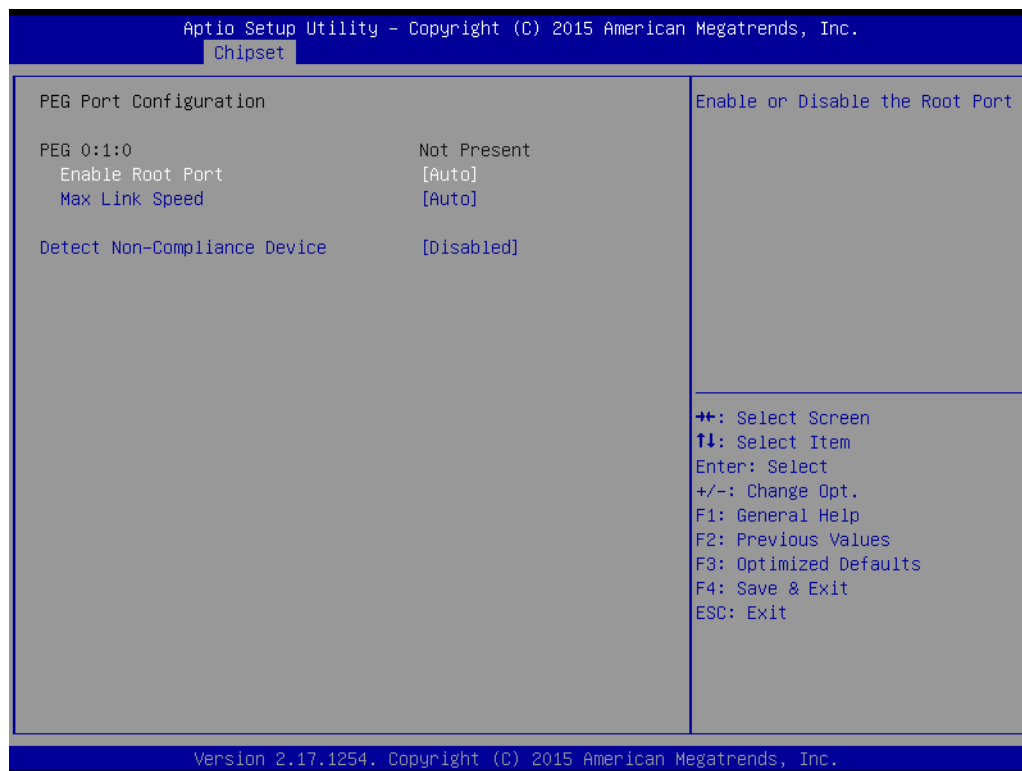

Figure 3.24 PEG Port Configuration

- **Enable Root Port**
Enable or disable the root port
- **Max Link speed**
Configure PEG 0:1:0 max speed
- **Detect Non-compliance device**
Detect Non-Compliance PCI express Device in PEG

3.2.3.4 Memory Configuration

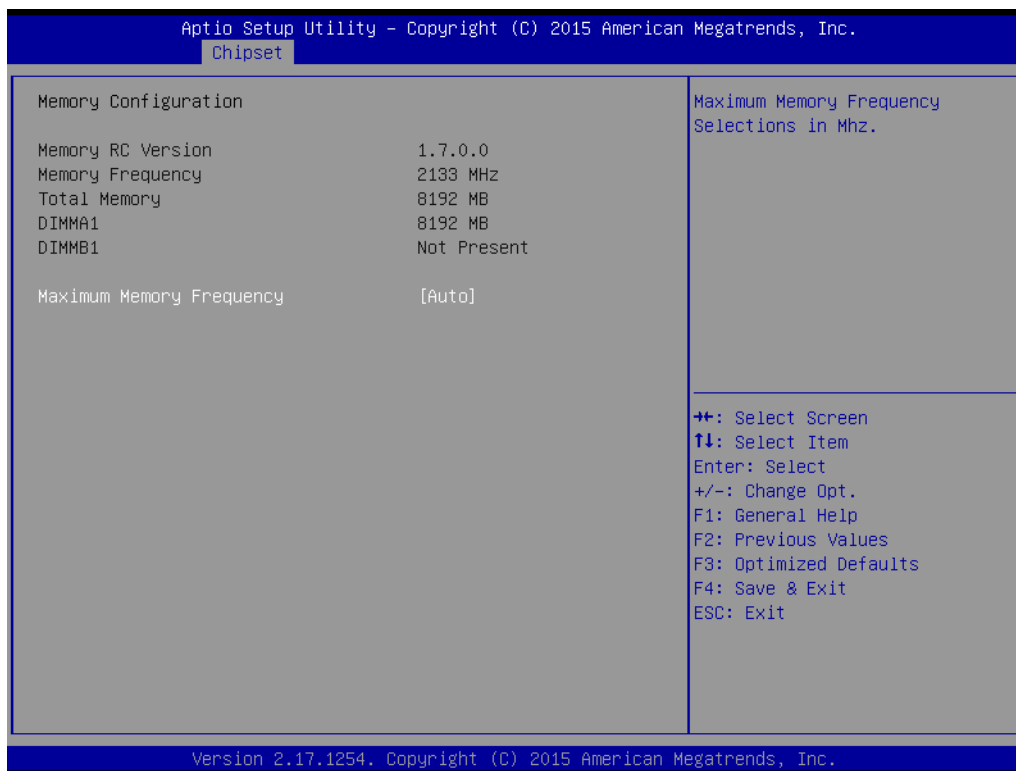

Figure 3.25 Memory Information

- **Maximum Memory Frequency**
Maximum memory frequency selections in Mhz.

3.2.3.5 PCH-IO Configuration

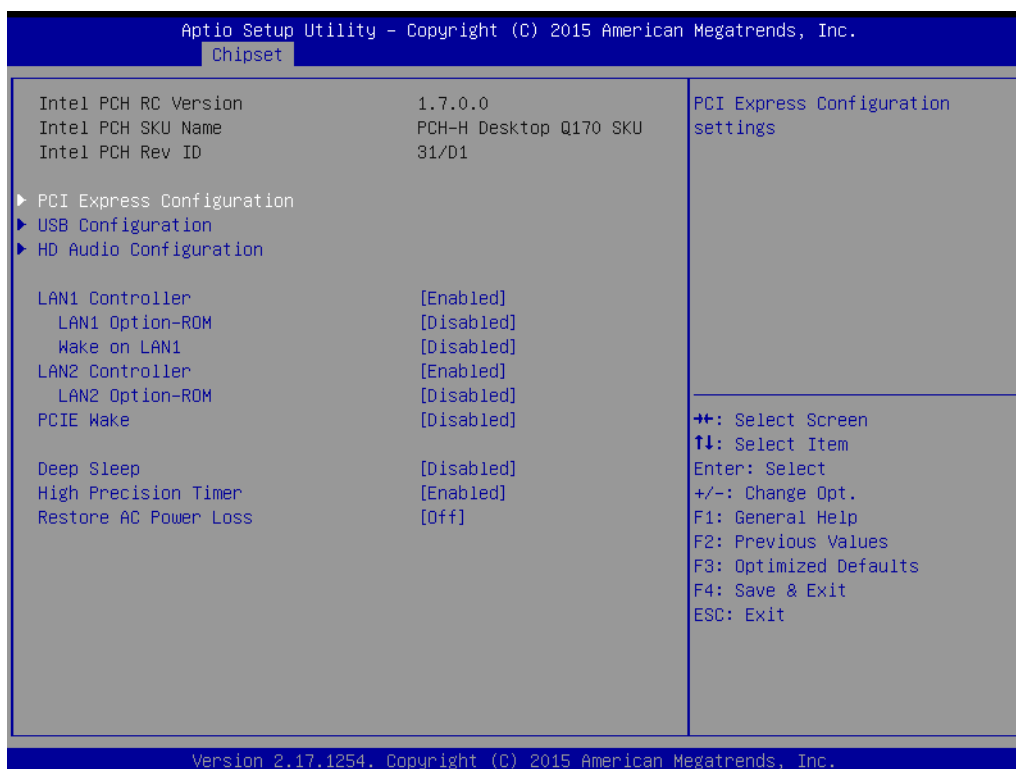

Figure 3.26 PCH IO Configuration

- **LAN1 Controller**
Enable or Disable LAN1 controller.
- **LAN 1 Option-ROM**
Enable or Disable LAN 1 boot option for legacy network devices.
- **Wake on LAN1 from S5**
Enable or Disable LAN1 to wake the system. (The wake on LAN cannot be disabled if ME is on at Sx state).
- **LAN2 Controller**
Enable or Disable LAN2 controller.
- **LAN 2 Option-ROM**
Enable or Disable LAN 2 boot option for legacy network devices.
- **PCIE Wake**
Enable or Disable PCIE to wake the system from S5.
- **High Precision Timer**
- **Restore AC Power Loss**
Power Off, Power On or last state to restore AC power loss.

3.2.3.6 PCI Express Configuration

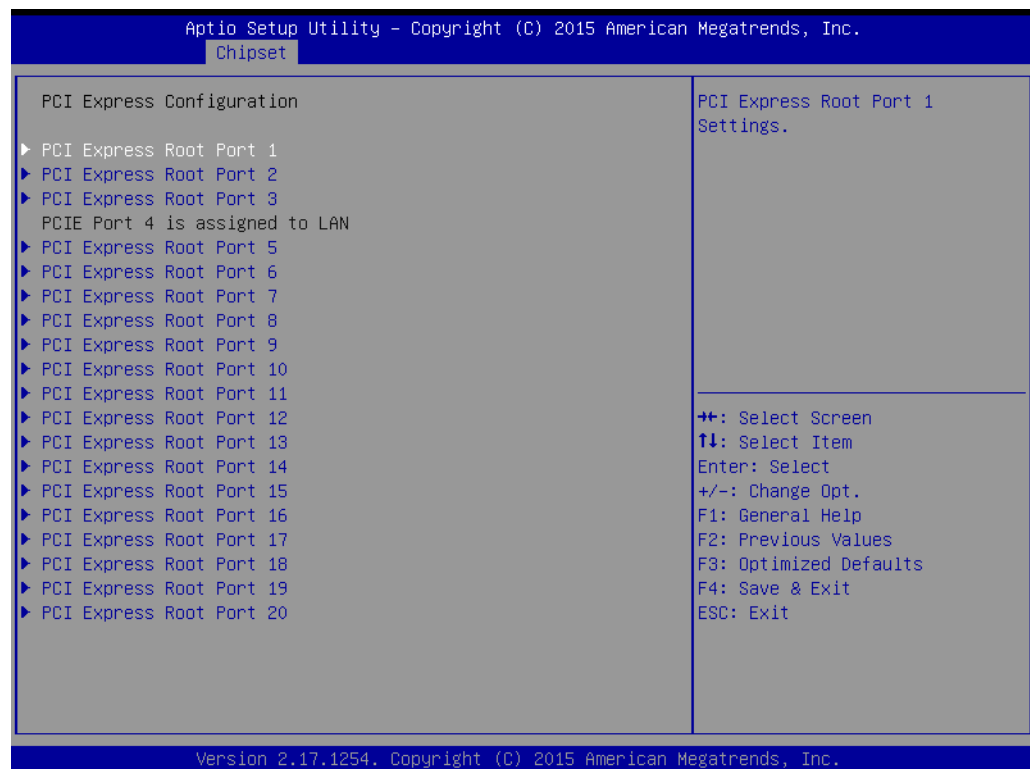

Figure 3.27 PCI Express Configuration

- **PCI Express Root Port 1~20 status**

3.2.3.7 USB Configuration



Figure 3.28 USB Configuration

- **USB Precondition**
Pre-condition work on USB host controller and root ports for faster enumeration.
- **XHCI Mode**
Select Smart auto, Auto, Enable, and Disable mode of operation of XHCI controller.

Note! *Smart auto setting remembers last setting, but auto mode does not.*



3.2.3.8 HD Audio Configuration

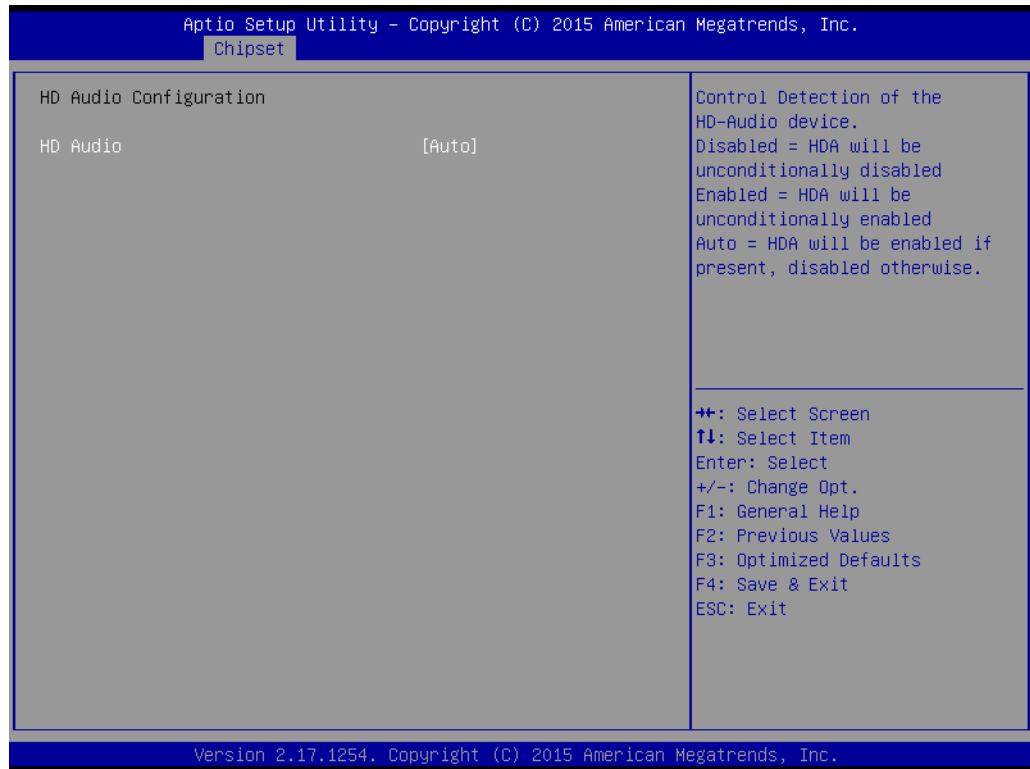

Figure 3.29 PCH Azalia Configuration

- **HD Audio**
Control detection of the HD Audio device.
Disable=HDA will be unconditionally disabled.
Enable=HDA will be unconditionally enabled.
Auto=HDA will be enabled if present, disabled otherwise.

3.2.4 Security

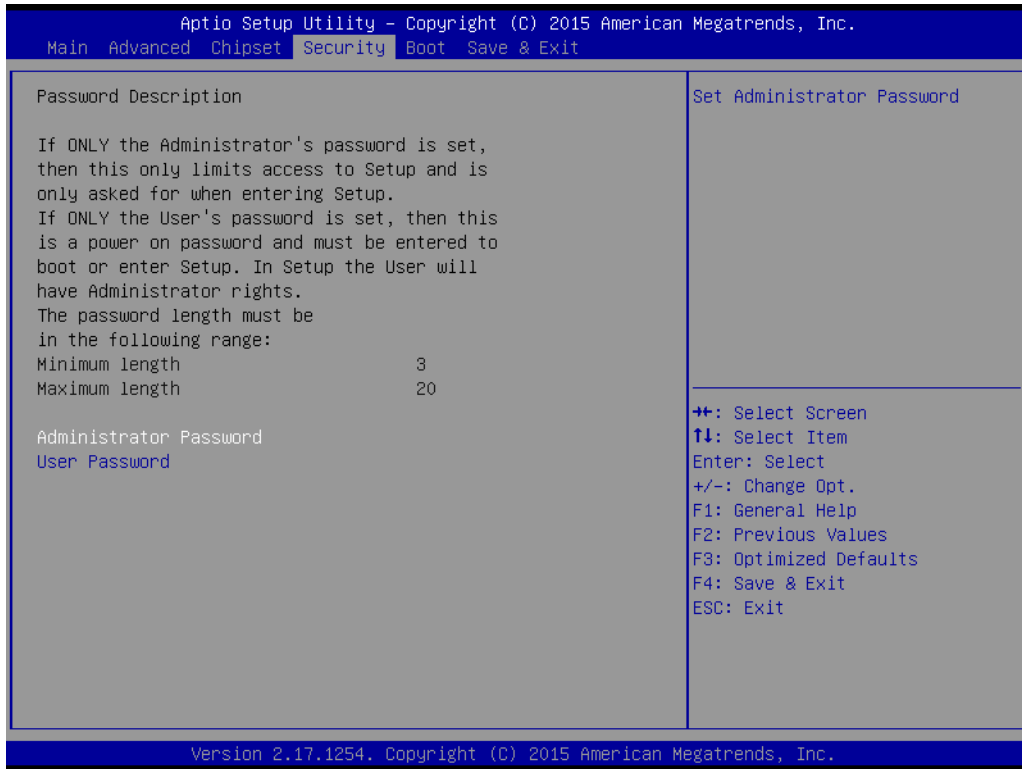

Figure 3.30 Security

Select Security Setup from the PCE-7129/5129/5029 setup main BIOS setup menu. All Security Setup options, such as password protection and virus protection are described in this section. To access the sub menu for the following items, select the item and press <Enter>.

3.2.5 Boot

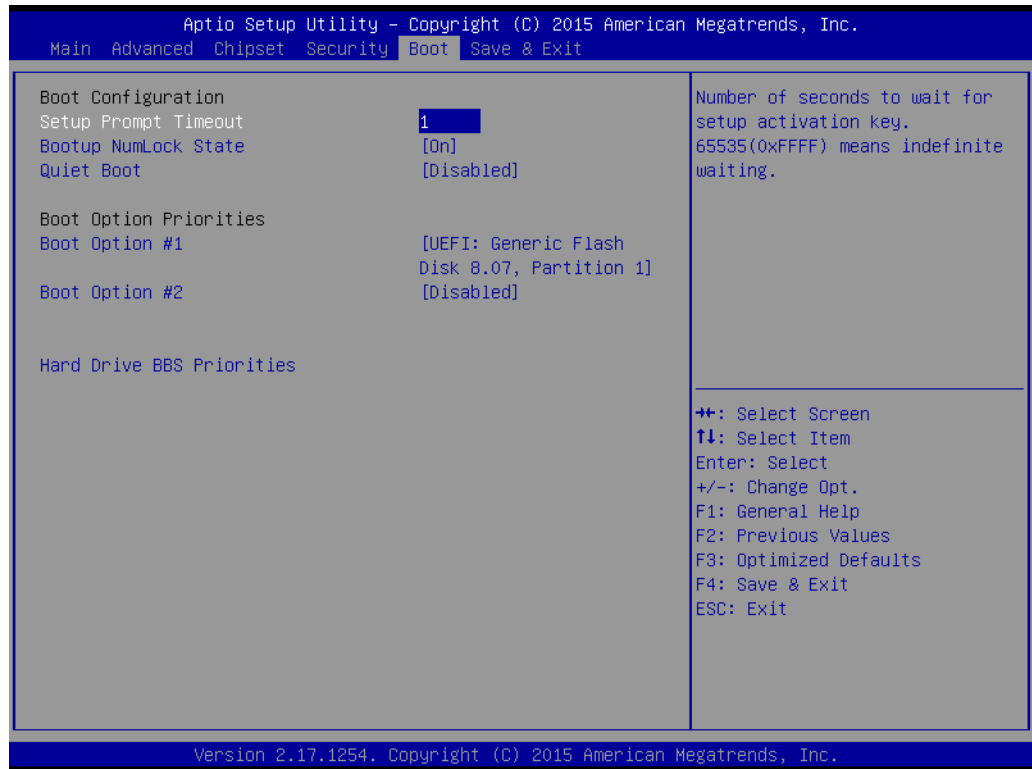

Figure 3.31 Boot

- **Setup Prompt timeout**
Number of seconds to wait for setup activation key.
- **Bootup NumLock State**
Select the keyboard Numlock state.
- **Quiet Boot**
Enable/Disable Quiet Boot option.
- **Boot Option Priorities**
Displays information about boot priority options of devices.
- **Hard Drive BBS Priorities**
Set the order of the legacy devices in this group.

3.2.6 Save & Exit

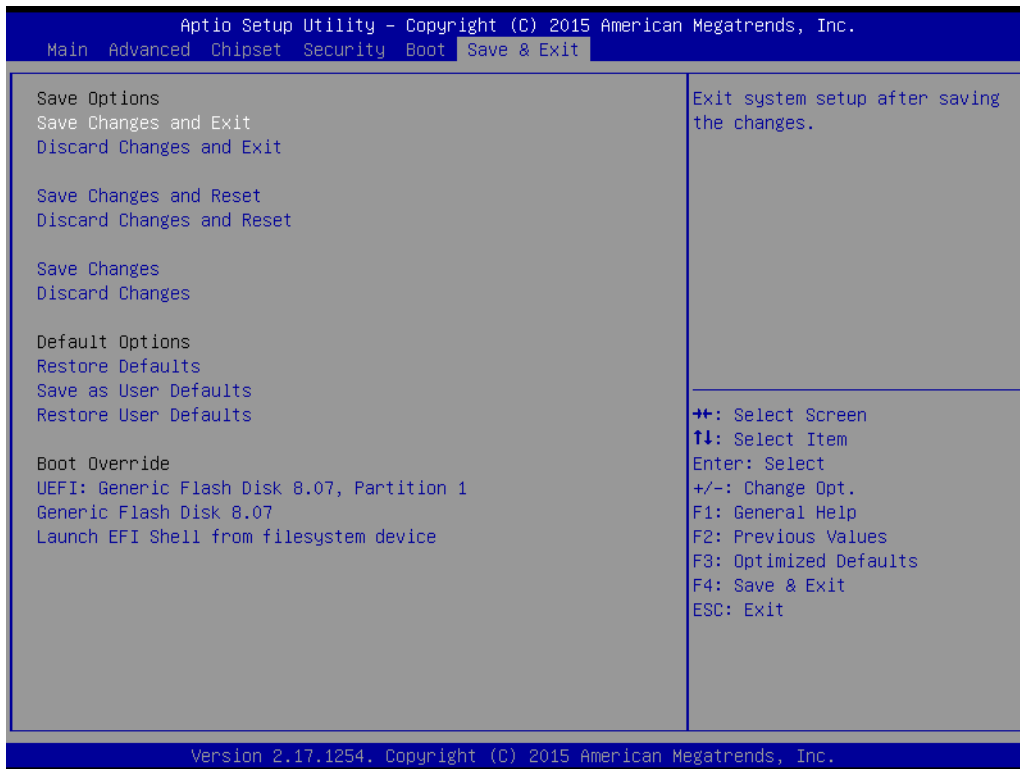

Figure 3.32 Save & Exit

- **Save changes and exit***
When you have completed system configuration, select this option to save your changes.
- **Discard changes and exit**
Select this option to quit Setup without making any permanent changes to the system configuration.
- **Save changes and Reset**
When you have completed system configuration, select this option to save your changes, exit BIOS setup and reboot into the computer so the new system configuration parameters can take effect.
- **Discard changes and Reset**
Select this option to quit setup and reset computer without making any permanent changes to the system configuration.
- **Save Changes**
Select this option to save your changes.
- **Discard Changes**
Select this option to discard your changes.
- **Restore Defaults**
Select this option to restore BIOS configuration as origin.
- **Save as User Defaults**
Select this option to save user's configuration.
- **Restore User Defaults**
Select this option to restore BIOS to user's configuration.

*When you make some critical changes, the system will still reboot even if you chose "Save changes and exit".

Chapter 4

Value-Added Software Services

4.1 Value-Added Software Services

Software API are interface that define the ways in which an application program may request services from libraries and/or operating systems. They provide not only the underlying drivers required but also a rich set of user-friendly, intelligent and integrated interfaces, which speed development, enhance security and offer add-on value for Advantech platforms. API plays the role of catalyst between developer and solution, and make Advantech embedded platforms easier and simpler to adopt and operate with customer applications. This API and utility is only for Microsoft Windows desktop OS, so if users needs Linux version API and utility, then contact an Advantech representative for support.

4.1.1 Software API

4.1.1.1 Control

GPIO



General Purpose Input/Output is a flexible parallel interface that allows a variety of custom connections. allows users to monitor the level of signal input or set the output status to switch on/off the device. Our API also provides Programmable GPIO, which allows developers to dynamically set the GPIO input or output status.

4.1.1.2 Monitor

Watchdog



A watchdog timer (WDT) is a device that performs a specific operation after a certain period of time if something goes wrong and the system does not recover on its own. A watchdog timer can be programmed to perform a warm boot (restarting the system) after a certain number of seconds.

Hardware Monitor



The Hardware Monitor (HWM) API is a system health supervision API that inspects certain condition indexes, such as fan speed, temperature and voltage.

4.1.2 Software Utility

Monitoring



The Monitoring utility allows the customer to monitor system health, including voltage, CPU and system temperature and fan speed. These items are important to a device; if critical errors happen and are not solved immediately, permanent damage may be caused.

Chapter 5

Chipset Software
Installation Utility

5.1 Before You Begin

To facilitate the installation of the enhanced display drivers and utility software, read the instructions in this chapter carefully. The drivers for the PCE-7129/5129/5029 are located on the software installation CD. The driver in the folder of the driver CD will guide and link you to the utilities and drivers for Windows. Updates are provided via Service Packs from Microsoft®.

Note! *The files on the software installation CD are compressed. Do not attempt to install the drivers by copying the files manually. You must use the supplied SETUP program to install the drivers.*



Before you begin, it is important to note that most display drivers need to have the relevant software application already installed in the system prior to installing the enhanced display drivers. In addition, many of the installation procedures assume that you are familiar with both the relevant software applications and operating system commands. Review the relevant operating system commands and the pertinent sections of your application software's user manual before performing the installation.

5.2 Introduction

The Intel® Chipset Software Installation (CSI) utility installs the Windows INF files that outline to the operating system how the chipset components will be configured. This is needed for the proper functioning of the following features:

- Core PCI PnP services
- Serial ATA interface support
- USB 1.1/2.0/3.0 support
- Identification of Intel® chipset components in the Device Manager
- Integrates superior video features. These include filtered sealing of 720 pixel DVD content, and MPEG-2 motion compensation for software DVD

Note! *Wrong driver installation may cause unexpected system instability.*



5.3 Windows 7/8.1/10 8 Driver Setup

1. Insert the driver CD into your system's CD-ROM drive. You can see the driver folder items. Navigate to the "00_Chipset" folder and click "infinst_autol.exe" to complete the installation of the driver.

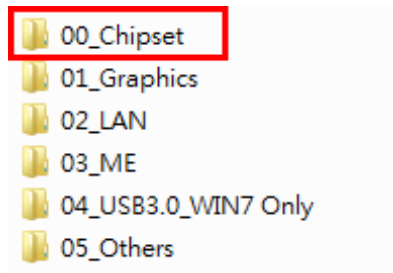

Chapter 6

Integrated Graphic
Device Setup

6.1 Introduction

Intel 6th generation Intel CPUs have integrated graphics controllers. You need to install the VGA driver to enable this function, which includes the following features:

- **Optimized integrated graphic solution:** Intel Graphics Flexible Display Interface supports versatile display options and 3D graphics engine. Triple independent display, enhanced display modes for widescreen flat panels for extended, twin, and clone dual display modes, and optimized 3D support delivers an intensive and realistic visual experience.

6.2 Windows 7/8.1/10 Driver Setup

Note! *Before installing this driver, make sure the INF driver has been installed in your system. See Chapter 5 for information on installing the INF driver.*



Insert the driver CD into your system's CD-ROM drive. You can see the driver folder items. Navigate to correct the "01_Graphics" folder and choose correct operation system type, then click "setup.exe" to complete the installation of the driver.

Note! *Intel only support x86 graphics driver for Windows 7, not for Server 2008/2012, Windows 8.1 and Windows 10.*



Chapter 7

LAN Configuration

7.1 Introduction

PCE-7129/5129/5029 has dual/single Gigabit Ethernet LANs with dedicated PCI Express x1 lanes. Intel I219LM/I219V(LAN1) and I211AT/I210AT(LAN2) that offer bandwidth of up to 500 MB/sec, eliminating the bottleneck of network data flow and incorporating Gigabit Ethernet at 1000 Mbps.

7.2 Installation

Note! *Before installing the LAN drivers, make sure the CSI utility has been installed on your system. See Chapter 5 for information on installing the CSI utility.*



Intel I219LM/I219V(LAN1) and I211AT/I210AT (LAN2) Gigabit integrated controllers support all major network operating systems. However, the installation procedure varies from system to system. Please find and use the section that provides the driver setup procedure for the operating system you are using.

7.3 Windows 7/8.1/10 Driver Setup (LAN)

Insert the driver CD into your system's CD-ROM drive. Navigate to the "02_LAN" folder and click "Autorun.exe" to complete the installation of the driver.

Note! *Wrong driver installation may cause unexpected system instability.*

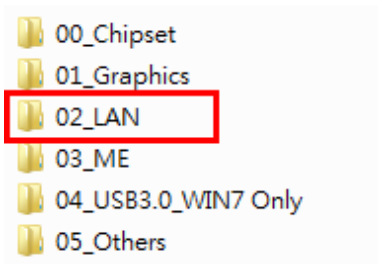

Chapter 8

Intel ME

8.1 Introduction

The Intel® ME software components that need to be installed depend on the system's specific hardware and firmware features. The installer detects the system's capabilities and installs the relevant drivers and applications.

8.2 Installation

Before install ME driver under Windows 7/server 2008 R2, please upgrade Kernel-Mode Driver Framework version 1.11 update first and you can find the file in the folder of Window 7 update and please reboot your device. After bootup, navigate to the 03_ME folder and click MEISetup.exe to complete the installation of ME driver.

Note! *If the Intel® Management Engine (Intel® ME) driver has not been successfully installed, you may see an error on a "PCI Simple Communications Controller" in Device Manager.*

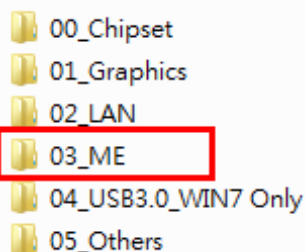

Chapter 9

Intel USB 3.0

9.1 Introduction

PCE-7129/5129/5029 provides Intel® USB 3.0 and the data transfer rates of USB 3.0 (5 Gbps) which is 10 times faster than USB 2.0 (480Mbps).

9.2 Installation

Insert the driver CD into your system's CD-ROM drive. Navigate to the "04_USB3.0" folder and click "setup.exe" to complete the installation of the driver.

Note!



- *Since Intel® 6th generation PCH only features USB 3.0 Host Controller and Microsoft Windows 7 excludes USB3.0 in box driver, USB device might not work properly while installing Windows 7. Please use SATA device to install Windows 7 and USB3.0 driver.*
- *Advantech embedded WES7 image preload USB3.0 driver.*
- *Since Windows 8.1 and 10 have in box USB3.0 driver, USB3.0 host controller can be activated while installing OS.*
- *Intel only supports USB3.0 driver for Windows 7.*

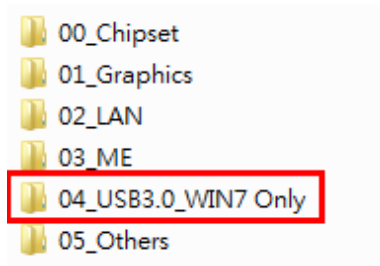

Chapter 10

SATA RAID Setup

10.1 Introduction

To support demanding disk I/O, Q170/C236 chipset integrates six Serial ATA controllers with software RAID 0, 1, 5, 10 capabilities.

RAID 0 striping increases the storage performance and is designed to speed up data transfer rates for disk-intensive applications.

RAID 1 mirroring protects valuable data that might be lost in the event of a hard drive failure.

RAID 5 array contains three or more hard drives where the data is divided into manageable blocks called strips. Parity is a mathematical method for recreating data that was lost from a single drive, which increases fault-tolerance. The data and parity are striped across all the hard drives in the array. The parity is striped in a rotating sequence to reduce bottlenecks associated with the parity calculations.

RAID 10 array uses four hard drives to create a combination of RAID levels 0 and 1. The data is striped across a two-drive array forming the RAID 0 component. Each of the drives in the RAID 0 array is then mirrored by a RAID 1 component.

10.2 SATA RAID Driver and Utility Setup

The driver is in the CD's "05_Others/Raid" folder. Go to the directory and follow Intel's installation guide to install the driver and utility.

Note!



For the detailed installation instructions for the SATA RAID driver and utility, please check the User Guide in the driver CD. Path: "05_Others/Raid".

Note!



*Before you install the Intel Rapid Storage Technology, please read the "readme.txt" which is in the folder "05_Others/Raid".
PCE-5029 (H110) don't support SATA Raid mode.*

Appendix **A**

Programming the Watchdog Timer

A.1 Introduction

The PCE-7129/5129/5029's watchdog timer can be used to monitor system software operation and take corrective action if the software fails to function within the programmed period. This section describes the operation of the watchdog timer and how to program it.

A.1.1 Watchdog timer overview

The watchdog timer is built in to the NCT6776D super I/O controller. It provides the following user programmable functions:

- Can be enabled and disabled via user's program
- Timer can be set from 1 to 255 seconds or 1 to 255 minutes
- Generates a reset signal if the software fails to reset the timer before time-out

A.1.2 Programming the watchdog timer

The I/O port address of the watchdog timer is 2E (hex) and 2F (hex). 2E (hex) is the address port. 2F (hex) is the data port. You must first write an address value into address port 2E (hex), then write/read data to/from the assigned register through data port 2F (hex).

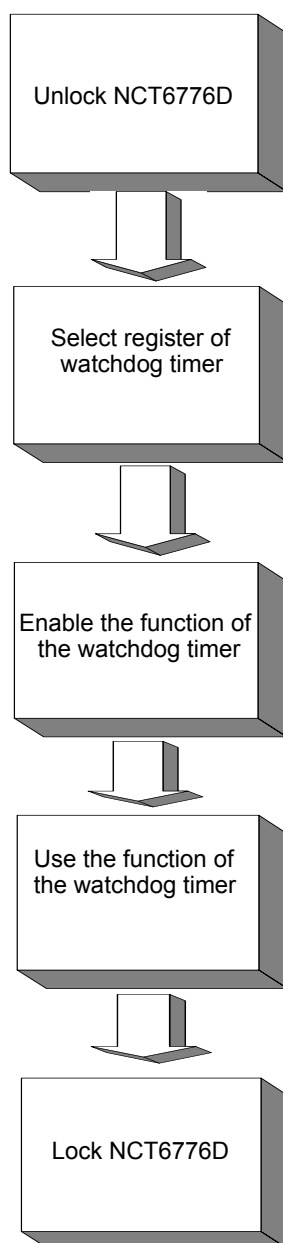
Table A.1: Watchdog timer registers

Address of register (2E)	Attribute Read/Write	Value (2F) & description
87 (hex)	----	Write this address to I/O address port 2E (hex) twice to unlock the NCT6776D
07 (hex)	write	Write 08 (hex) to select register of watchdog timer.
30 (hex)	write	Write 01 (hex) to enable the function of the watchdog timer. Disabled is set as default.
F5 (hex)	write	Set seconds or minutes as units for the timer. Write 0 to bit 3: set second as counting unit. [default]. Write 1 to bit 3: set minutes as counting unit Write 1 to bit 4: Watchdog timer count mode is 1000 times faster. If bit 3 is 0, the count mode is 1/1000 seconds mode. If bit 3 is 1, the count mode is 1/1000 minutes mode.

F6 (hex)	write	0: stop timer [default] 01~FF (hex): The amount of the count, in seconds or minutes, depends on the value set in register F5 (hex). This number decides how long the watchdog timer waits for strobe before generating an interrupt or reset signal. Writing a new value to this register can reset the timer to count with the new value.
F7 (hex)	read/write	Bit 6: Write 1 to enable keyboard to reset the timer, 0 to disable.[default] Bit 5: Write 1 to generate a timeout signal immediately and automatically return to 0. [default=0] Bit 4: Read status of watchdog timer, 1 means timer is "timeout".
AA (hex)	----	Write this address to I/O port 2E (hex) to lock the NCT6776D.

A.1.3 Example program

1. Enable watchdog timer and set 10 sec. as timeout interval

```

;-----
Mov dx,2eh          ; Unlock NCT6776D
Mov al,87h
Out dx,al
Out dx,al
;-----
Mov al,07h          ; Select registers of watchdog timer
Out dx,al
Inc dx
Mov al,08h
Out dx,al
;-----
DEC DX
MOV AL,2DH
OUT DX,AL
INC DX
MOV AL,00H
OUT DX,AL
;-----
Dec dx              ; Enable the function of watchdog timer
Mov al,30h
Out dx,al
Inc dx
In al,dx
Or al,01h
Out dx,al
;-----
Dec dx              ; Set second as counting unit
Mov al,0f5h
Out dx,al

```

```

Inc    dx
In     al,dx
And al,not 08h
Out    dx,al
;-----
Dec dx          ; Set timeout interval as 10 seconds and start counting
Mov    al,0f6h
Out    dx,al
Inc    dx
Mov    al,10    ; 10 seconds
Out    dx,al
;-----
Dec dx          ; Lock NCT6776D
Mov    al,0aah
Out    dx,al

```

2. Enable watchdog timer and set 5 minutes as timeout interval

```

;-----
Mov dx,2eh          ; Unlock NCT6776D
Mov al,87h
Out dx,al
Out dx,al
;-----
Mov al,07h          ; Select registers of watchdog timer
Out  dx,al
Inc  dx
In   al,dx
Or   al,08h
Out  dx,al
;-----
DEC DX
MOV  AL,2DH
OUT  DX,AL
INC  DX
MOV  AL,00H
OUT  DX,AL
;-----
DEC DX
MOV  AL,2DH
OUT  DX,AL
INC  DX
MOV  AL,00H
OUT  DX,AL
;-----
DEC DX

```

```

MOV    AL,2DH
OUT    DX,AL
INC    DX
MOV    AL,00H
OUT    DX,AL
;-----
Dec dx          ; Enable the function of watchdog timer
Mov    al,30h
Out    dx,al
Inc    dx
Mov    al,01h
Out    dx,al
;-----
Dec dx          ; Set minute as counting unit
Mov    al,0f5h
Out    dx,al
Inc    dx
In     al,dx
Or     al,08h
Out    dx,al
;-----
Dec dx          ; Set timeout interval as 5 minutes and start counting
Mov    al,0f6h
Out    dx,al
Inc    dx
Mov    al,5      ; 5 minutes
Out    dx,al
;-----
Dec dx          ; Lock NCT6776D
Mov    al,0aah
Out    dx,al

3.   Enable watchdog timer to be reset by mouse
;-----
Mov dx,2eh      ; Unlock NCT6776D
Mov al,87h
Out dx,al
Out dx,al
;-----
Mov al,07h      ; Select registers of watchdog timer
Out    dx,al
Inc    dx
Mov    al,08h
Out    dx,al
;-----

```

```

Dec dx          ; Enable the function of watchdog timer
Mov  al,30h
Out  dx,al
Inc  dx
In   al,dx
Or   al,01h
Out  dx,al

```

```

;-----
Dec dx          ; Enable watchdog timer to be reset by mouse
Mov  al,0f7h
Out  dx,al
Inc  dx
In   al,dx
Or   al,80h
Out  dx,al

```

```

;-----
Dec dx          ; Lock NCT6776D
Mov  al,0aah
Out  dx,al

```

4. Enable watchdog timer to be reset by keyboard

```

;-----
Mov dx,2eh      ; Unlock NCT6776D
Mov al,87h
Out dx,al
Out dx,al
;-----
Mov al,07h      ; Select registers of watchdog timer
Out  dx,al
Inc  dx
Mov  al,08h
Out  dx,al

```

```

;-----
Dec dx          ; Enable the function of watchdog timer
Mov  al,30h
Out  dx,al
Inc  dx
Mov  al,01h
Out  dx,al
;-----
Dec dx          ; Enables watchdog timer to be strobe reset by keyboard
Mov  al,0f7h
Out  dx,al
Inc  dx
In   al,dx

```

```

Or al,40h
Out dx,al
;-----
Dec dx ; Lock NCT6776D
Mov al,0aah
Out dx,al

5. Generate a time-out signal without timer counting
;-----
Mov dx,2eh ; Unlock NCT6776D
Mov al,87h
Out dx,al
Out dx,al
;-----
Mov al,07h ; Select registers of watchdog timer
Out dx,al
Inc dx
Mov al,08h
Out dx,al
;-----
Dec dx ; Enable the function of watchdog timer
Mov al,30h
Out dx,al
Inc dx
Mov al,01h
Out dx,al
;-----
Dec dx ; Generate a time-out signal
Mov al,0f7h
Out dx,al ;Write 1 to bit 5 of F7 register
Inc dx
In al,dx
Or al,20h
Out dx,al
;-----
Dec dx ; Lock NCT6776D
Mov al,0aah
Out dx,al

```

Appendix **B**

I/O Pin Assignments

B.1 Parallel Port Connector (LPT1)

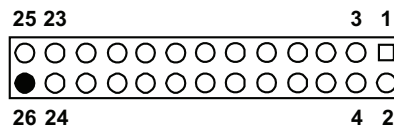

Table B.1: Parallel port connector (LPT1)

Pin	Signal	Pin	Signal
1	STROBE*	2	AUTOFD*
3	D0	4	ERR
5	D1	6	INIT*
7	D2	8	SLCTINI*
9	D3	10	GND
11	D4	12	GND
13	D5	14	GND
15	D6	16	GND
17	D7	18	GND
19	ACK*	20	GND
21	BUSY	22	GND
23	PE	24	GND
25	SLCT	26	N/C

* low active

B.2 VGA Connector (VGA1)

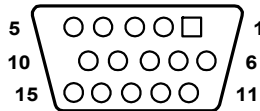

Table B.2: VGA connector (VGA1)

Pin	Signal	Pin	Signal
1	RED	9	VCC
2	GREEN	10	GND
3	BLUE	11	N/C
4	N/C	12	SDT
5	GND	13	H-SYNC
6	GND	14	V-SYNC
7	GND	15	SCK
8	GND		

B.3 RS 232 Serial Port (COM12)

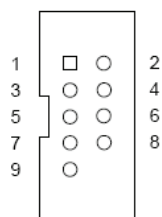

Table B.3: RS-232 serial port (COM2)

Pin	Signal
1	DCD
2	DSR
3	SIN
4	RTS
5	SOUT
6	CTS
7	DTR
8	RI
9	GND

B.4 USB 2.0 Header (USB56 & 910)

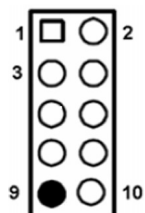

Table B.4: USB Header (USB56 & 910)

Pin	Signal	Pin	Signal
1	USB1_VCC5	6	USB2_D+
2	USB2_VCC5	7	GND
3	USB1_D-	8	GND
4	USB2_D-	9	Key
5	USB1_D+	10	NC

B.5 USB3.0 Header (USB12)

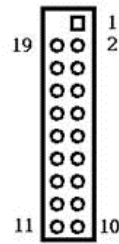

Table B.5: USB 3.0 Header (USB12)

Pin	Signal	Pin	Signal
1	USB1_VCC5	11	USB_P+_P2
2	USB3.0_RXN_P1	12	USB_P-_P2
3	USB3.0_RXP_P1	13	GND
4	GND	14	USB3.0_TXP_P2
5	USB3.0_TXN_P1	15	USB3.0_TXN_P2
6	USB3.0_TXP_P1	16	GND
7	GND	17	USB3.0_RXP_P2
8	USB_P-_P1	18	USB3.0_RXN_P2
9	USB_P+_P1	19	USB2_VCC5
10	Reserve		

B.6 PS/2 Keyboard/Mouse Connector (KBMS1)

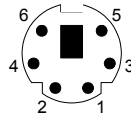

Table B.6: PS/2 keyboard/mouse connector (KBMS1)

Pin	Signal
1	KB DATA
2	MS DATA
3	GND
4	VCC
5	KB CLOCK
6	MS CLOCK

B.7 External Keyboard Connector (KBMS2)

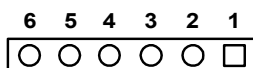

Table B.7: External keyboard connector (KBMS2)

Pin	Signal
1	KBCLK
2	KBDAT
3	MSDAT
4	GND
5	MSVCC
6	MSCLK

B.8 CPU and System Fan Power Connector (CPUFAN1 /SYSFAN1)

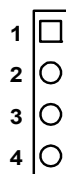

Table B.8: CPU and system fan power connector (CPUFAN1)

Pin	Signal
1	GND
2	+12V
3	Detect
4	FAN1_PWMOUT

B.9 Power LED and Keyboard Lock Connector (JFP3 / PWR_LED & KEY LOCK)

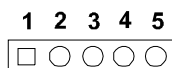

Table B.9: Power LED and keyboard lock connector (JFP3 / PWR_LED & KEY LOCK)

Pin	Signal
1	LED power (+3.3 V)
2	NC
3	GND
4	KEYLOCK#
5	GND

B.10 External Speaker Connector (JFP2 / SPEAKER)

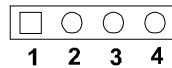

Table B.10: External speaker connector (JFP2 / SPEAKER)

Pin	Signal
1	SPK_CN17P1
2	SPK_CN17P2
3	SPK_CN17P3
4	SPK_CN17P4

B.11 Reset Connector (JFP1 / RESET)

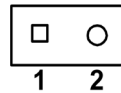

Table B.11: Reset connector (JFP1 / RESET)

Pin	Signal
1	RESET #
2	GND

B.12 HDD LED (JFP2 / HDDLED)

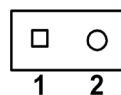

Table B.12: HDD LED (JFP2 / HDDLED)

Pin	Signal
1	HDD LED
2	SATA LED

B.13 ATX Soft Power Switch (JFP1 / PWR_SW)

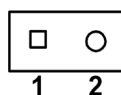

Table B.13: ATX soft power switch (JFP1 / PWR_SW)

Pin	Signal
1	3.3 VSB
2	PWR-BTN

B.14 Hi-definition Audio Link Connector (HDAUD1)

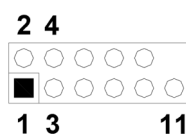

Table B.14: Hi-definition audio link connector (HDAUD1)

Pin	Signal	Pin	Signal
1	ACZ_VCC	2	GND
3	ACZ_SYNC	4	ACZ_BITCLK
5	ACZ_SDOOUT	6	ACZ_SDIN0
7	ACZ_SDIN1	8	-ACZ_RST
9	ACZ_12V	10	GND
11	GND	12	N/C

B.15 SM Bus Connector (JFP2 / SNMP)

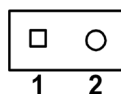

Table B.15: SM bus connector (JFP2 / SNMP)

Pin	Signal
1	SMB_DATA
2	SMB_CLK

B.16 LAN1 and LAN2 LED Connector (LANLED1)

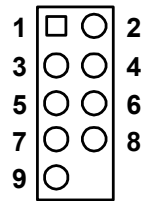

Table B.16: LAN1 and LAN2 LED connector (LANLED1)

Pin	Signal
1	#LAN1_ACT
2	#LAN2_ACT
3	V33_AUX
4	V33_AUX
5	#LAN1_LINK1000
6	#LAN2_LINK1000
7	#LAN1_LINK100
8	#LAN2_LINK100
9	V33_AUX

B.17 GPIO Header (GPIO1)

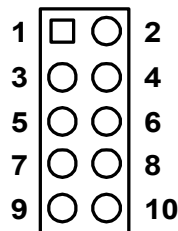

Table B.17: GPIO header (GPIO1)

Pin	Signal
1	SIO_GPIO0
2	SIO_GPIO4
3	SIO_GPIO1
4	SIO_GPIO5
5	SIO_GPIO2
6	SIO_GPIO6
7	SIO_GPIO3
8	SIO_GPIO7
9	+5V_Dual_GPIO
10	GND

B.18 Fixed I/O Ranges Decoded by Intel PCH

Table B.18: Fixed I/O Ranges Decoded by PCH			
I/O Address	Read Target	Write Target	Internal Unit
20h - 21h	Interrupt Controller	Interrupt Controller	Interrupt
24h - 25h	Interrupt Controller	Interrupt Controller	Interrupt
28h - 29h	Interrupt Controller	Interrupt Controller	Interrupt
2Ch - 2Dh	Interrupt Controller	Interrupt Controller	Interrupt
2Eh - 2Fh	LPC/eSPI	LPC/eSPI	Forwarded to LPC/eSPI
30h - 31h	Interrupt Controller	Interrupt Controller	Interrupt
34h - 35h	Interrupt Controller	Interrupt Controller	Interrupt
38h - 39h	Interrupt Controller	Interrupt Controller	Interrupt
3Ch - 3Dh	Interrupt Controller	Interrupt Controller	Interrupt
40h	Timer/Counter	Timer/Counter	8254 Timer
42h - 43h	Timer/Counter	Timer/Counter	8254 Timer
4Eh - 4Fh	LPC/eSPI	LPC/eSPI	Forwarded to LPC/eSPI
50h	Timer/Counter	Timer/Counter	8254 Timer
52h - 53h	Timer/Counter	Timer/Counter	8254 Timer
60h	LPC/eSPI	LPC/eSPI	Forwarded to LPC/eSPI
61h	NMI Controller	NMI Controller	Processor I/F
62h	Microcontroller	Microcontroller	Forwarded to LPC/eSPI
63h	NMI Controller	NMI Controller	Processor I/F
64h	Microcontroller	Microcontroller	Forwarded to LPC/eSPI
65h	NMI Controller	NMI Controller	Processor I/F
66h	Microcontroller	Microcontroller	Forwarded to LPC/eSPI
67h	NMI Controller	NMI Controller	Processor I/F
70h	RTC Controller	NMI and RTC Controller	RTC
71h	RTC Controller	RTC Controller	RTC
72h	RTC Controller	RTC Controller	RTC
73h	RTC Controller	RTC Controller	RTC
74h	RTC Controller	RTC Controller	RTC
75h	RTC Controller	RTC Controller	RTC
76h - 77h	RTC Controller	RTC Controller	RTC
80h	LPC/eSPI or PCIe	LPC/eSPI or PCIe	LPC/eSPI or PCIe
84h - 86h	Reserved	LPC/eSPI or PCIe	LPC/eSPI or PCIe
88h	Reserved	LPC/eSPI or PCIe	LPC/eSPI or PCIe
8Ch - 8Eh	Reserved	LPC/eSPI or PCIe	LPC/eSPI or PCIe
90h	(Alias to 80h)	(Alias to 80h)	Forwarded to LPC/eSPI
92h	Reset Generator	Reset Generator	Processor I/F
94h - 96h	(Alias to 80h)	(Alias to 80h)	Forwarded to LPC/eSPI
98h	(Alias to 80h)	(Alias to 80h)	Forwarded to LPC/eSPI
9Ch - 9Eh	(Alias to 80h)	(Alias to 80h)	Forwarded to LPC/eSPI
A0h - A1h	Interrupt Controller	Interrupt Controller	Interrupt
A4h - A5h	Interrupt Controller	Interrupt Controller	Interrupt
A8h - A9h	Interrupt Controller	Interrupt Controller	Interrupt
ACh - Adh	Interrupt Controller	Interrupt Controller	Interrupt
B0h - B1h	Interrupt Controller	Interrupt Controller	Interrupt

B2h - B3h	Power Management	Power Management	Power Management
B4h - B5h	Interrupt Controller	Interrupt Controller	Interrupt
B8h - B9h	Interrupt Controller	Interrupt Controller	Interrupt
BCh - BDh	Interrupt Controller	Interrupt Controller	Interrupt
200 - 207h	Gameport Low	Gameport Low	Forwarded to LPC/eSPI
208-20Fh	Gameport Low	Gameport Low	Forwarded to LPC/eSPI
4D0h -4D1h	Interrupt Controller	Interrupt Controller	Interrupt Controller
CF9h	Reset Generator	Reset Generator	Interrupt controller

Note! Only if the Port 61 Alias Enable bit (GCS.P61AE) bit is set. Otherwise, the target is PCI.



B.19 System I/O Ports

Table B.19: System I/O Ports

I/O Address (Hex)	Device
090h-097h	SATA AHCI controller
070h-077h	System CMOS/real time clock
2F8h-2FFh	Communication Port (COM2)
378h-37Fh	ECP Printer Port(LPT1)
3B0h-3BBh	Graphics
3C0h-3DFh	Graphics
3F8h-3FFh	Communication Port (COM1)
600h-67Fh	PCA-COM485 Module I/O used
778h-77Fh	ECP Printer Port(LPT1)
C80h-C9Fh	Communication port (COM3-6) for PCA-COM232 module
CA0h-CBFh	Communication port (COM8-11) for PCA-COM485 module

B.20 Interrupt Assignments

Table B.20: Interrupt Assignments

Interrupt#	Interrupt source
IRQ0	System timer
IRQ1	Keyboard
IRQ2	Interrupt from controller 2 (cascade)
IRQ3	Communication port (COM2)
IRQ4	Communication port (COM1)
IRQ5	Available
IRQ6	Communication port (COM8-11) for PCA-COM485 module
IRQ7	Parallel Port
IRQ8	System COMS/Real-time clock
IRQ9	Available
IRQ10	Available
IRQ11	Communication port (COM3-6) for PCA-COM232 module
IRQ12	PS/2 mouse

IRQ13	Numeric data processor
IRQ14	Available
IRQ15	Available

B.21 1 MB Memory Map

Table B.21: 1 MB memory map

Address Range	Device
E8000h - FFFFFh	BIOS
CFB00H - DFFFFh	Unused
C0000h - CBFFFh	VGA BIOS
A0000h - BFFFFh	Video Memory
00000h - 9FFFFh	Base memory

B.22 PCI Bus Map

Table B.22: PCI Bus Map

Signal	IDSEL	INT#PIN	GNT	REQ
PCI Slot 1	AD31	INT B, C, D, A	GNT A	REQ A
PCI Slot 2	AD30	INT C, D, A, B	GNT B	REQ B
PCI Slot 3	AD29	INT D, A, B, C	GNT C	REQ C
PCI Slot 4	AD28	INT A, B, C, D	GNT D	REQ D

Appendix **C**

Programming the
GPIO

C.1 Supported GPIO Register

Below are the detailed descriptions of the GPIO addresses and a programming sample.

C.2 GPIO Registers

Bank Logical Device	Offset	Description
09h	30h	Write 1 to bit 7 to enable GPIO
07h	E0h	GPIO I/O Register When set to a '1', respective GPIO port is programmed as an input port. When set to a '0', respective GPIO port is programmed as an output port.
07h	E1h	GPIO Data Register If a port is programmed to be an output port, then its respective bit can be read/written. If a port is programmed to be an input port, then its respective bit can only be read.
07h	E2h	GPIO Inversion Register When set to a '1', the incoming/outgoing port value is inverted. When set to a '0', the incoming/outgoing port value is the same as in data register.

C.3 GPIO Example Program-1

Enter the extended function mode, interruptible double-write

```
MOV DX,2EH
MOV AL,87H
OUT DX,AL
OUT DX,AL
```

Configure logical device, configuration register CRE0,CRE1,CRE2

```
MOV DX,2EH
MOV AL,09H
OUT DX,AL
DEC DX
MOV AL,30H
OUT DX,AL
INC DX
IN AL,DX
OR AL,10000000B; GPIO7 is active
DEC DX
MOV AL,07H
OUT DX,AL
```

```
INC DX
MOV AL,07H; Select logical device 7
OUT DX,AL ;
DEC DX
MOV AL,E0H
OUT DX,AL
INC DX
MOV AL,00H ; 1:Input 0:output for GPIO respective
OUT DX,AL
DEC DX
MOV AL,E2H ;
OUT DX,AL
INC DX
MOV AL,00H ;Set GPIO is normal not inverter
OUT DX,AL;
DEC DX
MOV AL,E1H
OUT DX,AL
INC DX
MOV AL,??H ; Put the output value into AL
OUT DX,AL

-----
Exit extended function mode |
-----

MOV DX,2EH
MOV AL,AAH
OUT DX,AL
```

ADVANTECH

Enabling an Intelligent Planet

www.advantech.com

Please verify specifications before quoting. This guide is intended for reference purposes only.

All product specifications are subject to change without notice.

No part of this publication may be reproduced in any form or by any means, electronic, photocopying, recording or otherwise, without prior written permission of the publisher.

All brand and product names are trademarks or registered trademarks of their respective companies.

© Advantech Co., Ltd. 2016