

 **PART No. 1490MG10**
for more information visit
www.hammfg.com
Data subject to change without notice
Isometric drawing Not to Scale

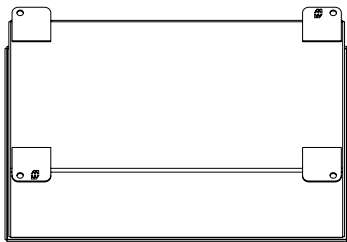

BACK VIEW

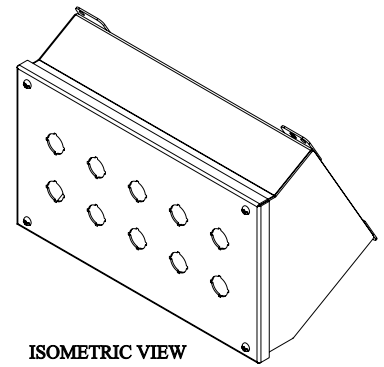
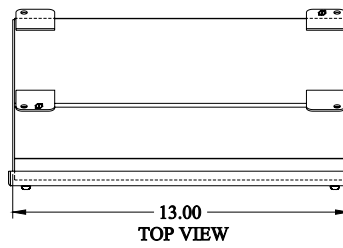
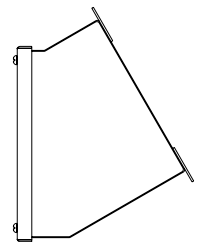
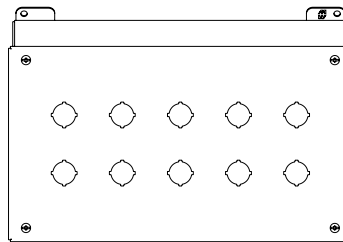
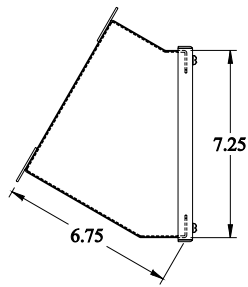

RIGHT SIDE VIEW

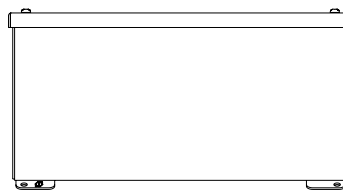

BOTTOM VIEW