

FLM DO 8 M12

Fieldline Modular Device With Eight Digital Outputs

Data Sheet 697100

02/2004



This data sheet is only valid in association with the FLS FLM SYS INST UM E user manual or the user manual for your bus system (see "Ordering Data" on page 14).

Function

The device is designed for use in the Fieldline modular local bus, which is opened by a Fieldline modular bus coupler. It is used to output digital signals.

Features

- Connection to the Fieldline modular local bus using M12 connectors (B-encoded)
- Connection of digital actuators using M12 connectors, each with a load capacity of 500 mA (nominal current)
- Flexible voltage supply concept
- LED diagnostic and status indicators
- Short-circuit and overload protection of the actuator supply
- IP65/IP67 protection

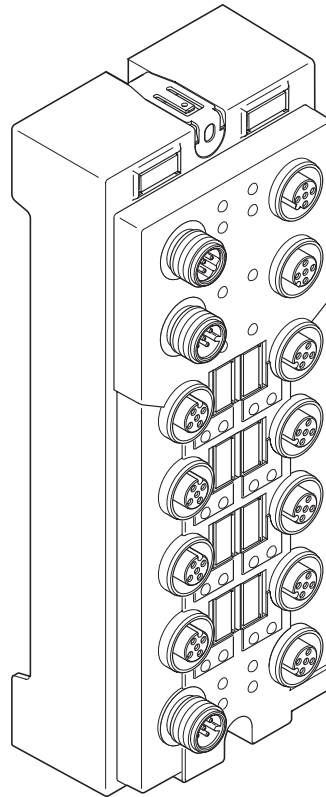

6971A001

Figure 1 The FLM DO 8 M12 Fieldline device

Connections

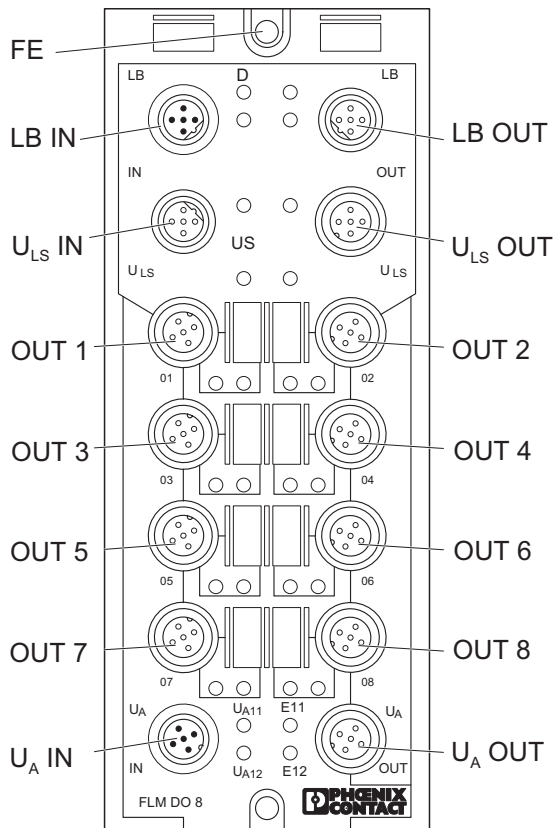

6971A002

Figure 2 Connections of the FLM DO 8 M12

Des.	Meaning
FE	Functional earth ground
LB IN	Local bus IN
LB OUT	Local bus OUT
U_{LS} IN	Voltage supply IN (logic)
U_{LS} OUT	Voltage supply OUT (logic) for additional devices
OUT1 to OUT8	Outputs 1 to 8
U_A IN	Voltage supply IN of the outputs (OUT1 to OUT8) with voltages U _{A11} and U _{A12}
U_A OUT	Voltage supply OUT of the outputs for other devices



In general, the maximum current load of 4 A per contact must not be exceeded.

Pin Assignment of LB IN/LB OUT

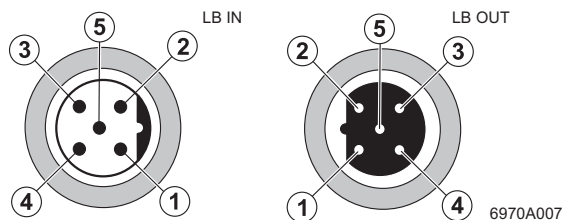

6970A007

Figure 3 Pin assignment of LB IN/ LB OUT (M12 B-encoded)

Pin	IN	OUT
1	DO	DO
2	$\overline{\text{DO}}$	$\overline{\text{DO}}$
3	DI	DI
4	$\overline{\text{DI}}$	$\overline{\text{DI}}$
5	GND	GND



The thread is used for shielding.

Pin Assignment of the Voltage Supply U_{LS}

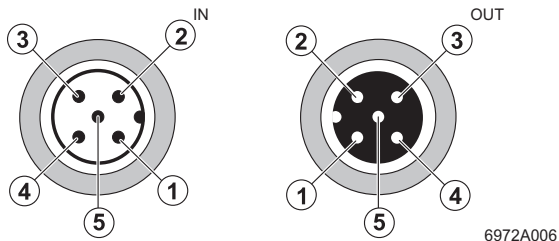

Figure 4 Pin assignment of the voltage supply U_{LS}

Pin	IN	OUT
1	$U_L +24\text{ V}$	$U_L +24\text{ V}$
2	$U_S\text{ GND}$	$U_S\text{ GND}$
3	$U_L\text{ GND}$	$U_L\text{ GND}$
4	$U_S +24\text{ V}$	$U_S +24\text{ V}$
5	500 kbaud/ 2 Mbaud	500 kbaud/ 2 Mbaud



The transmission speed is switched at the bus coupler.

Pin Assignment of the Voltage Supply U_A of the Outputs

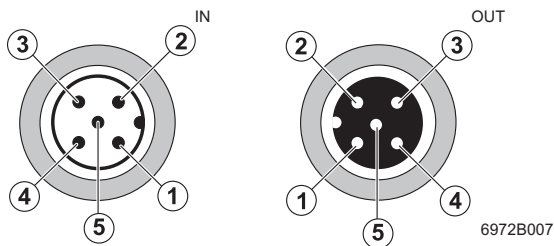

Figure 5 Pin assignment of the voltage supply U_A of the outputs

Pin	IN	OUT
1	$U_{A11} +24\text{ V}$	$U_{A11} +24\text{ V}$
2	$U_{A12}\text{ GND}$	$U_{A12}\text{ GND}$
3	$U_{A11}\text{ GND}$	$U_{A11}\text{ GND}$
4	$U_{A12} +24\text{ V}$	$U_{A12} +24\text{ V}$
5	Not used	Not used

Pin Assignment of the Outputs

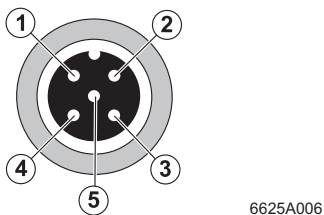
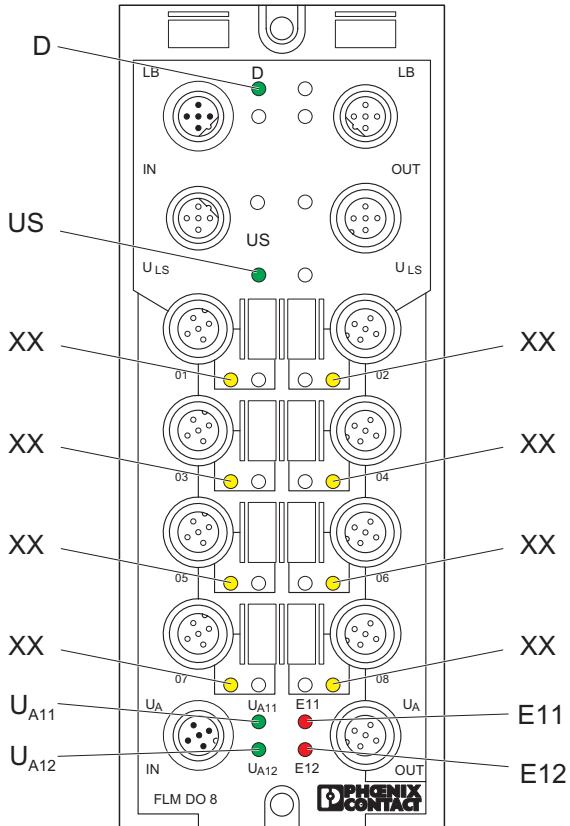

Figure 6 Pin assignment of the outputs

Pin	Output Socket
1	Not used
2	Not used
3	GND
4	Output
5	FE

Local LED Diagnostic and Status Indicators



6971A003

Figure 7 Local LED diagnostic and status indicators of the FLM DO 8 M12

Des.	Color	Meaning
D	Green LED	Diagnostics
	ON:	Bus active
	Flashing, 0.5 Hz:	Communications power present, bus not active
	Flashing, 2 Hz:	Communications power present, bus active, I/O error
	Flashing, 4 Hz:	Communications power present, transmission path to the left of the flashing device failed, device to the left of the flashing device failed, devices to the right of the flashing device are not part of the configuration frame
	OFF:	Communications power not present, bus not active
US	Green LED	Voltage supply for OUT1 to OUT8
	ON:	Voltage supply present
	OFF:	Voltage supply too low
XX	Yellow LED	Status indicators of the outputs
	ON:	Output active
	OFF:	Output not active
UA11	Green LED	Voltage supply for OUT1 to OUT4
	ON:	Voltage supply for OUT1 to OUT4 present
	OFF:	Voltage supply for OUT1 to OUT4 too low
UA12	Green LED	Voltage supply for OUT5 to OUT8
	ON:	Voltage supply for OUT5 to OUT8 present
	OFF:	Voltage supply for OUT5 to OUT8 too low
E11	Red LED	Overload of outputs OUT1 to OUT4
	ON:	Outputs OUT1 to OUT4 overloaded
	OFF:	Outputs OUT1 to OUT4 not overloaded
E11	Red LED	Overload of outputs OUT5 to OUT8
	ON:	Outputs OUT5 to OUT8 overloaded
	OFF:	Outputs OUT5 to OUT8 not overloaded

Internal Circuit Diagram

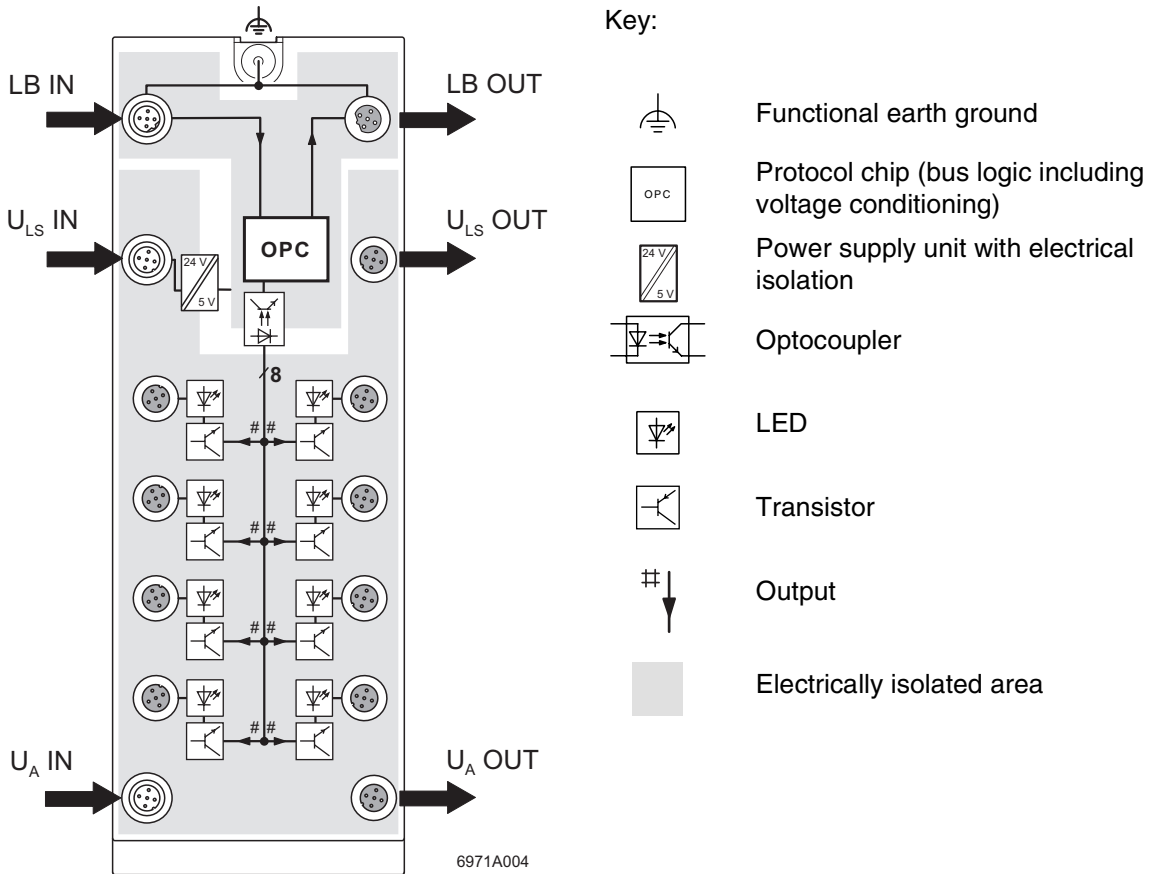
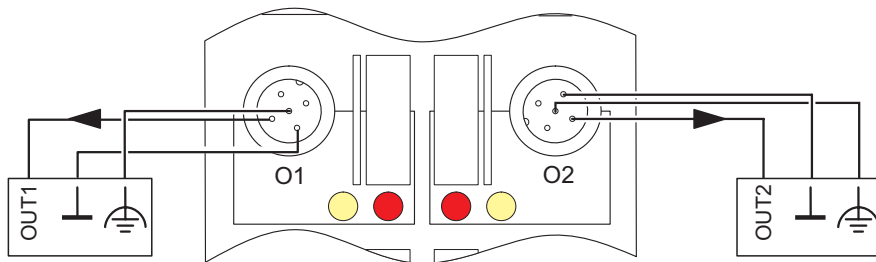

Figure 8 Internal wiring of the connection points



For information on electrically isolated areas, please refer to page 13.

Connection Example



6971A007

Figure 9 Typical connection of actuators

Connection Notes



Meet noise immunity requirements

Connect FE using a mounting screw or a cable connection to the FE connection latch (when mounting on a non-conductive surface).



Observe connection point assignment

When connecting the actuators, observe the assignment of the connection points to the OUT process data (see "Process Data" on page 8).



Ensure degree of protection

To ensure IP65/IP67 protection, cover unused sockets with protective caps.



Avoid polarity reversal

Avoid polarity reversal of the supply voltages U_S , U_A , and U_L in order to prevent damage to the device.

Programming Data/Configuration Data

INTERBUS

ID code	BD _{hex} (189 _{dec})
Length code	81 _{hex}
Process data channel	8 bits
Output address area	8 bits
Parameter channel (PCP)	0 bits
Register length (bus)	8 bits

Other Bus Systems



For the programming data of other bus systems, please refer to the appropriate electronic device data sheet (GSD, EDS). For additional information, please refer to the user manuals, see "Ordering Data" on page 14.

Process Data

Assignment of the Connection Points to the OUT Process Data

(Byte.bit) view	Byte	Byte 0							
	Bit	7	6	5	4	3	2	1	0
Device	Input	8	7	6	5	4	3	2	1





For the assignment of the illustrated (byte.bit) view for your INTERBUS control or computer system, please refer to data sheet DB GB IBS SYS ADDRESS, Part No. 90 00 99 0.

Technical Data

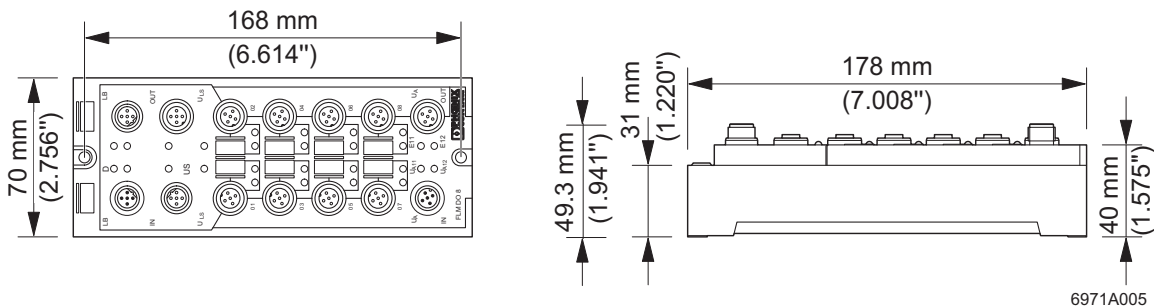
Device Dimensions



General Data	
Order designation	FLM DO 8 M12
Order no.	27 36 29 1
Housing dimensions (width x height x depth)	70 mm x 178 mm x 49.3 mm (2.756 x 7.008 x 1.941 in.)
Weight	310 g, approximately
Operating mode	Process data mode with 8 bits
Type of actuator connection	2, 3 or 4-wire technology
Permissible temperature (operation)	-25°C to +60°C (-13°F to +140°F)
Permissible temperature (storage/transport)	-25°C to +85°C (-13°F to +185°F)
Permissible humidity (storage/transport)	95%
 For a short period, slight condensation may appear on the housing.	
Permissible air pressure (operation)	80 kPa to 106 kPa (up to 2000 m [6562 ft.] above sea level)
Permissible air pressure (storage/transport)	70 kPa to 106 kPa (up to 3000 m [9843 ft.] above sea level)
Degree of protection	IP65/IP67 according to IEC 60529
Class of protection	Class 3 according to VDE 0106, IEC 60536

Mechanical Requirements	
Vibration test Sinusoidal vibrations according to EN 60068-2-6	5g load in each space direction
Shock test according to EN 60068-2-27	30g load, half sinusoidal wave positive and negative in each space direction
 For additional information on mechanical requirements and ambient conditions, please contact Phoenix Contact.	



Voltage Supply	
Nominal value	24 V DC
Tolerance	±25%
Current consumption at U_L at 24 V DC	
At 500 kbaud	40 mA, typical (50 mA, maximum)
At 2 Mbaud	45 mA, typical (50 mA, maximum)
Current consumption at U_S at 24 V DC	
	5 mA, typical, + actuator current (600 mA, maximum)

Digital Outputs	
Number	8
Nominal output voltage U_{OUT}	$U_{Axx} - 1 V$
Differential voltage for I_{nom}	≤ 1 V
Nominal current I_{nom} per channel	500 mA
Total current	4 A (observe derating)
Protection	Short circuit; overload

 Single chip structure, i.e., all channels are thermally isolated. An error in one channel can affect the other channels. The outputs have separate overload protection.

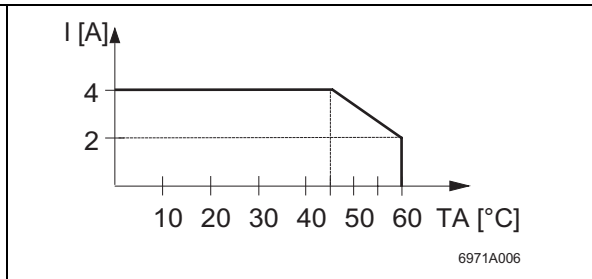
Derating at 100% simultaneity



Digital Outputs (Continued)	
	At an ambient temperature of 45°C (113°F) or higher, voltages U_L and U_S at socket U_{LS} OUT can each only carry a maximum current of 2 A. Voltages U_{A11} and U_{A12} at socket OUT can each only carry a maximum current of 2 A.
Nominal load per channel	
– Ohmic	12 W
– Inductive	12 VA (1.2 H, 48 Ω)
– Lamp	12 W
Signal delay upon power up	Approximately 50 μ s, typical
Signal delay upon power down	Approximately 70 μ s, typical
	The behavior of the output voltage depends on the switched load.
Switching frequency with	
– Nominal ohmic load	300 Hz, maximum
	This switching frequency is limited by the number of bus devices, the bus structure, the software, and the control or computer system used.
– Nominal inductive load	0.5 Hz (1.2 H, 48 Ω), maximum
– Nominal lamp load	300 Hz, maximum
Overload response	Auto restart
Restart frequency with ohmic overload (2 Ω)	45 Hz, approximately
Response with inductive overload	Output may be damaged
Reverse voltage protection against short pulses	Protected against reverse voltages
Resistance to permanently applied reverse voltages	Up to 2 A
Response upon power down	The output follows the supply voltage without delay.
Validity of output data after connecting the voltage supply (power up)	5 ms, typical
Limitation of the voltage induced on circuit interruption	-15 V, approximately
Single maximum energy in free running	1500 W

Digital Outputs (Continued)	
Protective circuit type	Integrated free-wheeling diode for each channel
Overcurrent shutdown	0.7 A, minimum
Output current when switched off	20 μ A, maximum
Output current with ground connection interrupt when switched off	5 mA, maximum

Error Messages	
Overload of outputs	Yes
 If an error is triggered at the outputs due to an overload, the device switches off the corresponding output and sends an I/O error message to the master.	
Permissible cable length to the actuator	< 30 m (98.43 ft.)

Output Characteristic Curve When Switched On (Typical)	
Output Current (A)	Differential Output Voltage (V)
0	0
0.1	0.04
0.2	0.08
0.3	0.12
0.4	0.16
0.5	0.20

Output Characteristic Curve for Ground Connection Interrupt ($U_{Axx} = 30$ V DC)	
Load Resistance ($k\Omega$)	Output Voltage (V)
∞	29.9
1000	11.2
100	1.7
10	0.2
1	0

Interface	
Bus system	Fieldline modular local bus
Incoming Bus	
Coupling of shield connection	Directly to FE
Transmission speed	500 kbaud/2 Mbaud
Outgoing Bus	
Coupling of shield connection	Directly to FE
Transmission speed	500 kbaud/2 Mbaud

Electrical Isolation/Isolation of the Voltage Areas	
	For device connection, please note the instructions and regulations in the "Installing the Fieldline Product Range" user manual FLS FLM SYS INST UM E (Order No. 26 98 97 3).

Separate Potentials in the FLM DO 8 M12	
- Test Distance	- Test Voltage
24 V supply (bus logic) / FE	500 V AC, 50 Hz, 1 min
24 V supply (bus logic) / digital outputs (actuator supply)	500 V AC, 50 Hz, 1 min
24 V supply (bus logic) / local bus	500 V AC, 50 Hz, 1 min
Digital outputs (actuator supply) / FE	500 V AC, 50 Hz, 1 min
Digital outputs (actuator supply) / local bus	500 V AC, 50 Hz, 1 min
Local bus / FE	500 V AC, 50 Hz, 1 min

Ordering Data

Description	Order Designation	Order No.
Fieldline modular device with eight digital outputs	FLM DO 8 M12	27 36 29 1
Protective caps (for unused sockets) pack of 5	IBS IP PROT-IO	27 59 91 9
Protective caps (for unused connectors) pack of 5	PROT-M12-M	27 36 19 4
Shielded connector, 5-pos. female connector, B-encoded, for the incoming local bus	SACC-M12FSB-5SC SH	15 13 59 6
Shielded connector, 5-pos. male connector, B-encoded, for the outgoing local bus	SACC-M12MSB-5SC SH	15 13 57 0
Markers pack of 10	ZBF 12:UNBEDRUCKT	08 09 73 5
"Installing the Fieldline Product Range" user manual	FLS FLM SYS INST UM E	26 98 97 3
"Configuring an INTERBUS System Using Devices in the Fieldline Product Range" user manual	FLS FLM IB SYS PRO UM E	26 99 06 6
"Configuring a PROFIBUS DP System Using Devices in the Fieldline Product Range" user manual	FLS FLM PB SYS PRO UM E	26 99 07 9
"Configuring a DeviceNet™ System Using Devices in the Fieldline Product Range" user manual	FLS FLM DN SYS PRO UM E	26 99 08 2
"Configuring a CANopen System Using Devices in the Fieldline Product Range" user manual	FLS FLM CO SYS PRO UM E	26 99 09 5
Additional accessories for connecting the actuators can be found in the Phoenix Contact PLUSCON catalog.		



Make sure you always use the latest documentation.
It can be downloaded at www.phoenixcontact.com.

Phoenix Contact GmbH & Co. KG
Flachsmarktstr. 8
32825 Blomberg
Germany



+49 - 52 35 - 30 0



+49 - 52 35 - 34 12 00



www.phoenixcontact.com



Worldwide Locations:

www.phoenixcontact.com/salesnetwork