

Apr.1.2017 Copyright 2017 HIROSE ELECTRIC CO., LTD. All Rights Reserved.

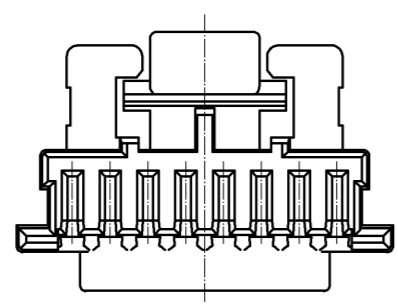
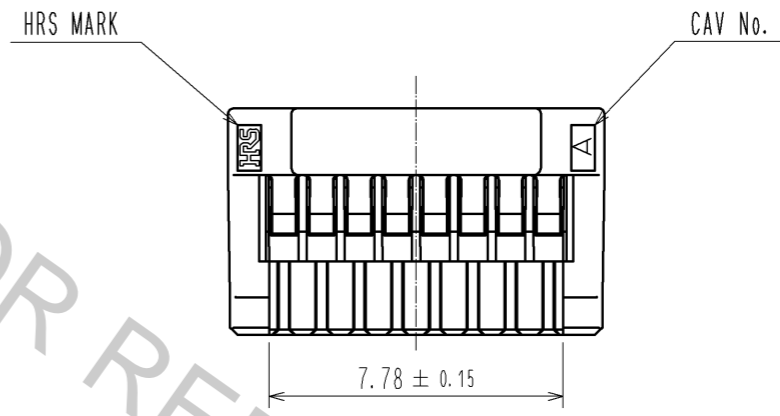
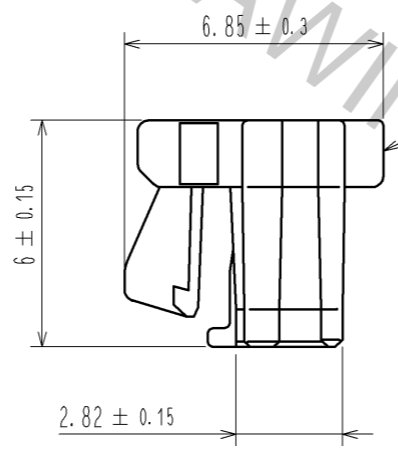
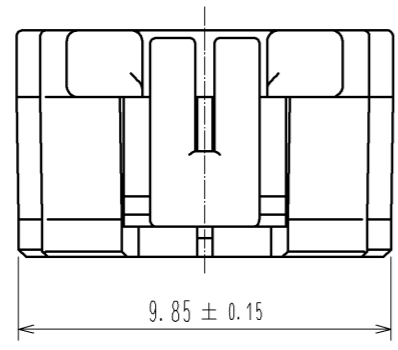
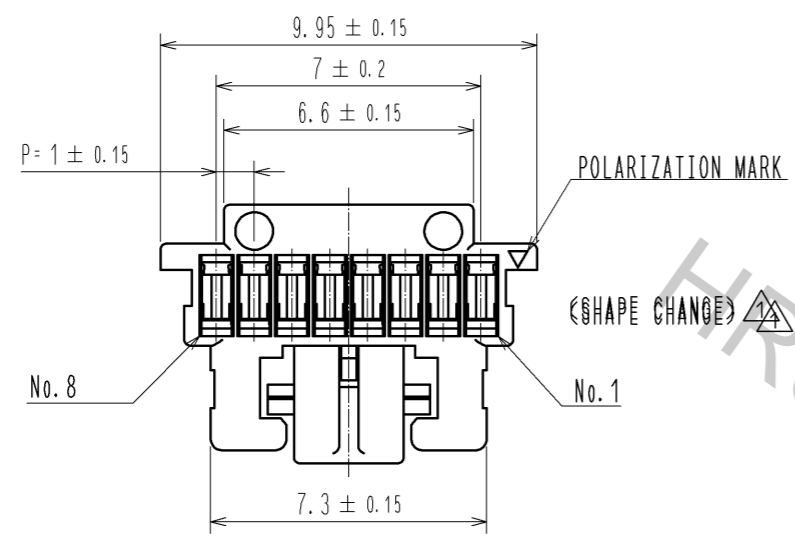

NOTE1. PER PACK:100 PIECES

NO.		MATERIAL		FINISH . REMARKS		1	PBT	UL94V-0. BLACK
UNITS mm		SCALE 5 : 1		COUNT 1	DESCRIPTION OF REVISIONS DIS-H-005903	DESIGNED KT. ISHII	CHECKED OM. MIYAMOTO	DATE 11.06.16
HIROSE ELECTRIC CO., LTD.		APPROVED : KI. AKIYAMA		10.12.14		DRAWING NO. EDC3-329667-00		
		CHECKED : OM. MIYAMOTO		10.12.14		PART NO. DF50A-8S-1C		
		DESIGNED : TT. OHSAKO		10.12.14		CODE NO. CL665-1015-8-00		
		DRAWN : TT. OHSAKO		10.12.14				