

12A, 18V, 500kHz, ACOT™ Synchronous Step-Down Converter

General Description

The RT6242A/B is a synchronous step-down converter with Advanced Constant On-Time (ACOT™) mode control. The ACOT™ provides a very fast transient response with few external components. The low impedance internal MOSFET supports high efficiency operation with wide input voltage range from 4.5V to 18V. The proprietary circuit of the RT6242A/B enables to support all ceramic capacitors. The output voltage can be adjustable between 0.7V and 8V. The soft-start is adjustable by an external capacitor.

Ordering Information

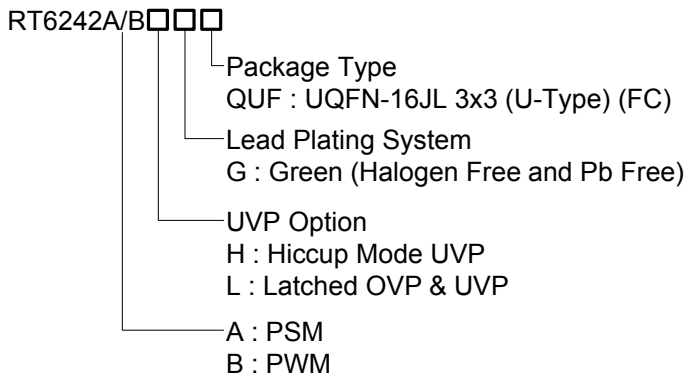

Note :

Richtek products are :

- ▶ RoHS compliant and compatible with the current requirements of IPC/JEDEC J-STD-020.
- ▶ Suitable for use in SnPb or Pb-free soldering processes.

Features

- 4.5V to 18V Input Voltage Range
- 12A Output Current
- 12mΩ Internal High-Side N-MOSFET and 5.4mΩ Internal Low-Side N-MOSFET
- Advanced Constant On-Time Control
- Fast Transient Response
- Support All Ceramic Capacitors
- Up to 95% Efficiency
- Adjustable Switching Frequency from 300kHz to 700kHz
- Adjustable Output Voltage from 0.7V to 8V
- Adjustable Soft-Start
- Pre-bias Start-Up
- Adjustable Current Limit from 6A to 16A
- Cycle-by-Cycle Over Current Protection
- Power Good Output
- Input Under-Voltage Lockout
- Hiccup Mode Under-Voltage Protection
- Thermal Shutdown Protection

Applications

- Industrial and Commercial Low Power Systems
- Computer Peripherals
- LCD Monitors and TVs
- Green Electronics/Appliances
- Point of Load Regulation for High-Performance DSPs, FPGAs, and ASICs

Simplified Application Circuit

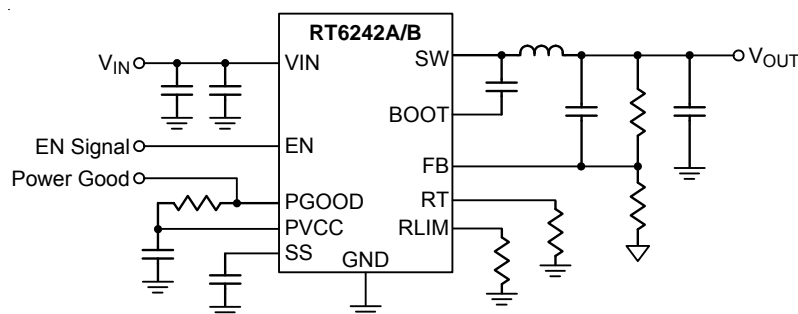

Pin Configurations

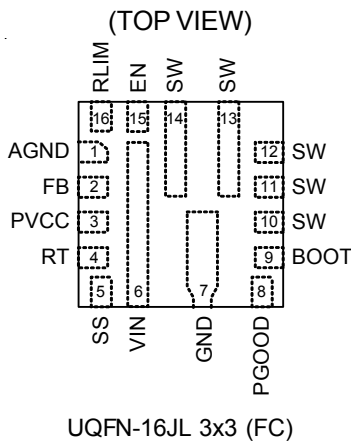

Marking Information

RT6242AHGQUF

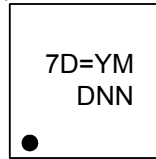

7D= : Product Code
YMDNN : Date Code

RT6242ALGQUF

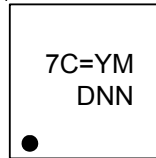

7C= : Product Code
YMDNN : Date Code

RT6242BHGQUF

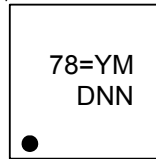

78= : Product Code
YMDNN : Date Code

RT6242BLGQUF

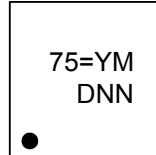

75= : Product Code
YMDNN : Date Code

Functional Pin Description

Pin No.	Pin Name	Pin Function
1	AGND	Analog Ground.
2	FB	Feedback Voltage Input. It is used to regulate the output of the converter to a set value via an external resistive voltage divider. The feedback reference voltage is 0.7V typically.
3	PVCC	Internal Regulator Output. Connect a 1 μ F capacitor to GND to stabilize output voltage.
4	RT	An External Timing Resistor Adjusts the Switching Frequency of the Device.
5	SS	Soft-Start Time Setting. An external capacitor should be connected between this pin and GND.
6	VIN	Power Input. The input voltage range is from 4.5V to 18V. Must bypass with a suitably large ($\geq 10\mu\text{F} \times 2$) ceramic capacitor.
7	GND	Ground.
8	PGOOD	Power Good Indicator Open-Drain Output.
9	BOOT	Bootstrap. This capacitor is needed to drive the power switch's gate above the supply voltage. It is connected between SW and BOOT pins to form a floating supply across the power switch driver. A 0.1 μ F capacitor is recommended for use.
10 to 14	SW	Switch Node. Connect this pin to an external L-C filter.
15	EN	Enable Control Input. A logic-high enables the converter; a logic-low forces the IC into shutdown mode reducing the supply current to less than 10 μ A.
16	RLIM	An External Resistor Adjusts the Current Limit of the Device.

Function Block Diagram

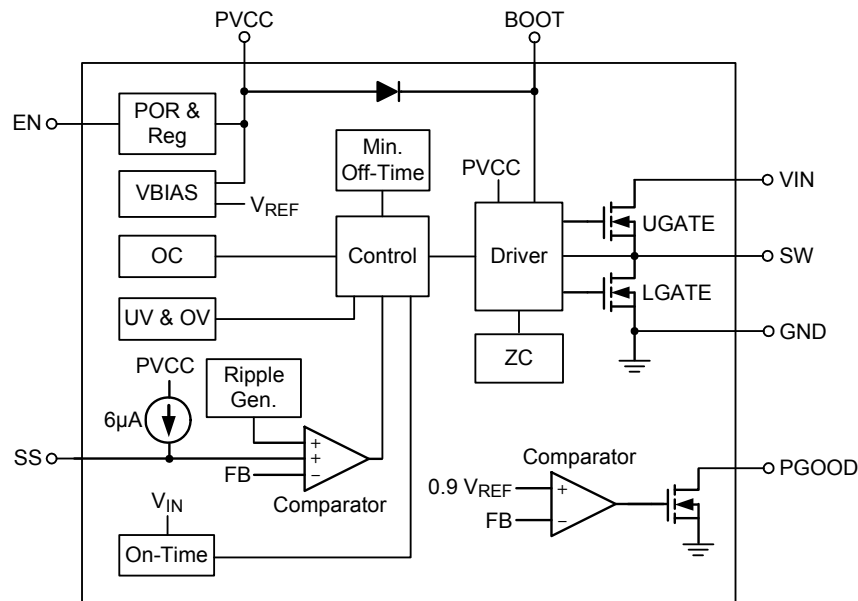

Operation

The RT6242A/B is a synchronous step-down converter with advanced Constant On-Time control mode. Using the ACOT™ control mode can reduce the output capacitance and fast transient response. It can minimize the component size without additional external compensation network.

Power Good

After soft-start has finished, the power good function will be activated. The PGGOOD pin is an open-drain output. If the FB voltage is lower than 85% VREF, the PGGOOD pin will be pulled low.

PVCC

The regulator provides 5V power to supply the internal control circuit. 1µF ceramic capacitor for decoupling and stability is required.

Soft-Start

In order to prevent the converter output voltage from overshooting during the startup period, the soft-start function is necessary. The soft-start time is adjustable by an external capacitor.

Current Protection

The inductor current is monitored via the internal switches cycle-by-cycle. Once the output voltage drops under UV threshold, the RT6242A/B will enter hiccup mode.

UVLO Protection

To protect the chip from operating at insufficient supply voltage, the UVLO is needed. When the input voltage of VIN is lower than the UVLO falling threshold voltage, the device will be lockout.

Thermal Shutdown

When the junction temperature exceeds the OTP threshold value, the IC will shut down the switching operation. Once the junction temperature cools down and is lower than the OTP lower threshold, the converter will autocratically resume switching.

Absolute Maximum Ratings (Note 1)

- Supply Voltage, V_{IN} ----- -0.3V to 20V
- Switch Voltage, SW ----- -0.3V to ($V_{IN} + 0.3V$)
- BOOT to SW ----- -0.3V to 6V
- EN to GND ----- -0.3V to 6V
- Other Pins Voltage ----- -0.3V to 6V
- Power Dissipation, P_D @ $T_A = 25^\circ C$
 UQFN-16JL 3x3 (FC) ----- 3.623W
- Package Thermal Resistance (Note 2)
 UQFN-16JL 3x3 (FC), θ_{JA} ----- 27.6°C/W
 UQFN-16JL 3x3 (FC), θ_{JC} ----- 5.6°C/W
- Junction Temperature Range ----- 150°C
- Lead Temperature (Soldering, 10 sec.) ----- 260°C
- Storage Temperature Range ----- -65°C to 150°C
- ESD Susceptibility (Note 3)
 HBM (Human Body Mode) ----- 2kV

Recommended Operating Conditions (Note 4)

- Supply Voltage, V_{IN} ----- 4.5V to 18V
- Junction Temperature Range ----- -40°C to 125°C
- Ambient Temperature Range ----- -40°C to 85°C

Electrical Characteristics

($V_{IN} = 12V$, $T_A = 25^\circ C$, unless otherwise specified)

Parameter	Symbol	Test Conditions	Min	Typ	Max	Unit
Supply Current						
Shutdown Current	ISHDN	$V_{EN} = 0V$	--	1.5	10	μA
Quiescent Current	I_Q	$V_{EN} = 2V$, $V_{FB} = 1V$	--	0.8	1.2	mA
Logic Threshold						
EN Voltage	Logic-High		1.1	1.2	1.3	V
	Hysteresis		--	0.2	--	
VREF Voltage						
Feedback Threshold Voltage	V_{REF}	$4.5V \leq V_{IN} \leq 18V$	0.693	0.7	0.707	V
Feedback Input Current	I_{FB}	$V_{FB} = 0.71V$	-0.1	--	0.1	μA
PVCC Output						
PVCC Output Voltage	V_{PVCC}	$6V \leq V_{IN} \leq 18V$, $0 < I_{PVCC} < 5mA$	--	5	--	V
Line Regulation		$6V \leq V_{IN} \leq 18V$, $I_{PVCC} = 5mA$	--	--	20	mV
Load Regulation		$0 < I_{PVCC} < 5mA$	--	--	100	mV
Output Current	I_{PVCC}	$V_{IN} = 6V$, $V_{PVCC} = 4V$	--	150	--	mA
RDS(ON)						
Switch On-Resistance	High-Side	$R_{DS(ON)_H}$	--	12	--	m Ω
	Low-Side	$R_{DS(ON)_L}$	--	5.4	--	

Parameter	Symbol	Test Conditions	Min	Typ	Max	Unit
Current Limit						
Current Limit	I _{LIM}	R _{LIM} = 66k	13	16	--	A
Thermal Shutdown						
Thermal Shutdown Threshold	T _{SD}		--	150	--	°C
On-Time Timer Control						
On-Time	t _{ON}	V _{IN} = 12V, V _{OUT} = 1.05V, R _{RT} = 150k	--	200	--	ns
Minimum On-Time	t _{ON(MIN)}		--	60	--	ns
Minimum Off-Time	t _{OFF(MIN)}		--	230	--	ns
Soft-Start						
SS Charge Current		V _{SS} = 0V	5	6	7	μA
UVLO						
UVLO Threshold		Wake Up V _{IN}	4	4.2	4.4	V
Hysteresis			--	0.5	--	
Power Good						
PGOOD Threshold		FB Rising	85	90	95	%
		FB Falling	--	80	--	
PGOOD Sink Current		PGOOD = 0.1V	10	20	--	mA
OVP and UVP Protection						
OVP Threshold			115	120	125	%
OVP Propagation Delay			--	10	--	μS
UVP Threshold			55	60	65	%
UVP Hysteresis			--	17	--	%
UVP Propagation Delay			--	250	--	μS
Switching Frequency	f _{SW}	R _{RT} = 106k	600	700	800	kHz
		R _{RT} = 150k	430	500	570	
		R _{RT} = 250k	250	300	350	

Note 1. Stresses beyond those listed “Absolute Maximum Ratings” may cause permanent damage to the device. These are stress ratings only, and functional operation of the device at these or any other conditions beyond those indicated in the operational sections of the specifications is not implied. Exposure to absolute maximum rating conditions may affect device reliability.

Note 2. θ_{JA} is measured at T_A = 25°C on a high effective thermal conductivity four-layer test board.

Note 3. Devices are ESD sensitive. Handling precaution is recommended.

Note 4. The device is not guaranteed to function outside its operating conditions.

Typical Application Circuit

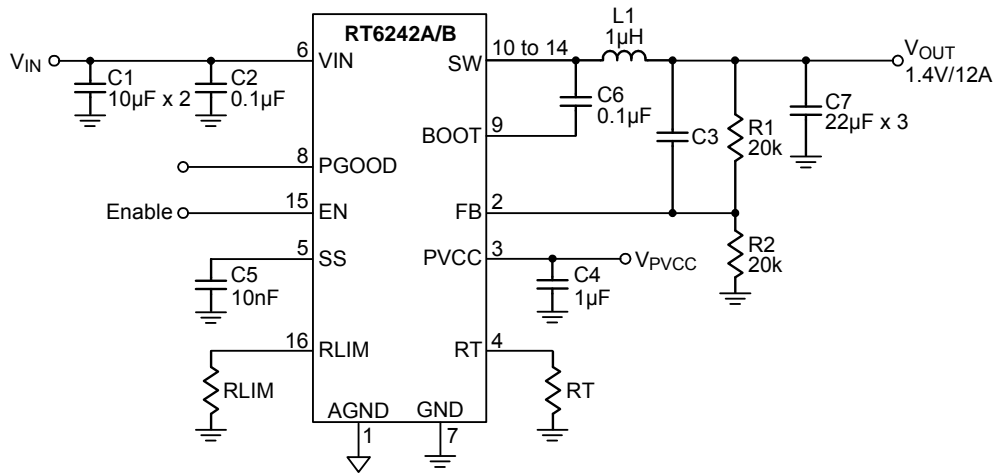

$R_{LIM} = 172k$, OCP typical 6A

$R_{LIM} = 94k$, OCP typical 11.4A

$R_{LIM} = 80k$, OCP typical 13.3A

$R_{LIM} = 66k$, OCP typical 16A

Table 1. Suggested Component Values

V_{OUT} (V)	R1 (k Ω)	R2 (k Ω)	C3 (pF)	L1 (μ H)	C7 (μ F)
1	8.66	20	--	1	66
1.4	20	20	--	1	66
1.8	31.6	20	10	1	66
2.5	51.1	20	10	1.2	66
5	124	20	22	1.5	66

Typical Operating Characteristics

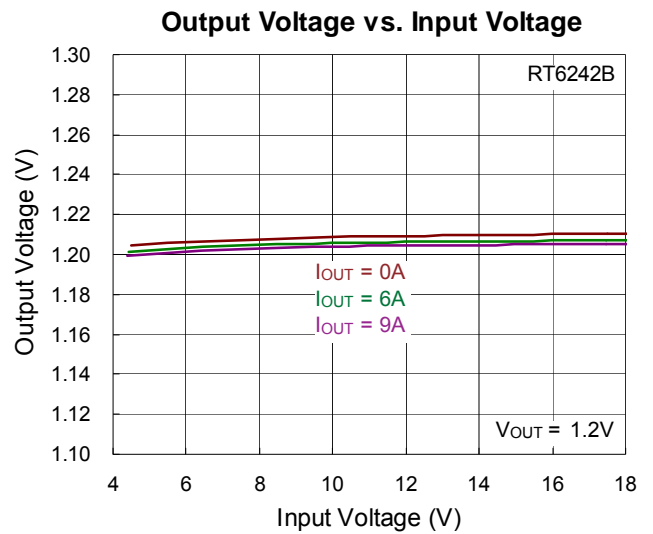
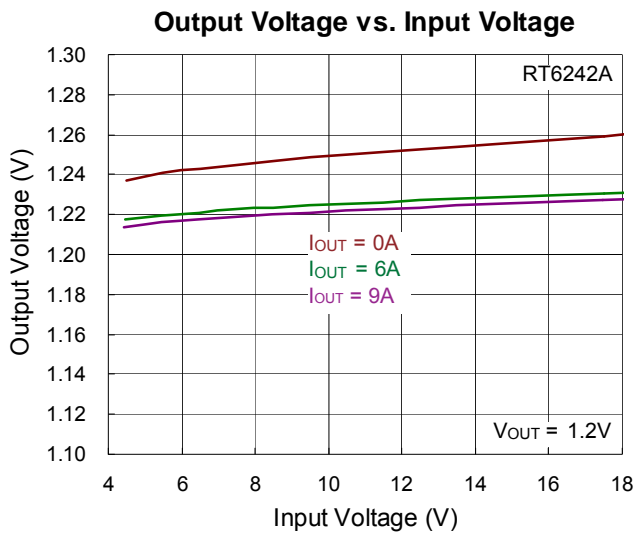
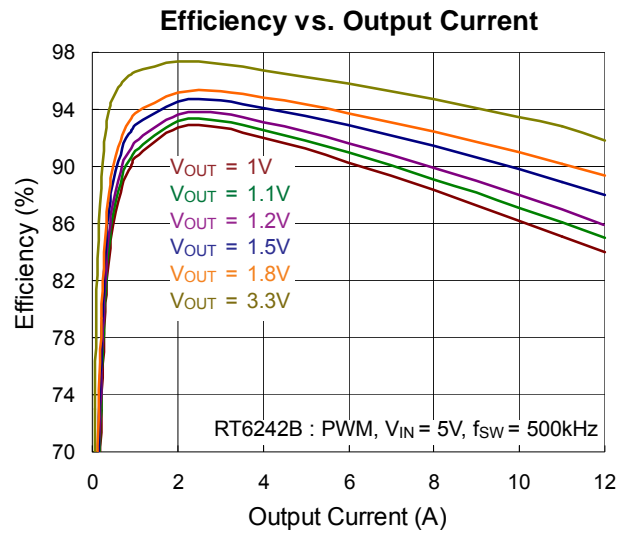
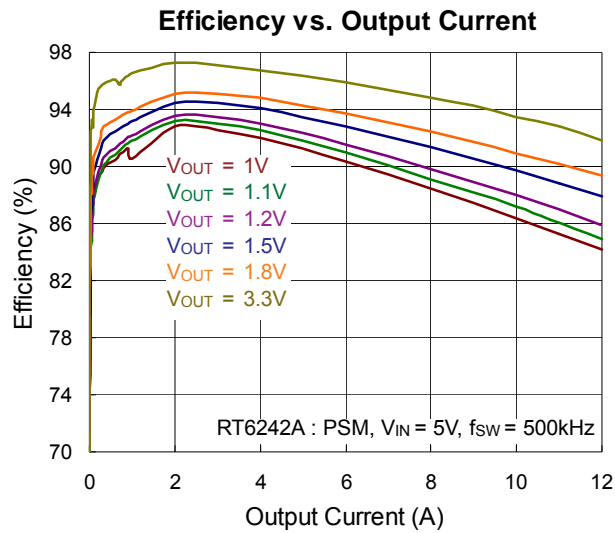
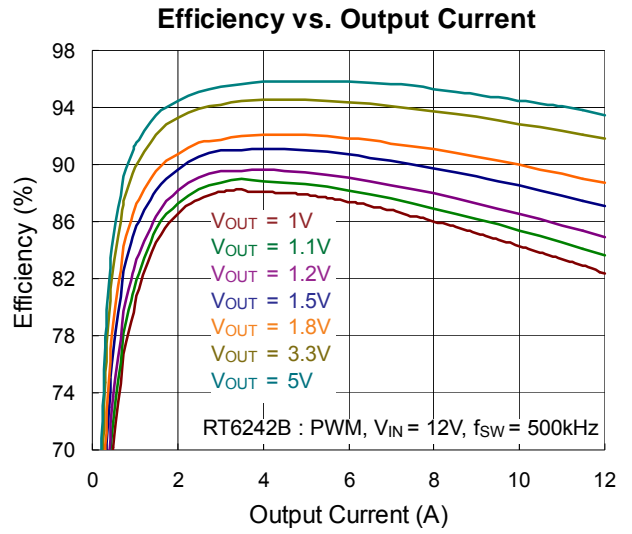
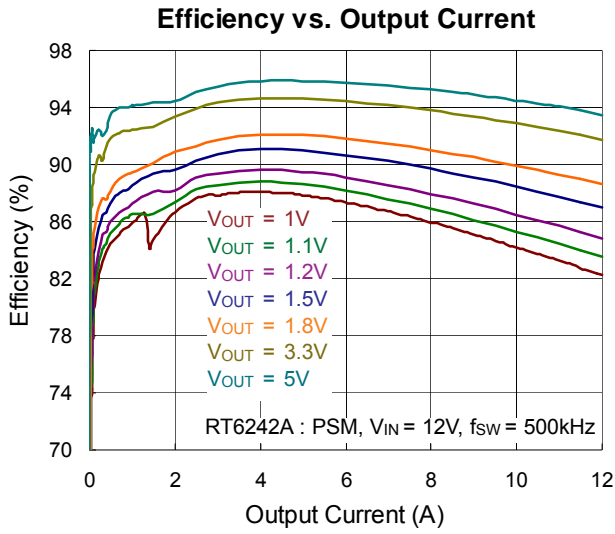

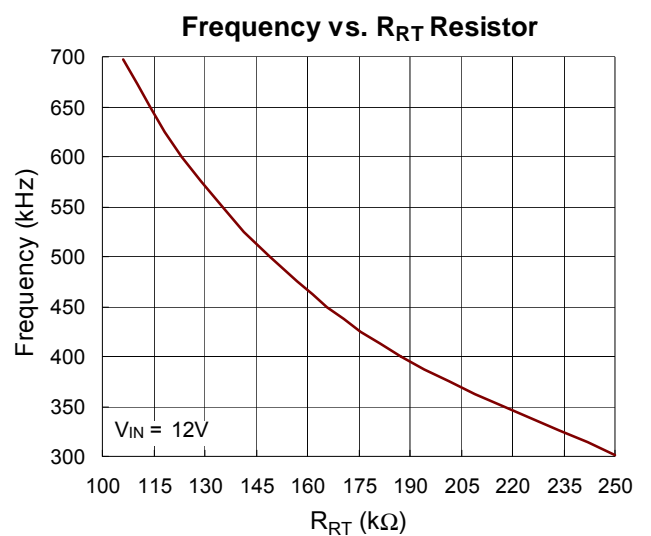
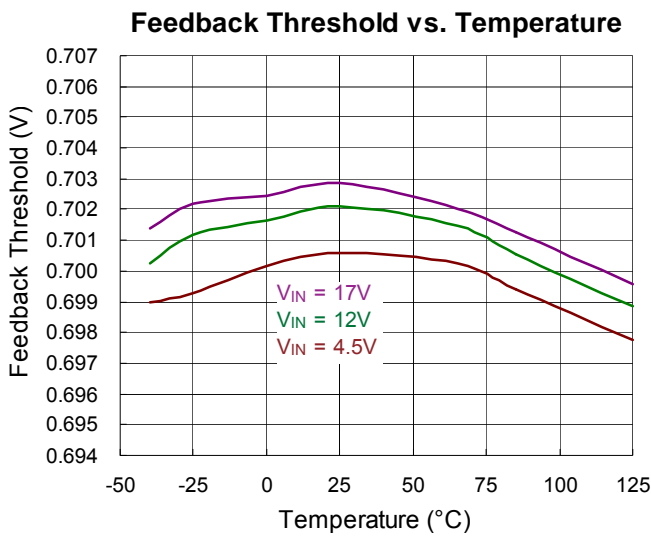
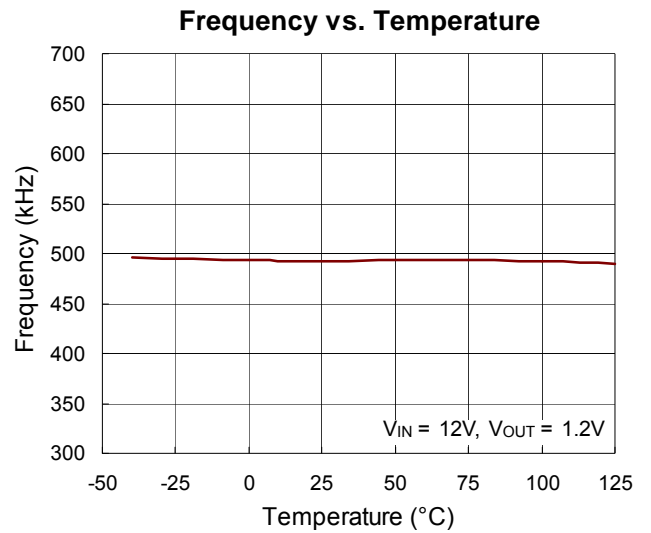
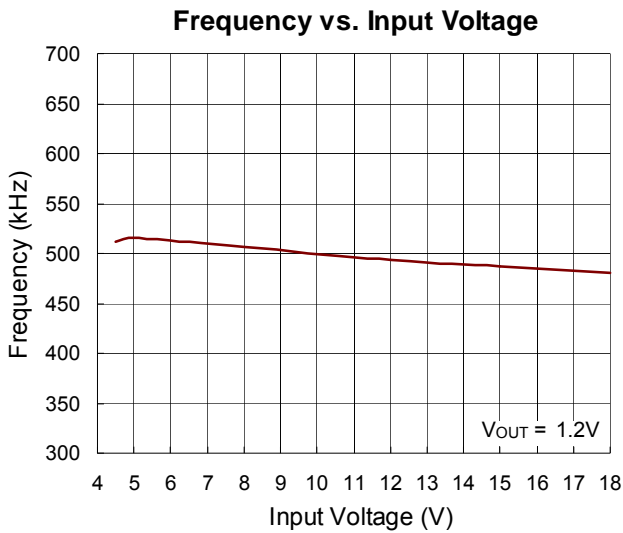
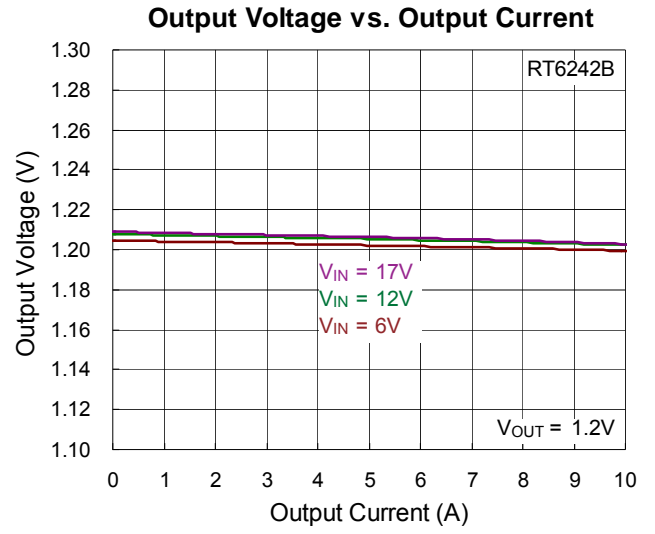
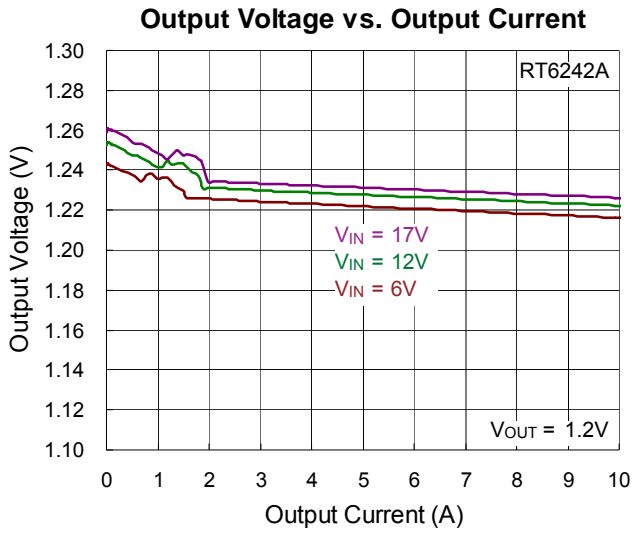

Load Transient Response

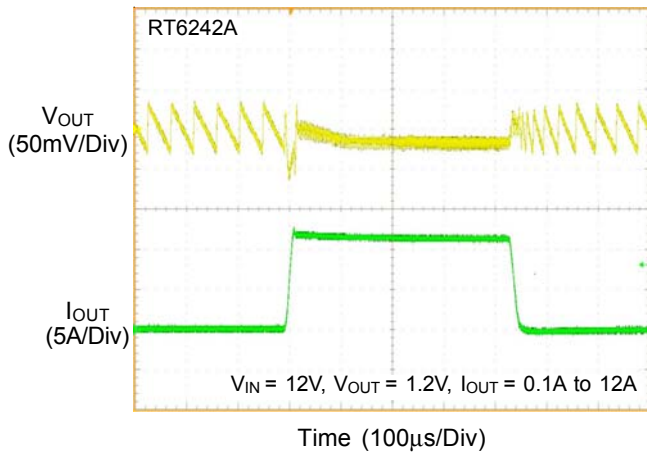

Load Transient Response

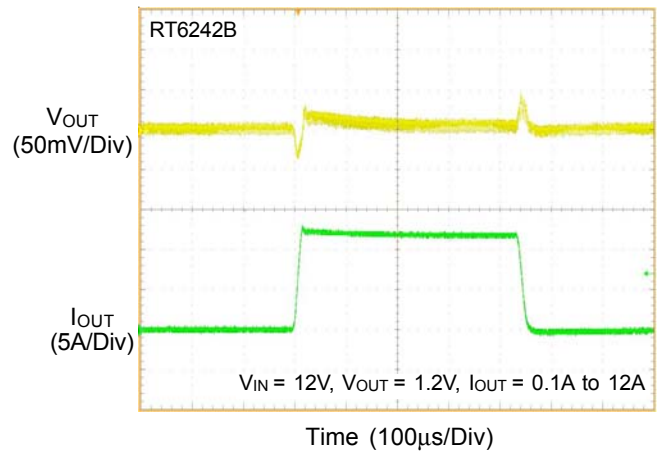

Load Transient Response

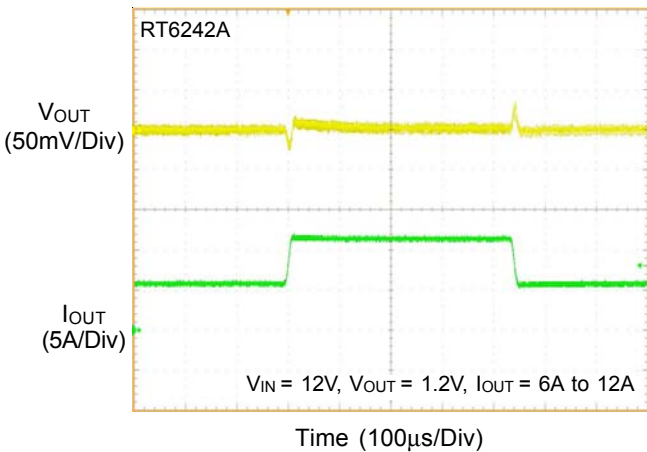

Load Transient Response

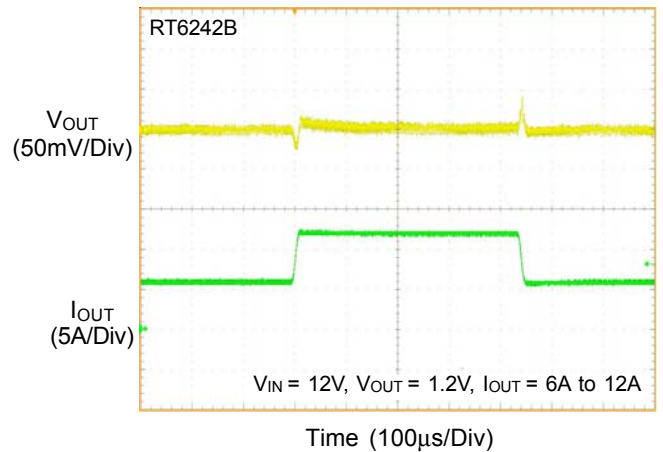

Output Ripple Voltage

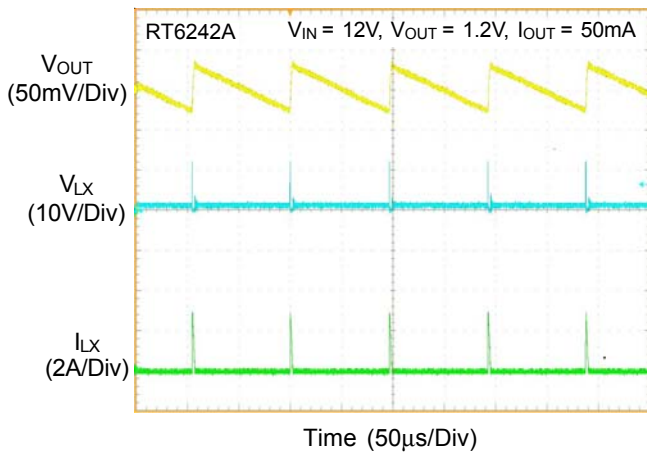

Output Ripple Voltage

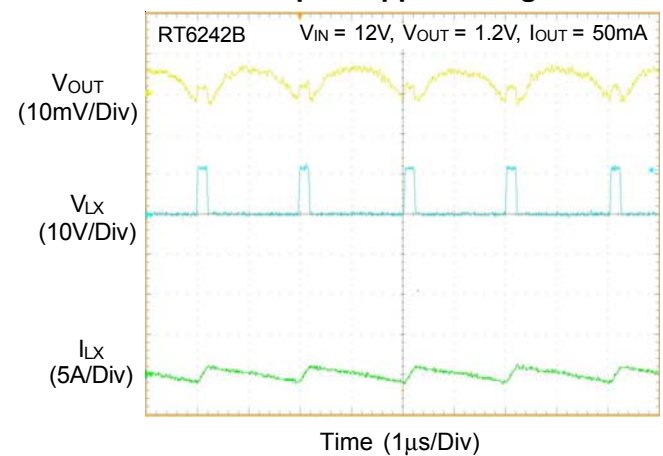

Output Ripple Voltage

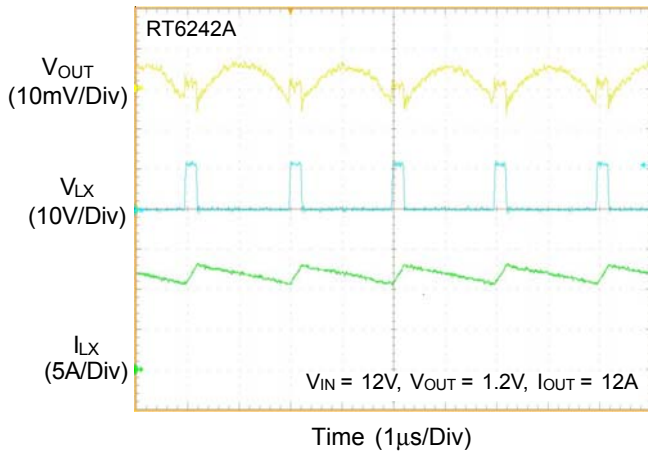

Output Ripple Voltage

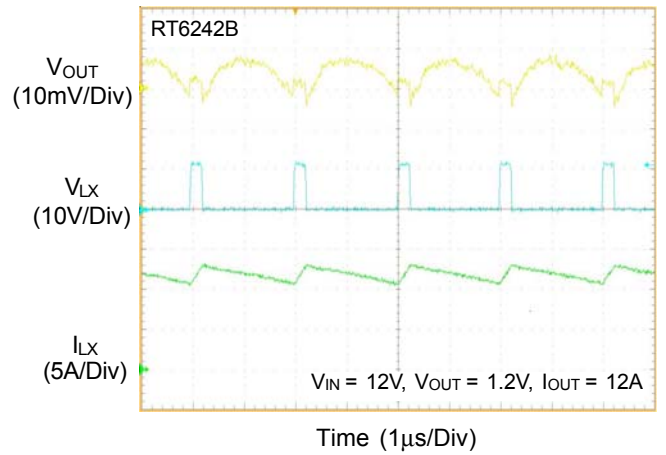

Power On from EN

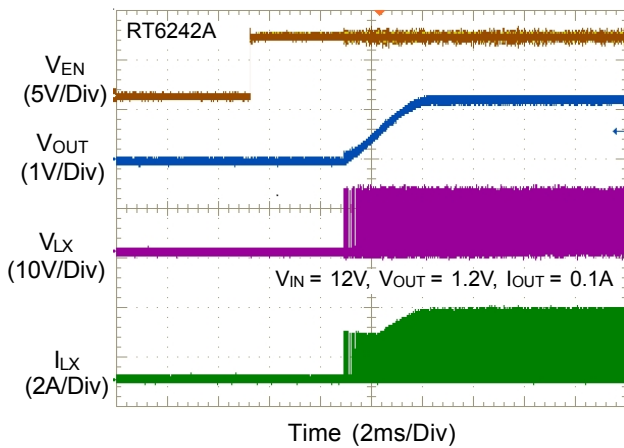

Power Off from EN

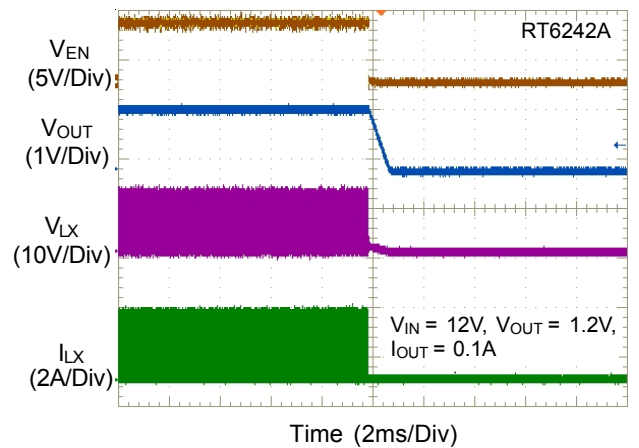

Power On from EN

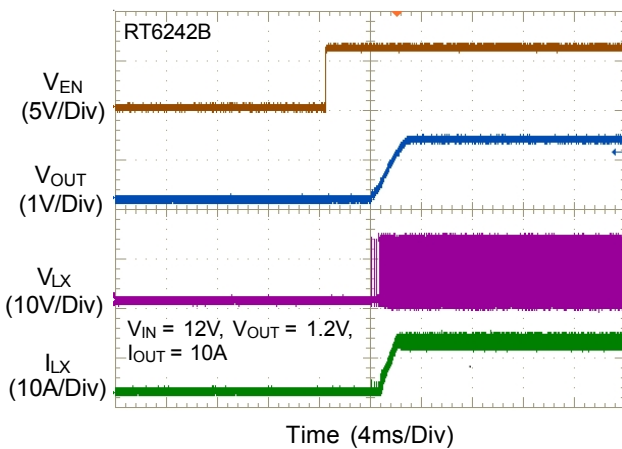

Power Off from EN

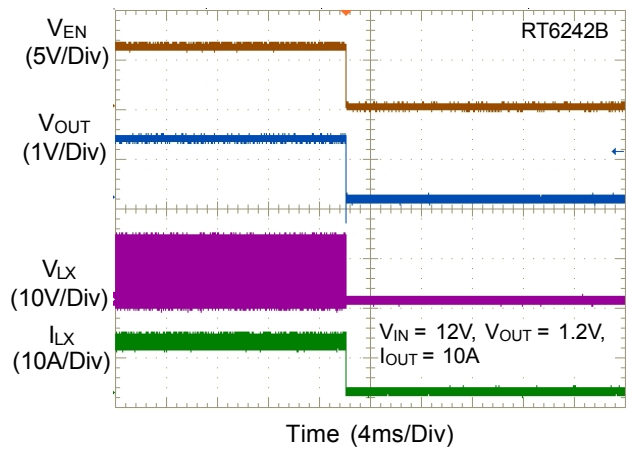

UVP Short (Latch Mode)

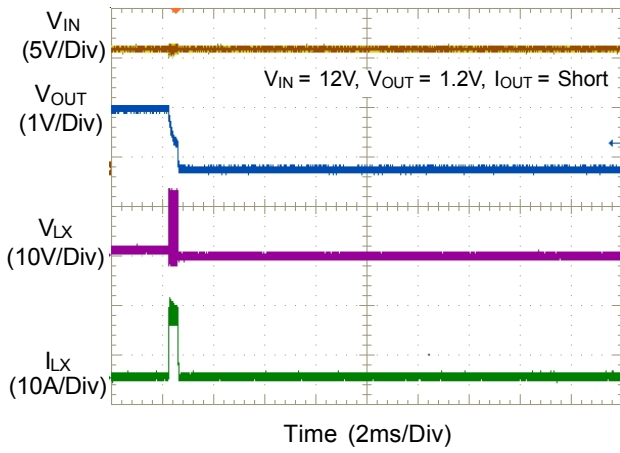

UVP Short (Hiccup Mode)

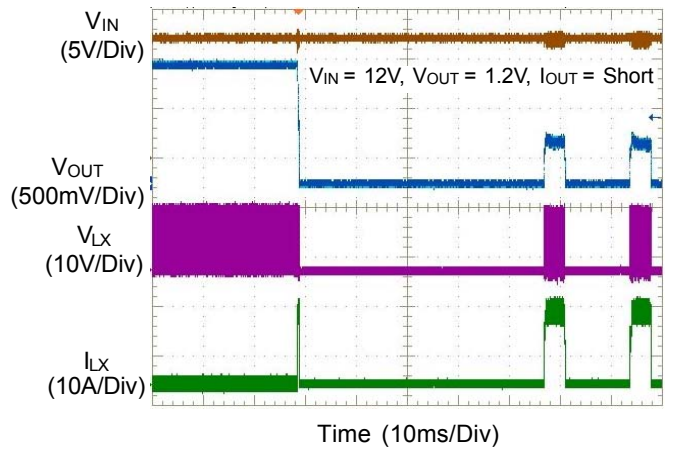

Application Information

Inductor Selection

Selecting an inductor involves specifying its inductance and also its required peak current. The exact inductor value is generally flexible and is ultimately chosen to obtain the best mix of cost, physical size, and circuit efficiency. Lower inductor values benefit from reduced size and cost and they can improve the circuit's transient response, but they increase the inductor ripple current and output voltage ripple and reduce the efficiency due to the resulting higher peak currents. Conversely, higher inductor values increase efficiency, but the inductor will either be physically larger or have higher resistance since more turns of wire are required and transient response will be slower since more time is required to change current (up or down) in the inductor. A good compromise between size, efficiency, and transient response is to use a ripple current (ΔI_L) about 15% to 40% of the desired full output load current. Calculate the approximate inductor value by selecting the input and output voltages, the switching frequency (f_{SW}), the maximum output current ($I_{OUT(MAX)}$) and estimating a ΔI_L as some percentage of that current.

$$L = \frac{V_{OUT} \times (V_{IN} - V_{OUT})}{V_{IN} \times f_{SW} \times \Delta I_L}$$

Once an inductor value is chosen, the ripple current (ΔI_L) is calculated to determine the required peak inductor current.

$$\Delta I_L = \frac{V_{OUT} \times (V_{IN} - V_{OUT})}{V_{IN} \times f_{SW} \times L}$$

$$I_{L(PEAK)} = I_{OUT(MAX)} + \frac{\Delta I_L}{2}$$

$$I_{L(VALLY)} = I_{OUT(MAX)} - \frac{\Delta I_L}{2}$$

Inductor saturation current should be chosen over IC's current limit.

Input Capacitor Selection

The input filter capacitors are needed to smooth out the switched current drawn from the input power source and to reduce voltage ripple on the input. The actual capacitance value is less important than the RMS current rating (and voltage rating, of course). The RMS input ripple current (I_{RMS}) is a function of the input voltage, output voltage, and load current :

$$I_{RMS} = I_{OUT(MAX)} \times \frac{V_{OUT}}{V_{IN}} \sqrt{\frac{V_{IN}}{V_{OUT}} - 1}$$

Ceramic capacitors are most often used because of their low cost, small size, high RMS current ratings, and robust surge current capabilities. However, take care when these capacitors are used at the input of circuits supplied by a wall adapter or other supply connected through long, thin wires. Current surges through the inductive wires can induce ringing at the RT6242A/B input which could potentially cause large, damaging voltage spikes at V_{IN} . If this phenomenon is observed, some bulk input capacitance may be required. Ceramic capacitors (to meet the RMS current requirement) can be placed in parallel with other types such as tantalum, electrolytic, or polymer (to reduce ringing and overshoot).

Choose capacitors rated at higher temperatures than required. Several ceramic capacitors may be paralleled to meet the RMS current, size, and height requirements of the application. The typical operating circuit uses two 10 μ F and one 0.1 μ F low ESR ceramic capacitors on the input.

Output Capacitor Selection

The RT6242A/B are optimized for ceramic output capacitors and best performance will be obtained using them. The total output capacitance value is usually determined by the desired output voltage ripple level and transient response requirements for sag (undershoot on positive load steps) and soar (overshoot on negative load steps).

Output Ripple

Output ripple at the switching frequency is caused by the inductor current ripple and its effect on the output capacitor's ESR and stored charge. These two ripple components are called ESR ripple and capacitive ripple. Since ceramic capacitors have extremely low ESR and relatively little capacitance, both components are similar in amplitude and both should be considered if ripple is critical.

$$V_{RIPPLE} = V_{RIPPLE(ESR)} + V_{RIPPLE(C)}$$

$$V_{RIPPLE(ESR)} = \Delta I_L \times R_{ESR}$$

$$V_{RIPPLE(C)} = \frac{\Delta I_L}{8 \times C_{OUT} \times f_{SW}}$$

Feed-forward Capacitor (C_{ff})

The RT6242A/B are optimized for ceramic output capacitors and for low duty cycle applications. However for high-output voltages, with high feedback attenuation, the circuit's response becomes over-damped and transient response can be slowed. In high-output voltage circuits (V_{OUT} > 3.3V) transient response is improved by adding a small "feed-forward" capacitor (C_{ff}) across the upper FB divider resistor (Figure 1), to increase the circuit's Q and reduce damping to speed up the transient response without affecting the steady-state stability of the circuit. Choose a suitable capacitor value that following below step.

- ▶ Get the BW the quickest method to do transient response form no load to full load. Confirm the damping frequency. The damping frequency is BW.

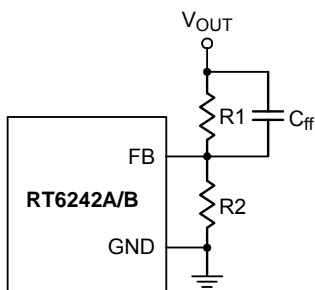
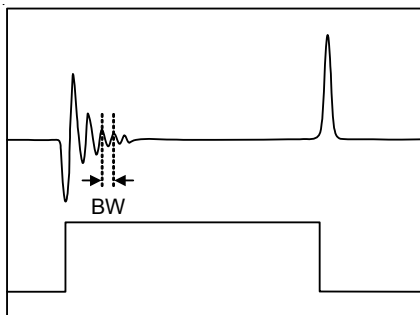

Figure 1. C_{ff} Capacitor Setting

- ▶ C_{ff} can be calculated base on below equation :

$$C_{ff} = \frac{1}{2 \times 3.1412 \times R1 \times BW \times 0.8}$$

Soft-Start (SS)

The RT6242A/B soft-start uses an external capacitor at SS to adjust the soft-start timing according to the following equation :

$$t \text{ (ms)} = \frac{C_{SS} \text{ (nF)} \times 0.7}{I_{SS} \text{ (}\mu\text{A)}}$$

Following below equation to get the minimum capacitance range in order to avoid UV occur.

$$T = \frac{C_{OUT} \times V_{OUT} \times 0.6 \times 1.2}{(I_{LIM} - \text{Load Current}) \times 0.8}$$

$$C_{SS} \geq \frac{T \times 6\mu\text{A}}{V_{REF}}$$

Do not leave SS unconnected.

Enable Operation (EN)

For automatic start-up, the low-voltage EN pin must be connected to VIN with a 100kΩ resistor. EN can be externally pulled to VIN by adding a resistor-capacitor delay (R_{EN} and C_{EN} in Figure 2). Calculate the delay time using EN's internal threshold where switching operation begins (1.2V, typical).

An external MOSFET can be added to implement digital control of EN (Figure 3). In this case, a 100kΩ pull-up resistor, R_{EN}, is connected between VIN and the EN pin. MOSFET Q1 will be under logic control to pull down the EN pin. To prevent enabling circuit when VIN is smaller than the V_{OUT} target value or some other desired voltage level, a resistive voltage divider can be placed between the input voltage and ground and connected to EN to create an additional input under voltage lockout threshold (Figure 4).

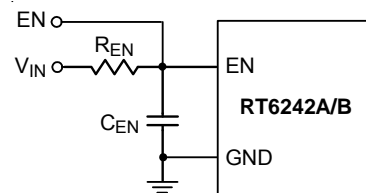

Figure 2. External Timing Control

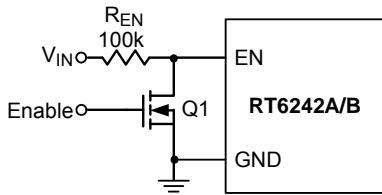

Figure 3. Digital Enable Control Circuit

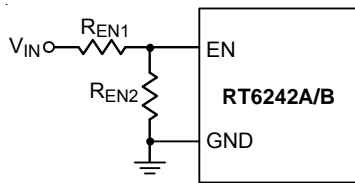

Figure 4. Resistor Divider for Lockout Threshold Setting

Output Voltage Setting

Set the desired output voltage using a resistive divider from the output to ground with the midpoint connected to FB. The output voltage is set according to the following equation :

$$V_{OUT} = 0.7 \times (1 + R1 / R2)$$

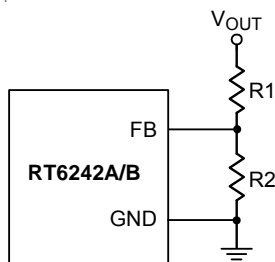

Figure 5. Output Voltage Setting

Place the FB resistors within 5mm of the FB pin. Choose R2 between 10kΩ and 100kΩ to minimize power consumption without excessive noise pick-up and calculate R1 as follows :

$$R1 = \frac{R2 \times (V_{OUT} - 0.7)}{0.7}$$

For output voltage accuracy, use divider resistors with 1% or better tolerance.

External BOOT Bootstrap Diode

When the input voltage is lower than 5.5V it is recommended to add an external bootstrap diode between VIN (or VINR) and the BOOT pin to improve enhancement of the internal MOSFET switch and improve efficiency. The bootstrap diode can be a low cost one such as 1N4148 or BAT54.

External BOOT Capacitor Series Resistance

The internal power MOSFET switch gate driver is optimized to turn the switch on fast enough for low power loss and good efficiency, but also slow enough to reduce EMI. Switch turn-on is when most EMI occurs since V_{SW} rises rapidly. During switch turn-off, SW is discharged relatively slowly by the inductor current during the dead time between high-side and low-side switch on-times. In some cases it is desirable to reduce EMI further, at the expense of some additional power dissipation. The switch turn-on can be slowed by placing a small (<47Ω) resistance between BOOT and the external bootstrap capacitor. This will slow the high-side switch turn-on and V_{SW} 's rise. To remove the resistor from the capacitor charging path (avoiding poor enhancement due to undercharging the BOOT capacitor), use the external diode shown in Figure 6 to charge the BOOT capacitor and place the resistance between BOOT and the capacitor/diode connection.

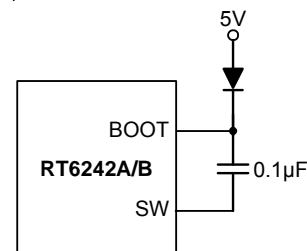

Figure 6. External Bootstrap Diode

PVCC Capacitor Selection

Decouple PVCC to GND with a 1µF ceramic capacitor. High grade dielectric (X7R, or X5R) ceramic capacitors are recommended for their stable temperature and bias voltage characteristics.

Output Under-Voltage Protection

Hiccup Mode

The RT6242AH/RT6242BH provides Hiccup Mode Under-Voltage Protection (UVP). When the FB voltage drops below 70% of the feedback reference voltage, the output voltage drops below the UVP trip threshold for longer than 250µs (typical) then IC's UVP is triggered. UVP function will be triggered to shut down switching operation. If the UVP condition remains for a period, the RT6242 will retry automatically. When the UVP condition is removed, the converter will resume operation. The UVP is disabled during soft-start period.

Latch Mode

For the RT6242AL/RT6242BL, it provides Latch-Off Mode Under Voltage Protection (UVP). When the FB voltage drops below 70% of the feedback reference voltage, the output voltage drops below the UVP trip threshold for longer than 250µs (typical) then IC's UVP is triggered. UVP function will be triggered to shut down switching operation. In shutdown condition, the RT6242 can be reset by EN pin or power input VIN.

Current Limit

The RT6242 current limit is a cycle-by-cycle "valley" type, measuring the inductor current through the synchronous rectifier during the off-time while the inductor current ramps down. The current is determined by measuring the voltage between source and drain of the synchronous rectifier. If the inductor current exceeds the current limit, the on-time one-shot is inhibited (Mask high side signal) until the inductor current ramps down below the current limit. Thus, only when the inductor current is well below the current limit is another on time permitted. This arrangement prevents the average output current from greatly exceeding the guaranteed current limit value, as typically occurs with other valley-type current limits. If the output current exceeds the available inductor current (controlled by the current limit mechanism), the output voltage will drop. If it drops below the output under-voltage protection level, the IC will enter UVP protection.

The current limit of low side MOSFET is adjustable by an external resistor connected to the RLIM pin. The current limit range is from 6A to 16A.

Through extra resistor R_{LIM} connect to RLIM pin to setting the current limit value as Figure 7, below offer approximate formula equation for design reference :

$$R_{LIM} = \frac{1}{I_{LIM} \times 10^{-6} - 5.588 \times 10^{-7}}$$

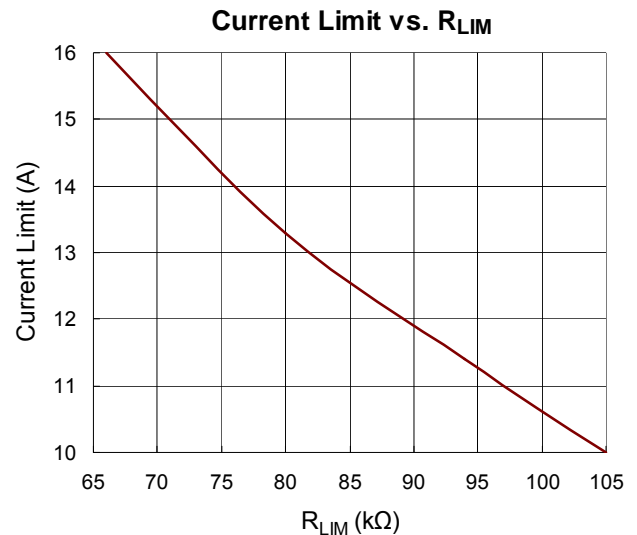

Figure 7. Current Limit vs. R_{LIM}

Output Over-Voltage Protection

If the output voltage V_{OUT} rises above the regulation level and lower 1.2 times regulation level, the high-side switch naturally remains off and the synchronous rectifier turns on. For RT6242BL, if the output voltage remains high, the synchronous rectifier remains on until the inductor current reaches the low side current limit. If the output voltage still remains high, then IC's switches remain that the synchronous rectifier turns on and high-side MOS keeps off to operate at typical 500kHz switching protection, again if inductor current reaches low side current limit, the synchronous rectifier will turn off until next protection clock. If the output voltage exceeds the OVP trip threshold (1.2 times regulation level) for longer than 5µs (typical), then IC's output Over-Voltage Protection (OVP) is triggered. RT6242BL chip enters latch mode.

For RT6242AL, if the output voltage V_{OUT} rises above the regulation level and lower 1.2 times regulation level, the high-side switch naturally remains off and the synchronous rectifier turns on until the inductor current reaches zero current. If the output voltage remains high, then IC's switches remain off. If the output voltage exceeds the OVP

trip threshold (1.2 times regulation level) for longer than 5µs (typical), the IC's OVP is triggered. RT6242AL chip enters latch mode.

For RT6242BH, if the output voltage remains high, the synchronous rectifier remains on until the inductor current reaches the low side current limit. If the output voltage still remains high, the synchronous rectifier turns on and high-side MOSFET keeps off to operate at typical 500kHz switching protection, again if inductor current reaches low side current limit, the synchronous rectifier will turn off until next protection clock. RT6242BH is without OVP latch function and recover when OV condition release.

For RT6242AH, if the output voltage remains high, the synchronous rectifier remains on until the inductor current reaches zero current. If the output voltage still remains high, then IC's switches remain off. RT6242AH is without OVP latch function and recover when OV condition release.

Switching Frequency Setting

The switching frequency can be set by using extra resistor R_{RT} . Switching frequency range is from 300kHz to 700kHz. Through extra resistor R_{RT} connect to RT pin to setting the switching frequency f_{SW} as Figure 8, below offer approximate formula equation :

Setting Frequency = f_{SW} (kHz)

$$R_{RT} = \frac{10^6}{f_{SW} \times (1.374 \times 10^{-5}) - 1.541 \times 10^{-4}}$$

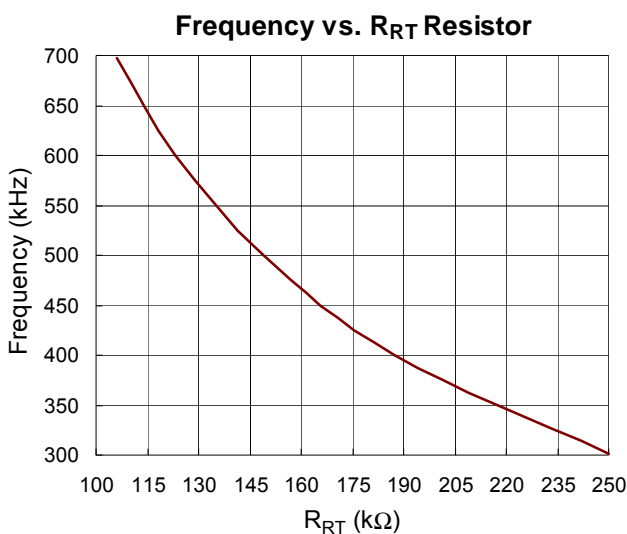

Figure 8. Frequency vs. R_{RT} Resistor

Thermal Considerations

For continuous operation, do not exceed absolute maximum junction temperature. The maximum power dissipation depends on the thermal resistance of the IC package, PCB layout, rate of surrounding airflow, and difference between junction and ambient temperature. The maximum power dissipation can be calculated by the following formula :

$$P_{D(MAX)} = (T_{J(MAX)} - T_A) / \theta_{JA}$$

where $T_{J(MAX)}$ is the maximum junction temperature, T_A is the ambient temperature, and θ_{JA} is the junction to ambient thermal resistance.

For recommended operating condition specifications, the maximum junction temperature is 125°C. The junction to ambient thermal resistance, θ_{JA} , is layout dependent. For UQFN-16JL 3x3 (FC) package, the thermal resistance, θ_{JA} , is 27.6°C/W on a standard four-layer thermal test board. The maximum power dissipation at $T_A = 25^\circ\text{C}$ can be calculated by the following formula :

$$P_{D(MAX)} = (125^\circ\text{C} - 25^\circ\text{C}) / (27.6^\circ\text{C/W}) = 3.623\text{W for UQFN-16JL 3x3 (FC) package}$$

The maximum power dissipation depends on the operating ambient temperature for fixed $T_{J(MAX)}$ and thermal resistance, θ_{JA} . The derating curve in Figure 9 allows the designer to see the effect of rising ambient temperature on the maximum power dissipation.

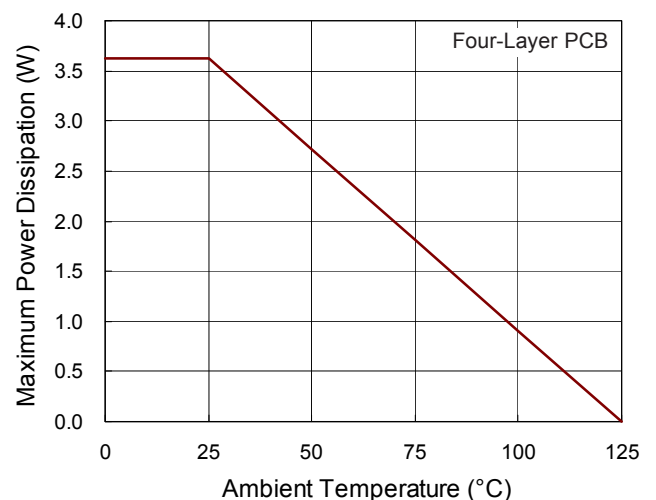

Figure 9. Derating Curve of Maximum Power Dissipation

Layout Consideration

- ▶ Follow the PCB layout guidelines for optimal performance of the device.
- ▶ Keep the traces of the main current paths as short and wide as possible.
- ▶ Put the input capacitor as close as possible to VIN and VIN pins.
- ▶ SW node is with high frequency voltage swing and should be kept at small area. Keep analog components away from the SW node to prevent stray capacitive noise pickup.
- ▶ Connect feedback network behind the output capacitors. Keep the loop area small. Place the feedback components near the device.
- ▶ Connect all analog grounds to common node and then connect the common node to the power ground behind the output capacitors.
- ▶ An example of PCB layout guide is shown in Figure 10 and Figure 11 for reference.

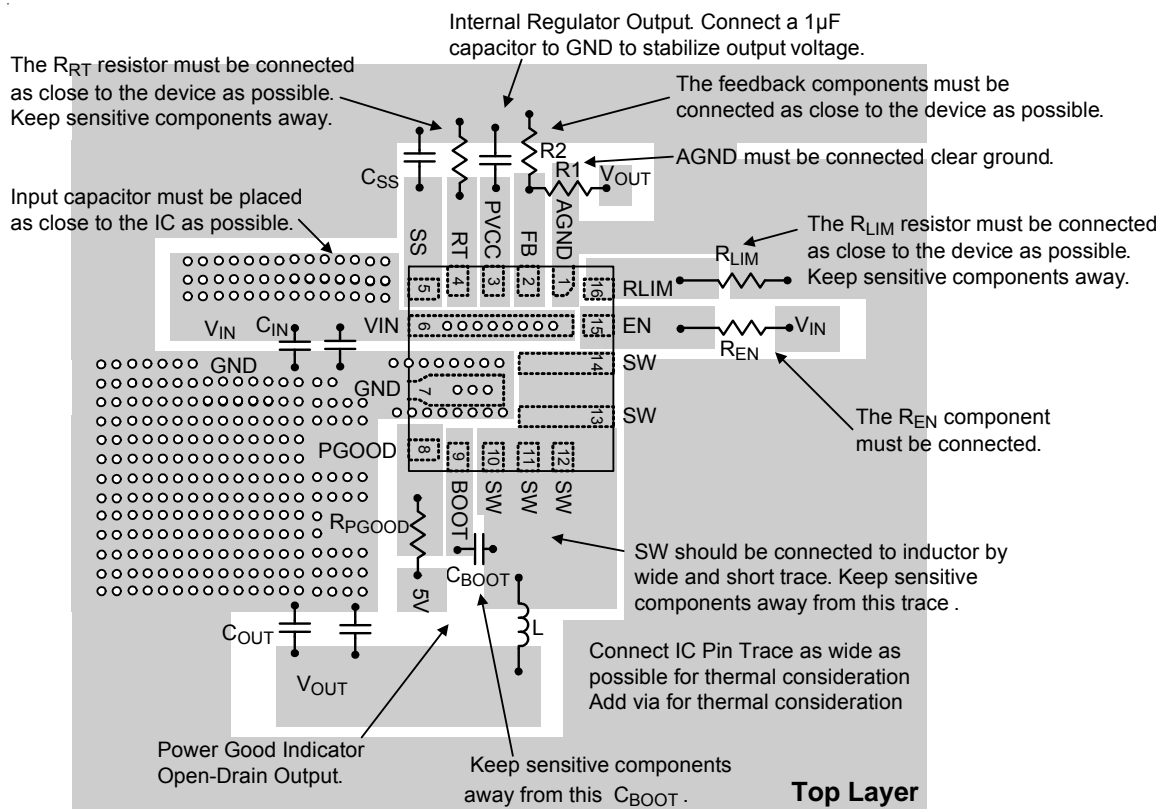

Figure 10. PCB Layout Guide (Top Layer)

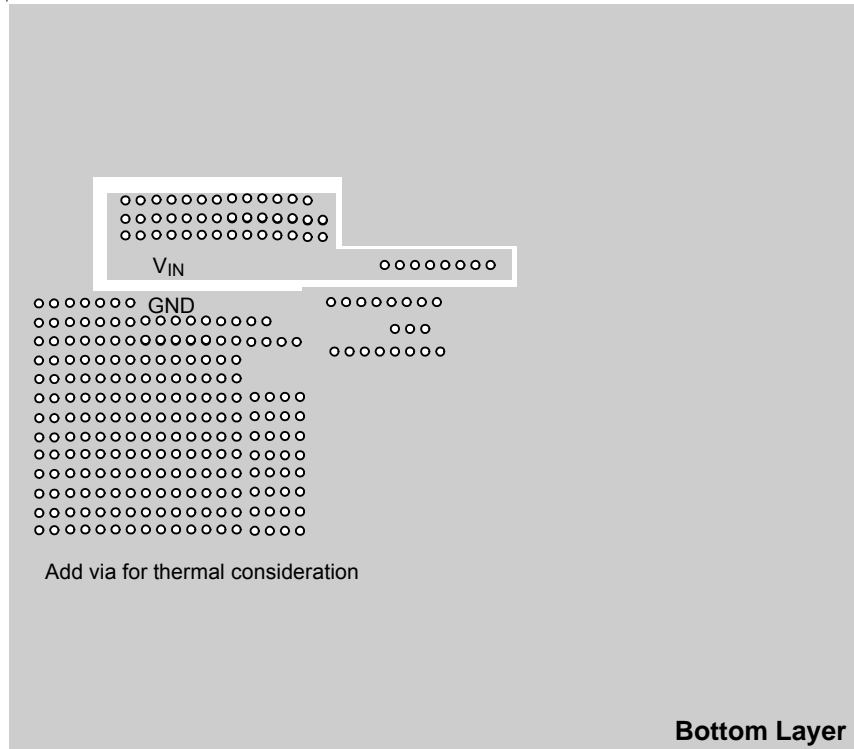

Figure 11. PCB Layout Guide (Bottom Layer)

Suggested Inductors for Typical Application Circuit

Component Supplier	Part No.	Inductance (μH)	DCR (mΩ)	Dimensions (mm)
WE	7443320100	1	1.85	12.1 x 11.4 x 9.5
WE	744325120	1.2	1.8	10.2 x 10.2 x 4.7
CYNTEC	CMMB104T-1R5MS	1.5	3.8	10.3 x 11.5 x 4

Recommended component selection for Typical Application.

Component Supplier	Part No.	Capacitance (μF)	Case Size
MURATA	GRM31CR61E106K	10	1206
TDK	C3225X5R1E106K	10	1206
TAIYO YUDEN	TMK316BJ106ML	10	1206
MURATA	GRM31CR60J476M	47	1206
TDK	C3225X5R0J476M	47	1210
TAIYO YUDEN	EMK325BJ476MM	47	1210
MURATA	GRM32ER71C226M	22	1210
TDK	C3225X5R1C226M	22	1210

Outline Dimension

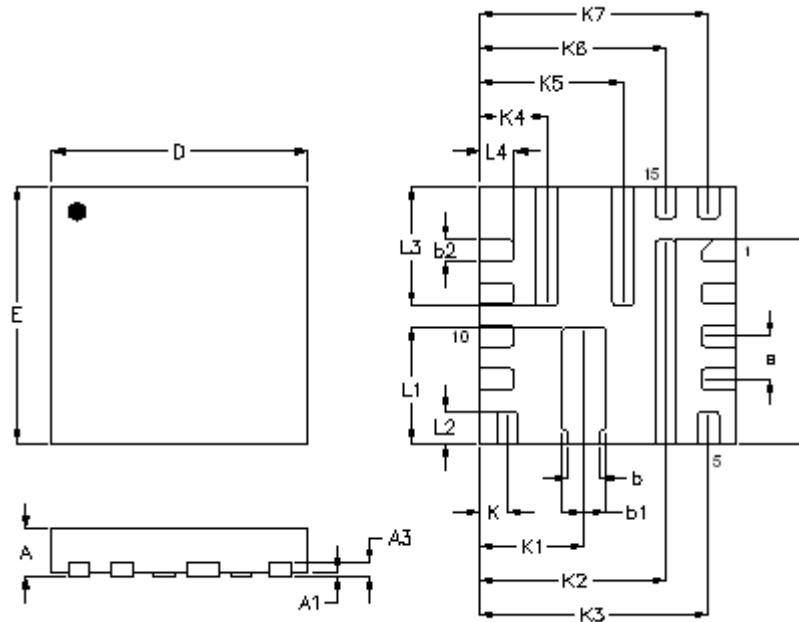

Symbol	Dimensions In Millimeters		Dimensions In Inches	
	Min.	Max.	Min.	Max.
A	0.500	0.600	0.020	0.024
A1	0.000	0.050	0.000	0.002
A3	0.100	0.175	0.004	0.007
D	2.900	3.100	0.114	0.122
E	2.900	3.100	0.114	0.122
b	0.320	0.420	0.013	0.017
b1	0.458	0.558	0.018	0.022
b2	0.200	0.300	0.008	0.012
L	2.325	2.425	0.092	0.095
L1	1.300	1.400	0.051	0.055
L2	0.325	0.425	0.013	0.017
L3	1.350	1.450	0.053	0.057
L4	0.350	0.450	0.014	0.018
e	0.500		0.020	
K	0.325		0.013	
K1	1.224		0.048	
K2	2.175		0.086	
K3	2.675		0.105	
K4	0.785		0.031	
K5	1.675		0.066	
K6	2.175		0.086	
K7	2.675		0.105	

U-Type 16JL QFN 3x3 (FC) Package

Footprint Information

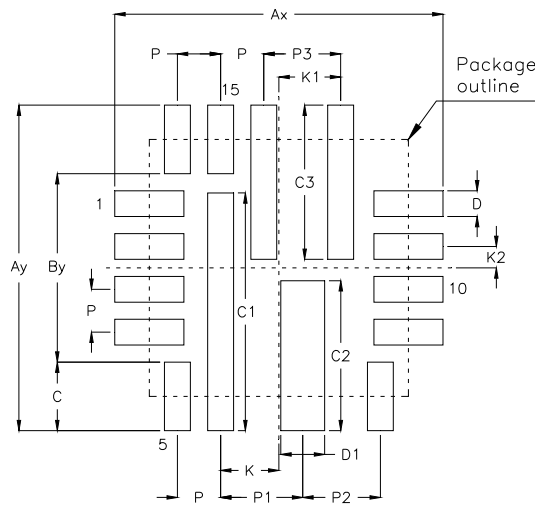

Package	Number of Pin	Footprint Dimension (mm)																Tolerance
		P	P1	P2	P3	Ay	By	Ax	C*12	C1	C2	C3*2	D*15	D1	K	K1	K2	
UQFN3*3-16J(FC)	16	0.500	0.951	0.899	0.890	3.800	2.200	3.800	0.800	2.775	1.750	1.800	0.300	0.508	0.675	0.715	0.250	±0.050

Richtek Technology Corporation

14F, No. 8, Tai Yuen 1st Street, Chupei City
 Hsinchu, Taiwan, R.O.C.
 Tel: (8863)5526789

Richtek products are sold by description only. Richtek reserves the right to change the circuitry and/or specifications without notice at any time. Customers should obtain the latest relevant information and data sheets before placing orders and should verify that such information is current and complete. Richtek cannot assume responsibility for use of any circuitry other than circuitry entirely embodied in a Richtek product. Information furnished by Richtek is believed to be accurate and reliable. However, no responsibility is assumed by Richtek or its subsidiaries for its use; nor for any infringements of patents or other rights of third parties which may result from its use. No license is granted by implication or otherwise under any patent or patent rights of Richtek or its subsidiaries.