

# PART No. 1487C9P

for more information visit

[www.hammfg.com](http://www.hammfg.com)

Data subject to change without notice

Isometric drawing Not to Scale

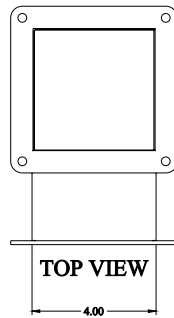

TOP VIEW

4.00

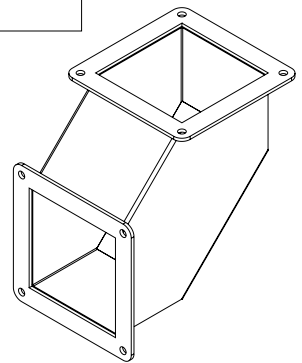

ISOMETRIC VIEW

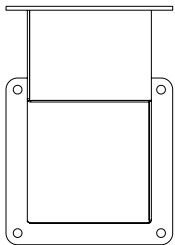

BACK VIEW

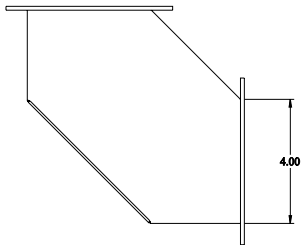

SIDE VIEW

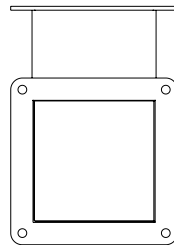

FRONT VIEW

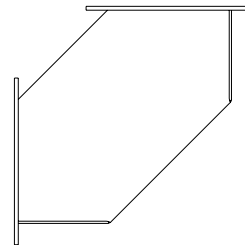

SIDE VIEW

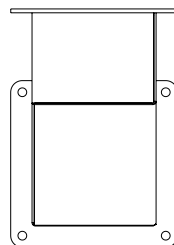

BOTTOM VIEW