

## Getting started with the Qi-based wireless power receiver optimized for wearable applications up to 2.5 W using STWLC33

### Introduction

The STEVAL-ISB043V1 is a Qi-based 2.5 W wireless power receiver evaluation board based on the [STWLC33](#) and suitable for wearable applications.

The STEVAL-ISB043V1 provides a complete kit, which includes the STWLC33 IC, firmware, layout and tools.

The device is powered by the RX coil attached to a 1.3 mm thick plastic fixture.

The STWLC33 firmware gives you the flexibility to modify parameters and settings to ensure proper STWLC33 use in the final application.

**Figure 1. STEVAL-ISB043V1 evaluation board**

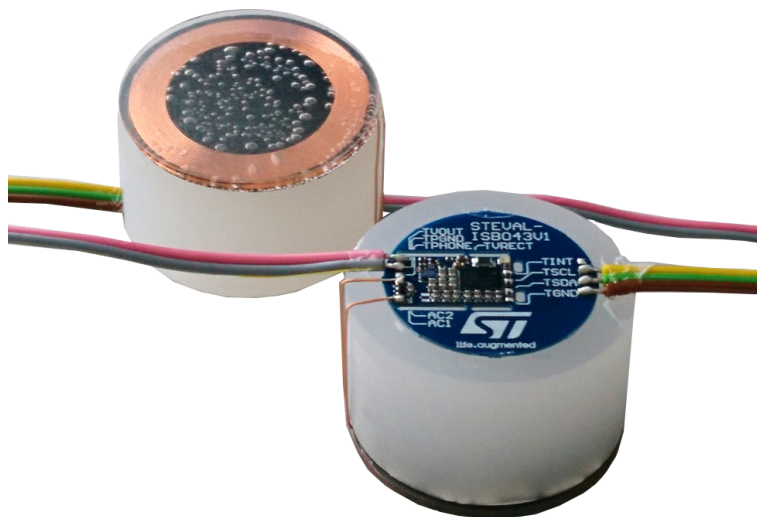

# 1 Getting started

## 1.1 Board overview

The board features:

- STWLC33 evaluation board for wearable applications using Würth coil 760308101309
- Up to 2.5 W output power
- Operates as voltage source
- Foreign object detection (FOD)
- I<sup>2</sup>C interface for communication with the host system
- Parameters and features adjustable via NVM memory
- Cost-effective 3-layer PCB
- 10x6 mm application area
- Complete kit (IC, firmware)
- RoHS compliant

### 1.1.1 Board configuration and test points

- TVOUT: power output
- TPGND: power output ground
- TPHONE: optional power output with back-to-back transistor isolation from TVOUT
- TSCL: I<sup>2</sup>C clock line
- TSDA: I<sup>2</sup>C data line
- TINT: interrupt output, open drain, active low
- TGND: digital interface ground
- TVRECT: test point to touch VRECT voltage

## 1.2 STWLC33 NVM configuration

The **STWLC33** NVM configuration differs from the default configuration in STWLC33 samples due to the small-sized receiver coil with limited output power (2.5 W).

The STEVAL-ISB043V1 evaluation board original NVM content can be restored by loading the file below:

```
s-00: 3E 14 19 28 0E 3C 09 05 0F 27 89 07 26 00 00 3D C0 07 81 02 14 0F 00 00 00 0
0 00 00 00 00 00 00
s-01: 3E 14 09 28 09 3C 09 05 0F 27 89 07 26 00 00 3D C0 07 81 02 14 00 00 02 04 0
0 00 00 00 00 00 00
s-02: 2A 0A 0A 00 00 FF 00 14 00 59 00 00 00 00 00 00 00 00 00 00 00 00 00 00 0
0 00 00 00 00 00 00
s-03: 00 16 00 01 02 03 00 00 00 00 00 00 00 00 00 0A 05 00 00 00 00 00 00 00 00 0
0 00 00 00 00 00 00
s-08: 9A 01 02 00 00 00 00 00 00 00 00 00 00 00 00 00 00 00 00 00 00 00 00 00 0
0 00 00 00 00 00 00
s-0B: 01 0A 00 02 0F 0C 40 0D 03 00 00 00 00 00 00 00 00 40 10 02 05 06 09 0E 00 00 0
0 00 00 00 00 00 00
s-0D: 80 02 07 00 20 00 03 55 D2 0A A1 07 23 0D 05 27 27 29 35 0F 74 A0 21 00 00 0
0 00 00 00 00 00 00
```

### 1.3 GUI: I<sup>2</sup>C register access

Most fields in the GUI application correspond to a single I<sup>2</sup>C register (for further details, see [STWLC33](#) datasheet on [www.st.com](#)).

This section details the more common complex operations.

The **Registers** tab contains three sub-tabs related to Rx mode I<sup>2</sup>C register controls.

Through the **Interrupt registers** sub-tab, you can monitor the following registers:

- Status\_Rx
- INT\_Rx
- INT\_Enable\_Rx
- INT\_Clear\_Rx

The GUI directly reads or writes the target register.

The **Interrupt clear** button is a more complex operation which first writes the **INT\_Clear\_Rx** register and then writes 1 in the **Clr\_Int bit in Com** register.

**Figure 2. Interrupt registers sub-tab**

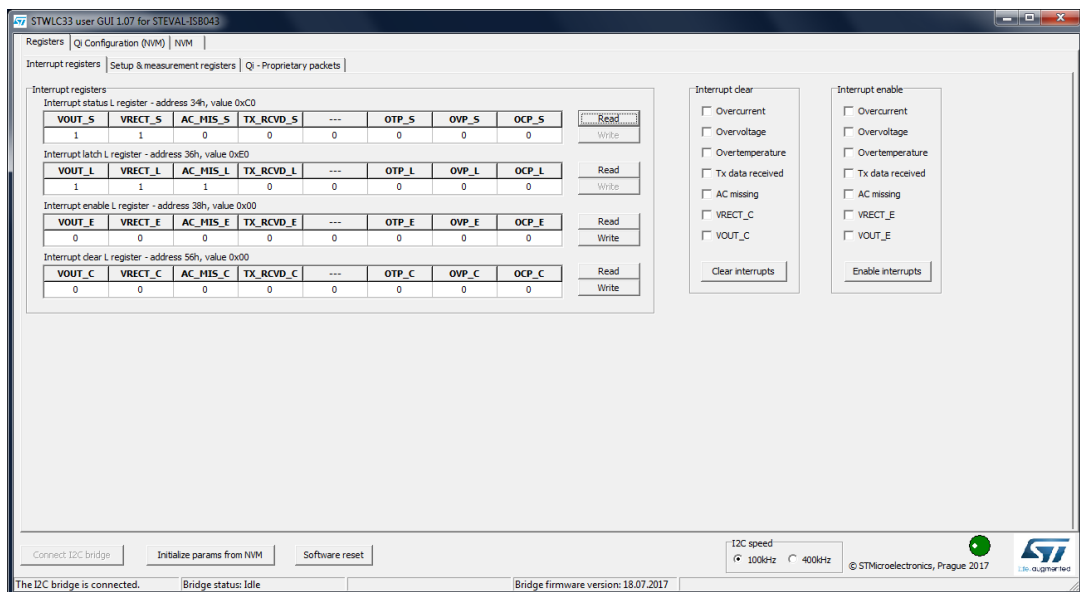

The **Setup and measurement registers** sub-tab (see [Figure 3. Setup and measurement registers sub-tab](#)) controls registers and measurement values.

**VOUT\_set** or **ILIM\_set** modifications are immediate.

The default values are loaded automatically from NVM after wireless operating standard detection.

*Important:* **Changing the output voltage must respect the overall system design (coil selection, transmitter types etc.).**

The **Power transfer** termination consists of two steps:

- writing the **EPT** register;
- writing 1 in the **S\_EPT bit in Com** register.

**AD conversion** results provide immediate VRECT and VOUT voltages and, during power transfer, die temperature and output current.

**RXID** and **PRMC\_ID** registers become active after wireless standard detection and provide an easy-to-read self-ID (either Qi ID or PMA ID).

**Figure 3. Setup and measurement registers sub-tab**

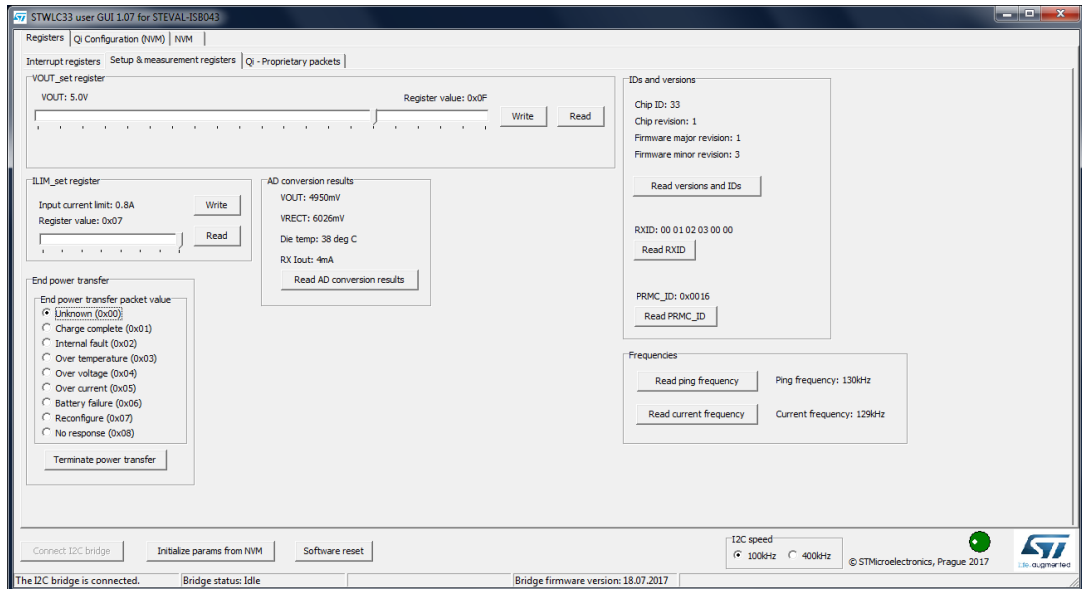

The **Qi – Proprietary packets** sub-tab allows sending any Qi packet and, in Qi 1.2 only, receive the response from the transmitter (both pattern type or data type responses are supported).

**Figure 4. Qi – Proprietary packets sub-tab**

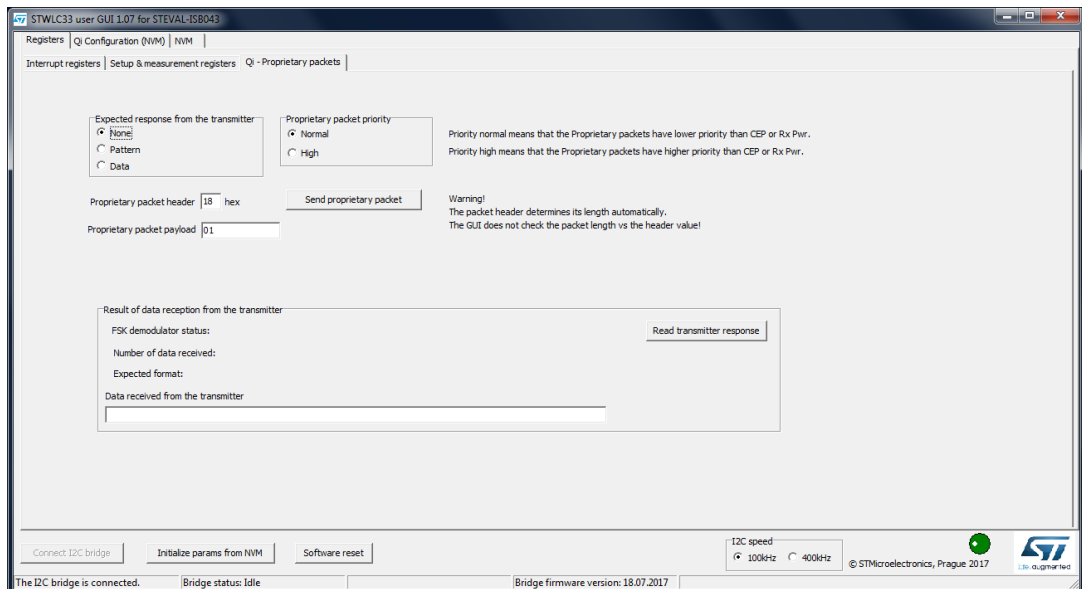

## 1.4 GUI: NVM configuration access

### 1.4.1 Qi NVM configuration

The **Qi configuration** tab contains manufacturer and device identifiers sent over the Qi protocol.

The tab contains also default values for the **VOUT voltage**, **Input current limit**, **OVP clamp threshold** and **Interrupt enable** registers.

**STWLC33** automatically terminates the power transfer if the load is below a certain threshold for a certain period of time. By default, this feature is eliminated by setting the lowest possible current and the longest possible time.

*Note:* **Qi specification does not require this feature.**

To maintain the Qi foreign object detection feature accurate, you must provide the correct values representing the coil parameters and the mechanical setup.

The evaluation kit contains components with the correct values to be used.

If, for example, the coil is replaced, FODs have to be recalculated and updated; the affected parameters are **FOD\_A**, **FOD\_B** and **FOD\_C**.

**Figure 5. GUI: Qi NVM configuration tab**

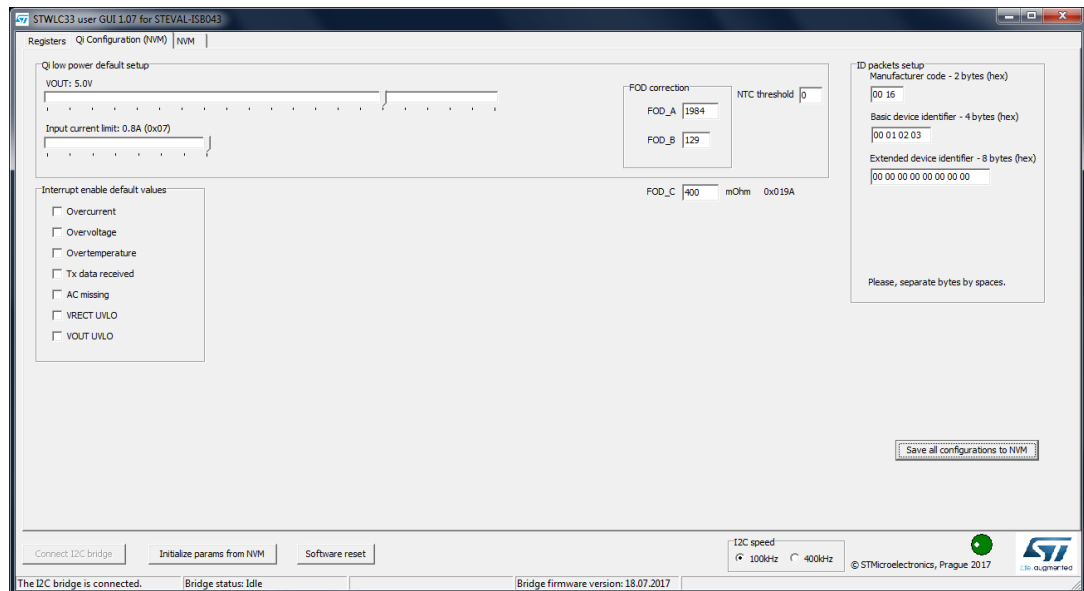

## 1.4.2 Generic load/save NVM access

The **NVM** tab allows the backup of the current NVM configuration into a file or loading a new one from a file.

Figure 6. GUI: NVM tab

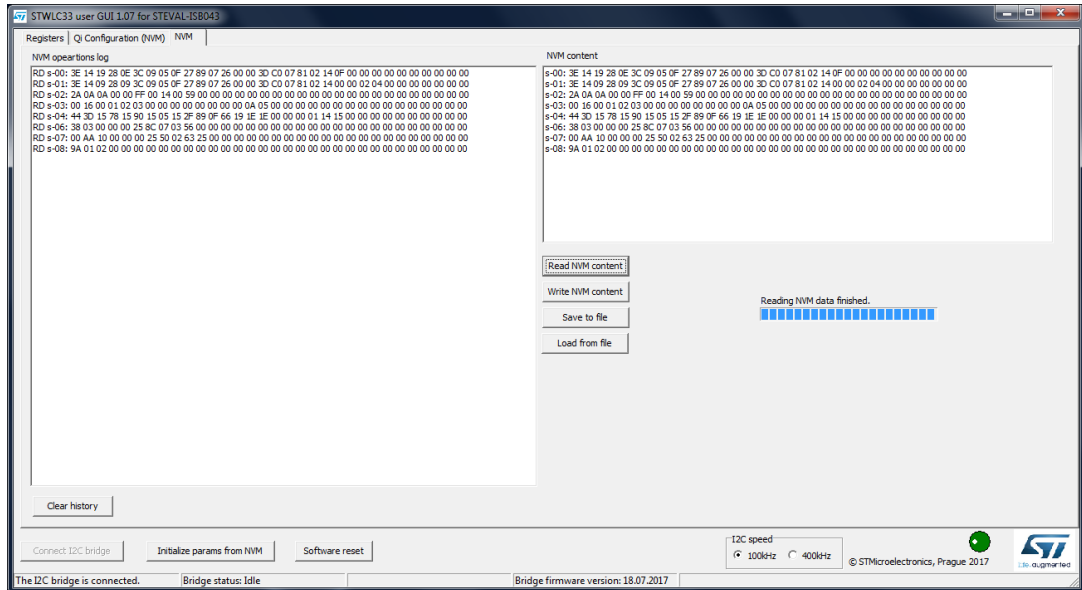

## 2 Qi compatibility

---

The STEVAL-ISB043V1 evaluation board wireless interface is fully compatible with Qi 1.2 (baseline power profile) digital protocol.

*Note: Due to the small-sized Rx coil, correct functionality with all Qi transmitters cannot be guaranteed.*

## 3 Configuration guidelines

---

### 3.1 Changing VOUT voltage: constraints

The power LDO supports the VOUT setting from 3.5 to 12.5 V; but, selecting VOUT properly is more complex and involves other aspects in the system.

The STEVAL-ISB043V1 evaluation board is tuned to work well only at 5 V VOUT voltage.

Using a different output voltage may require different Rx coil and input resonant circuit capacitors but it has to be considered case by case.

### 3.2 Input current limit

The power LDO is able to limit the output current. This limitation starts softly reducing the VOUT voltage even before reaching the limit.

### 3.3 Minimal load

All wireless systems are designed to transfer power. If power is not being transferred, it becomes hard to maintain Rx-to-Tx communication.

STWLC33 is equipped with a dummyload circuit that increases the load by consuming the power when no output load is present. Due to heat dissipation the dummy consumption is limited to tens of milliamps.

Even if this should be enough to maintain communication with most transmitters, it is recommended to always apply at least 100 mA.



## 4 Performance charts

The STEVAL-ISB043V1 evaluation board performance has been evaluated through the STEVAL-ISB042V1 evaluation board in Tx mode and by a standalone Qi 1.2 BPP certified power transmitter. The overall system efficiency is above 70%.

**Figure 7. STEVAL-ISB043V1 evaluation board performance: power transfer efficiency vs output power**

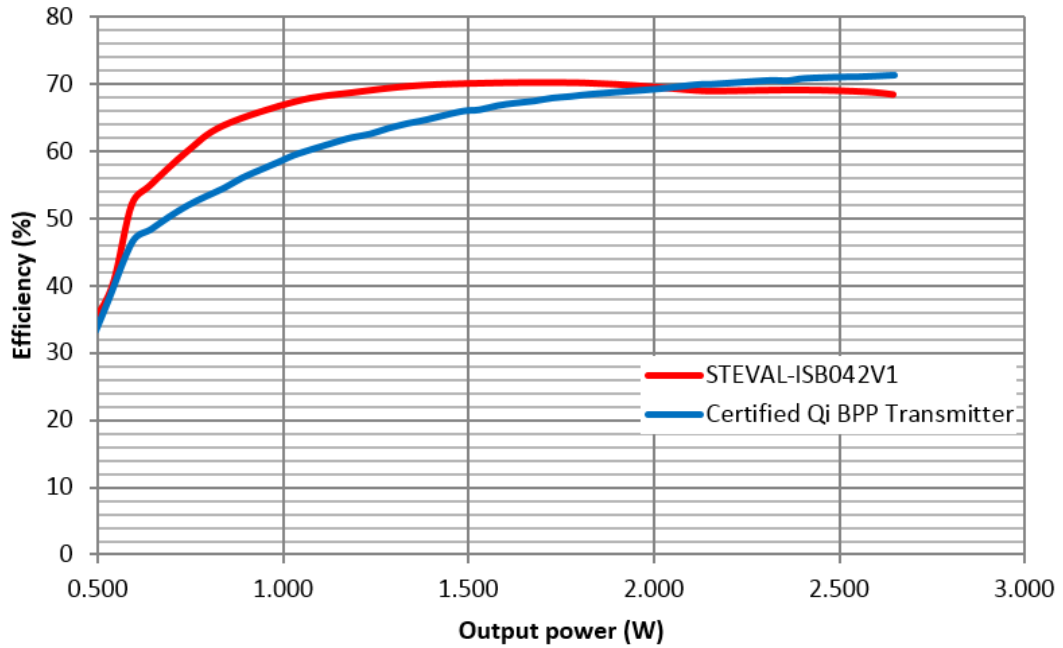

The output voltage regulation is less than 2% independent of the transmitter transition from no load to full load.

**Figure 8. STEVAL-ISB043V1 evaluation board performance: output voltage vs output power**

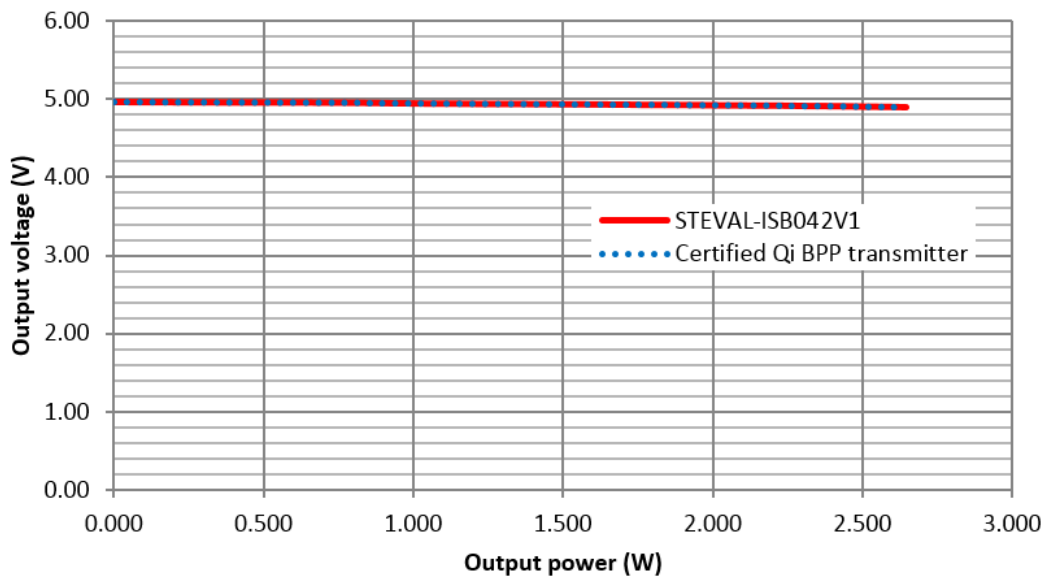

# 5 Schematic diagrams

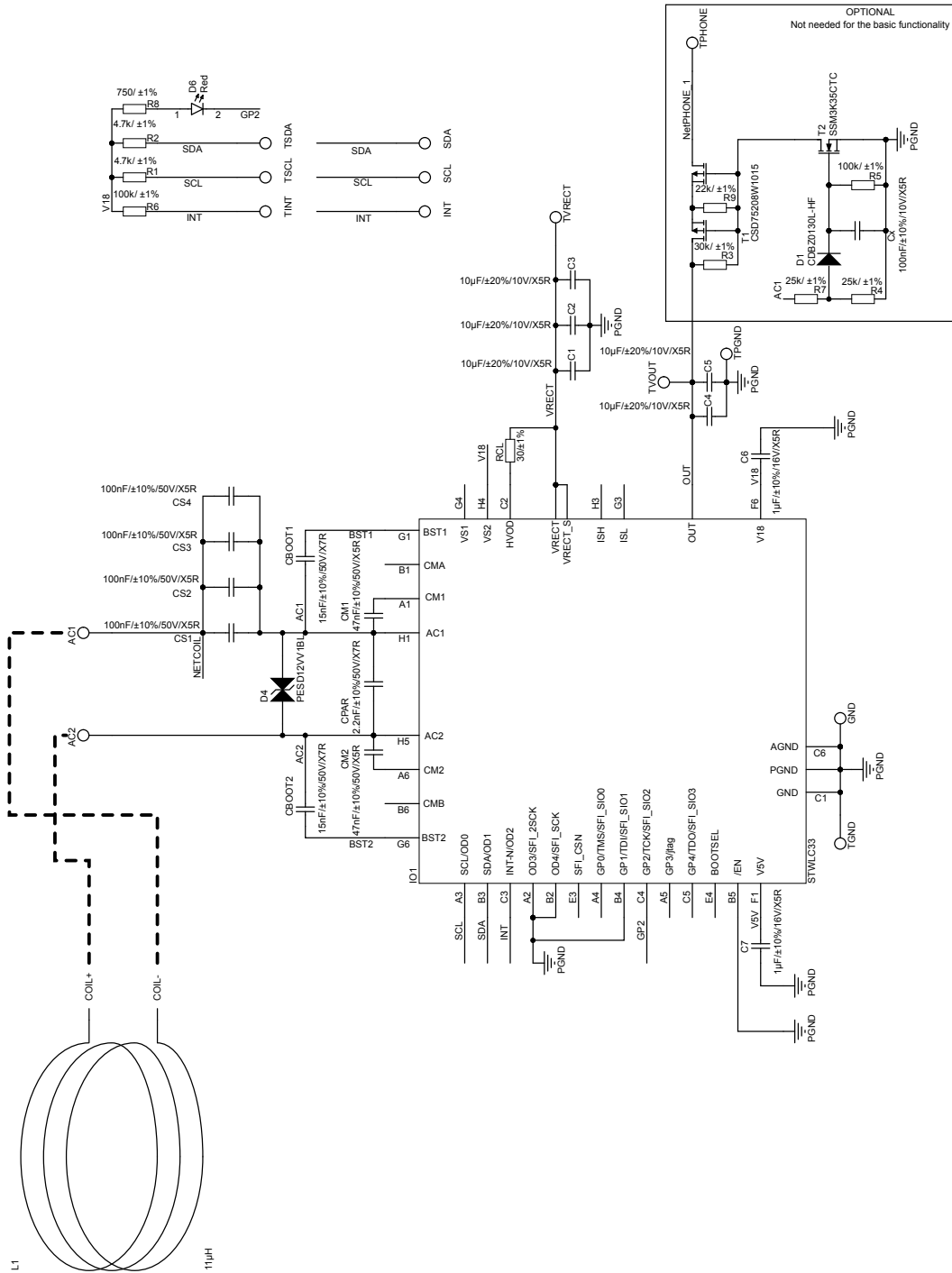
**Figure 9. STEVAL-ISB043V1 circuit schematic**

## 6 Bill of materials

**Table 1. STEVAL-ISB043V1 bill of materials**

Item	Q.ty	Ref.	Part/Value	Description	Manufacturer	Order code
1	5	C1, C2, C3, C4, C5	10 $\mu$ F 10 V X5R $\pm$ 20% CAP0402	Capacitors	Murata	GRM155R61A106ME11#
2	2	C6, C7	1 $\mu$ F 16 V X5R $\pm$ 10% CAP0402	Capacitors	Murata	GRM155R61E105KA12#
3	1	CBL1	100 mm length = 10 cm	Ribbon_3_red_black_FE-MALE	Any	Any
4	1	CBL2	100 mm length = 10 cm	Ribbon_2_red_black_MALE	Any	Any
5	2	CBOOT 1, CBOOT 2	15 nF 50 V X7R $\pm$ 10% CAP0402	Multilayer ceramic capacitors	Murata	GRM155R71H153KA12#
6	2	CM1, CM2	47 nF 50 V X5R $\pm$ 10% CAP0402	Multilayer ceramic capacitors	Murata	GRM155R61H473KE19#
7	1	CPAR	2.2 nF 50 V X7R $\pm$ 10% CAP0402	Multilayer ceramic capacitors	Murata	GRM155R71H222KA01#
8	3	CS1, CS2, CS3	100 nF 50 V X5R $\pm$ 10% CAP0402	Multilayer ceramic capacitors	Murata	GRM155R61H104KE19#
9	1	CS4		Multilayer ceramic capacitors	Any	Any
10	1	Cx	100 nF 10 V X5R $\pm$ 10% CAP0201	Capacitor	Murata	GRM033R61A104KE15
11	1	D1	CDBZ0130L-HF 30V D0201	Signal Schottky diode	Comchip	CDBZ0130L-HF
12	1	D4	PESD12VV1BL 12V SOD882	ESD protection diode	Nexperia	PESD12VV1BL
13	1	D6	Red LED0402	LED diode	Any	Any
14	1	IO1	STWLC33 CSP_9x6_400um WLC53 Octa	Multi Mode Qi/Airfuel inductive wireless power receiver with transmitter function	ST	<a href="#">STWLC33</a>
15	1	L1	11 $\mu$ H	Coil	Würth	760308101309
16	2	R1, R2	4.7 k, $\pm$ 1%, R0201	Resistors	Any	Any
17	1	R3		Not assembled		
18	2	R4, R7	25 k, $\pm$ 1%, R0201	Resistors	Any	Any
19	2	R5, R6	100 k, $\pm$ 1%, R0201	Resistors	Any	Any
20	1	R8	750, $\pm$ 1%, R0201	Resistor	Any	Any

Item	Q.ty	Ref.	Part/Value	Description	Manufacturer	Order code
21	1	R9	22 k, $\pm 1\%$ , R0201	Resistor	Any	Any
22	1	RCL	30, $\pm 1\%$ , R0603	Thick film resistor	Panasonic	ERJ-PA3F30R0V
23	1	S1	diameter 27mm, thickness 15mm	Plastic body	Any	Any
24	1	S2	diameter 27mm, thickness 1.3mm	Plastic spacer	Any	Any
25	1	T1	CSP 2x3 500 $\mu\text{m}$ pitch	Power MOSFET	Texas Instruments	CSD75208W1015
26	1	T2	CST3C	Small-Signal MOSFET	Toshiba	SSM3K35CTC,L3F

## 7 Board layout

Figure 10. STEVAL-ISB043V1: top silkscreen

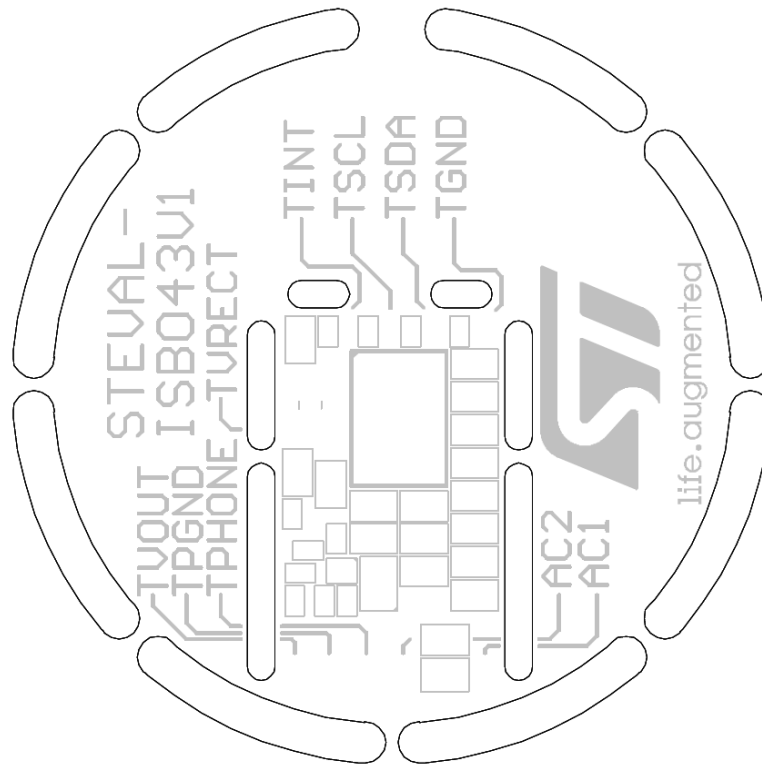

Figure 11. STEVAL-ISB043V1: copper layer 1

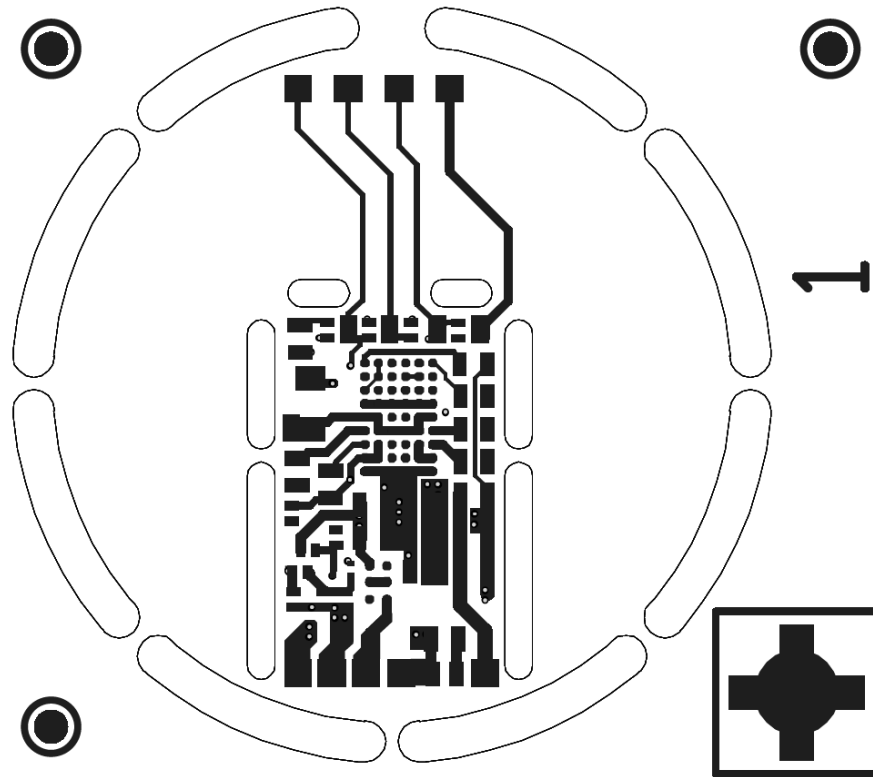

Figure 12. STEVAL-ISB043V1: copper layer 2

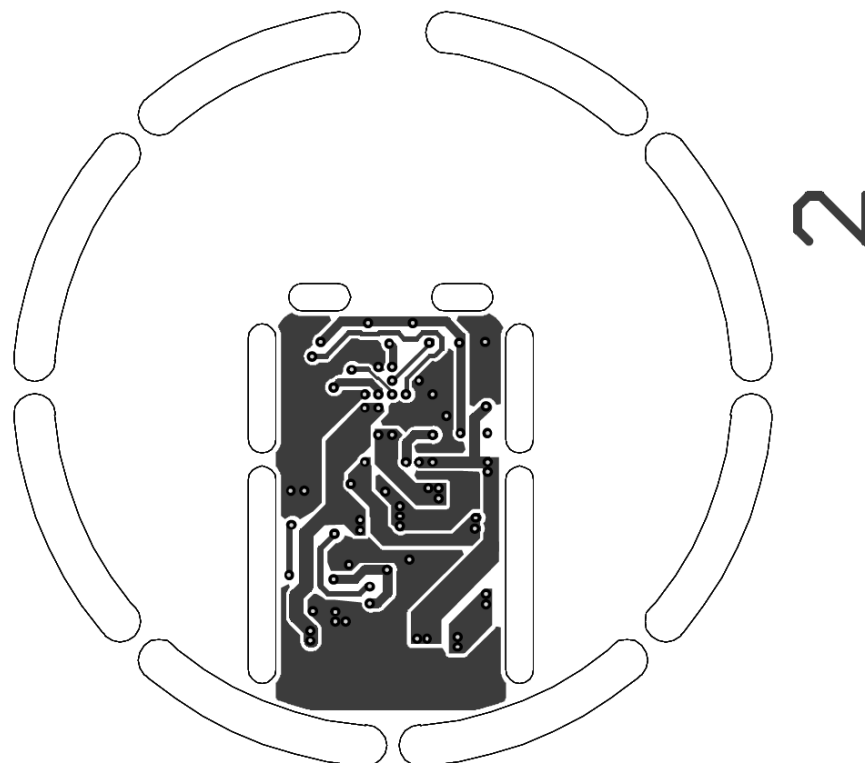

Figure 13. STEVAL-ISB043V1: copper layer 3

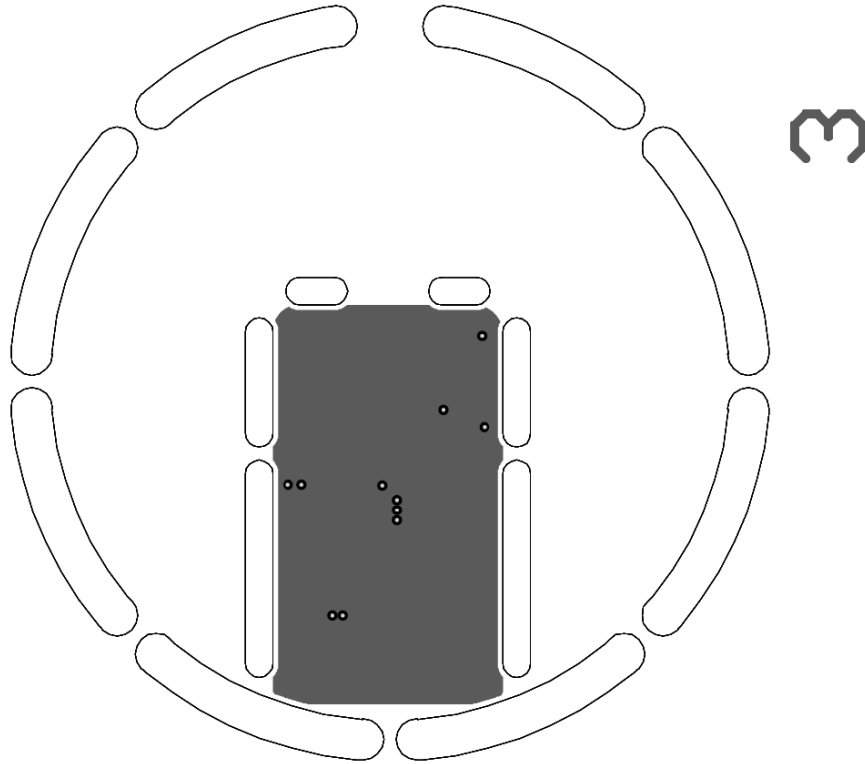
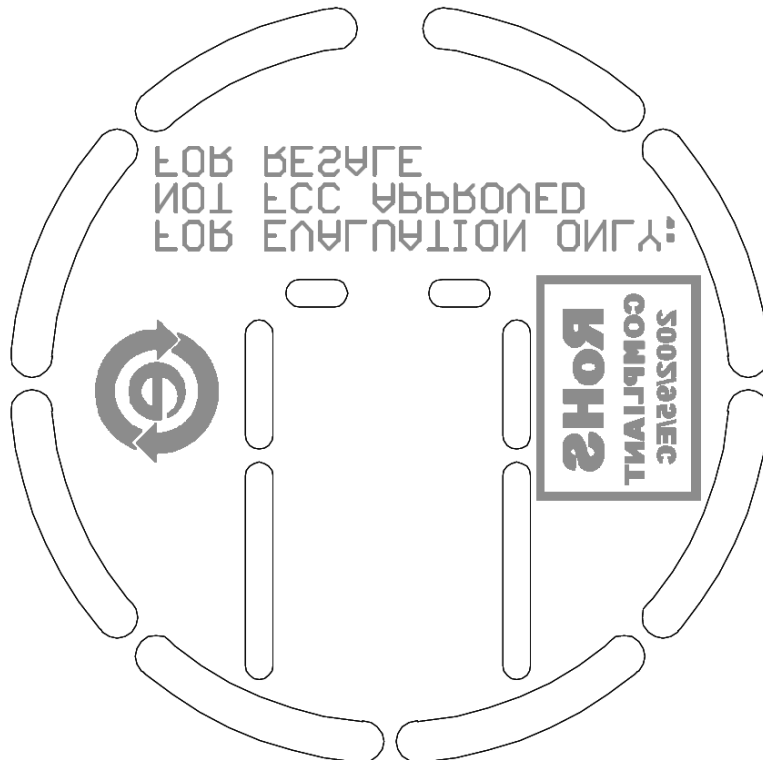

Figure 14. STEVAL-ISB043V1: bottom silkscreen







## 8 References

---

Freely available on [www.st.com](http://www.st.com):

1. STWLC33 datasheet.

## Revision history

**Table 2. Document revision history**

Date	Version	Changes
13-Dec-2017	1	Initial release.

## Contents

<b>1</b>	<b>Getting started.....</b>	<b>2</b>
1.1	Board overview.....	2
1.1.1	Board configuration and test points.....	2
1.2	STWLC33 NVM configuration.....	2
1.3	GUI: I <sup>2</sup> C register access.....	2
1.4	GUI: NVM configuration access.....	4
1.4.1	Qi NVM configuration.....	4
1.4.2	Generic load/save NVM access.....	5
<b>2</b>	<b>Qi compatibility.....</b>	<b>7</b>
<b>3</b>	<b>Configuration guidelines.....</b>	<b>8</b>
3.1	Changing VOUT voltage: constraints.....	8
3.2	Input current limit.....	8
3.3	Minimal load.....	8
<b>4</b>	<b>Performance charts.....</b>	<b>9</b>
<b>5</b>	<b>Schematic diagrams.....</b>	<b>10</b>
<b>6</b>	<b>Bill of materials.....</b>	<b>11</b>
<b>7</b>	<b>Board layout.....</b>	<b>13</b>
<b>8</b>	<b>References.....</b>	<b>17</b>
	Revision history.....	18
	Contents.....	19
	List of tables.....	20
	List of figures.....	21

## List of tables

<b>Table 1.</b>	STEVAL-ISB043V1 bill of materials .....	11
<b>Table 2.</b>	Document revision history .....	18

## List of figures

<b>Figure 1.</b>	STEVAL-ISB043V1 evaluation board . . . . .	1
<b>Figure 2.</b>	Interrupt registers sub-tab . . . . .	3
<b>Figure 3.</b>	Setup and measurement registers sub-tab . . . . .	4
<b>Figure 4.</b>	Qi – Proprietary packets sub-tab . . . . .	4
<b>Figure 5.</b>	GUI: Qi NVM configuration tab . . . . .	5
<b>Figure 6.</b>	GUI: NVM tab . . . . .	6
<b>Figure 7.</b>	STEVAL-ISB043V1 evaluation board performance: power transfer efficiency vs output power . . . . .	9
<b>Figure 8.</b>	STEVAL-ISB043V1 evaluation board performance: output voltage vs output power . . . . .	9
<b>Figure 9.</b>	STEVAL-ISB043V1 circuit schematic . . . . .	10
<b>Figure 10.</b>	STEVAL-ISB043V1: top silkscreen . . . . .	13
<b>Figure 11.</b>	STEVAL-ISB043V1: copper layer 1 . . . . .	14
<b>Figure 12.</b>	STEVAL-ISB043V1: copper layer 2 . . . . .	14
<b>Figure 13.</b>	STEVAL-ISB043V1: copper layer 3 . . . . .	15
<b>Figure 14.</b>	STEVAL-ISB043V1: bottom silkscreen . . . . .	15
<b>Figure 15.</b>	STEVAL-ISB043V1: assembly drawing . . . . .	16

**IMPORTANT NOTICE – PLEASE READ CAREFULLY**

STMicroelectronics NV and its subsidiaries (“ST”) reserve the right to make changes, corrections, enhancements, modifications, and improvements to ST products and/or to this document at any time without notice. Purchasers should obtain the latest relevant information on ST products before placing orders. ST products are sold pursuant to ST’s terms and conditions of sale in place at the time of order acknowledgement.

Purchasers are solely responsible for the choice, selection, and use of ST products and ST assumes no liability for application assistance or the design of Purchasers’ products.

No license, express or implied, to any intellectual property right is granted by ST herein.

Resale of ST products with provisions different from the information set forth herein shall void any warranty granted by ST for such product.

ST and the ST logo are trademarks of ST. All other product or service names are the property of their respective owners.

Information in this document supersedes and replaces information previously supplied in any prior versions of this document.

© 2017 STMicroelectronics – All rights reserved