

GlobTek, Inc. www.globtek.com 186 Veterans Drive, Northvale, NJ 07647 Tel. (201) 784-1000 Fax (201) 784-0111	Drawing Title: GTM961200P12024-T3, ITE / Medical Power Supply, Efficiency Level: VI, Case Color/Style: GlobTek Black, Desktop/External, Regulated Switchmode AC-DC Power Supply AC Adaptor, Input Rating: 100-240V~, 50-60 Hz, IEC 60320/C14 , Output Rating: 120W, 24V@5A, Output Configuration: 1200 mm, 16/2 Cond, UL 2468, Female Barrel 5.5*2.1*11mm WITH internal Spring Clip and Locking Notch or Equal, Ferrite: Core Size: 14.2*28.5*8.2, GlobTek Black, GT Cord # C11224, Pin Out: Center Positive (+V), Blades/Input Cord: Not Applicable, Approvals: RCM CCC EAC cETLus cETLus cETLus ETL S-Mark CB CB CB ETL CB VCCI CB S-Mark WEEE Ukraine RoHS PSE Level VI China RoHS CE Class I PSE PSE PSE	
	Model No. GTM961200P12024-T3	
	Part No./Ordering No. TR9CI5000CCP-IM(R6B)	Rev D

## REVISION HISTORY

REV	DESCRIPTION	SUB	DATE	APPROVED
D	Add CCC,EAC,Update RoHS 2 to RoHS, Ukraine mark, "Conforms", serial number Update Grounding Configuration on the label	QA	07/28/2018	QA
C	Update wire gauge from 14 AWG to 16 AWG	rchiu	08/02/2017	QA
B	update link to online documents, add grounding configuration	dhock	07/10/2017	QA
A	Initial Release	jwarn	05/02/2017	QA

In Addition to GlobTek Inc.'s renewed ISO9001:2008 - Quality Management System Certification, GlobTek Inc. is now certified to:

ISO13485:2003 - Medical Devices Quality Management System Certification

ISO14001:2004 - Environmental Management System Certification

ISO Certificates are available online at <http://www.globtek.com/iso-certificates/>

### Customer Approval of Specification:

Please approve, sign and send back to GlobTek so we can complete order processing.

A delay in receipt of this form will delay delivery schedule.

Company Name:

Customer P/N:

Quote Number:

Date:

Authorized Representative Name:

Authorized Representative Signature:

The acceptance of this specification and use of the product described in this document indicates the acceptance and binding of the customer to Globtek terms and conditions, which supersede all other agreements, terms, and conditions (<http://en.globtek.com/terms-and-conditions/>).

### Footnote:

GlobTek Inc. will not be liable for the safety and performance of these power supplies if unauthorized access and repair occurs. End user should consult applicable UL, CSA or EN standards for proper installation instruction.

### Limitation of Use:

GlobTek product are not authorized for use as mission critical components in life support hazardous environment, nuclear or aircraft applications without prior written approval from the CEO of GlobTek Inc.

Contents of this document are subject to change without prior notice.

GTM961200P12024-T3, 120W, 24V@5A, Desktop/External, Regulated Switchmode AC-DC Power Supply AC Adaptor

PROPRIETARY INFORMATION

PROPRIETARY OF GLOBTEK, INC. ANY REPRODUCTION, DISCLOSURE OR USE OF THIS DRAWING, IN WHOLE OR IN PART, IS HEREBY PROHIBITED EXCEPT AS SPECIFIED IN WRITING BY GLOBTEK, INC.

quest /08/20/2018 7:42:43 AM

GloTek, Inc. www.globtek.com 186 Veterans Drive, Northvale, NJ 07647 Tel. (201) 784-1000 Fax (201) 784-0111	Drawing Title: GTM961200P12024-T3, ITE / Medical Power Supply, Efficiency Level: VI, Case Color/Style: GlobTek Black, Desktop/External, Regulated Switchmode AC-DC Power Supply AC Adaptor, Input Rating: 100-240V~, 50-60 Hz, IEC 60320/C14 , Output Rating: 120W, 24V@5A, Output Configuration: 1200 mm, 16/2 Cond, UL 2468, Female Barrel 5.5*2.1*11mm WITH internal Spring Clip and Locking Notch or Equal, Ferrite: Core Size: 14.2*28.5*8.2, GlobTek Black, GT Cord # C11224, Pin Out: Center Positive (+V), Blades/Input Cord: Not Applicable, Approvals: RCM CCC EAC cETLus cETLus cETLus ETL S-Mark CB CB CB ETL CB VCCI CB S-Mark WEEE Ukraine RoHS PSE Level VI China RoHS CE Class I PSE PSE PSE	
	Model No. GTM961200P12024-T3	
	Part No./Ordering No. TR9CI5000CCP-IM(R6B)	Rev D

**POWER SUPPLY INFORMATION**

TYPE: Desktop/External  
TECHNOLOGY: Regulated Switchmode AC-DC Power Supply AC Adaptor  
CASE COLOR: GlobTek Black  
NAMEPLATE RATED INPUT: 100-240V~, 50-60 Hz, 1.5 A  
INPUT CONFIG: IEC 60320/C14  
WATTS: 120.0  
VOLTS OUT: 24  
CURRENT OUT (Amps): 5  
BLADE/CORD INCLUDED: N/A:  
BLADE/CORD INSTALLED: N/A:  
GROUNDING CONFIGURATION (F2) Isolated Functional Earth for GTM96 series, Improved EMC  
EFFICIENCY LEVEL: VI  
OUTPUT CONFIGURATION 1200 mm, 16/2 Cond, UL 2468, Female Barrel 5.5\*2.1\*11mm WITH internal Spring Clip and Locking Notch or Equal, Ferrite: Core Size: 14.2\*28.5\*8.2, GlobTek Black, GT Cord # C11224  
CONNECTOR PIN OUT: Center Positive (+V)  
LABEL SPECS: Standard GT,L-1186  
PACK SPEC: Standard DT, Cellular packaging

Notes/Modifications/Customizations (notes in this section supersede the values shown in the standard spec):

DIMENSIONS ARE IN MM UNLESS SPECIFIED OTHERWISE.

GlobTek, Inc. www.globtek.com 186 Veterans Drive, Northvale, NJ 07647 Tel. (201) 784-1000 Fax (201) 784-0111	Drawing Title: GTM961200P12024-T3, ITE / Medical Power Supply, Efficiency Level: VI, Case Color/Style: GlobTek Black, Desktop/External, Regulated Switchmode AC-DC Power Supply AC Adaptor, Input Rating: 100-240V~, 50-60 Hz, IEC 60320/C14 , Output Rating: 120W, 24V@5A, Output Configuration: 1200 mm, 16/2 Cond, UL 2468, Female Barrel 5.5*2.1*11mm WITH internal Spring Clip and Locking Notch or Equal, Ferrite: Core Size: 14.2*28.5*8.2, GlobTek Black, GT Cord # C11224, Pin Out: Center Positive (+V), Blades/Input Cord: Not Applicable, Approvals: RCM CCC EAC cETLus cETLus cETLus ETL S-Mark CB CB CB ETL CB VCCI CB S-Mark WEEE Ukraine RoHS PSE Level VI China RoHS CE Class I PSE PSE PSE	
	Model No. GTM961200P12024-T3	
	Part No./Ordering No. TR9CI5000CCP-IM(R6B)	Rev D

## ELECTRICAL SPECIFICATIONS

### A) ELECTRICAL SPECIFICATIONS:

01. Input Voltage: Specified 90-264 Vac, Nameplate rated: 100-240Vac
  - 90-264Vac range @ 100% of rated load current
  - 85-264 Vac range @ 90% of rated load current
  - 90-370 VDC range @ 100% of rated load current
02. Input Frequency: Specified 47-63 Hz, Nameplate rated 50/60Hz
03. Power Factor: 0.90 minimum @ 230Vac, 0.97 minimum @ 115Vac
04. Output Regulation: +/- 4% measured at the output connector
05. Line Voltage Regulation: +/- 0.5% typical measured at full load
06. Green Power On Indicator LED
07. Output Ripple (Vp-p): 1% or 200 mV whichever is greater, measured at 20 MHz bandwidth with 0.1 uf ceramic capacitor in parallel with a low impedance 47 uf electrolytic capacitor connected at the end of the output connector at nominal line
08. Turn-ON/OFF Overshoot: 8% maximum, 1 mS typical recovery time for 25% to 50% step load
09. Turn-ON Delay: 1 second typical
10. Hold-Up Time: 20 mS minimum
11. Inrush Current: 30A maximum at 115Vac input and 60A maximum at 230 Vac input
12. Switching Frequency: Varies from 25KHz to 125KHz
13. Efficiency: Compliant with Efficiency Level VI standard and 230 CoC Tier 2 Limits
14. No Load Standby Power: <0.15 W @ 230Vac

### B) PROTECTION

01. Input Protection: Input line fusing and 300Vac rated MOV
02. Short Circuit/ Overload: Electronically Protected unit will auto recover upon removal of fault
  - Output Current Limit: Current limited to less than 170W / Vnom and 13A
  - (Vnom = nominal rated output voltage)
03. Over-Temperature : Latching Electronic Overtemperature protection. Cycle AC OFF to reset.
04. Output Over-Voltage: 110% to 135% of nominal output voltage under full load condition, and less than 60V max. Latching protection, cycle AC OFF to reset.

### C) SAFETY

01. Dielectric Withstand Voltage: 4000Vac or 5656Vdc from input to output, On Class I models, 3000Vac or 4242Vdc from input to earth
02. Earth Leakage Current: Class I models < 300uA, N/A for Class II models
03. Touch Current: Class I models < 20uA, Class II models < 70uA
04. [Output Isolation Options:](#)
  - a) C8 or C18 Inlet, Class II
  - b) C6 or C14 Inlet, Class II FE, Output Isolated from Earth contact
  - c) C6 or C14 Inlet, Class I, Output negative directly attached to Earth contact
05. Earth Continuity Test: < 0.1 Ohm between Earth Pin at AC input and PCB termination point (Class I models only)
06. Means of Protection: 2 x MOPP
07. Primary to Secondary Bridging Capacitance: Two IEC60384-14 certified Y1 type capacitors in series
08. Compliant Standards: See listings at end of this drawing for specifics

### D) EMC

- EN 60601-1-2, 4<sup>th</sup> edition  
Emissions, per EN 55032, EN 61000-6-3, EN 61000-6-4  
Conducted Emissions: Class B, FCC Part 15, Class B  
Radiated Emissions: Class B, FCC Part 15, Class B  
Line Frequency Harmonics EN61000-3-2, Class A  
Voltage Fluctuations/Flicker EN61000-3-3
- Immunity, per EN 55024, EN 61000-6-1, EN 61000-6-2  
Static Discharge Immunity EN61000-4-2, 10kV Contact Discharge, 18kV air discharge  
Radiated RF Immunity EN61000-4-3, 10V/m 80-1000MHz, 3V/m 1-2.7GHz, 80% 1KHz AM.  
EFT/Burst Immunity EN61000-4-4, 4kV/100kHz.  
Line Surge Immunity EN61000-4-5, 2kV differential, 4kV common-mode  
Conducted RF Immunity EN61000-4-6, 3Vrms, 80% 1KHz AM  
Power Frequency Magnetic Field Immunity EN61000-4-8, 3A/m  
Voltage Dip Immunity EN61000-4-11, Criteria

#### PROPRIETARY INFORMATION

PROPRIETARY OF GLOBTEK, INC. ANY REPRODUCTION, DISCLOSURE OR USE OF THIS DRAWING, IN WHOLE OR IN PART, IS HEREBY PROHIBITED EXCEPT AS SPECIFIED IN WRITING BY GLOBTEK, INC.

GlobTek, Inc. www.globtek.com 186 Veterans Drive, Northvale, NJ 07647 Tel. (201) 784-1000 Fax (201) 784-0111	Drawing Title: GTM961200P12024-T3, ITE / Medical Power Supply, Efficiency Level: VI, Case Color/Style: GlobTek Black, Desktop/External, Regulated Switchmode AC-DC Power Supply AC Adaptor, Input Rating: 100-240V~, 50-60 Hz, IEC 60320/C14 , Output Rating: 120W, 24V@5A, Output Configuration: 1200 mm, 16/2 Cond, UL 2468, Female Barrel 5.5*2.1*11mm WITH internal Spring Clip and Locking Notch or Equal, Ferrite: Core Size: 14.2*28.5*8.2, GlobTek Black, GT Cord # C11224, Pin Out: Center Positive (+V), Blades/Input Cord: Not Applicable, Approvals: RCM CCC EAC cETLus cETLus cETLus ETL S-Mark CB CB CB ETL CB VCCI CB S-Mark WEEE Ukraine RoHS PSE Level VI China RoHS CE Class I PSE PSE PSE	
	Model No. GTM961200P12024-T3	
	Part No./Ordering No. TR9CI5000CCP-IM(R6B)	Rev D

**E) OTHER:**

- 01. MTBF: 500,000 Hours @ 40°C ambient temperature, Full Load
- 02. Operating Temperature:  
 GTM961200P Family: -20°C to 40°C ambient temperature with full load  
 Regarding Operating Temperature,  
 a- See below derating table for output power capability at alternate temperature  
 b- Extended low end temperature range available as custom option
- 03. Humidity: 0% to 95% relative humidity, non-condensing
- 04. Storage Temperature: -30°C to 80°C
- 05. Cooling: Convection
- 06. ROHS: Compliant with latest regulations, see approvals section below
- 07. Operational Altitude: 5000M

**F) ENCLOSURE**

- 01. Housing: High impact plastic, 94V0 polycarbonate, non-vented
- 02. Size: 149.4 x 62.6 x 33.5 +/-1.0 mm
- 03. Markings: Label or Laser printed
- 04. AC Input mechanical options: Desktop C6, C8, C14 or C18 IEC Inlet.

**G) SPECIAL OPTIONS**

- 01. Custom Cordsets, various cordage types, and connector types
- 02. Custom Markings
- 03. Short term Output Surge Capability
- 04. Reduced Leakage Current version, medical CF leakage current compliance
- 05. Tightened output voltage tolerance
- 06. Reduced Output Ripple Level
- 07. LED Lighting, Class C Line Harmonics per 61000-3-2, from 85W to 120W output
- 08. Reduced output power marking/rating
- 09. High Rel PCB laminate with Plated through Holes for IPC610 Class 2 Compliance
- 10. Low Temperature operation, down to -40°C
- 11. Special Housing Colors and Cordset Colors

**H) OUTPUT CONNECTORS**

Several output connector options are available with various output current ratings. GlobTek can supply 10A rated 2.1mm and 2.5mm style DC Power Jacks, to complement our 10A output rated 2.1mm and 2.5mm DC power plugs used on our output cordsets.

2.1mm PCB DC Power Jack ordering code: **JACK-C-PC-10A-RA(R)**

2.5mm PCB DC Power Jack ordering code: **JACK-L-PC-10A-RA(R)**

GlobTek, Inc.  
 www.globtek.com  
 186 Veterans Drive,  
 Northvale, NJ 07647  
 Tel. (201) 784-1000  
 Fax (201) 784-0111

Drawing Title: GTM961200P12024-T3, ITE / Medical Power Supply, Efficiency Level: VI, Case Color/Style: GlobTek Black, Desktop/External, Regulated Switchmode AC-DC Power Supply AC Adaptor, Input Rating: 100-240V~, 50-60 Hz, IEC 60320/C14, Output Rating: 120W, 24V@5A, Output Configuration: 1200 mm, 16/2 Cond, UL 2468, Female Barrel 5.5\*2.1\*11mm WITH internal Spring Clip and Locking Notch or Equal, Ferrite: Core Size: 14.2\*28.5\*8.2, GlobTek Black, GT Cord # C11224, Pin Out: Center Positive (+V), Blades/Input Cord: Not Applicable, Approvals: RCM CCC EAC cETLus cETLus cETLus ETL S-Mark CB CB CB ETL CB VCCI CB S-Mark WEEE Ukraine RoHS PSE Level VI China RoHS CE Class I PSE PSE PSE

Model No. GTM961200P12024-T3

Part No./Ordering No. TR9CI5000CCP-IM(R6B)

Rev D

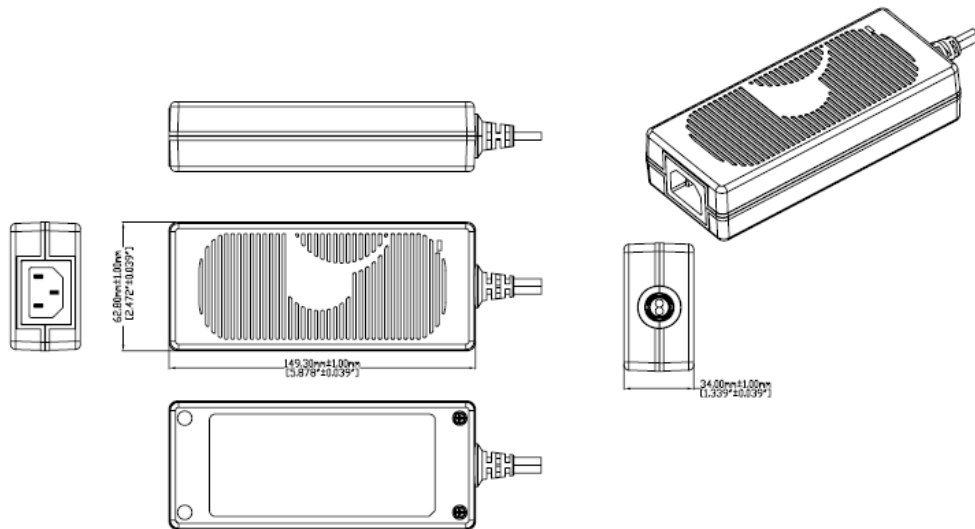

DERATING CURVE

TYPICAL EXTERNAL POWER SUPPLY DERATING CURVE

(FOR EFFICIENCY LEVEL V AND EFFICIENCY LEVEL VI PRODUCTS)

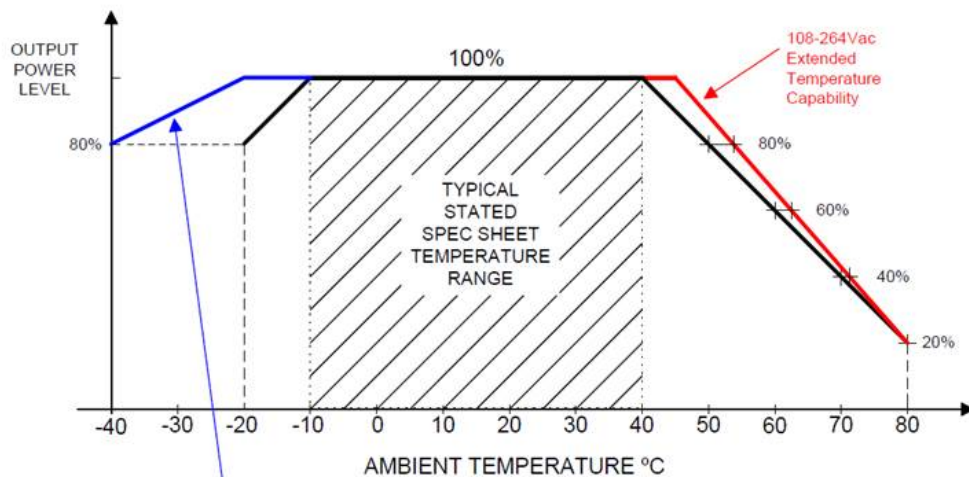

Blue Line represents special/optional Low Temperature, High Performance Construction

GlobTek, Inc.  
www.globtek.com  
186 Veterans Drive,  
Northvale, NJ 07647  
Tel. (201) 784-1000  
Fax (201) 784-0111

Drawing Title: GTM961200P12024-T3, ITE / Medical Power Supply, Efficiency Level: VI, Case Color/Style: GlobTek Black, Desktop/External, Regulated Switchmode AC-DC Power Supply AC Adaptor, Input Rating: 100-240V~, 50-60 Hz, IEC 60320/C14 , Output Rating: 120W, 24V@5A, Output Configuration: 1200 mm, 16/2 Cond, UL 2468, Female Barrel 5.5\*2.1\*11mm WITH internal Spring Clip and Locking Notch or Equal, Ferrite: Core Size: 14.2\*28.5\*8.2, GlobTek Black, GT Cord # C11224, Pin Out: Center Positive (+V), Blades/Input Cord: Not Applicable, Approvals: RCM CCC EAC cETLus cETLus cETLus ETL S-Mark CB CB CB ETL CB VCCI CB S-Mark WEEE Ukraine RoHS PSE Level VI China RoHS CE Class I PSE PSE PSE

Model No. GTM961200P12024-T3

Part No./Ordering No. TR9CI5000CCP-IM(R6B)

Rev D

## INPUT CONFIGURATION

Grounding Configuration:  
Blades/Cord Included: N/A:

Blades/Cord Installed: N/A:

IEC 60320/C14 AC Inlet Connector, Class I, Earth Ground

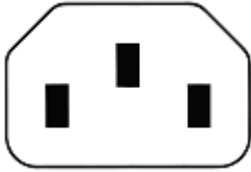

Mates with IEC 60320/C13 Plug

Optional Locking IEC60320 Receptacle and cord option available on some models by request.:

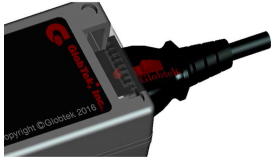

### [Standard International IEC 320/C13 Cordsets](#)

Below are standard cordsets which are "not included" (unless stated above); these can be purchased separately or packaged with the power supply. Contact your Sales Engineer if the style required is not shown below. Many more available in different lengths, colors or cable material.

## Stock Power Supply Cords

Part Number/ Link	Country	Plug	Termination	Length (mm)	(Ft)
3 Conductors (Grounded) IEC 320/C13					
<a href="#">3021457F701(R)</a>	N. American	NEMA 5-15P	IEC 320/C13	2150	7
<a href="#">1191068F0701(R)</a>	N. American	NEMA 5-15P Hospital	IEC 320/C13	2459	8
<a href="#">2194272M5701-T(R)</a>	Argentina	IRAM 2073	IEC 320/C13	2500	8
<a href="#">5502022M5701A(R)</a>	Australian	AS3112 / 3 PRONG	IEC 320/C13	2500	8
<a href="#">204B4272M5701(R)</a>	Brazil	BRAZILIAN; WS-002	IEC 320/C13	2500	8

### PROPRIETARY INFORMATION

PROPRIETARY OF GLOBTEK, INC. ANY REPRODUCTION, DISCLOSURE OR USE OF THIS DRAWING, IN WHOLE OR IN PART, IS HEREBY PROHIBITED EXCEPT AS SPECIFIED IN WRITING BY GLOBTEK, INC.

quest /08/20/2018 7:42:43 AM

GlobTek, Inc. www.globtek.com 186 Veterans Drive, Northvale, NJ 07647 Tel. (201) 784-1000 Fax (201) 784-0111	Drawing Title: GTM961200P12024-T3, ITE / Medical Power Supply, Efficiency Level: VI, Case Color/Style: GlobTek Black, Desktop/External, Regulated Switchmode AC-DC Power Supply AC Adaptor, Input Rating: 100-240V~, 50-60 Hz, IEC 60320/C14 , Output Rating: 120W, 24V@5A, Output Configuration: 1200 mm, 16/2 Cond, UL 2468, Female Barrel 5.5*2.1*11mm WITH internal Spring Clip and Locking Notch or Equal, Ferrite: Core Size: 14.2*28.5*8.2, GlobTek Black, GT Cord # C11224, Pin Out: Center Positive (+V), Blades/Input Cord: Not Applicable, Approvals: RCM CCC EAC cETLus cETLus cETLus ETL S-Mark CB CB CB ETL CB VCCI CB S-Mark WEEE Ukraine RoHS PSE Level VI China RoHS CE Class I PSE PSE PSE	
	Model No. GTM961200P12024-T3	
	Part No./Ordering No. TR9CI5000CCP-IM(R6B)	Rev D

<a href="#">6023602M5701(R)</a>	China	CCC GR2099	IEC 320/C13	2500	8
<a href="#">G8014272M5701(R)</a>	Danish	AFSNIT SECTION 107-2-D1	IEC 320/C13	2500	8
<a href="#">23144272M5701-T(R)</a>	Europe	CEE 7/7	IEC 320/C13	2500	8
2084272M5701(R)	India	India IS 1293 (also known as IA16A3 or BS546)	IEC 320/C13	2500	8
<a href="#">377C4272M5701(R)</a>	Israel	ISL 377C	IEC 320/C13	2500	8
<a href="#">23024272M5701(R)</a>	Italy	CEI 23-16/VII	IEC 320/C13	2500	8
<a href="#">3003339F701(R)</a> [3x1.25mm2] <a href="#">3003068F2701-HK(R)</a> [3 x 2.0mm2]	Japan	JIS 8303 / 3 PINS	IEC 320/C13	2500	8
<a href="#">2313K3432M5701(R)</a>	Korea	KS C 8305	IEC 320/C13	2500	8
23144272M5701-T(R) [Same as Europe Above]	Russia	GOST 7396	IEC 320/C13	2500	8
<a href="#">2084272M5701(R)</a>	S. Africa	S. African	IEC 320/C13	2500	8
<a href="#">23214272M5701(R)</a>	Switzerland	SEV 1011 ( EL 203)	IEC 320/C13	2500	8
<a href="#">3003322M5701(R)</a>	Taiwan	BSMI	IEC 320/C13	2500	8
<a href="#">PZ0800100-2M5BK13H(R)</a>	UK	BS 1363A	IEC 320/C13	2500	8
<a href="#">7055002M5701A(R)</a>	International	IEC 320 C14-C13	IEC 320/C13	2500	8

GlobTek, Inc.  
 www.globtek.com  
 186 Veterans Drive,  
 Northvale, NJ 07647  
 Tel. (201) 784-1000  
 Fax (201) 784-0111

Drawing Title: GTM961200P12024-T3, ITE / Medical Power Supply, Efficiency Level: VI, Case Color/Style: GlobTek Black, Desktop/External, Regulated Switchmode AC-DC Power Supply AC Adaptor, Input Rating: 100-240V~, 50-60 Hz, IEC 60320/C14 , Output Rating: 120W, 24V@5A, Output Configuration: 1200 mm, 16/2 Cond, UL 2468, Female Barrel 5.5\*2.1\*11mm WITH internal Spring Clip and Locking Notch or Equal, Ferrite: Core Size: 14.2\*28.5\*8.2, GlobTek Black, GT Cord # C11224, Pin Out: Center Positive (+V), Blades/Input Cord: Not Applicable, Approvals: RCM CCC EAC cETLus cETLus cETLus ETL S-Mark CB CB CB ETL CB VCCI CB S-Mark WEEE Ukraine RoHS PSE Level VI China RoHS CE Class I PSE PSE PSE

Model No. GTM961200P12024-T3

Part No./Ordering No. TR9CI5000CCP-IM(R6B)

Rev D

**OUTPUT CORD AND CONNECTOR: C1S/C11224**

ACTUAL CONNECTORS, OVERMOLDS, FERRITES MAY VARY SLIGHTLY FROM THE PICTURE BELOW

CABLE TYPE	UL 2468
CABLE LENGTH (mm)	1200
CABLE TOLERANCE (mm)	±100
WIRE GAUGE (AWG)	16
CONDUCTORS	2
HANK DIMENSION (mm)	95 ± 10
CABLE / CONNECTOR OVERMOLD COLOR	GlobTek Black
FERRITE TYPE / DIMENSION	Core Size: 14.2*28.5*8.2
FERRITE # OF TURNS ( <a href="#">Definition</a> )	2 Pass thru core (1 turns)
FERRITE DIMENSION FROM STRAIN RELIEF	50 ± 10
FERRITE DIMENSION FROM PLUG	N/A
PLUG TYPE	Female Barrel 5.5*2.1*11mm WITH internal Spring Clip and Locking Notch or Equal
OVER MOLD ORIENTATION	Straight
CONNECTOR PIN OUT:	Center Positive (+V)
ADDITIONAL REQUIREMENTS	

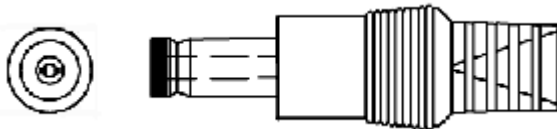

ADDITIONAL OUTPUT PLUG OPTIONS ARE AVAILABLE AT <http://www.globtek.com/connectors/>  
 STANDARD PLUGS AND CONNECTORS CAN BE SEEN ONLINE AT <http://www.globtek.com/connectors/>



GlobTek, Inc.  
 www.globtek.com  
 186 Veterans Drive,  
 Northvale, NJ 07647  
 Tel. (201) 784-1000  
 Fax (201) 784-0111

Drawing Title: GTM961200P12024-T3, ITE / Medical Power Supply, Efficiency Level: VI, Case Color/Style: GlobTek Black, Desktop/External, Regulated Switchmode AC-DC Power Supply AC Adaptor, Input Rating: 100-240V~, 50-60 Hz, IEC 60320/C14 , Output Rating: 120W, 24V@5A, Output Configuration: 1200 mm, 16/2 Cond, UL 2468, Female Barrel 5.5\*2.1\*11mm WITH internal Spring Clip and Locking Notch or Equal, Ferrite: Core Size: 14.2\*28.5\*8.2, GlobTek Black, GT Cord # C11224, Pin Out: Center Positive (+V), Blades/Input Cord: Not Applicable, Approvals: RCM CCC EAC cETLus cETLus cETLus ETL S-Mark CB CB CB ETL CB VCCI CB S-Mark WEEE Ukraine RoHS PSE Level VI China RoHS CE Class I PSE PSE PSE

Model No. GTM961200P12024-T3

Part No./Ordering No. TR9CI5000CCP-IM(R6B)

Rev D

**LABEL:L-1186**

LABEL P/N: Standard GT  
 MATERIAL: Flat Thermal Transfer, Imprintable, Polyester Label and/or Pad Printed and/or Molded, and/or Laser Engraved in the case  
 BACKGROUND COLOR: Black if housing is Black, White or Silver if housing is White or Gray.  
 TEXT COLOR: White or Silver if label is Black Background for Black housing. Black if label is White or Silver background and Housing is White or Gray  
 LABEL WIDTH (mm): 50  
 LABEL HEIGHT (mm): 110

Below is the minimum information which will appear on the label. NOTE: in the logo area additional/actual positioning of symbols and text is subjected to change as per agency updates/requirements or additional model approvals become available. Regulatory certifications/label markings may be in logo area on the label or molded into the case housing outside the label area. Information will be shown via label and/or pad printed and/or molded and/or laser engraved in the case. \* Date code markings at GlobTek option.



↑  
 XXX = USA or CHINA

**DATE CODE A \*:**

**DATE CODE LABEL**



Series NO.      Week Year  
 ↑                    ↑                    ↑  
 Class NO. for production

or

**DATE CODE B \*:**

**WWYY**  
 WW = WEEK  
 YY = YEAR

A=ITE / Medical Power Supply  
 B=P/N: (料号) TR9CI5000CCP-IM(R6B)  
 C=Model (型号) GTM961200P12024-T3  
 D=Input (输入) 100-240V~, 50-60 Hz, 1.5 A  
 E=Output (输出) 24 V 5 A, 120.0W

- AGENCY ONLINE DOCUMENTS <http://www.globtek.info/certs/GTM961200P/>
- CE EC-Declaration for Medical [http://www.globtek.com/pdf/ec\\_declaration/a0Oa000000MjJKDEA3](http://www.globtek.com/pdf/ec_declaration/a0Oa000000MjJKDEA3)
- CE EC-Declaration for Industrial/Commercial/ITE [http://www.globtek.com/pdf/ec\\_declaration/a0Oa000000MjJKDEA3](http://www.globtek.com/pdf/ec_declaration/a0Oa000000MjJKDEA3)
- RoHS/RoHS2 Declaration [http://www.globtek.com/pdf/rohs\\_cert/01ta0000007dRFjAAM](http://www.globtek.com/pdf/rohs_cert/01ta0000007dRFjAAM)
- REACH Declaration [http://www.globtek.com/pdf/iso\\_certificates/REACH.pdf](http://www.globtek.com/pdf/iso_certificates/REACH.pdf)

GlobTek, Inc.  
www.globtek.com  
186 Veterans Drive,  
Northvale, NJ 07647  
Tel. (201) 784-1000  
Fax (201) 784-0111

Drawing Title: GTM961200P12024-T3, ITE / Medical Power Supply, Efficiency Level: VI, Case Color/Style: GlobTek Black, Desktop/External, Regulated Switchmode AC-DC Power Supply AC Adaptor, Input Rating: 100-240V~, 50-60 Hz, IEC 60320/C14 , Output Rating: 120W, 24V@5A, Output Configuration: 1200 mm, 16/2 Cond, UL 2468, Female Barrel 5.5\*2.1\*11mm WITH internal Spring Clip and Locking Notch or Equal, Ferrite: Core Size: 14.2\*28.5\*8.2, GlobTek Black, GT Cord # C11224, Pin Out: Center Positive (+V), Blades/Input Cord: Not Applicable, Approvals: RCM CCC EAC cETLus cETLus cETLus ETL S-Mark CB CB CB ETL CB VCCI CB S-Mark WEEE Ukraine RoHS PSE Level VI China RoHS CE Class I PSE PSE PSE

Model No. GTM961200P12024-T3

Part No./Ordering No. TR9CI5000CCP-IM(R6B)

Rev D

Conflict Minerals Declaration

<http://www.globtek.com/pdf/conflict-minerals.pdf>

IPXY rating is based on 3rd party testing and customers should check suitability and test system level IPXY rating before ordering.

## Regulatory Certifications/Label Markings

LATEST PRODUCT/MODEL CERTIFICATIONS: <http://en.globtek.com/datasheet/id/a0Oa000000MjJKD>

AGENCY ONLINE DOCUMENTS: <http://www.globtek.info/certs/GTM961200P/>

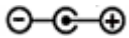

Center Positive (+V)

GlobTek, Inc.  
www.globtek.com  
186 Veterans Drive,  
Northvale, NJ 07647  
Tel. (201) 784-1000  
Fax (201) 784-0111

Drawing Title: GTM961200P12024-T3, ITE / Medical Power Supply, Efficiency Level: VI, Case Color/Style: GlobTek Black, Desktop/External, Regulated Switchmode AC-DC Power Supply AC Adaptor, Input Rating: 100-240V~, 50-60 Hz, IEC 60320/C14 , Output Rating: 120W, 24V@5A, Output Configuration: 1200 mm, 16/2 Cond, UL 2468, Female Barrel 5.5\*2.1\*11mm WITH internal Spring Clip and Locking Notch or Equal, Ferrite: Core Size: 14.2\*28.5\*8.2, GlobTek Black, GT Cord # C11224, Pin Out: Center Positive (+V), Blades/Input Cord: Not Applicable, Approvals: RCM CCC EAC cETLus cETLus cETLus ETL S-Mark CB CB CB ETL CB VCCI CB S-Mark WEEE Ukraine RoHS PSE Level VI China RoHS CE Class I PSE PSE PSE

Model No. GTM961200P12024-T3

Part No./Ordering No. TR9CI5000CCP-IM(R6B)

Rev D

## PACKAGING

Packing Spec P/N: Standard DT, Cellular packaging  
Box Qty: 20  
Gift Box Size (mm): Egg Crate  
Gift Box Color: None  
Master Carton Size (mm): 450\*461\*182  
Master GW (Kg): 16.0 kg  
BLADES INCLUDED: N/A:  
BLADE/CORD INSTALLED: N/A:

If specific packaging is required, this section must specify all requirements and note "no exceptions". If this section does not specify packaging, it is subject to change without notice at GlobTek's discretion.

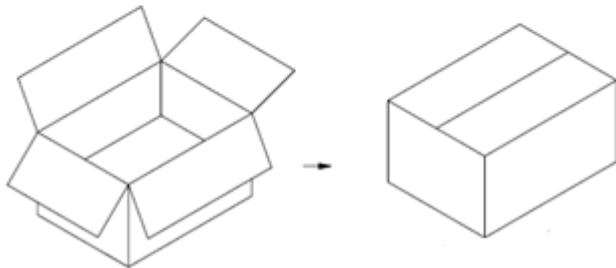
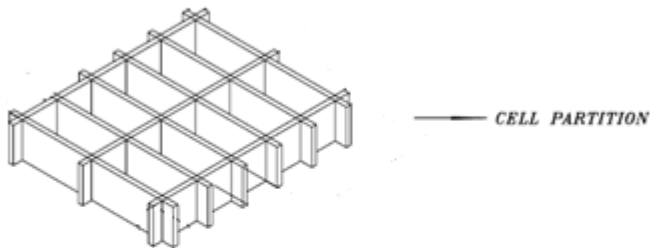
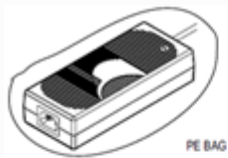

GlobTek, Inc.  
www.globtek.com  
186 Veterans Drive,  
Northvale, NJ 07647  
Tel. (201) 784-1000  
Fax (201) 784-0111

Drawing Title: GTM961200P12024-T3, ITE / Medical Power Supply, Efficiency Level: VI, Case Color/Style: GlobTek Black, Desktop/External, Regulated Switchmode AC-DC Power Supply AC Adaptor, Input Rating: 100-240V~, 50-60 Hz, IEC 60320/C14 , Output Rating: 120W, 24V@5A, Output Configuration: 1200 mm, 16/2 Cond, UL 2468, Female Barrel 5.5\*2.1\*11mm WITH internal Spring Clip and Locking Notch or Equal, Ferrite: Core Size: 14.2\*28.5\*8.2, GlobTek Black, GT Cord # C11224, Pin Out: Center Positive (+V), Blades/Input Cord: Not Applicable, Approvals: RCM CCC EAC cETLus cETLus cETLus ETL S-Mark CB CB CB ETL CB VCCI CB S-Mark WEEE Ukraine RoHS PSE Level VI China RoHS CE Class I PSE PSE PSE

Model No. GTM961200P12024-T3

Part No./Ordering No. TR9CI5000CCP-IM(R6B)

Rev D

## INSTRUCTION SHEET

N/A