

ITEM	QTY	PART NUMBER	DESCRIPTION
1	1	F040017	D16EER13
2	1	F050102	50-001-02 ROUND CONCAVE TRANSPARENT LENS
3	1	F050413	50-004-13 220VAC GREEN NEON

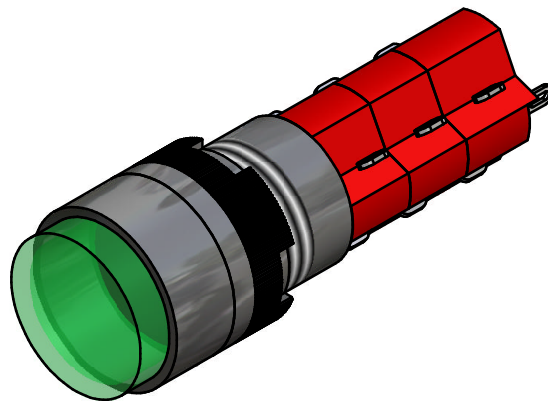

PANEL MOUNTING

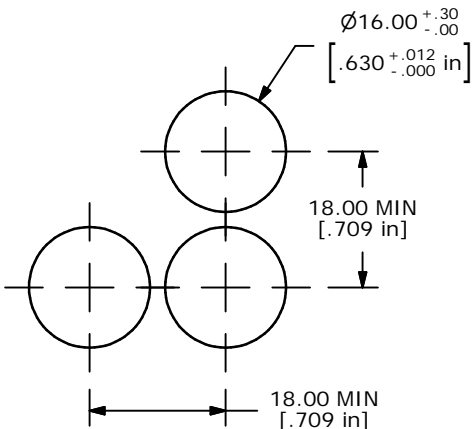
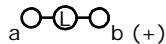
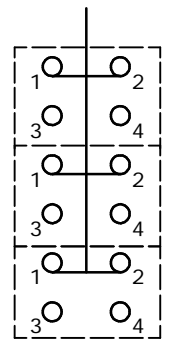

CONTACT CONFIGURATION

NOTE:

1. ALL DIMENSIONS IN MM [INCH]
2. GENERAL TOLERANCE: X.X=±0.4  
X.XX=±0.25
3. TERMINAL NUMBERS FOR REF ONLY
4. MECHANICAL LIFE: 2,000,000 OPERATIONS
5. INSULATION RESISTANCE: 1,000 MILLI-OHM MIN.
6. OPERATING TEMP.: -25°C to 55°C
- ▲ 7. LAMP VOLTAGE: 220VAC GREEN NEON
8. ▲ DENOTES CRITICAL PARAMETER.

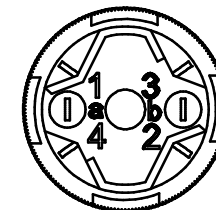
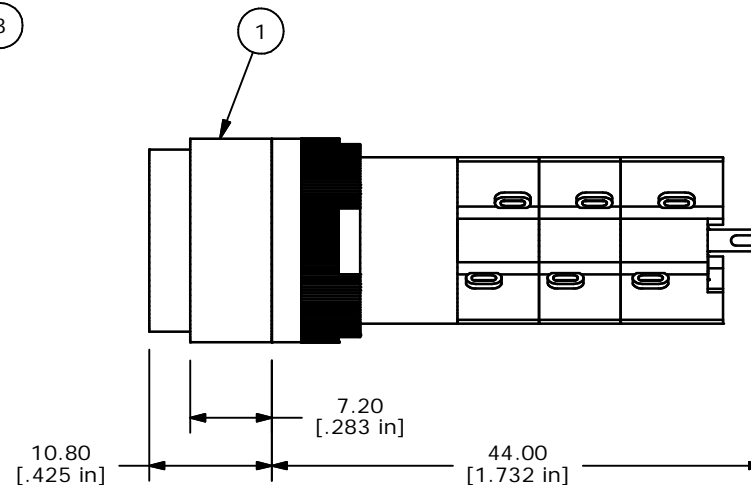
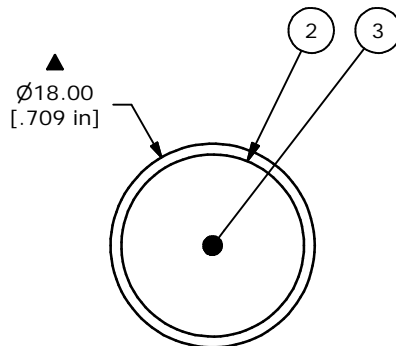

**E-SWITCH®**

TITLE D16EER13GGRNGRN

REV	PCR NO	DESCRIPTION	DATE	BY
A	14606	RELEASED FOR PRODUCTION	1/6/05	AR

SCALE	DATE	DR	DWG	REV
2:1	1/6/05	AR	XF0622P	A

THE INFORMATION CONTAINED IN THIS DOCUMENT IS PROPRIETARY TO E-SWITCH AND IS NOT TO BE COPIED OR TRANSFERRED