

## DETAILS

<b>Product Number</b>	FC13977_ANGELINA-RZ-S-B
<b>Family</b>	ANGELINA
<b>Type</b>	RefPack
<b>Color</b>	metal
<b>Diameter</b>	82 mm
<b>Height</b>	31 mm
<b>Style</b>	round
<b>Optic Material</b>	PC
<b>Holder Material</b>	
<b>Fastening</b>	screw, socket
<b>Status</b>	production ready
<b>ROHS Compliant</b>	Yes
<b>Date Updated</b>	13/06/2014



## OPTICAL PROPERTIES

LED	Viewing Angle	Light Beam	Efficiency	cd/lm	Connector
CLL03x/CLU03x	25 deg	Spot	89 %	1.820	A.A.G. STUCCHI: 8101/G2
CLL04x/CLU04x	33 deg	Spot	88 %	1.390	A.A.G. STUCCHI: 8102/G2
CXA/B 25xx	30 deg	Spot	88 %	1.500	BJB: 47.319.2141
LUXEON K12	27 deg	Spot	89 %	1.600	BJB: 47.319.2070
LUXEON K16	29 deg	Spot	89 %	1.500	BJB: 47.319.2070
LUXEON CoB 1216	34 deg	Spot	88 %	1.350	BJB: 47.319.2030
COB D Series LES 14.5 mm	27 deg	Spot	89 %	1.710	A.A.G. STUCCHI: 8101/G2
COB D Series LES 14.5 mm	27 deg	Spot	89 %	1.710	BJB: 47.319.2021
Tiger Zenigata (GWTGCBG4FD)	23 deg	Spot	91 %	2.000	BJB: 47.319.2051

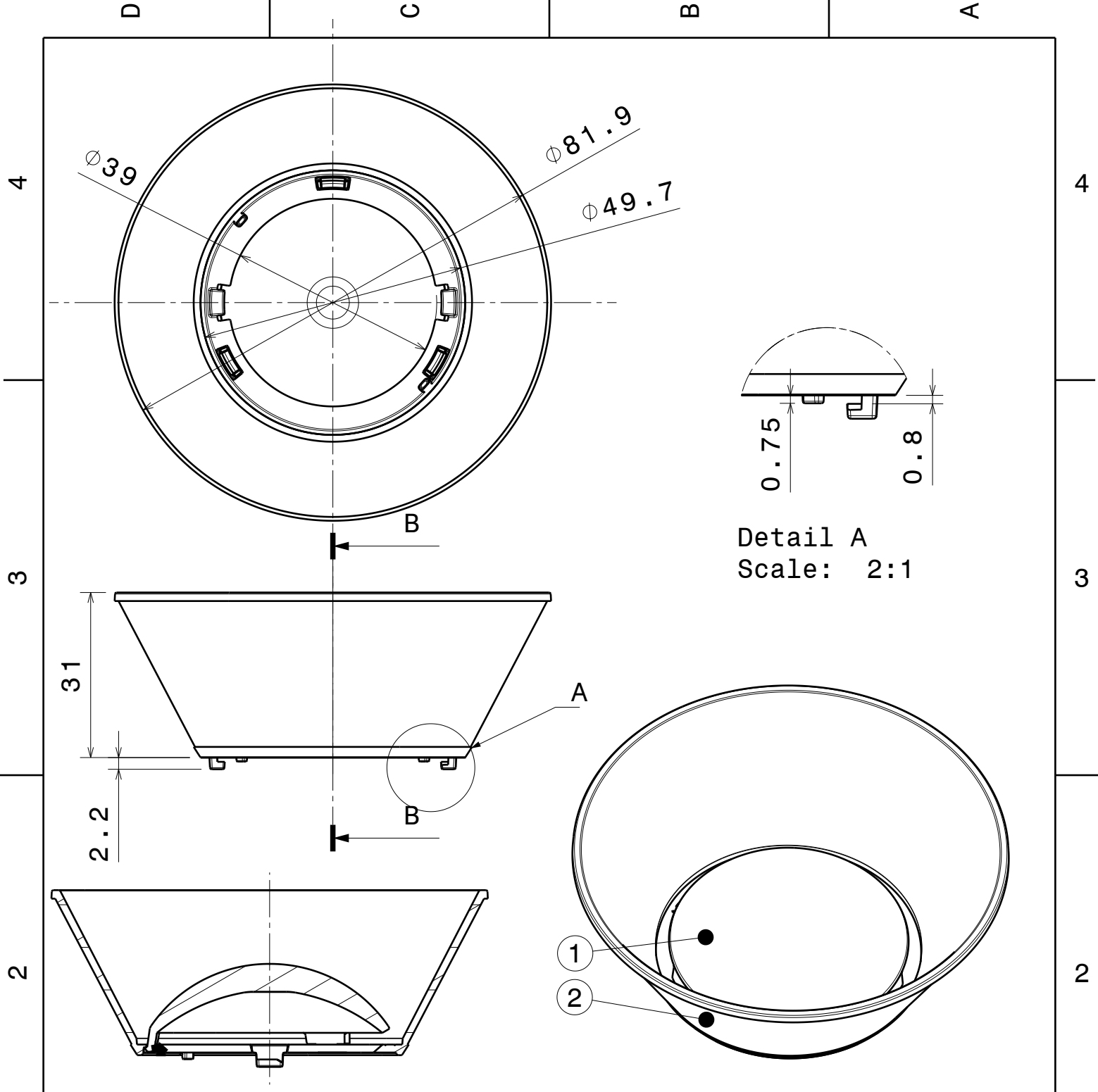

Section view B-B  
Scale: 1:1

Detail A  
Scale: 2:1

INDEX	PART NO	DESCRIPTION	MATERIAL	COLOUR
1		ANGE-RZ-lens	PC	
2		ANGELINA-B reflector	PC	metal

Tolerances if not otherwise shown  
According to DIN ISO 2768-1  
Linear measures:  
Up to 30mm class M, otherwise class C.  
According to DIN ISO 2768-2  
Form and position: class L

**LEDiL** Oy  
Salorankatu 10  
FIN 24240 SALO  
Finland

THIRD ANGLE PROJECTION:

DRAWING TITLE  
**Angelina-B-RZ Assy**

This drawing is the property of LEDiL Oy. It may not be reproduced, copied or communicated without a written agreement with LEDiL Oy."

SIZE PART NUMBER  
**A4**

SCALE 1:1 WEIGHT 16,43 g SHEET 1/1

Luminaire: LEDiL Oy FC13977\_ANGELINA-RZ-S-B\_(CLU034)\_(Stucchi\_8101-G2)  
Lamps: 1 x Citizen\_CLU034\_(CLU034-1205B8-303M1A2)\_+\_ (Stucchi\_8101/G2)\_1150.05lm@250mA\_P=8.45123W\_I=0.250A

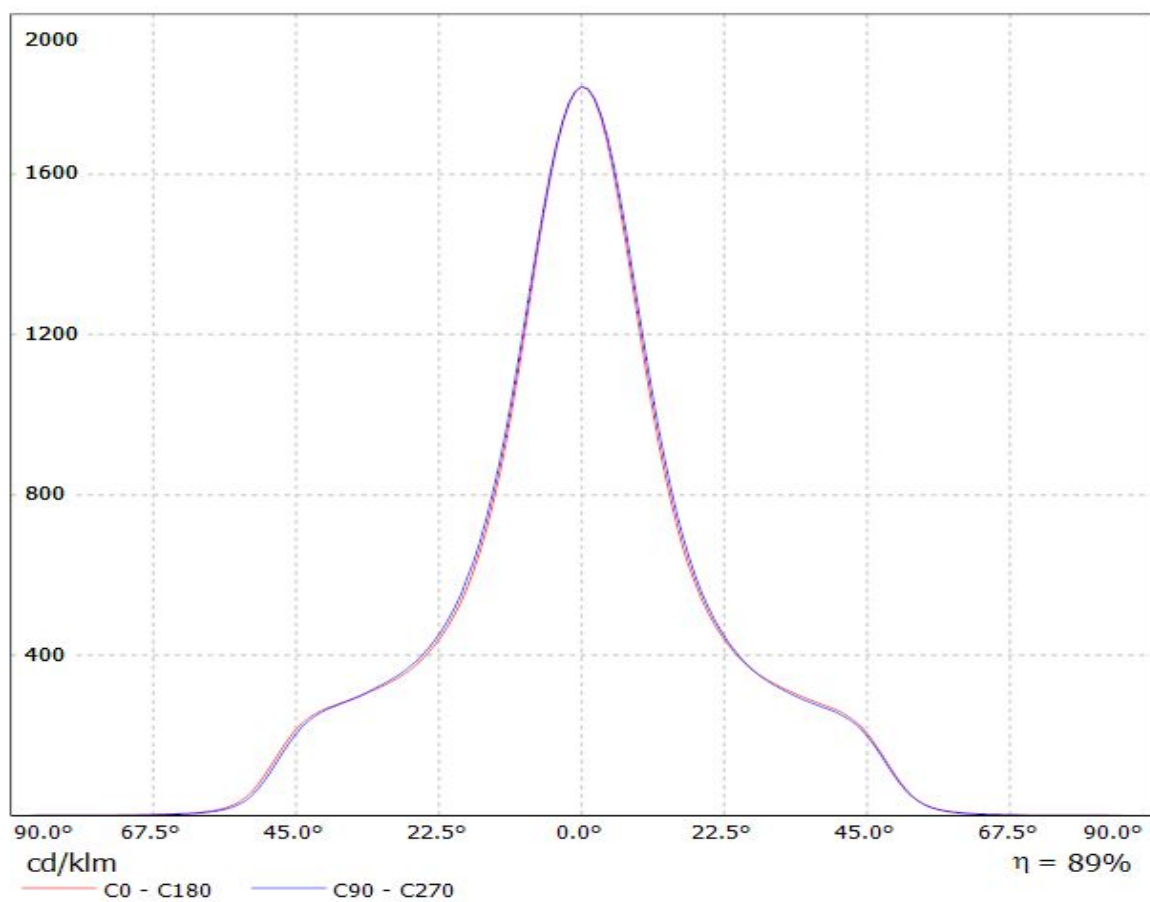



Luminaire: Ledil FC13977\_ANGELINA-RZ-S-B\_(CXB2540+\_BJB\_47.319.2140)  
Lamps: 1 x CREE\_CXB2540\_(-40G-W4-N0H-00002)  
+\_BJB\_47.319.2140\_1412.99lm@250mA\_CCT=40000K\_P=8.1310W\_I=0.25A

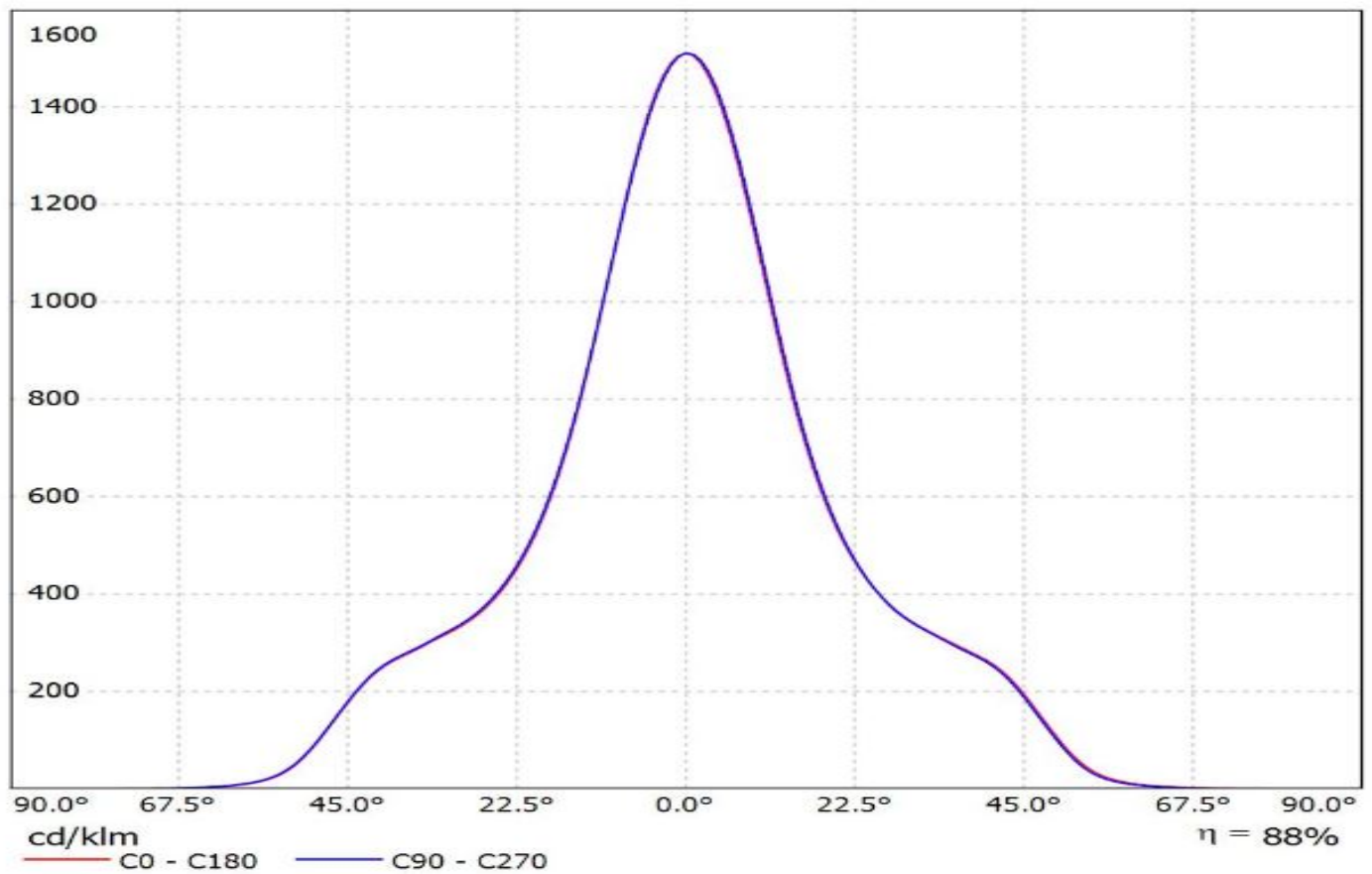

Luminaire: LEDil Oy FC13977\_ANGELINA-RZ-S-B\_(Luxeon\_K12) Efficiency=89%  
Lamps: 1 x Luxeon K12 (LXK8-PW40-0012) 930 lm @ 250mA CCT=4000K P=8.2W I=250mA

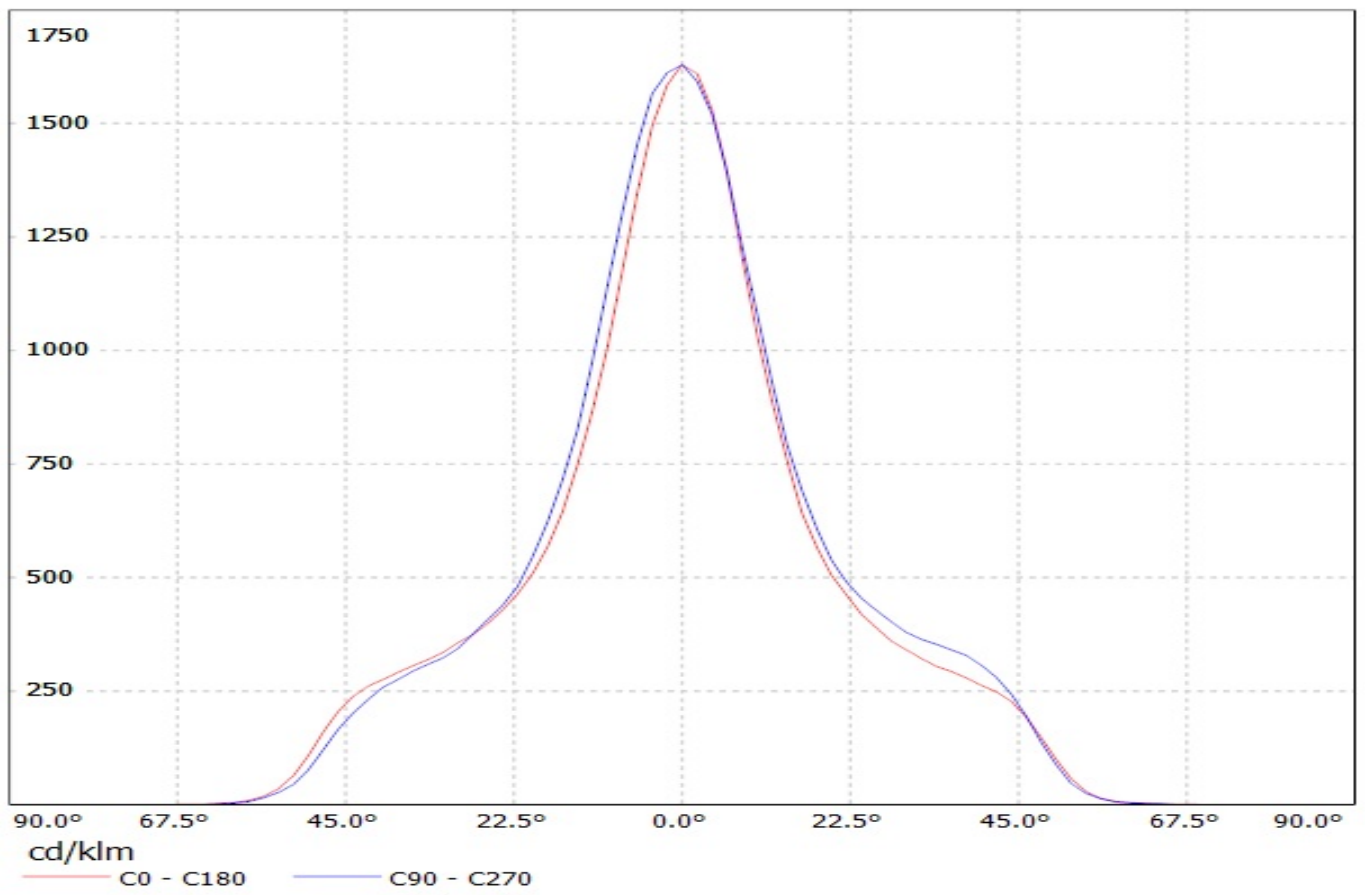

Luminaire: LEDil Oy FC13977\_ANGELINA-RZ-S-B\_(Luxeon\_K16) Efficiency=89%  
Lamps: 1 x Luxeon K16 (LXK8-PW40-0016) 1200lm @ 250mA CCT=4000K P=10.9W I=250mA

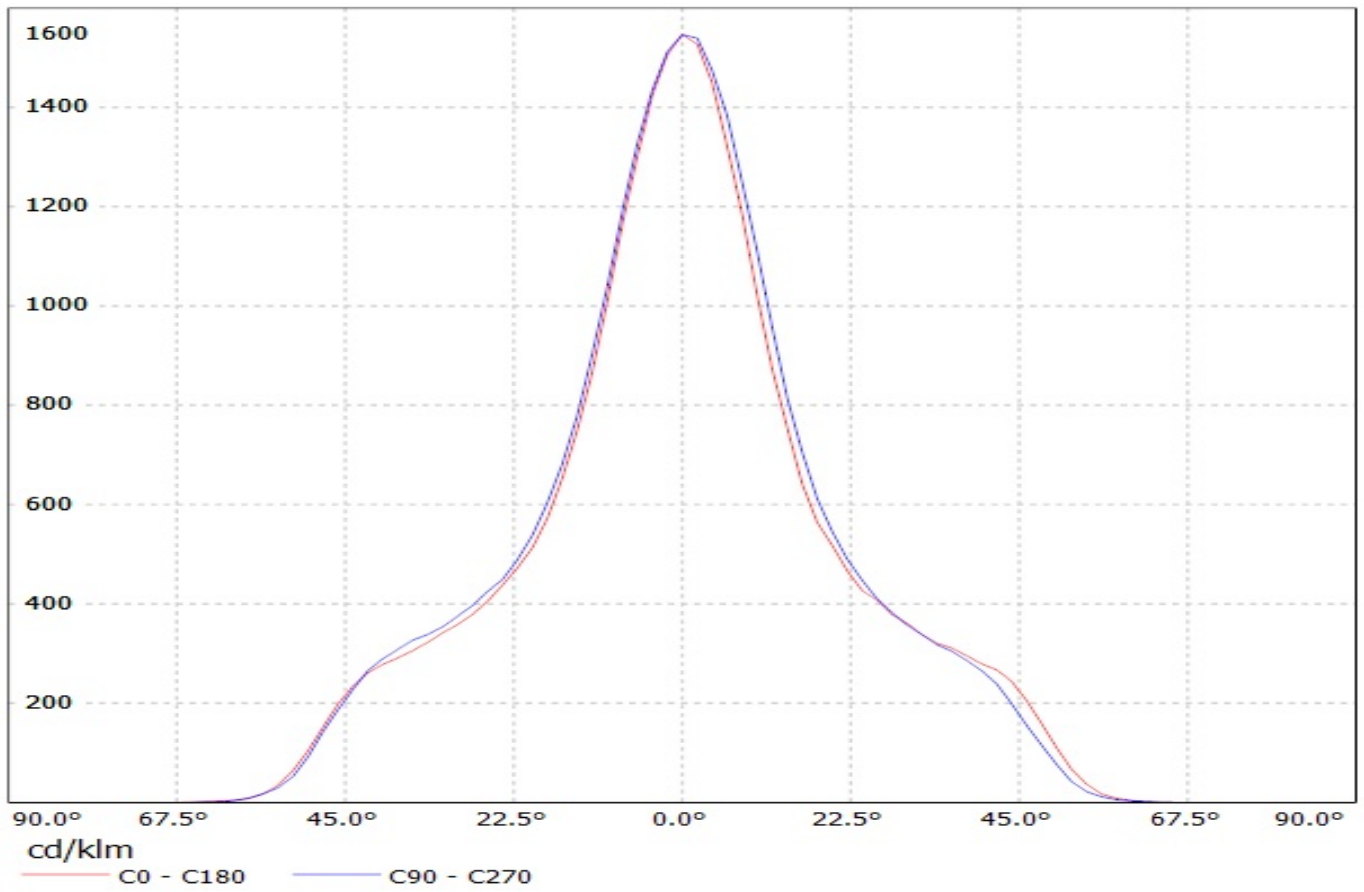

Luminaire: Ledil FC13977\_ANGELINA-RZ-S-B\_(CoB\_1216)

Lamps: 1 x Luxeon\_CoB\_1216\_(L2C2-40801216E2300)\_1478.81lm@250mA\_P=8.0033W\_I=0.25A

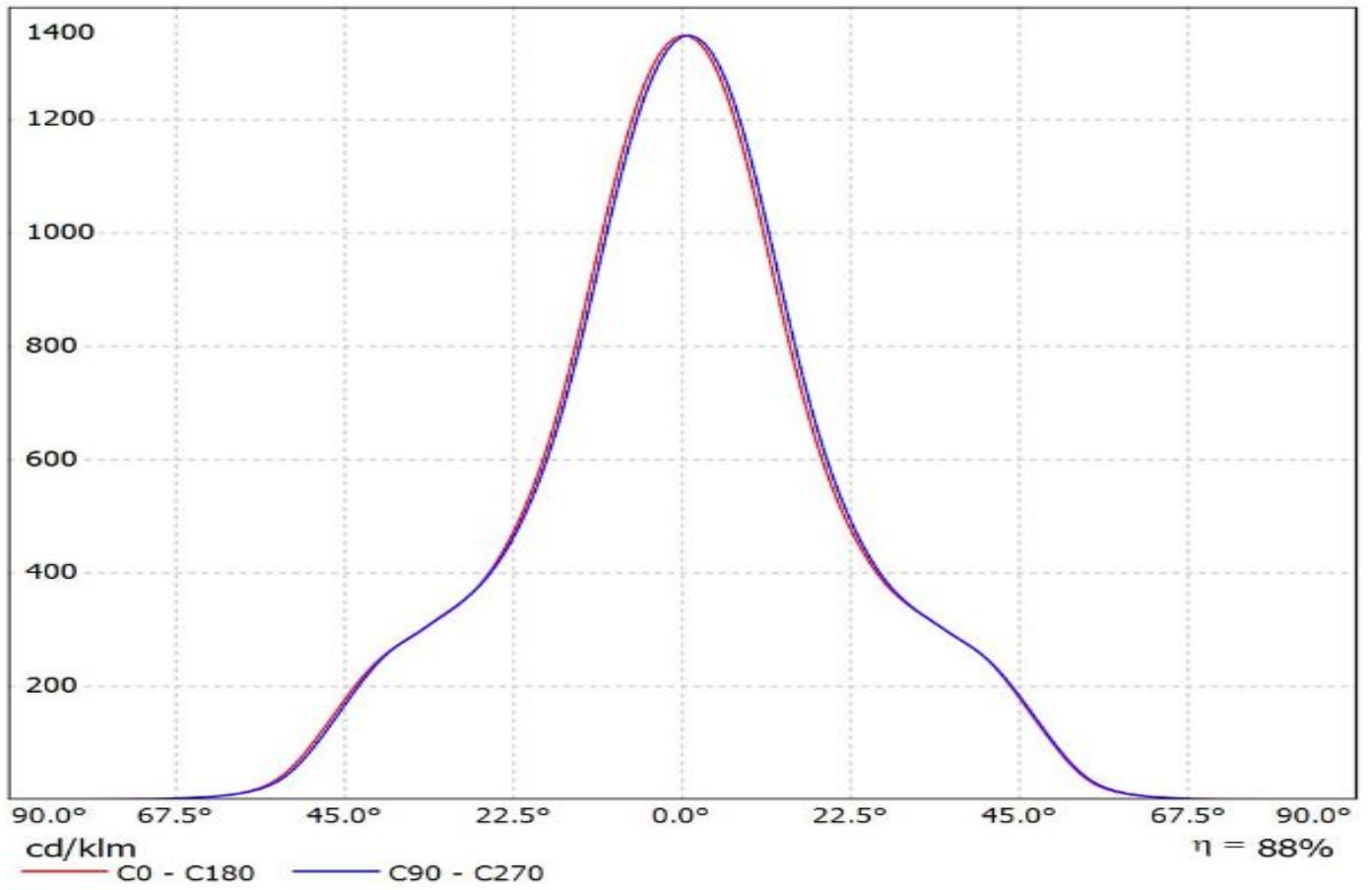



Luminaire: LEDiL Oy FC13977\_ANGELINA-RZ-S-B\_(COB\_D\_14,5mm)

Lamps: 1 x Samsung\_COB\_D\_Series-LES-14,5\_LC026D\_1296.34lm@250mA\_CCT=3000K\_P=8.1225W\_I=0.250A

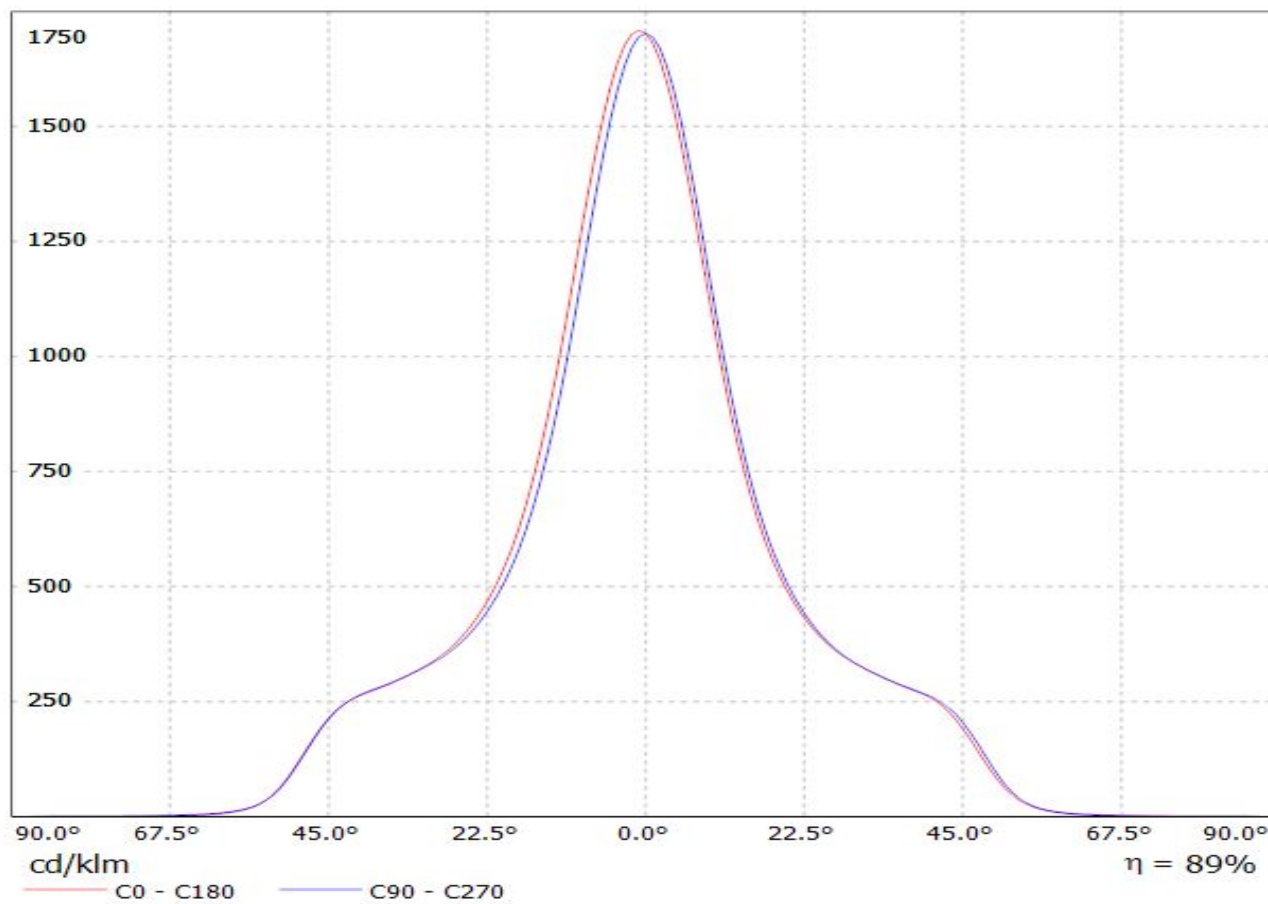

Luminaire: LEDiL Oy FC13977\_ANGELINA-RZ-S-B\_(COB\_D\_14,5mm)

Lamps: 1 x Samsung\_COB\_D\_Series-LES-14,5\_LC026D\_1296.34lm@250mA\_CCT=3000K\_P=8.1225W\_I=0.250A

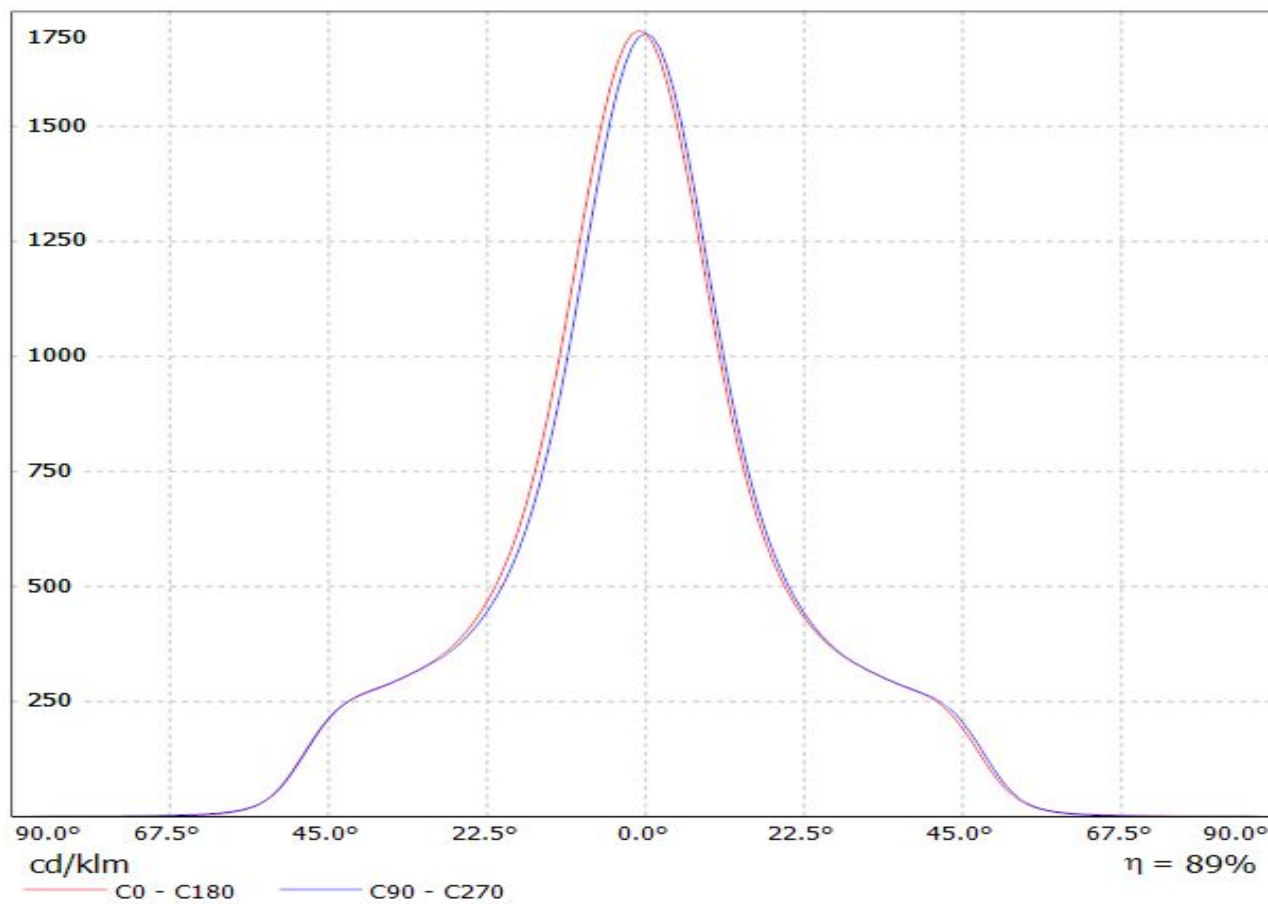

Luminaire: LEDiL Oy FC13977\_ANGELINA-RZ-S-B\_(Tiger) Eff.91%  
Lamps: 1 x SHARP TIGER\_ZENIGATA\_(GW6TGCBG4FD)\_836.646lm@250mA\_P=8.31759W\_I=249.8mA

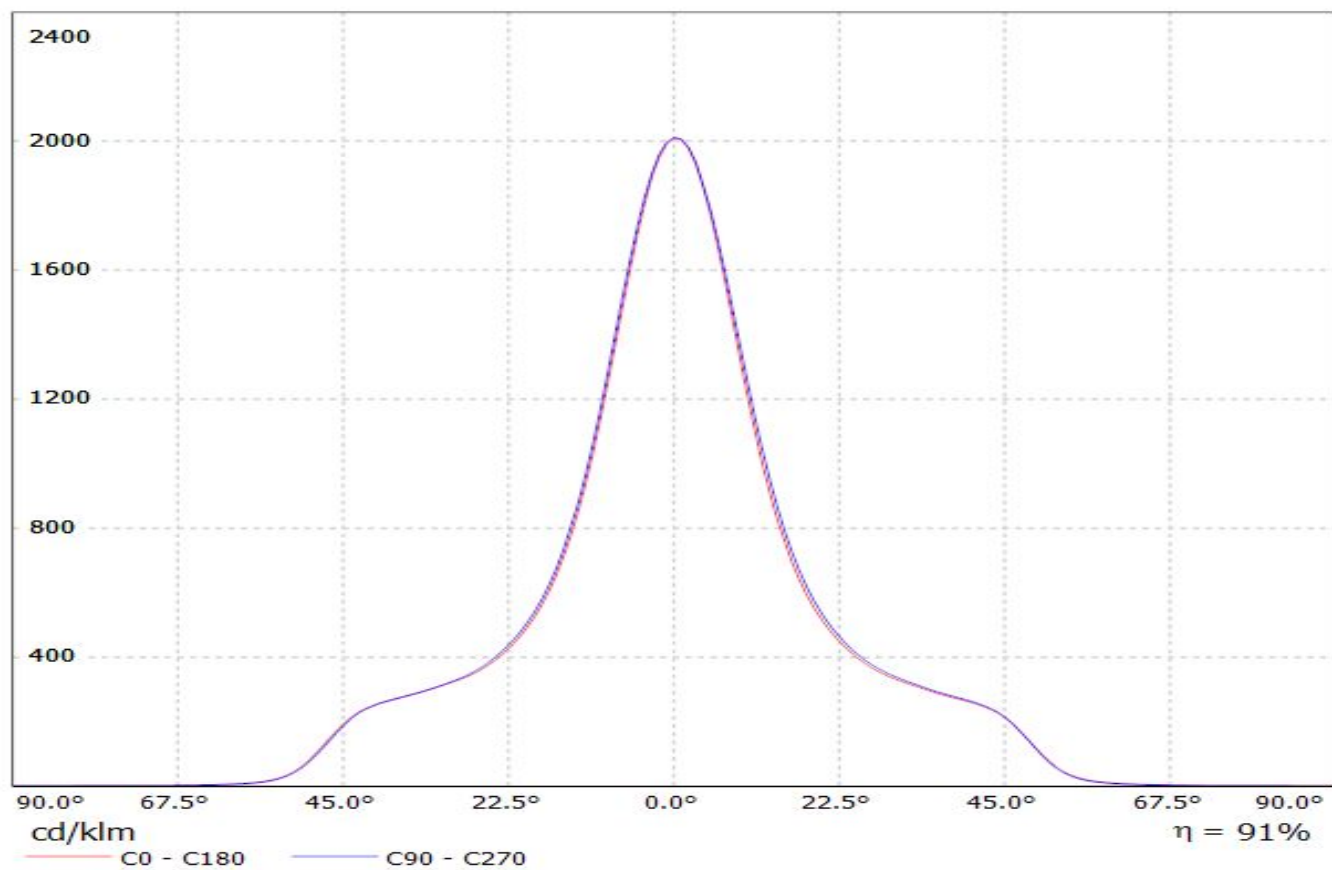

Luminaire: LEDiL Oy FC13977\_ANGELINA-RZ-S-B\_(CLU034)\_(Stucchi\_8101-G2)

Lamps: 1 x Citizen\_CLU034\_(CLU034-1205B8-303M1A2)\_+\_ (Stucchi\_8101/G2)\_1150.05lm@250mA\_P=8.45123W\_I=0.250A

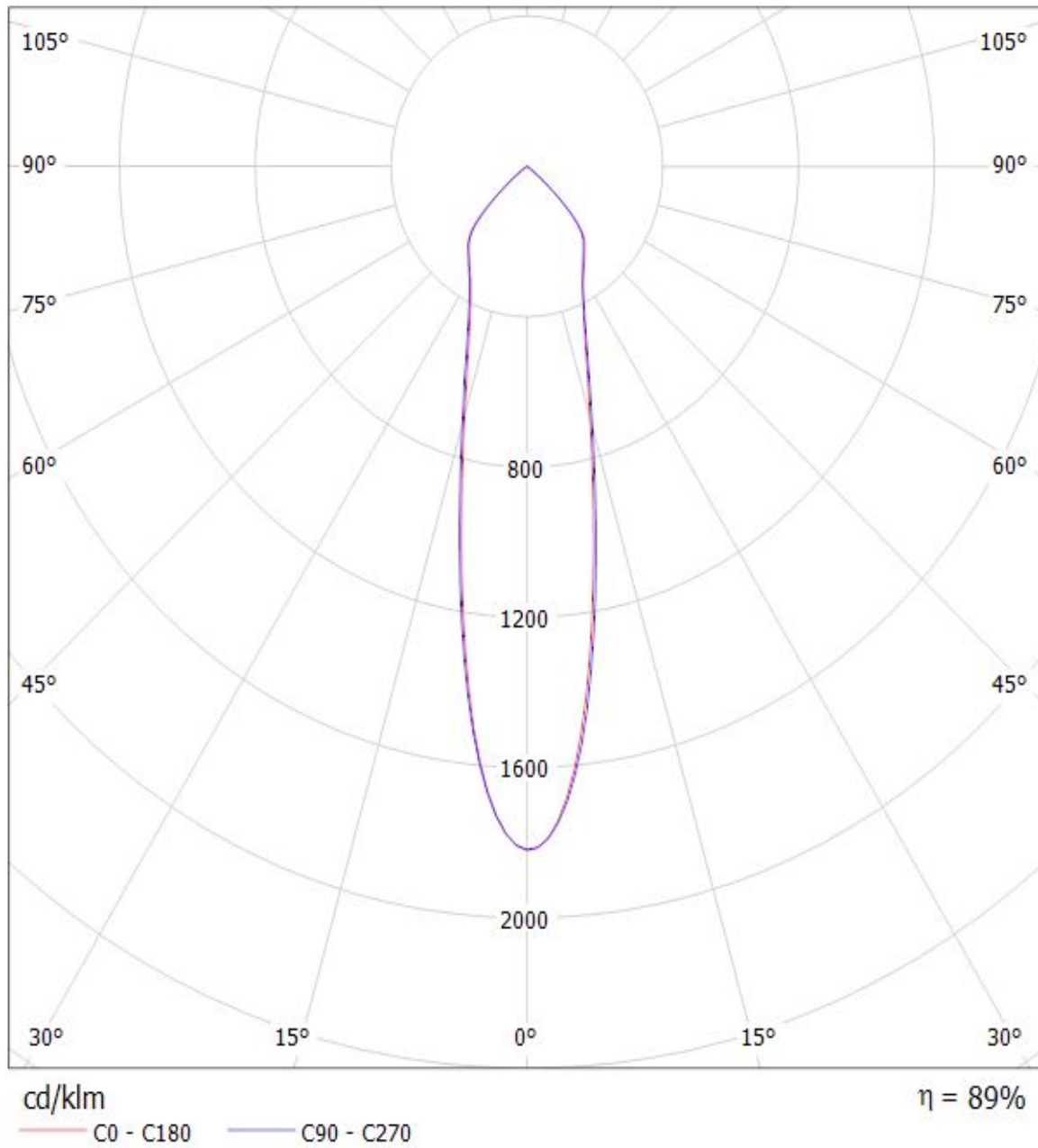

Luminaire: LEDiL Oy FC13977\_ANGELINA-RZ-S-B\_(CLU044)\_+\_ (Stucchi\_8102-G2)  
Lamps: 1 x Citizen\_CLU044\_(1212B8-303M1A2)\_+\_ (Stucchi\_8102/G2)\_1291.68lm@250mA\_P=8.13748W\_I=0.250A

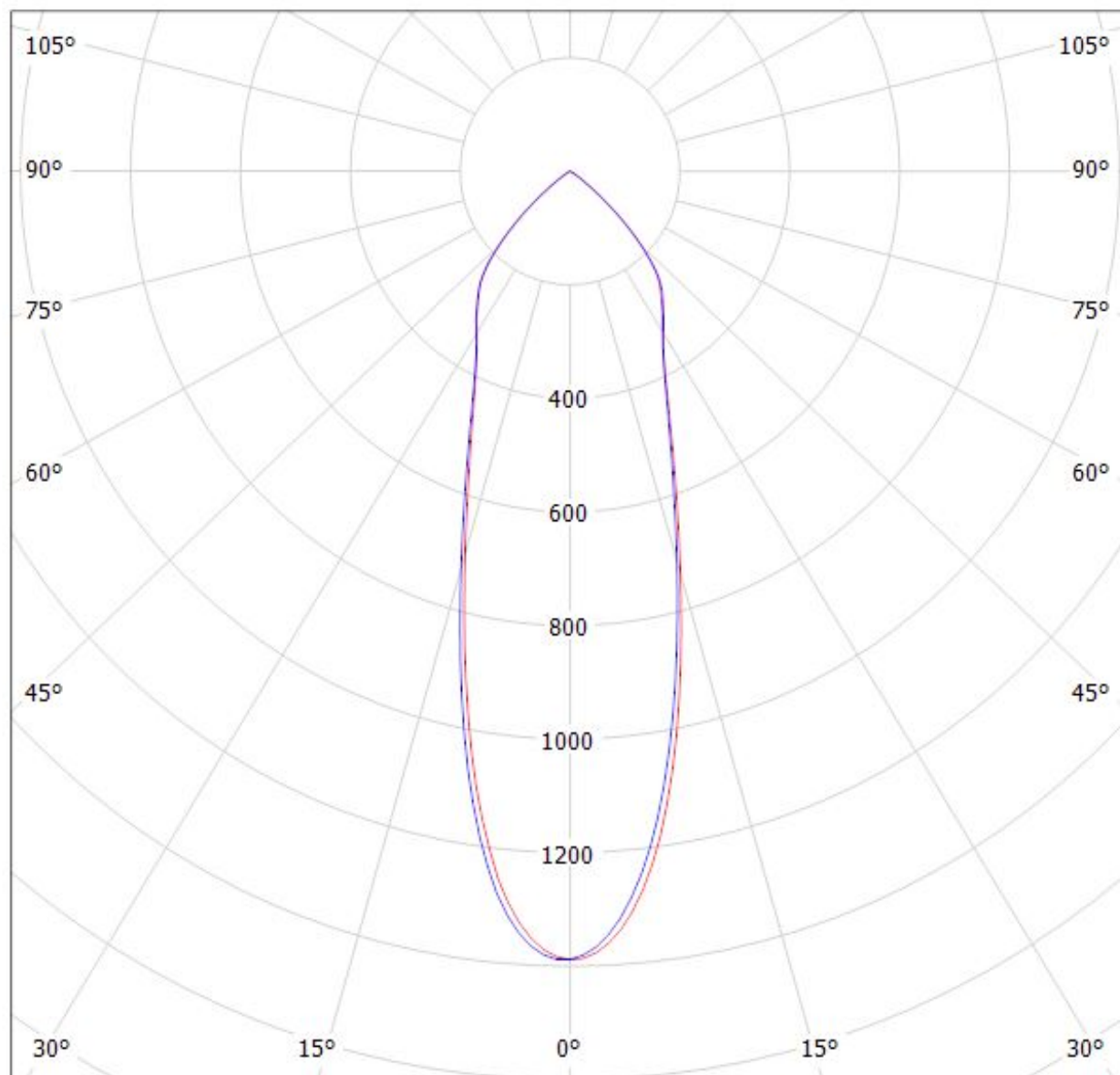

cd/klm

$\eta = 88\%$

— C0 - C180    — C90 - C270

Luminaire: Ledil FC13977\_ANGELINA-RZ-S-B\_(CXB2540+\_BJB\_47.319.2140)  
Lamps: 1 x CREE\_CXB2540\_(-40G-W4-N0H-00002)  
+\_BJB\_47.319.2140\_1412.99lm@250mA\_CCT=40000K\_P=8.1310W\_I=0.25A

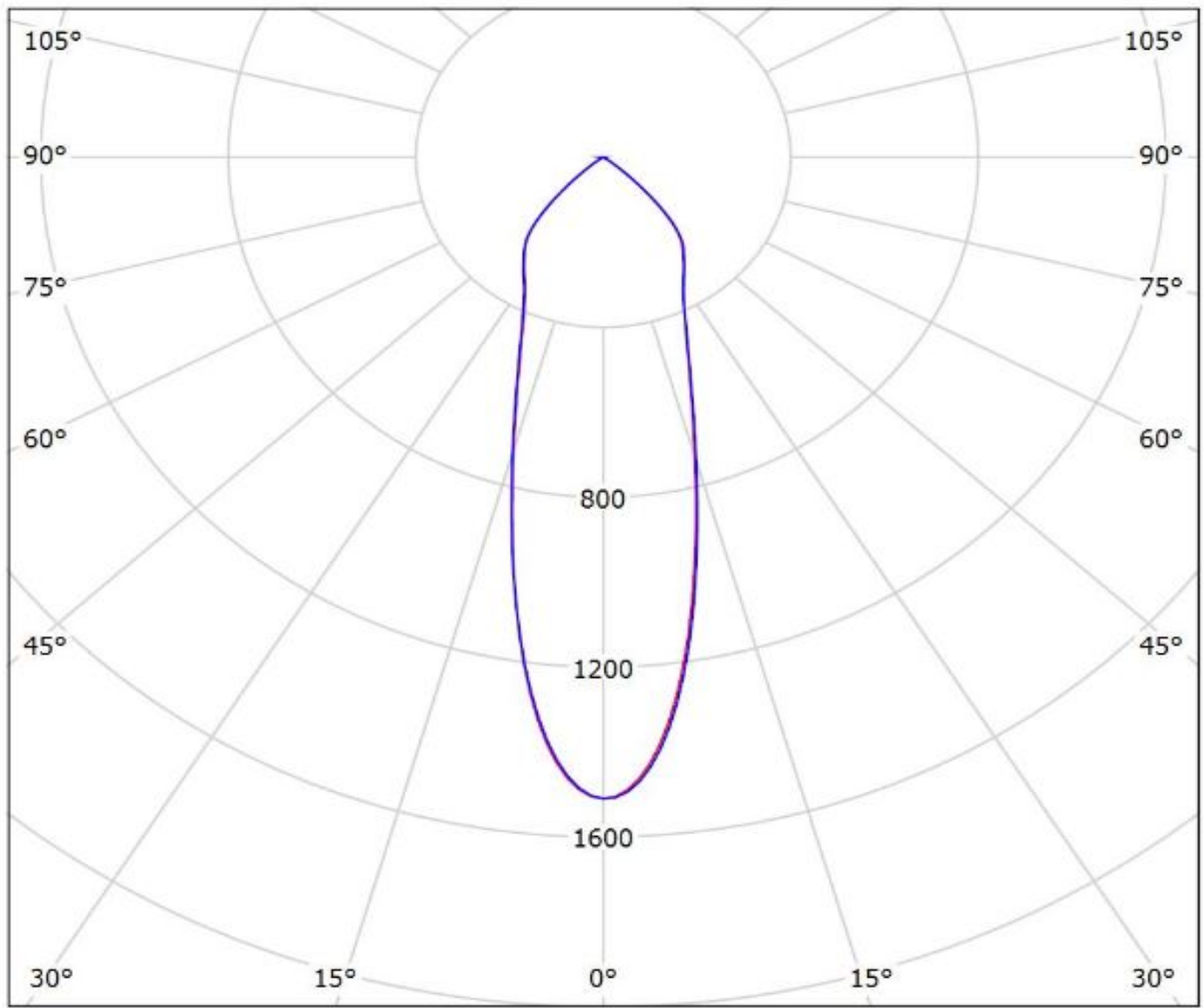

cd/klm

— C0 - C180 — C90 - C270

$\eta = 88\%$

Luminaire: LEDil Oy FC13977\_ANGELINA-RZ-S-B\_(Luxeon\_K12) Efficiency=89%  
Lamps: 1 x Luxeon K12 (LXK8-PW40-0012) 930 lm @ 250mA CCT=4000K P=8.2W I=250mA

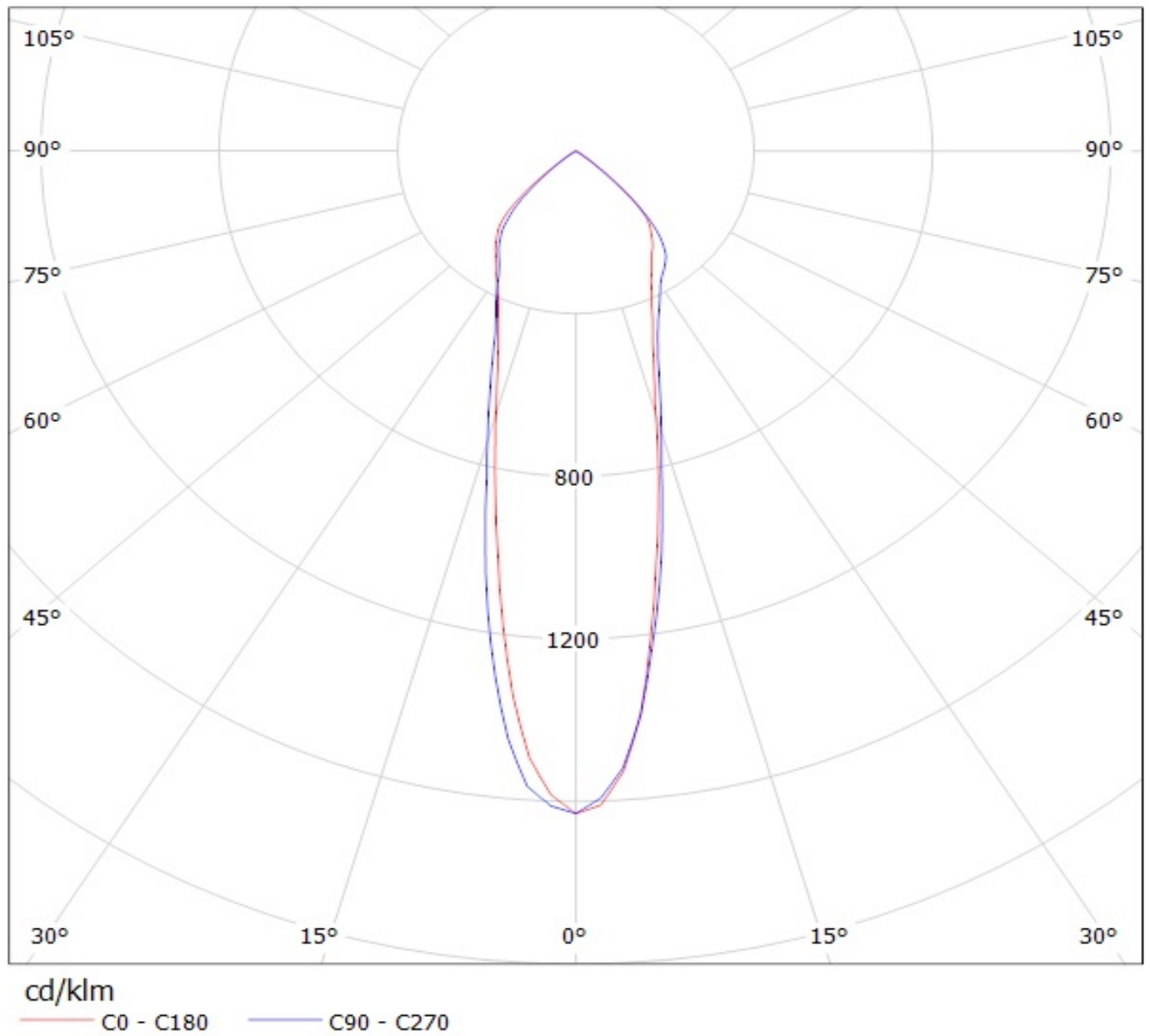

Luminaire: LEDil Oy FC13977\_ANGELINA-RZ-S-B\_(Luxeon\_K16) Efficiency=89%  
Lamps: 1 x Luxeon K16 (LXK8-PW40-0016) 1200lm @ 250mA CCT=4000K P=10.9W I=250mA

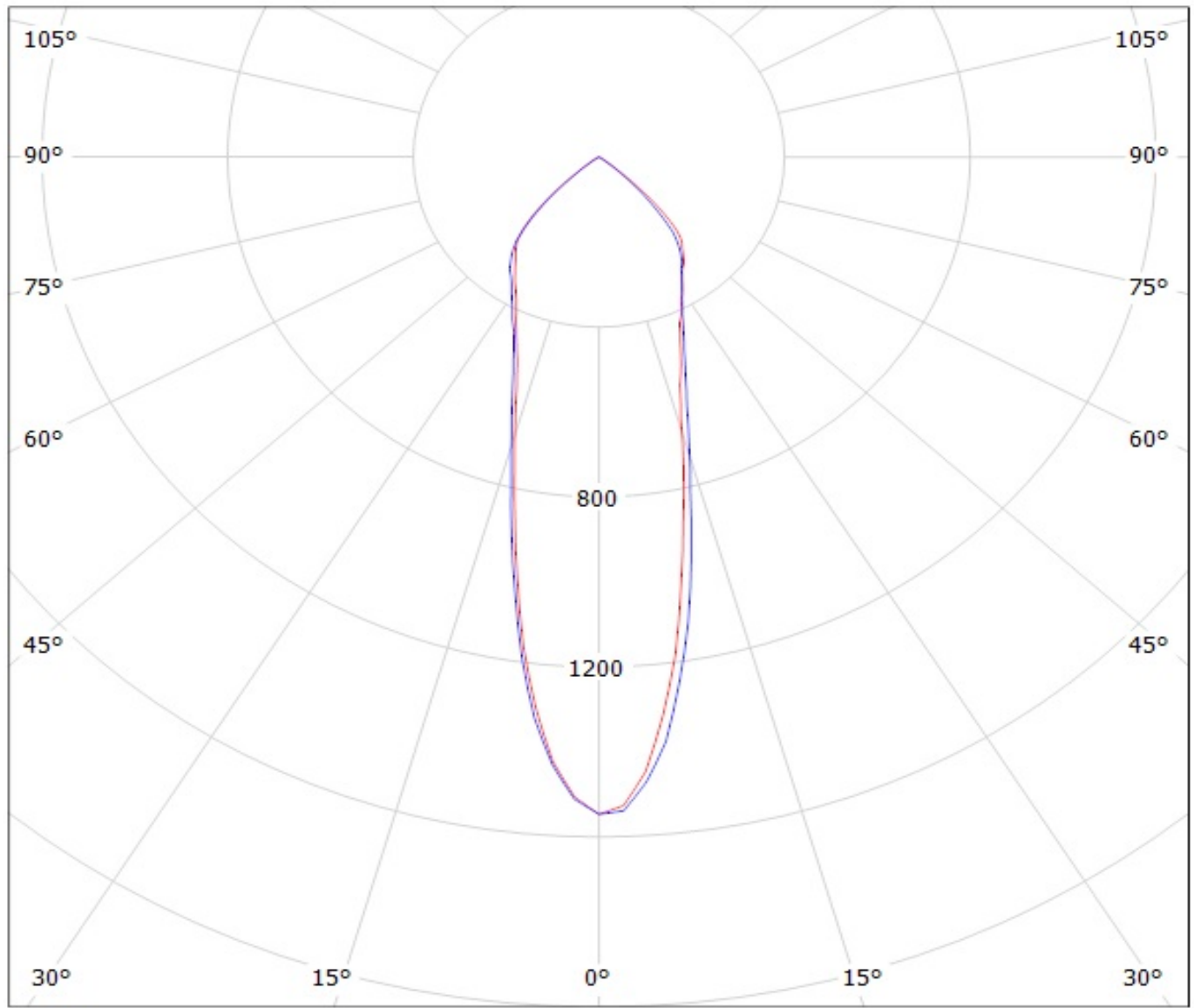

cd/klm

— C0 - C180

— C90 - C270



Luminaire: Ledil FC13977\_ANGELINA-RZ-S-B\_(CoB\_1216)

Lamps: 1 x Luxeon\_CoB\_1216\_(L2C2-40801216E2300)\_1478.81lm@250mA\_P=8.0033W\_I=0.25A

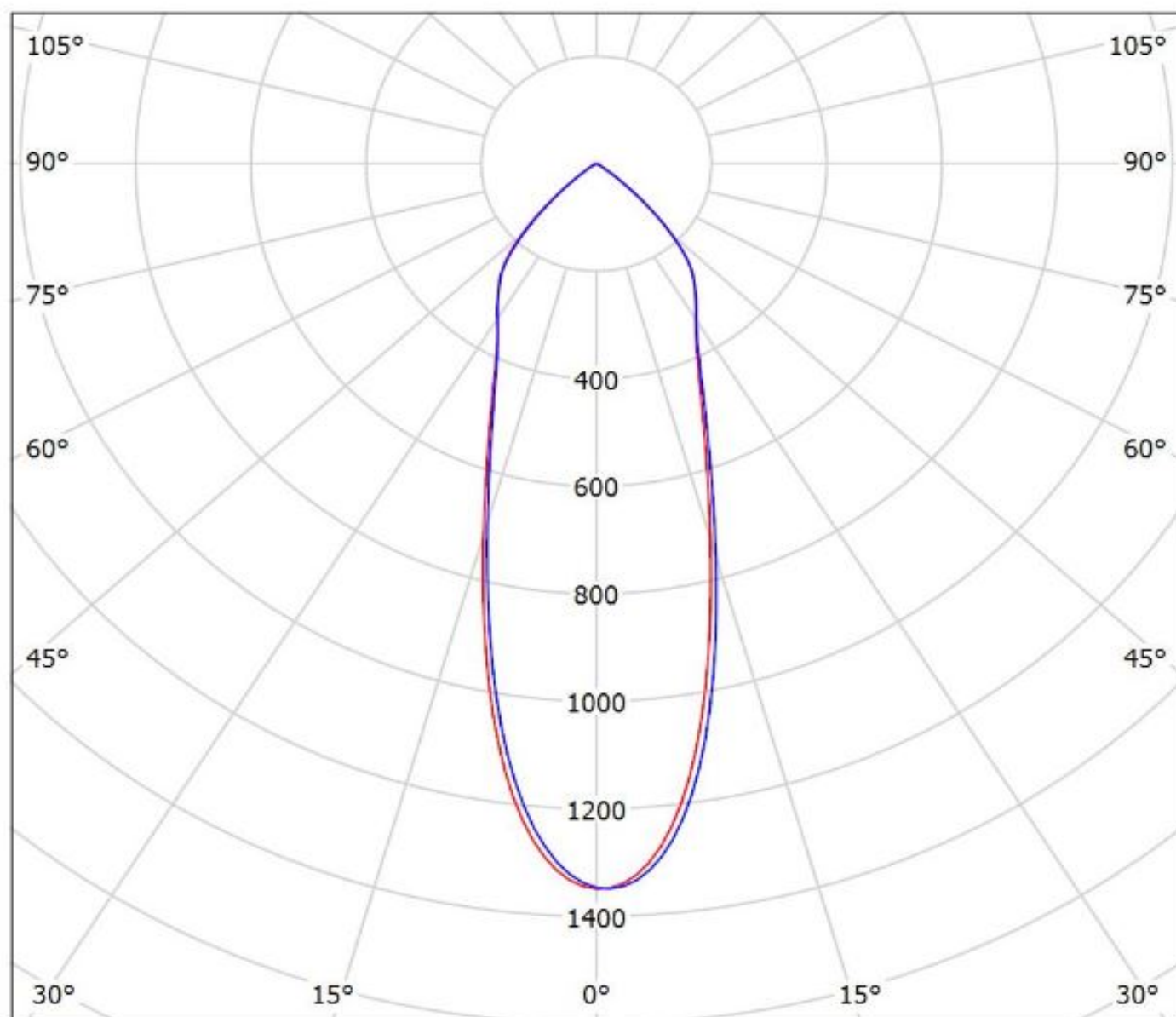

cd/klm

— C0 - C180 — C90 - C270

$\eta = 88\%$

Luminaire: LEDiL Oy FC13977\_ANGELINA-RZ-S-B\_(COB\_D\_14,5mm)

Lamps: 1 x Samsung\_COB\_D\_Series-LES-14,5\_LC026D\_1296.34lm@250mA\_CCT=3000K\_P=8.1225W\_I=0.250A

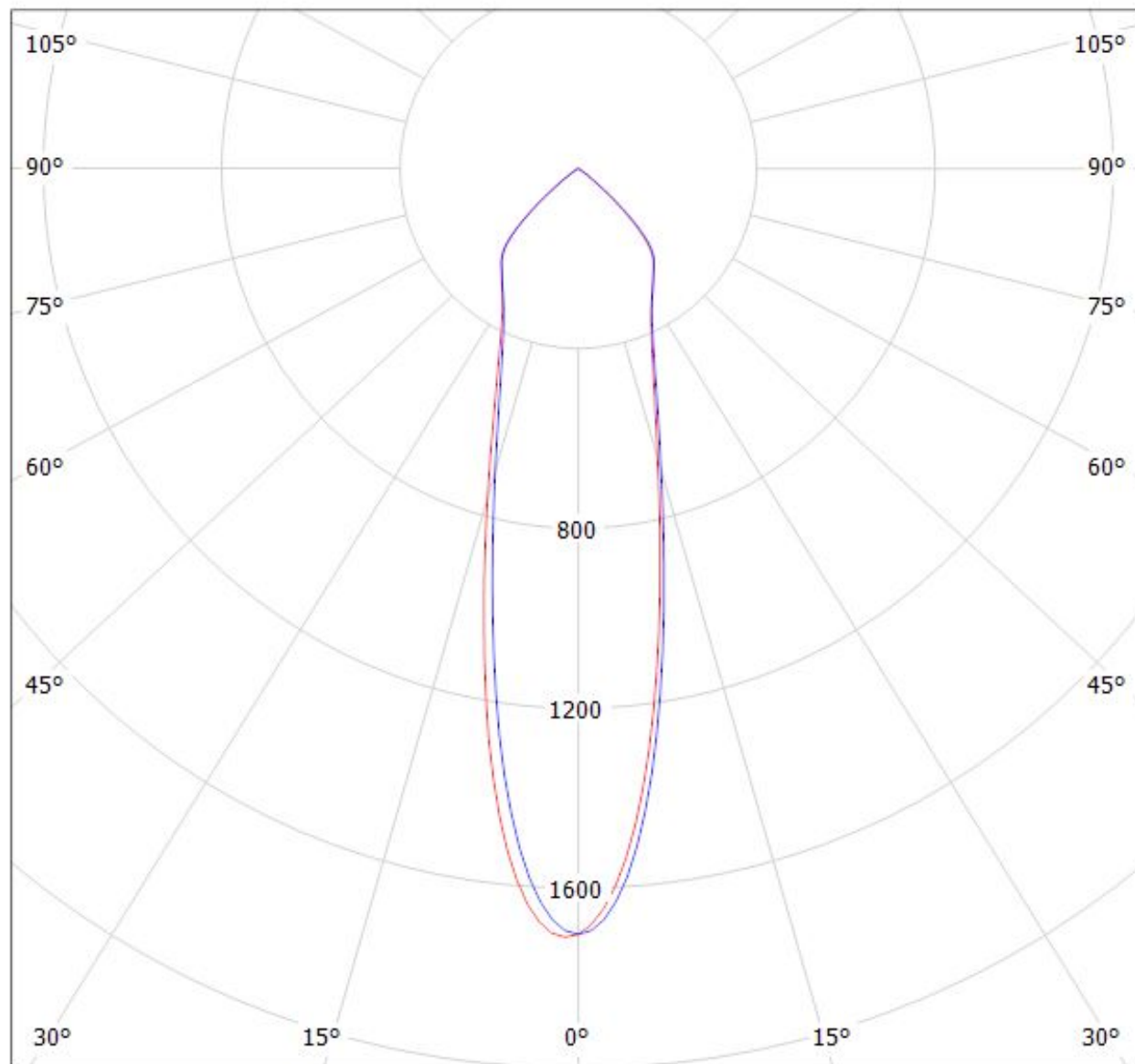

cd/klm

— C0 - C180

— C90 - C270

$\eta = 89\%$

Luminaire: LEDiL Oy FC13977\_ANGELINA-RZ-S-B\_(COB\_D\_14,5mm)

Lamps: 1 x Samsung\_COB\_D\_Series-LES-14,5\_LC026D\_1296.34lm@250mA\_CCT=3000K\_P=8.1225W\_I=0.250A

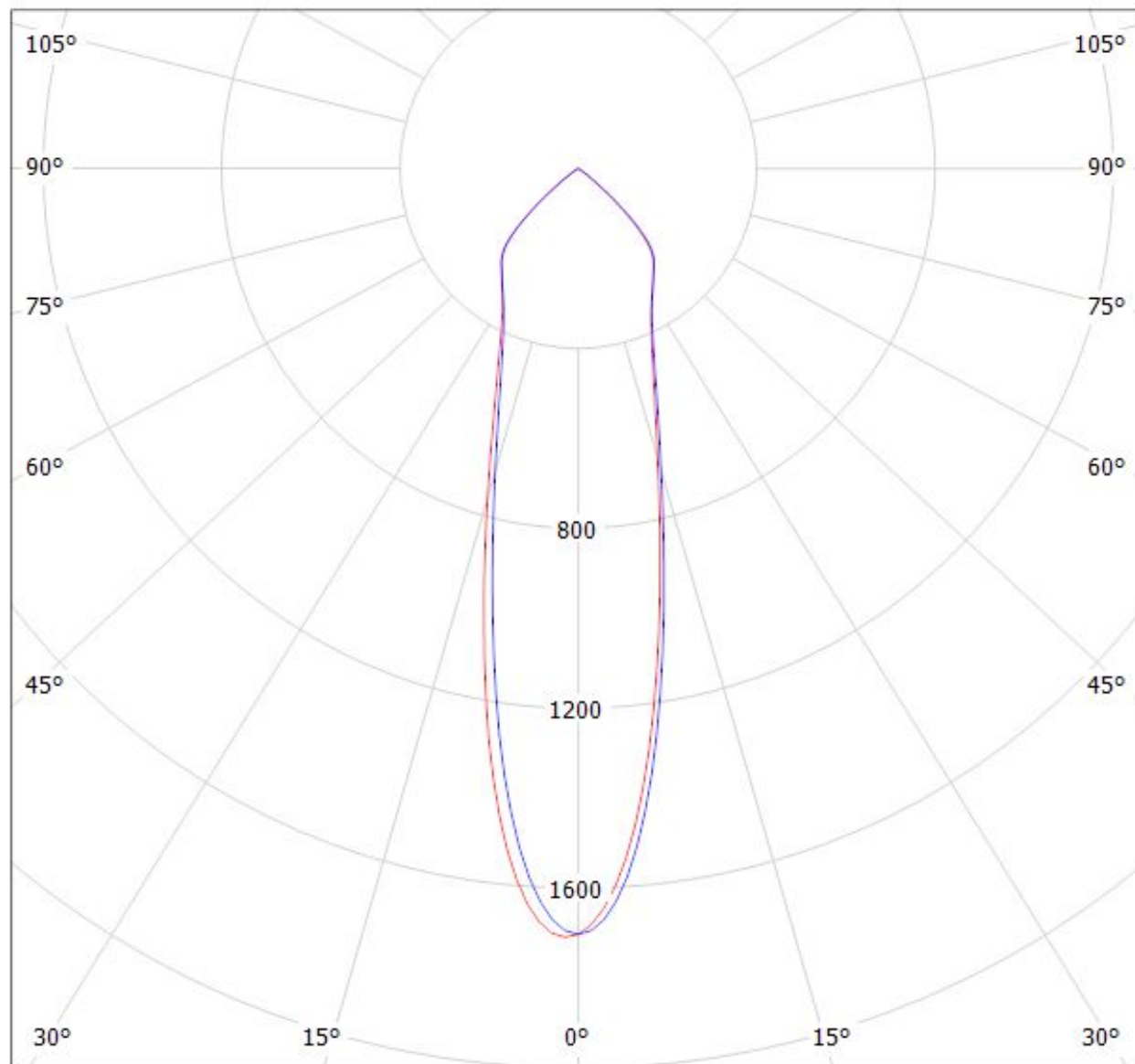

cd/klm

— C0 - C180

— C90 - C270

$\eta = 89\%$

Luminaire: LEDiL Oy FC13977\_ANGELINA-RZ-S-B\_(Tiger) Eff.91%  
Lamps: 1 x SHARP TIGER\_ZENIGATA\_(GW6TGCBG4FD)\_836.646lm@250mA\_P=8.31759W\_I=249.8mA

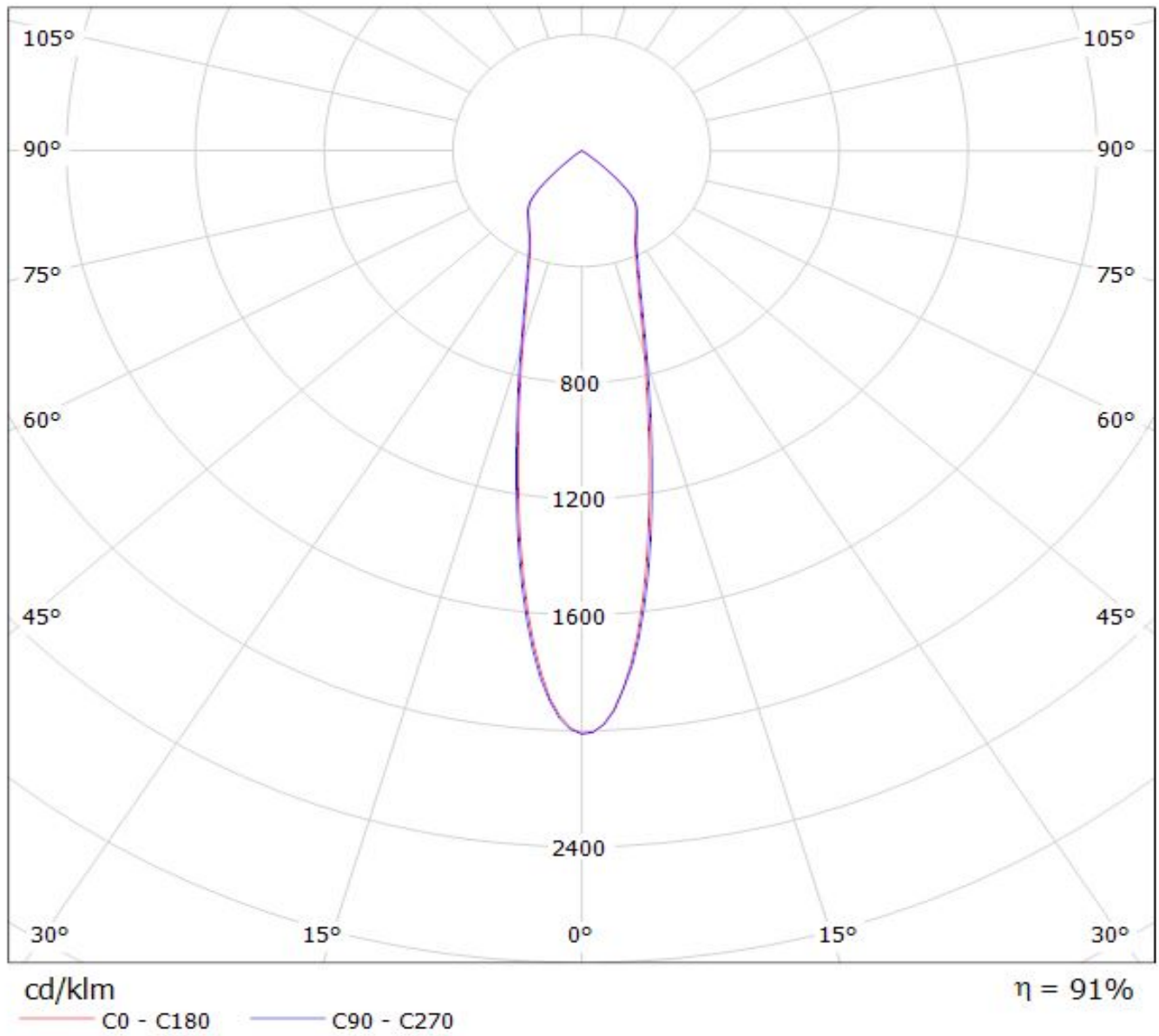

**NOTE: The typical divergence will be changed by different color, chip size and chip position tolerance. The typical total divergence is the full angle measured where the luminous intensity is half of the peak value.**

### **GENERAL INFORMATION**

- Product series especially designed & optimized for series of LEDs.
- Special care taken to make light distribution as uniform as possible.

Note! Due to use of high power COB's with this product, special attention to proper thermal design is highly recommended. LEDiL has no liability for direct, indirect or consecutive damages arising from the LEDiL products being used outside of the recommended temperature range.