

# MG2040, SZMG2040

## ESD Protection Diodes

### Low Capacitance ESD Protection for High Speed Video Interface

The MG2040 ESD protection diode is designed specifically to protect HDMI and Display Port with full functionality ESD protection and back drive current protection for V<sub>CC</sub> line. Ultra-low capacitance and low ESD clamping voltage make this device an ideal solution for protecting voltage sensitive high speed data lines. The flow-through style package allows for easy PCB layout and matched trace lengths necessary to maintain consistent impedance for the high speed TMDS lines.

#### Features

- Full Function HDMI / Display Port Solution
- Single Connect, Flow through Routing for TMDS Lines
- Low Capacitance (0.35 pF Typical, I/O to GND)
- Protection for the Following IEC Standards:  
IEC 61000-4-2 Level 4 (±8 kV Contact)
- UL Flammability Rating of 94 V-0
- SZ Prefix for Automotive and Other Applications Requiring Unique Site and Control Change Requirements; AEC-Q101 Qualified and PPAP Capable
- This is a Pb-Free Device

#### Typical Applications

- HDMI
- Display Port

#### MAXIMUM RATINGS (T<sub>J</sub> = 25°C unless otherwise noted)

Rating	Symbol	Value	Unit
Operating Junction Temperature Range	T <sub>J</sub>	-55 to +125	°C
Storage Temperature Range	T <sub>stg</sub>	-55 to +150	°C
Lead Solder Temperature – Maximum (10 Seconds)	T <sub>L</sub>	260	°C
IEC 61000-4-2 Contact (ESD)	ESD	±15	kV
IEC 61000-4-2 Air (ESD)	ESD	±15	kV

Stresses exceeding those listed in the Maximum Ratings table may damage the device. If any of these limits are exceeded, device functionality should not be assumed, damage may occur and reliability may be affected.

See Application Note AND8308/D for further description of survivability specs.



ON Semiconductor®

<http://onsemi.com>

#### MARKING DIAGRAM



UDFN18  
CASE 517CP

2040 = Specific Device Code  
M = Date Code  
▪ = Pb-Free Package

(Note: Microdot may be in either location)

#### ORDERING INFORMATION

Device	Package	Shipping
MG2040MUTAG	UDFN18 (Pb-Free)	3000 / Tape & Reel
SZMG2040MUTAG	UDFN18 (Pb-Free)	3000 / Tape & Reel

†For information on tape and reel specifications, including part orientation and tape sizes, please refer to our Tape and Reel Packaging Specification Brochure, BRD8011/D.

# MG2040, SZMG2040

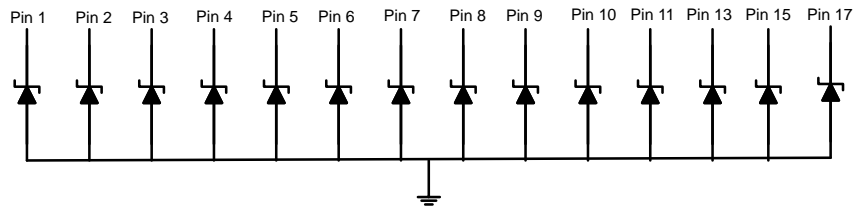

Center Pins, Pin 12, 14, 16, 18

Note: Common GND – Only Minimum of 1 GND connection required

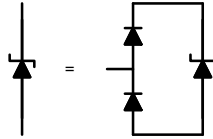

**Figure 1. Pin Schematic**

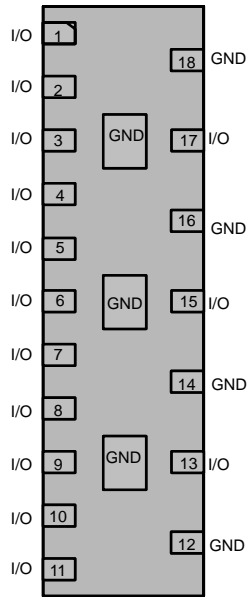

**Figure 2. Pin Configuration**

Note: Pins 12, 14, 16, 18 and center pins are connected internally as a common ground.  
Only minimum of one pin needs to be connected to ground for functionality of all pins.

# MG2040, SZMG2040

## ELECTRICAL CHARACTERISTICS ( $T_A = 25^\circ\text{C}$ unless otherwise specified)

Parameter	Symbol	Conditions	Min	Typ	Max	Unit
Reverse Working Voltage	$V_{RWM}$	I/O Pin to GND (Note 1)			5.0	V
Breakdown Voltage	$V_{BR}$	$I_T = 1 \text{ mA}$ , I/O Pin to GND	5.5			V
Reverse Leakage Current	$I_R$	$V_{RWM} = 5 \text{ V}$ , I/O Pin to GND			1.0	$\mu\text{A}$
Clamping Voltage (Note 1)	$V_C$	$I_{PP} = 1 \text{ A}$ , I/O Pin to GND (8 x 20 $\mu\text{s}$ pulse)			10	V
Clamping Voltage (Note 2)	$V_C$	IEC61000-4-2, $\pm 8 \text{ kV}$ Contact	See Figures 3 and 4			V
Clamping Voltage TLP (Note 3) See Figures 8 through 11	$V_C$	$I_{PP} = 8 \text{ A}$ $I_{PP} = 16 \text{ A}$ $I_{PP} = -8 \text{ A}$ $I_{PP} = -16 \text{ A}$		11.4 15.3 -4.6 -8.1		
Junction Capacitance	$C_J$	$V_R = 0 \text{ V}$ , $f = 1 \text{ MHz}$ between I/O Pins		0.15	0.20	pF
		$V_R = 0 \text{ V}$ , $f = 1 \text{ MHz}$ between I/O Pins and GND		0.35	0.42	
Junction Capacitance Difference	$\Delta C_J$	$V_R = 0 \text{ V}$ , $f = 1 \text{ MHz}$ between I/O Pins		0.02		pF
		$V_R = 0 \text{ V}$ , $f = 1 \text{ MHz}$ between I/O Pins and GND		0.04		

1. Surge current waveform per Figure 7.
2. For test procedure see Figures 5 and 6 and application note AND8307/D.
3. ANSI/ESD STM5.5.1 – Electrostatic Discharge Sensitivity Testing using Transmission Line Pulse (TLP) Model.  
TLP conditions:  $Z_0 = 50 \Omega$ ,  $t_p = 100 \text{ ns}$ ,  $t_r = 4 \text{ ns}$ , averaging window;  $t_1 = 30 \text{ ns}$  to  $t_2 = 60 \text{ ns}$ .

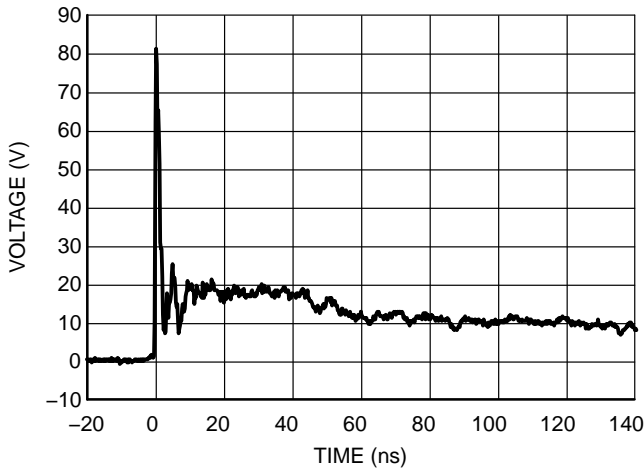

Figure 3. IEC61000-4-2 +8 KV Contact Clamping Voltage

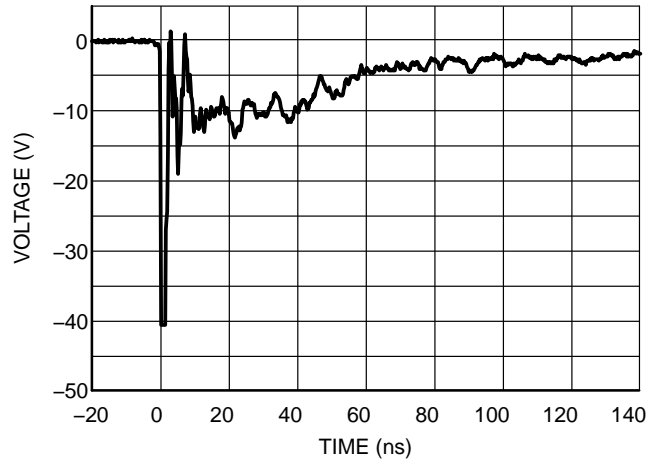

Figure 4. IEC61000-4-2 -8 KV Contact Clamping Voltage

# MG2040, SZMG2040

## IEC 61000-4-2 Spec.

Level	Test Voltage (kV)	First Peak Current (A)	Current at 30 ns (A)	Current at 60 ns (A)
1	2	7.5	4	2
2	4	15	8	4
3	6	22.5	12	6
4	8	30	16	8



Figure 5. IEC61000-4-2 Spec

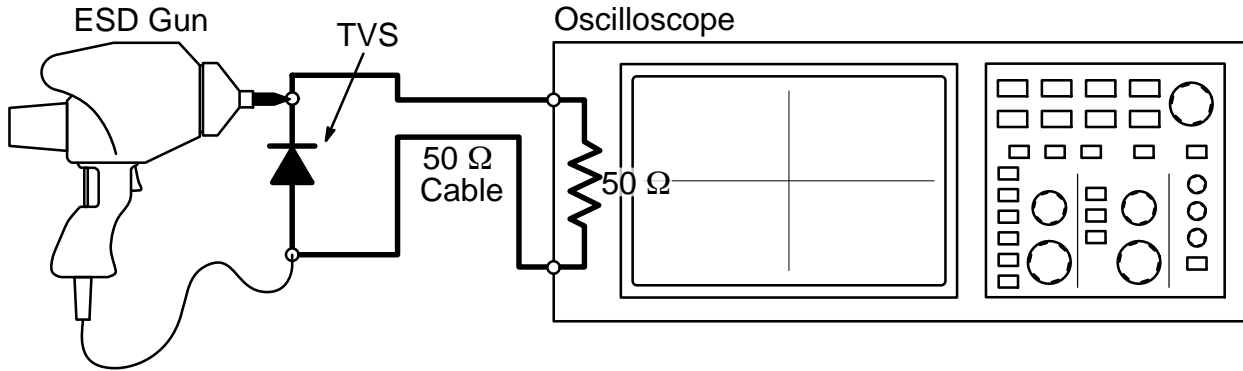

Figure 6. Diagram of ESD Clamping Voltage Test Setup

The following is taken from Application Note AND8308/D – Interpretation of Datasheet Parameters for ESD Devices.

### ESD Voltage Clamping

For sensitive circuit elements it is important to limit the voltage that an IC will be exposed to during an ESD event to as low a voltage as possible. The ESD clamping voltage is the voltage drop across the ESD protection diode during an ESD event per the IEC61000-4-2 waveform. Since the IEC61000-4-2 was written as a pass/fail spec for larger

systems such as cell phones or laptop computers it is not clearly defined in the spec how to specify a clamping voltage at the device level. ON Semiconductor has developed a way to examine the entire voltage waveform across the ESD protection diode over the time domain of an ESD pulse in the form of an oscilloscope screenshot, which can be found on the datasheets for all ESD protection diodes. For more information on how ON Semiconductor creates these screenshots and how to interpret them please refer to AND8307/D.

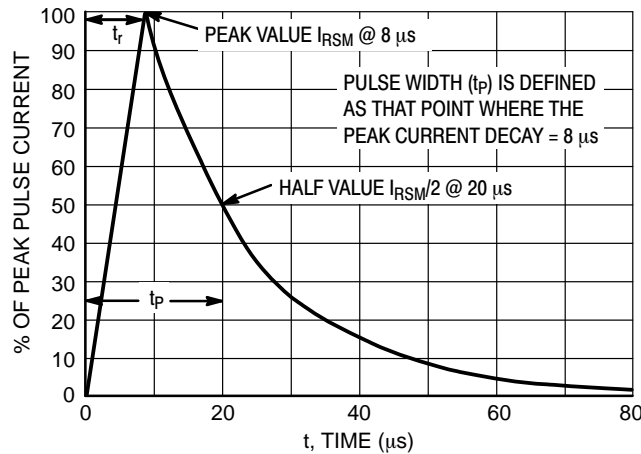

Figure 7. 8 X 20 μs Pulse Waveform

## MG2040, SZMG2040

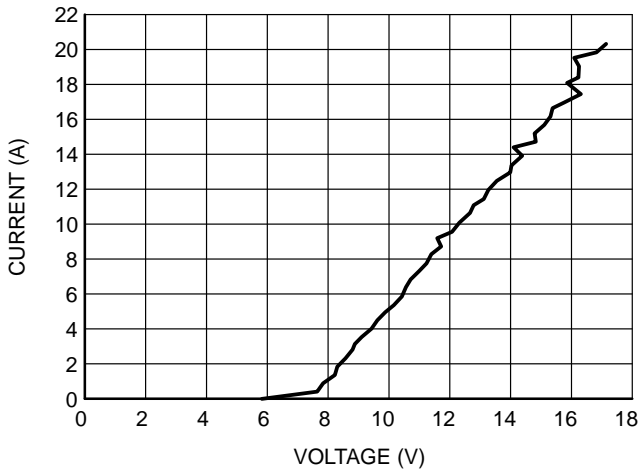

Figure 8. Positive TLP I-V Curve

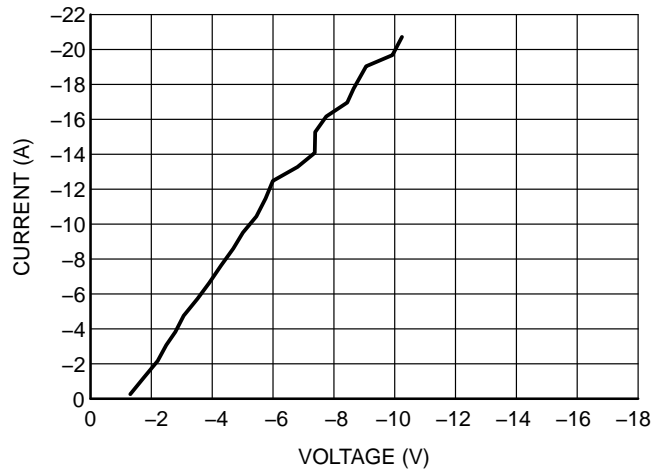

Figure 9. Negative TLP I-V Curve

### Transmission Line Pulse (TLP) Measurement

Transmission Line Pulse (TLP) provides current versus voltage (I-V) curves in which each data point is obtained from a 100 ns long rectangular pulse from a charged transmission line. A simplified schematic of a typical TLP system is shown in Figure 10. TLP I-V curves of ESD protection devices accurately demonstrate the product's ESD capability because the 10s of amps current levels and under 100 ns time scale match those of an ESD event. This is illustrated in Figure 11 where an 8 kV IEC 61000-4-2 current waveform is compared with TLP current pulses at 8 A and 16 A. A TLP I-V curve shows the voltage at which the device turns on as well as how well the device clamps voltage over a range of current levels.

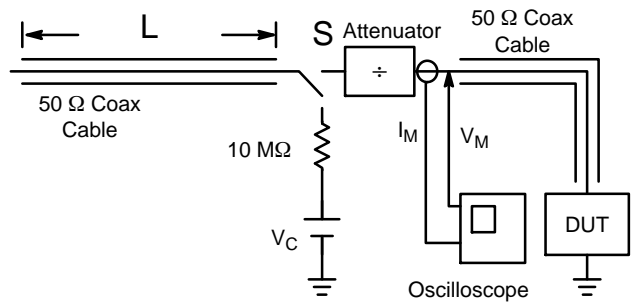

Figure 10. Simplified Schematic of a Typical TLP System

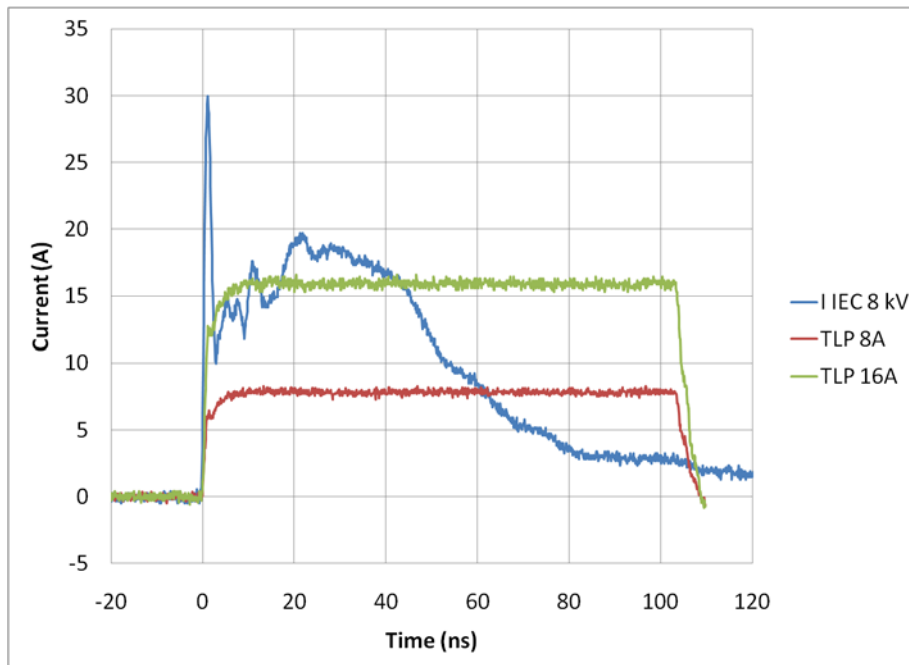
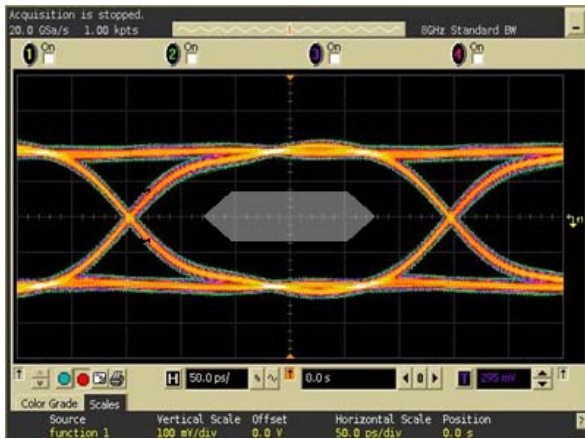
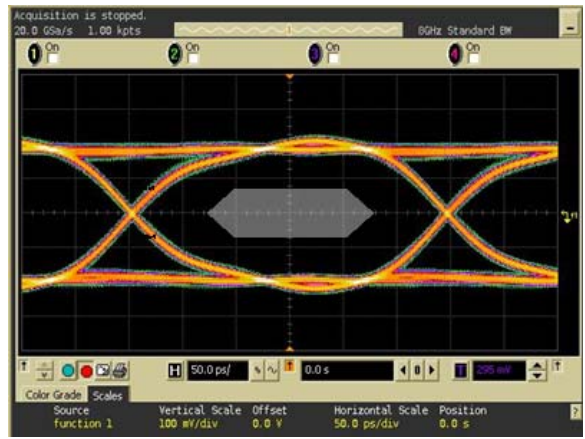

Figure 11. Comparison Between 8 kV IEC 61000-4-2 and 8 A and 16 A TLP Waveforms

# MG2040, SZMG2040



Without ESD



With MG2040

Figure 12. HDMI1.4 Eye Diagram with and without MG2040. 3.4 Gb/s, 400 mV<sub>pp</sub>

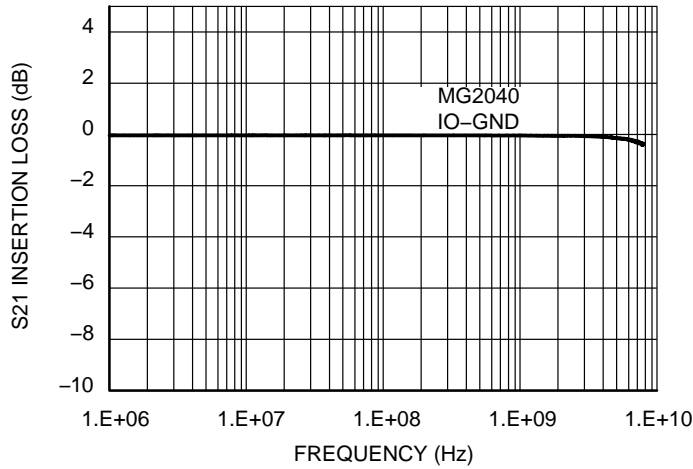

Figure 13. MG2040 Insertion Loss

# MG2040, SZMG2040

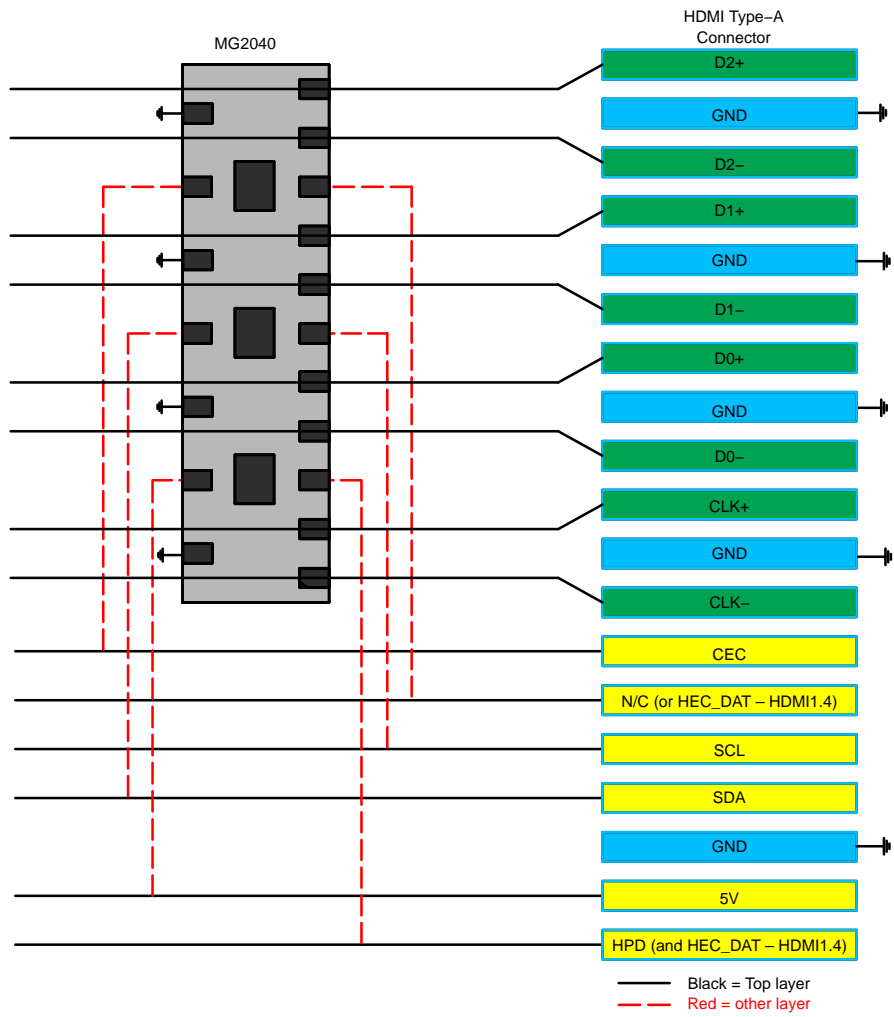
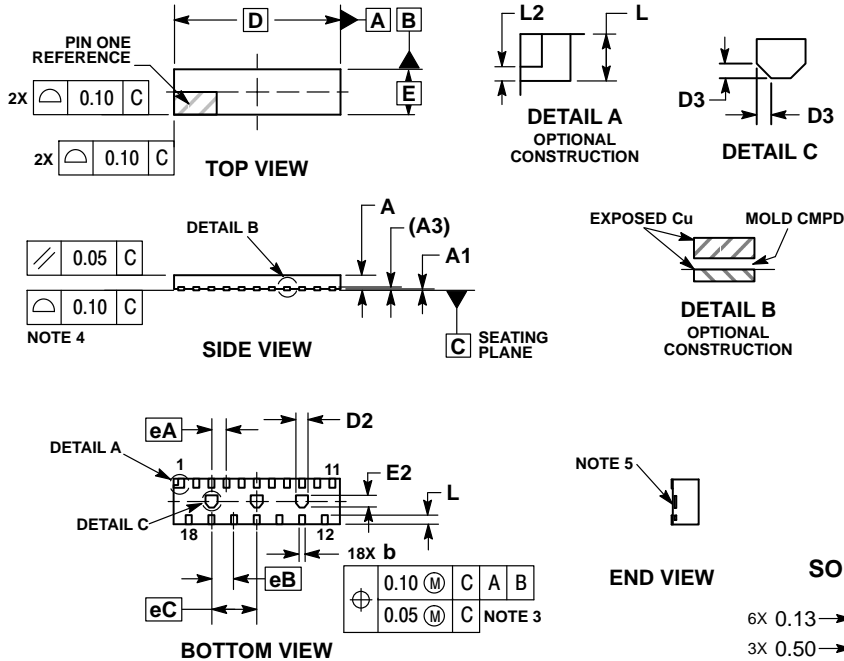

Figure 14. HDMI Layout Diagram

# MG2040, SZMG2040

## PACKAGE DIMENSIONS

UDFN18, 5.5x1.5, 0.5P/0.75P  
CASE 517CP  
ISSUE A



### NOTES:

1. DIMENSIONING AND TOLERANCING PER ASME Y14.5M, 1994.
2. CONTROLLING DIMENSION: MILLIMETERS.
3. DIMENSION b APPLIES TO PLATED TERMINAL AND IS MEASURED BETWEEN 0.10 AND 0.20 MM FROM TERMINAL TIP.
4. COPLANARITY APPLIES TO THE EXPOSED PAD AS WELL AS THE TERMINALS.
5. EXPOSED ENDS OF TERMINALS ARE ELECTRICALLY ACTIVE.

MILLIMETERS		
DIM	MIN	MAX
A	0.45	0.55
A1	0.00	0.05
A3	0.13	REF
b	0.15	0.25
D	5.50	BSC
D2	0.35	0.45
D3	0.10	REF
E	1.50	BSC
E2	0.35	0.45
eA	0.50	BSC
eB	0.75	BSC
eC	1.50	BSC
L	0.20	0.40
L2	0.10	REF

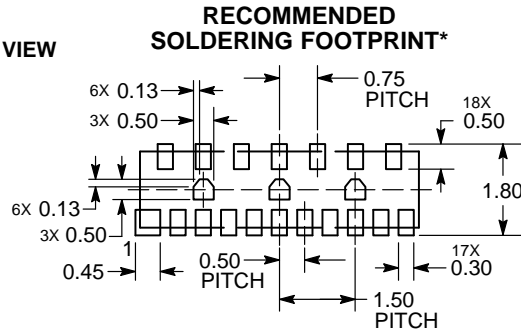

NOTE: CENTER PADS OPTIONAL DIMENSION: MILLIMETERS

\*For additional information on our Pb-Free strategy and soldering details, please download the ON Semiconductor Soldering and Mounting Techniques Reference Manual, SOLDERRM/D.

ON Semiconductor and are registered trademarks of Semiconductor Components Industries, LLC (SCILLC). SCILLC reserves the right to make changes without further notice to any products herein. SCILLC makes no warranty, representation or guarantee regarding the suitability of its products for any particular purpose, nor does SCILLC assume any liability arising out of the application or use of any product or circuit, and specifically disclaims any and all liability, including without limitation special, consequential or incidental damages. "Typical" parameters which may be provided in SCILLC data sheets and/or specifications can and do vary in different applications and actual performance may vary over time. All operating parameters, including "Typicals" must be validated for each customer application by customer's technical experts. SCILLC does not convey any license under its patent rights nor the rights of others. SCILLC products are not designed, intended, or authorized for use as components in systems intended for surgical implant into the body, or other applications intended to support or sustain life, or for any other application in which the failure of the SCILLC product could create a situation where personal injury or death may occur. Should Buyer purchase or use SCILLC products for any such unintended or unauthorized application, Buyer shall indemnify and hold SCILLC and its officers, employees, subsidiaries, affiliates, and distributors harmless against all claims, costs, damages, and expenses, and reasonable attorney fees arising out of, directly or indirectly, any claim of personal injury or death associated with such unintended or unauthorized use, even if such claim alleges that SCILLC was negligent regarding the design or manufacture of the part. SCILLC is an Equal Opportunity/Affirmative Action Employer. This literature is subject to all applicable copyright laws and is not for resale in any manner.

### PUBLICATION ORDERING INFORMATION

#### LITERATURE FULFILLMENT:

Literature Distribution Center for ON Semiconductor  
P.O. Box 5163, Denver, Colorado 80217 USA  
Phone: 303-675-2175 or 800-344-3860 Toll Free USA/Canada  
Fax: 303-675-2176 or 800-344-3867 Toll Free USA/Canada  
Email: orderlit@onsemi.com

N. American Technical Support: 800-282-9855 Toll Free  
USA/Canada  
Europe, Middle East and Africa Technical Support:  
Phone: 421 33 790 2910  
Japan Customer Focus Center  
Phone: 81-3-5817-1050

ON Semiconductor Website: [www.onsemi.com](http://www.onsemi.com)

Order Literature: <http://www.onsemi.com/orderlit>

For additional information, please contact your local Sales Representative