

LOC		DIST		REVISIONS			
P	LTN	DESCRIPTION	DATE	DWN	APVD		
B		REVISED PER ECR-16-001597	22JUL2016	BW	GJ		

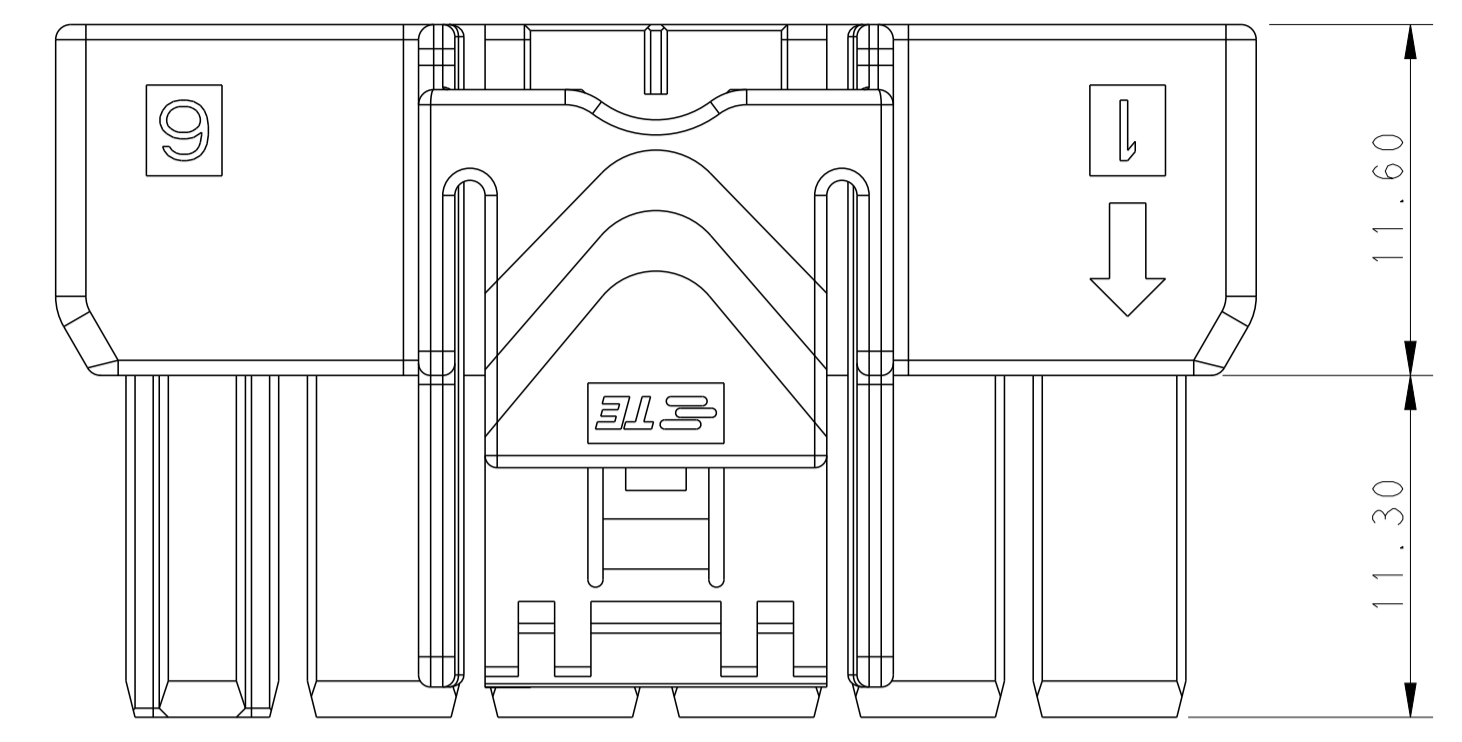

POS.	DIM. A
2*6	39.70
2*5	33.70
2*4	27.70
2*3	21.70

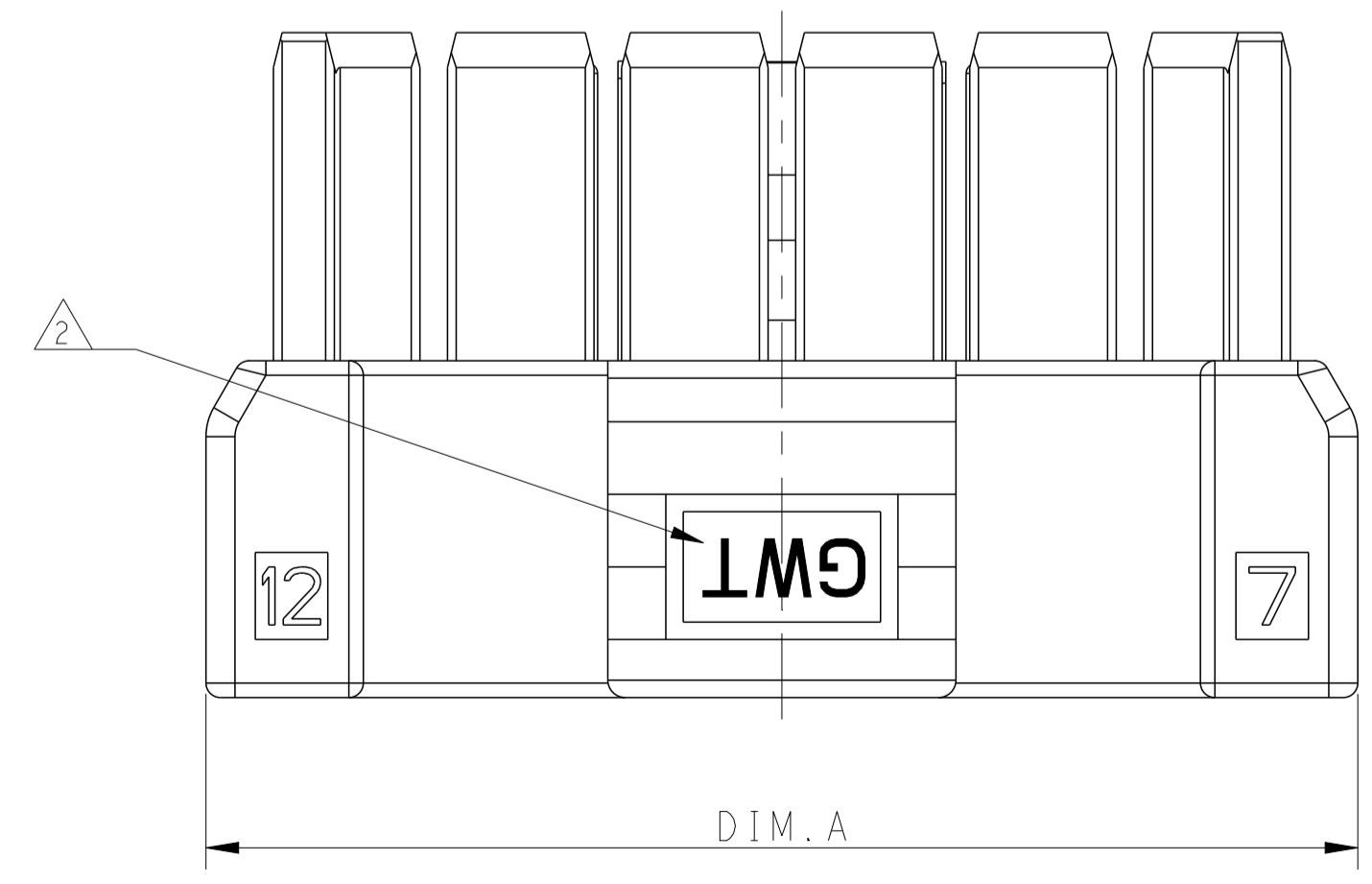
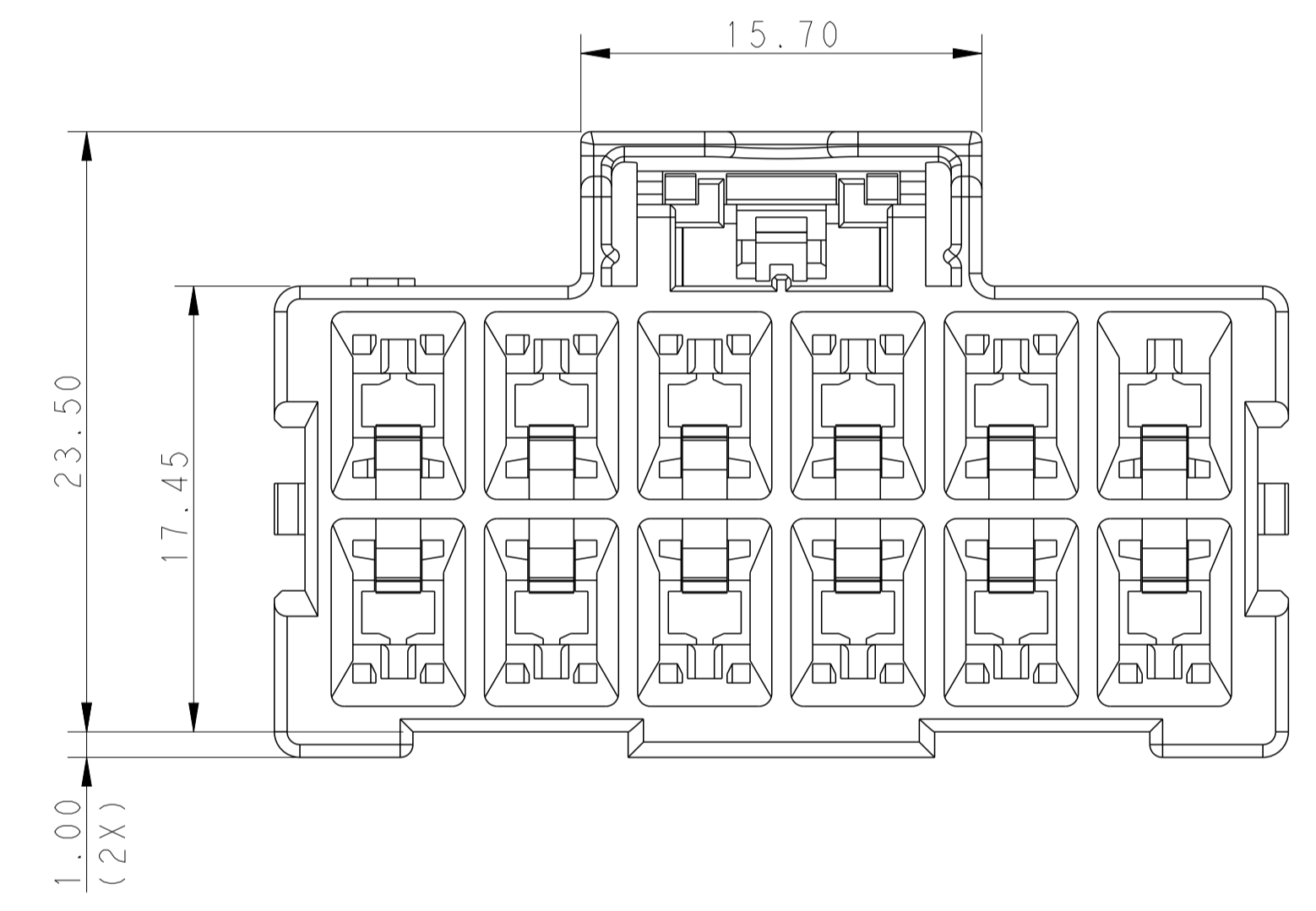
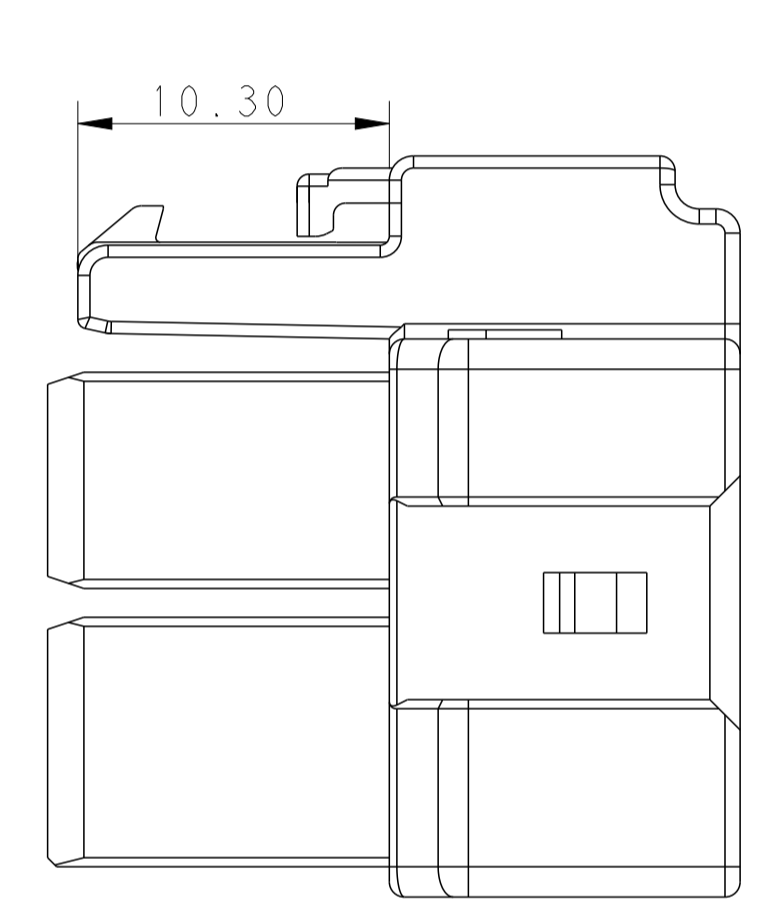
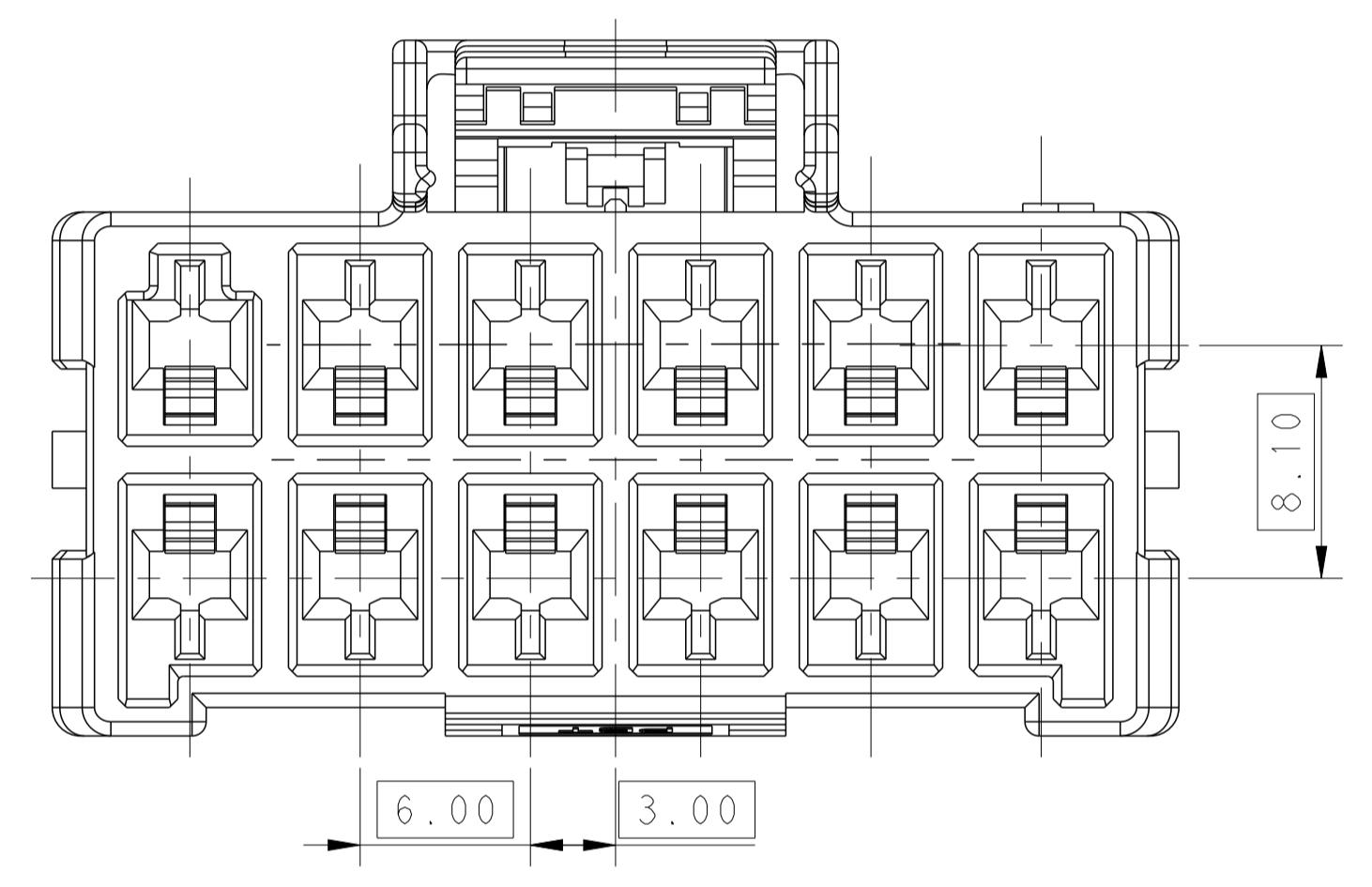

NOTE

- MATERIAL:
 - LEVEL A: PA6, COMPLY WITH GLOW WIRE REQUIREMENTS FOR PARTS OF NON-METALLIC MATERIAL SUPPORTING A CURRENT-CARRYING CONNECTION DETAILED IN IEC 60335-1, SECTION 30 (GWT), UL 94V-0
 - LEVEL B: PBT, HOT WIRE IGNITION (HWI) VERSION ARE MOLDED IN A RESIN THAT COMPLIES WITH TE HOT WIRE IGNITION TEST 109-32026 AND ARE RECOMMENDED FOR USE WITH HWI HOUSINGS THAT ALSO COMPLY, UL 94V-0

- MATERIAL MARK:
 - LEVEL A:GWT,LEVEL B:HWT

- APPLICABLE CONTACT P/N
 RECEPTACLE CONTACT:1971237/1971779/81/83/85/87-*,2238066-*

- MATING CONN, P/N
 CAP HSG: *-2232359/264-
 TPA: *-1971778-*

5. This product has not completed validation testing.

THIS DRAWING IS A CONTROLLED DOCUMENT.		DWG	TOMMY WU	26MAR2013	TE Connectivity PLUG HOUSING, DOUBLE ROW POWER TRIPLE LOCK
DIMENSIONS:		CHK	HAPYE WU	26MAR2013	
TOLERANCES UNLESS OTHERWISE SPECIFIED:		APVD	YIHONG MAO	26MAR2013	
mm		NAME		108-106118	
0 PLC ±		PRODUCT SPEC		114-106118	
1 PLC ±0.35		APPLICATION SPEC		114-106118	
2 PLC ±0.25		SIZE		A1	
3 PLC ±		CAGE CODE		00779	
4 PLC ±		DRAWING NO		C=2232266	
ANGLES ±		RESTRICTED TO			
FINISH		WEIGHT			
MATERIAL		Customer Drawing		SCALE	
		SHEET		1 OF 2	
		REV		B	

LOC		DIST		REVISIONS			
P	LTN	DESCRIPTION	DATE	DNW	APVD		
-	-	SEE SHEET 1	-	-	-		

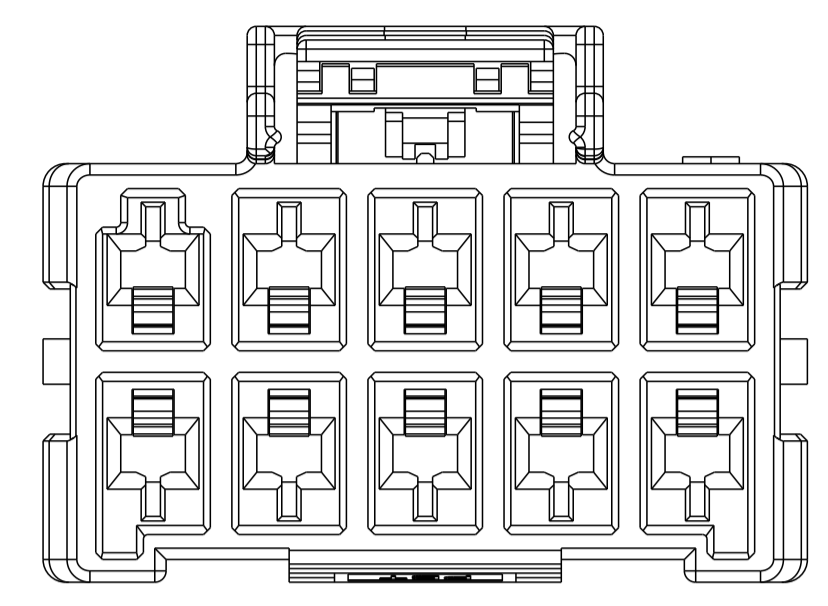
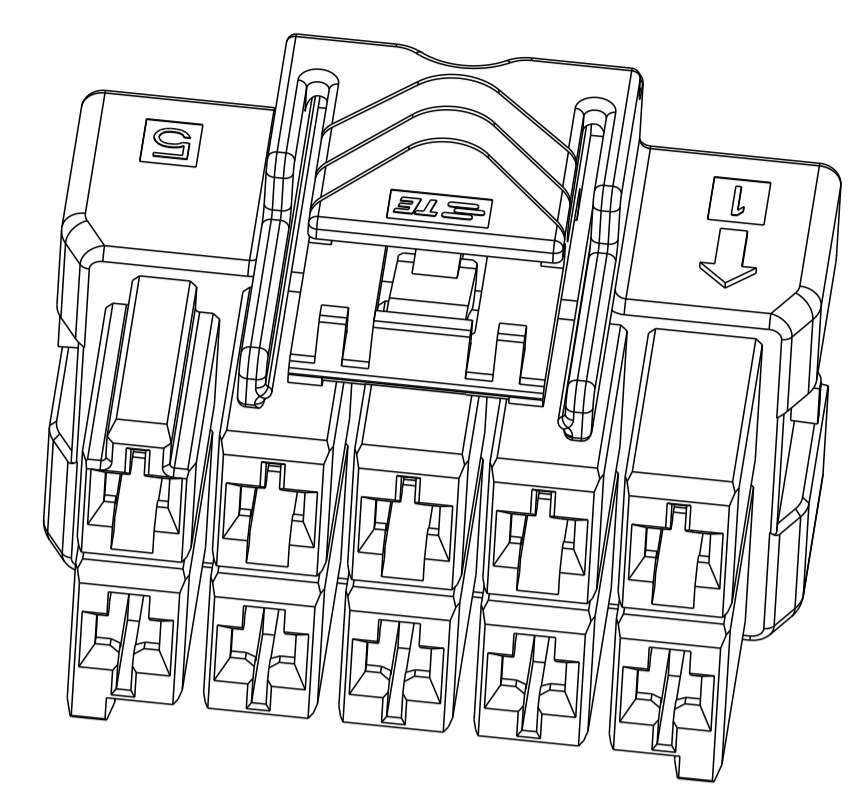

2*5 POSITIONS

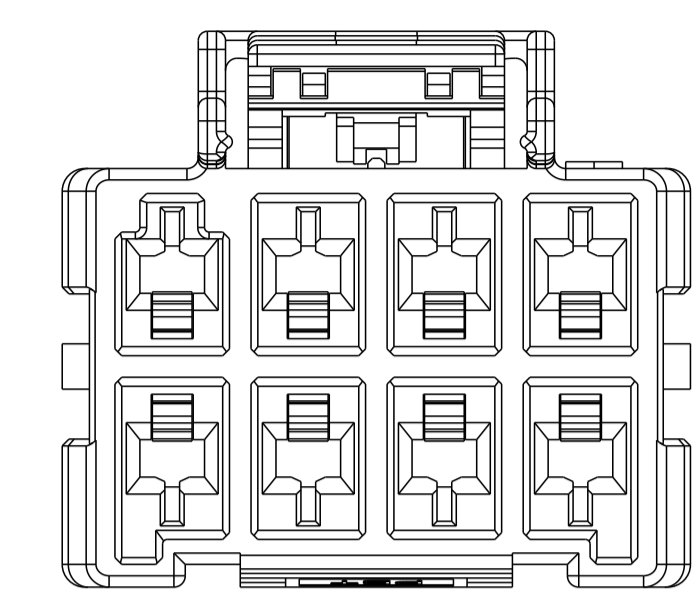
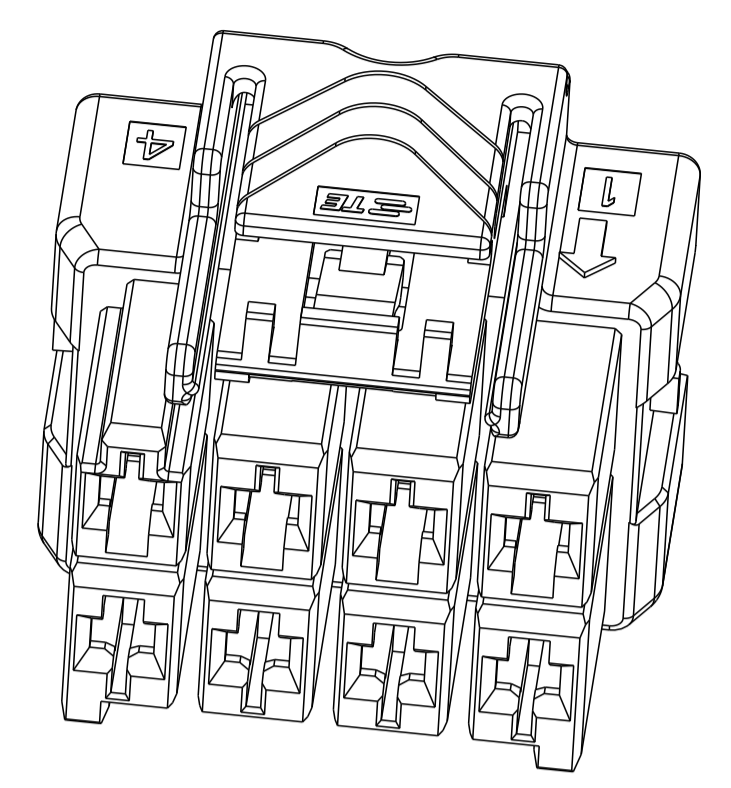

2*4 POSITIONS

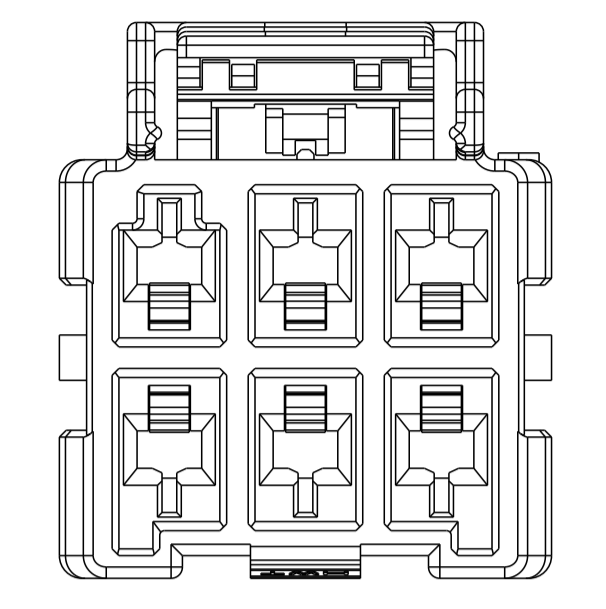
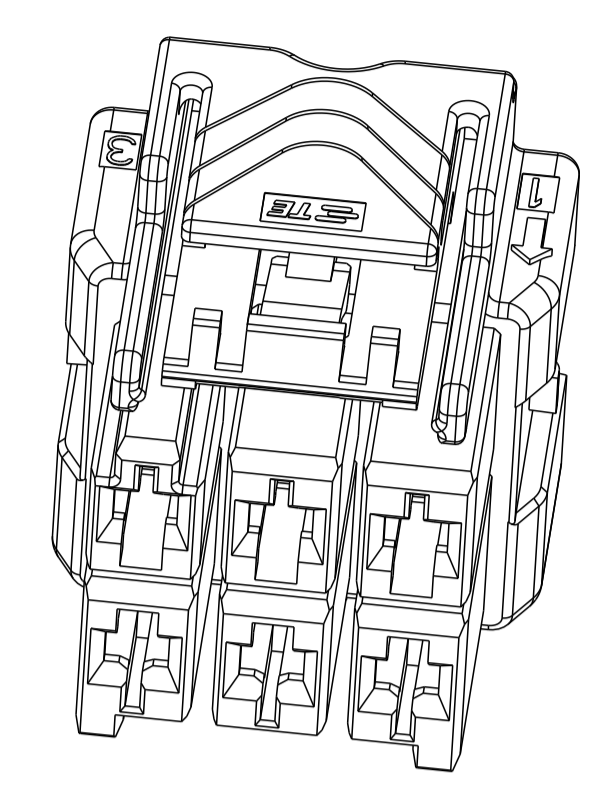

2*3 POSITIONS

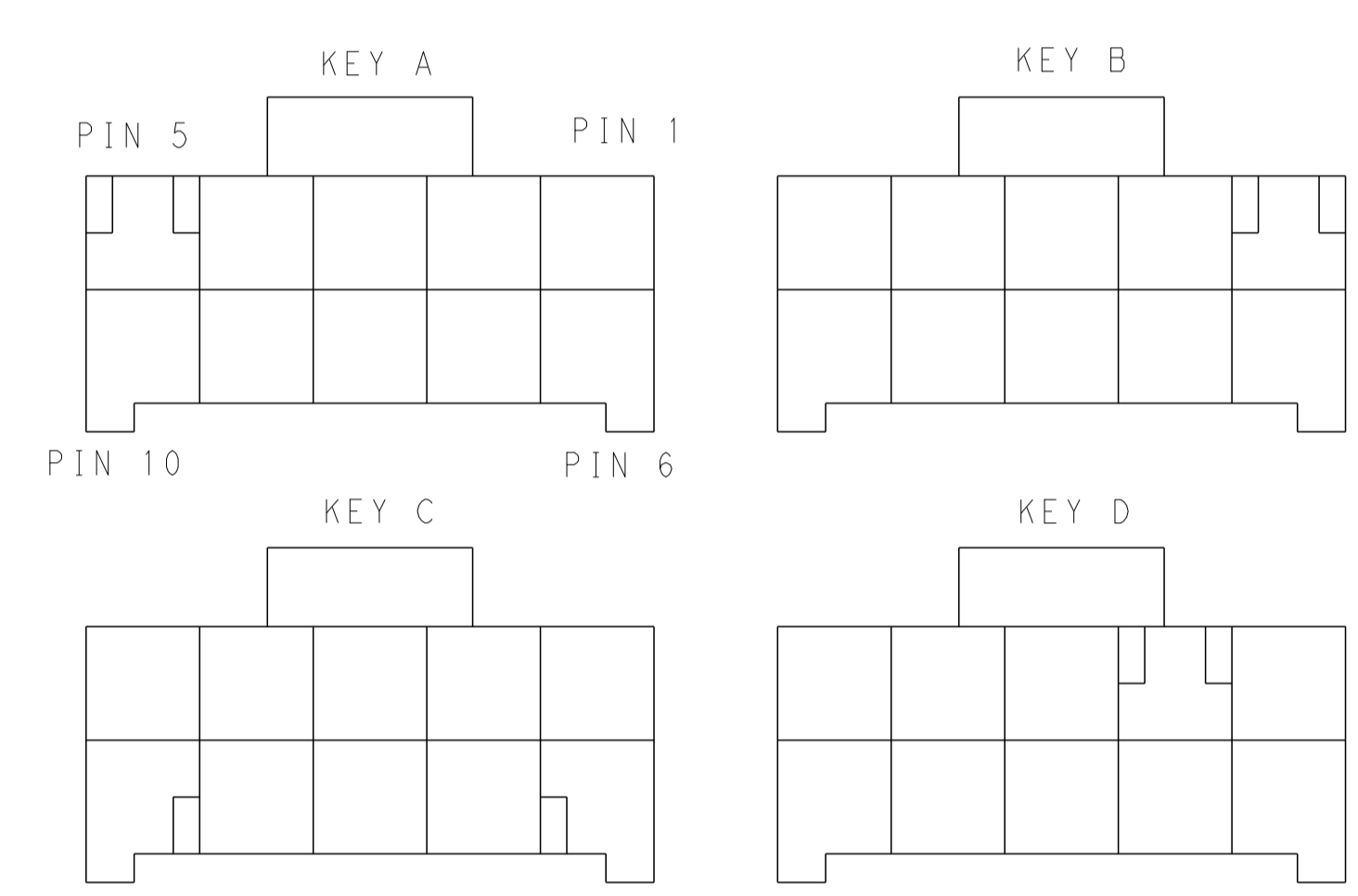

KEYING FOR 2*5 POS.

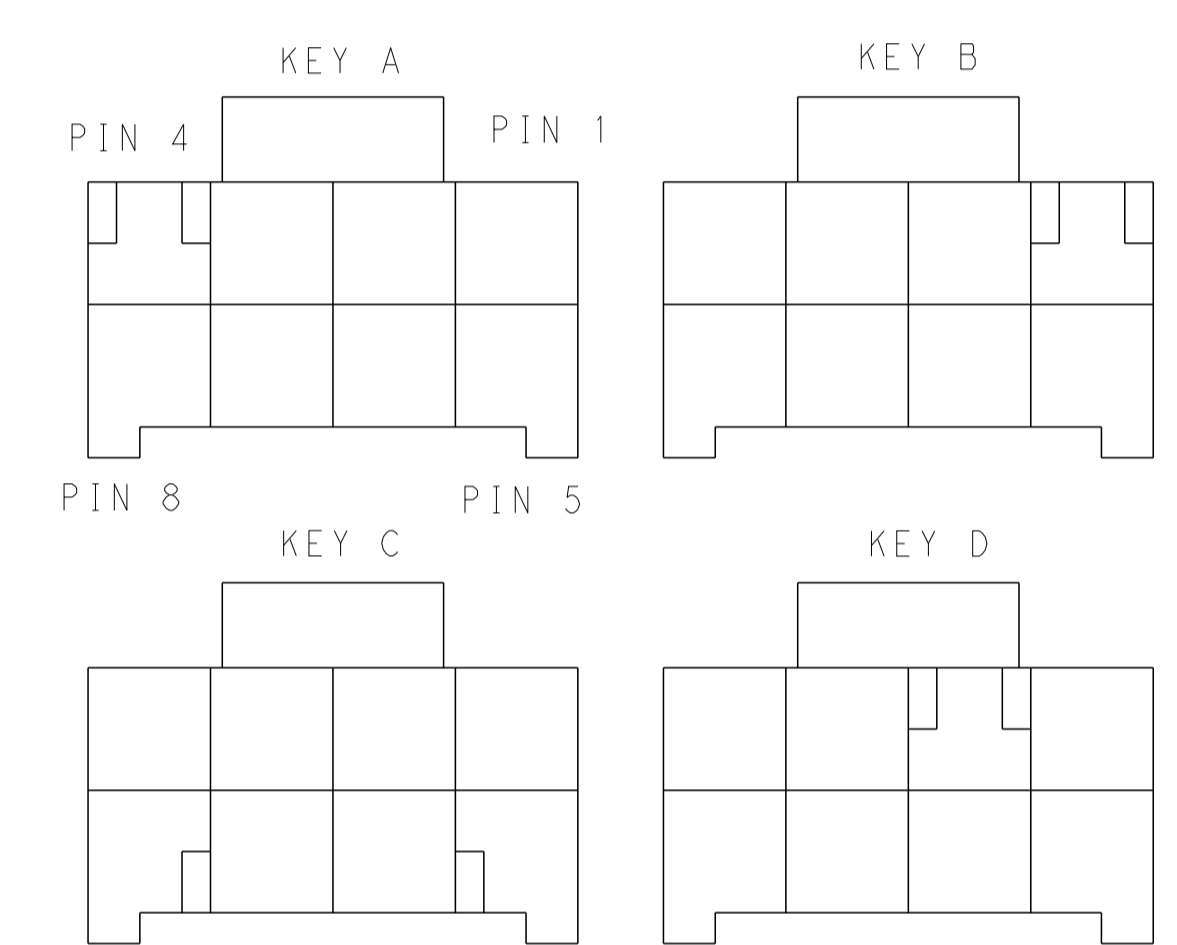

KEYING FOR 2*4 POS.

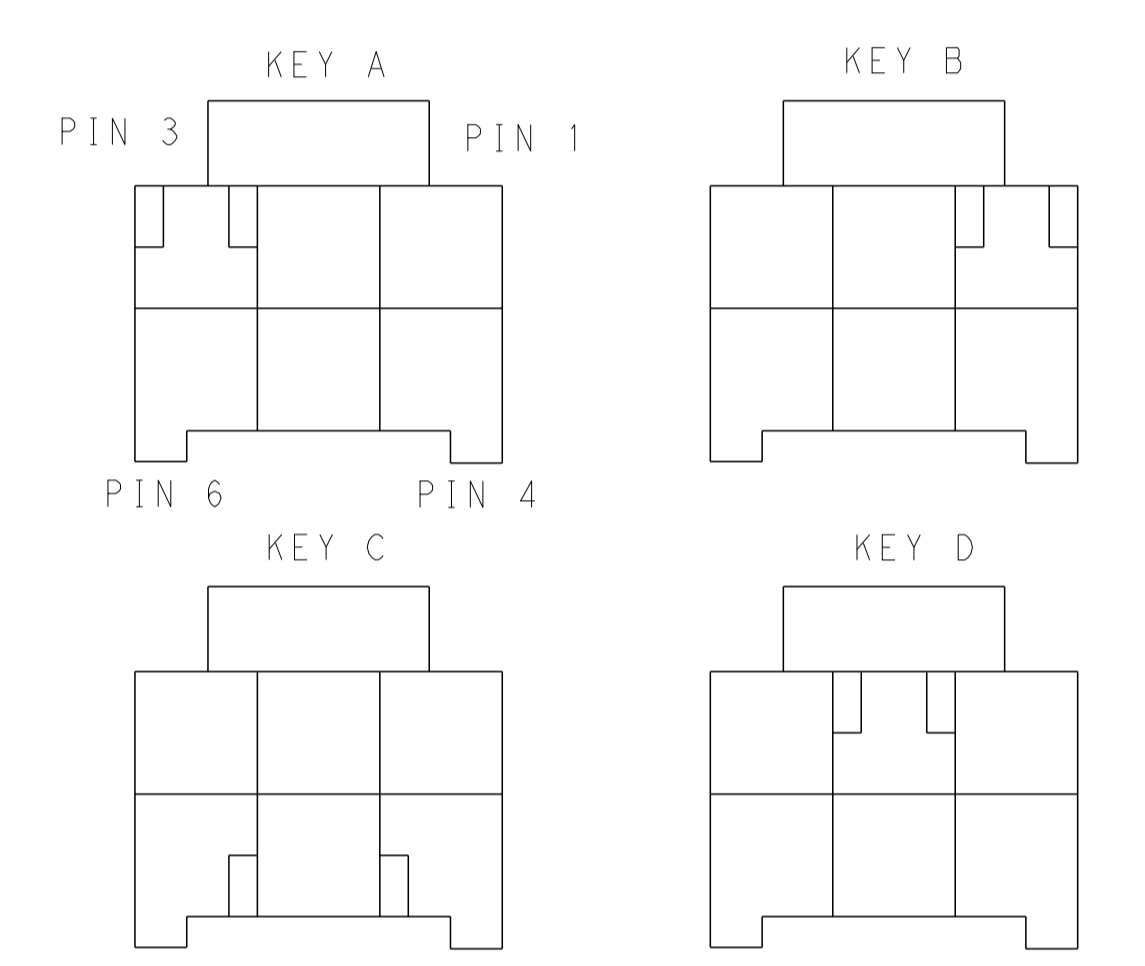

KEYING FOR 2*3 POS.

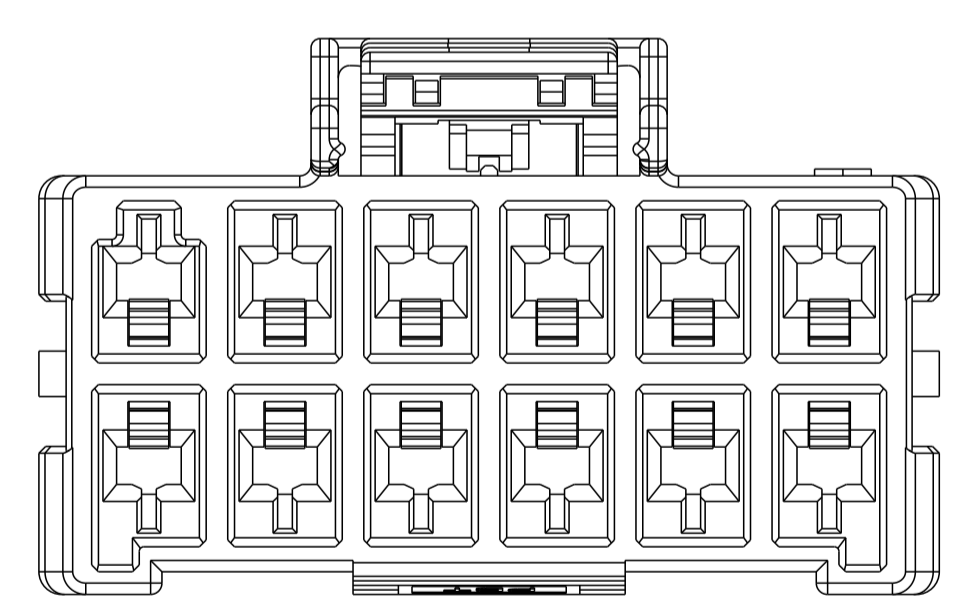
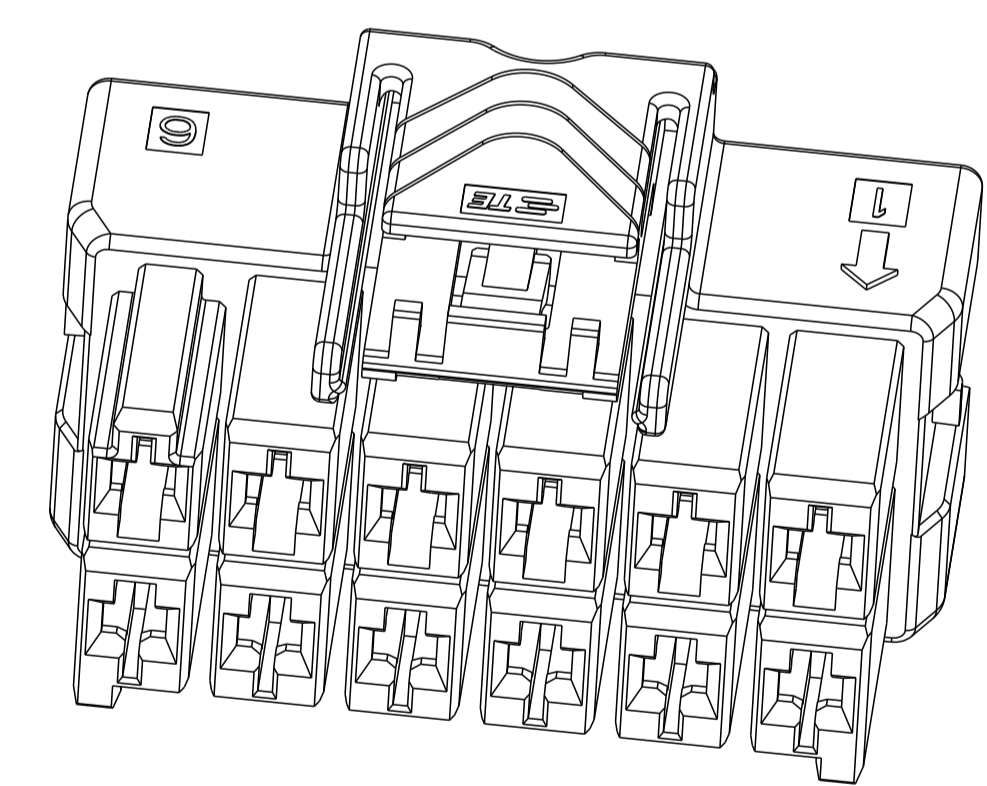

2*6 POSITIONS

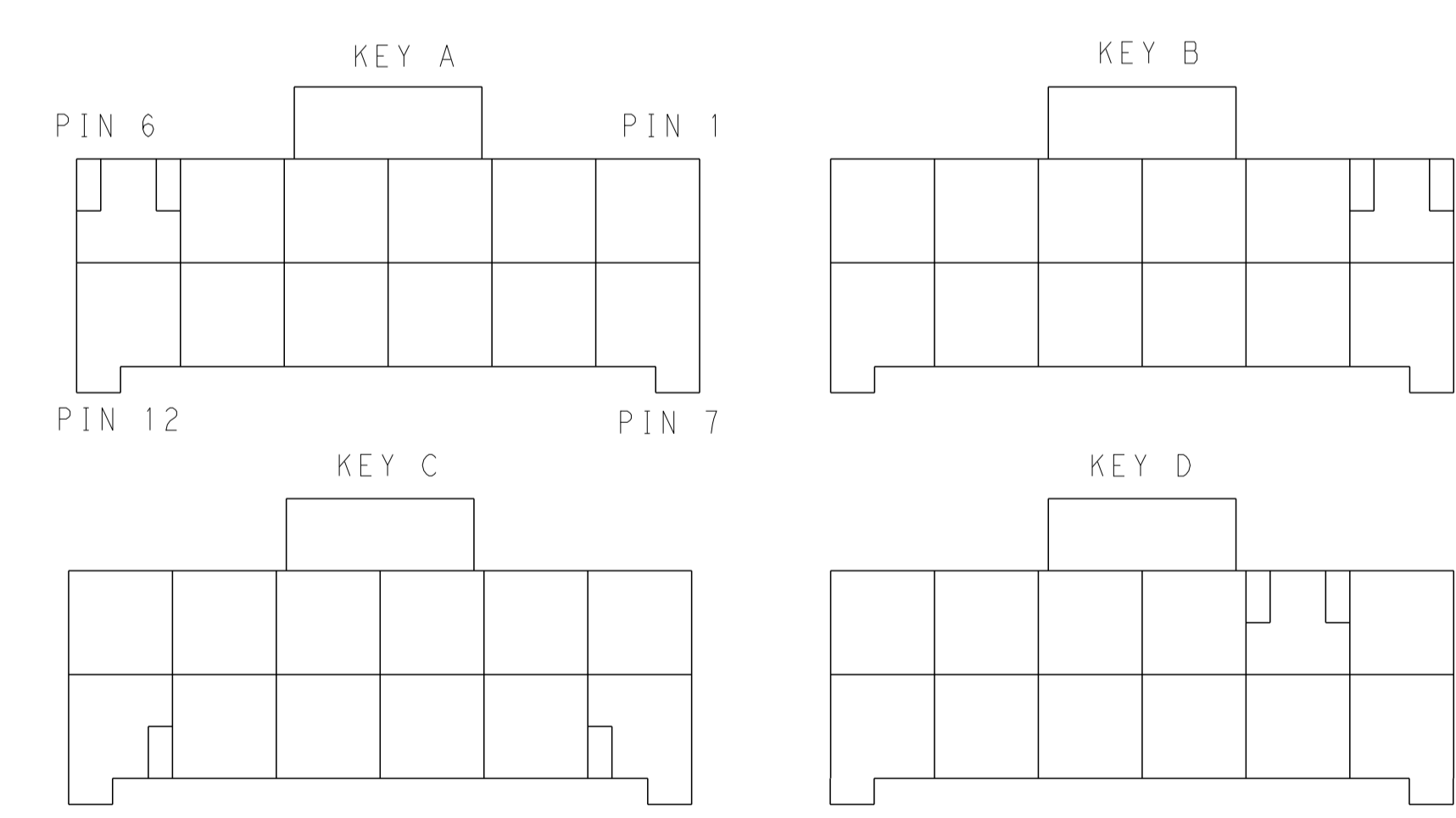

KEYING FOR 2*6 POS.

POS.	MATERIAL	COLOR	KEY	P/N
2*6	LEVEL A	DARK GREY	KEY A	5-2232266-6
		BROWN	KEY B	6-2232266-6
		GREEN	KEY C	7-2232266-6
		ORANGE	KEY D	8-2232266-6
2*5	LEVEL A	DARK GREY	KEY A	5-2232266-5
		BROWN	KEY B	6-2232266-5
		GREEN	KEY C	7-2232266-5
		ORANGE	KEY D	8-2232266-5

POS.	MATERIAL	COLOR	KEY	P/N
2*4	LEVEL A	DARK GREY	KEY A	5-2232266-4
		BROWN	KEY B	6-2232266-4
		GREEN	KEY C	7-2232266-4
		ORANGE	KEY D	8-2232266-4
2*3	LEVEL A	DARK GREY	KEY A	5-2232266-3
		BROWN	KEY B	6-2232266-3
		GREEN	KEY C	7-2232266-3
		ORANGE	KEY D	8-2232266-3
LEVEL B	BLACK	KEY A	1-2232266-1	

THIS DRAWING IS A CONTROLLED DOCUMENT.

DWN: TOMMY_WU 26MAR2013
 CHK: TOMMY_WU 26MAR2013
 APVD: HAPYE_WU 26MAR2013
 YIHONG_MAO 26MAR2013

STE TE Connectivity
 PLUG HOUSING, DOUBLE ROW
 POWER TRIPLE LOCK

DIMENSIONS: mm
 TOLERANCES UNLESS OTHERWISE SPECIFIED:
 0 PLC ±
 1 PLC ±0.35
 2 PLC ±0.25
 3 PLC ±
 4 PLC ±
 ANGLES ±
 FINISH ±

MATERIAL: -
 WEIGHT: -
 Customer Drawing

SIZE: A1
 CAGE CODE: 100779
 DRAWING NO: C=2232266
 RESTRICTED TO: -
 SCALE: - SHEET 2 OF 2 REV B