

C3216X7R2A104K160AE

TDK Item Description : C3216X7R2A104KT***S



Application & Main Feature

Commercial Grade (Soft Termination)

Series

C3216 [EIA CC1206]

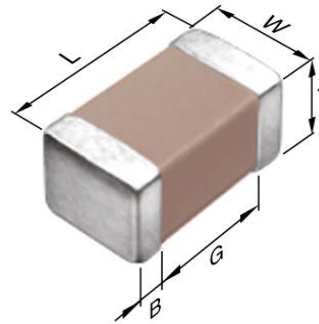

Dimensions

L	3.20mm +0.4,-0.2mm
W	1.60mm +0.3,-0.2mm
T	1.60mm +0.3,-0.2mm
B	0.20mm Min.
G	1.00mm Min.

Temperature Characteristic

X7R (-55 to 125 degC +/-15%)

Rated Voltage

2A (100Vdc)

Capacitance

100nF

Capacitance Tolerance

K (+/-10%)

Dissipation Factor

3% Max.

Insulation Resistance

5Gohm Min

AEC-Q200

Not Applicable

|Z|, ESR vs. Freq. Characteristics (Simulation Data)

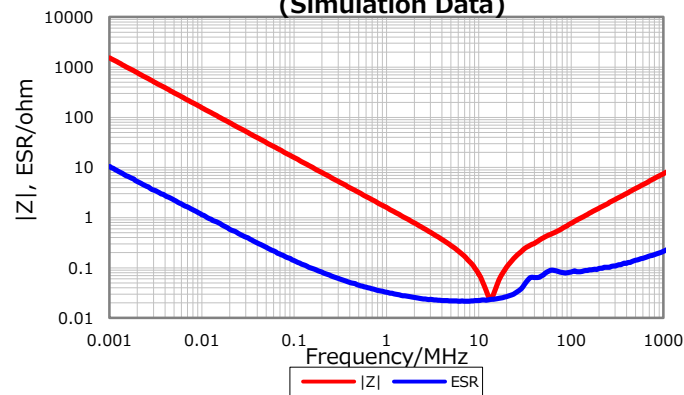

Cap. vs. Freq. Characteristic

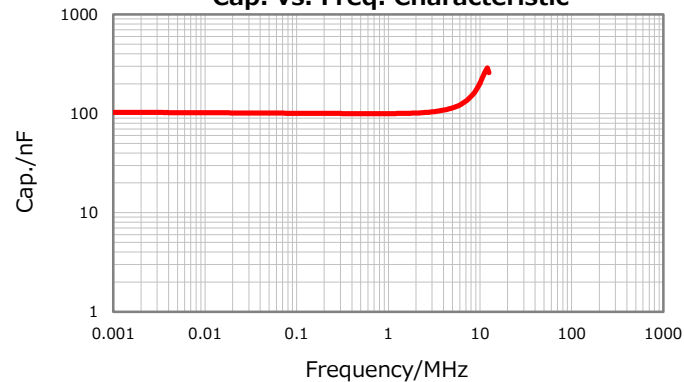

DC Bias Characteristic

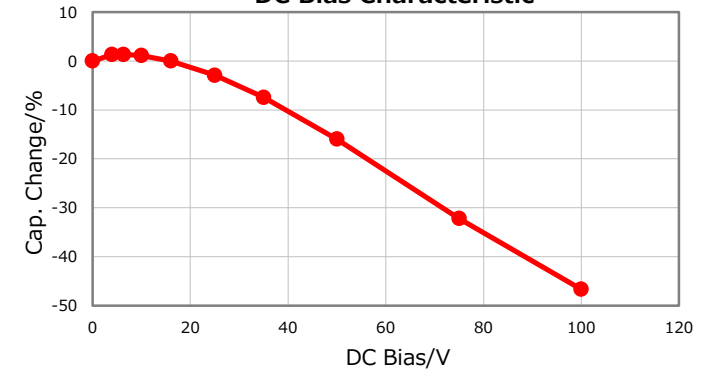

Temperature Characteristics

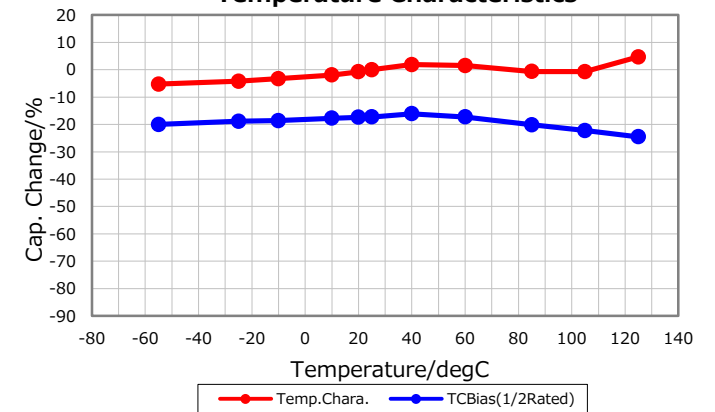

Ripple Temperature Rise Characteristics

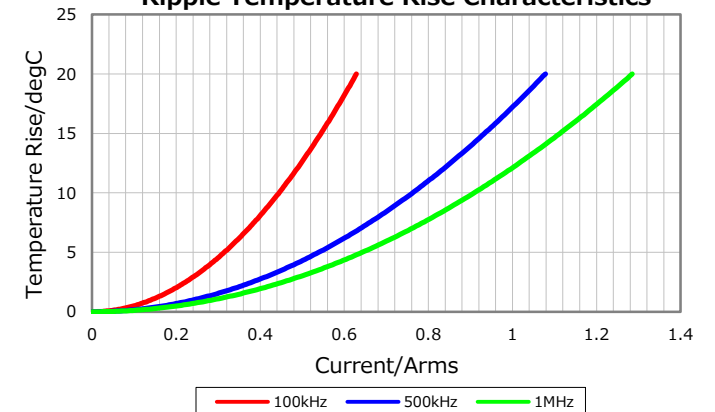

Characterization Sheet (Multilayer Ceramic Chip Capacitors)



All specifications are subject to change without notice.

March 16, 2017