



### Typical Applications

The HMC910LC4B is ideal for:

- Synchronization of clock and data
- Transponder design
- Serial Data Transmission up to 32 Gbps
- Broadband Test & Measurement
- RF ATE Applications

### Features

- Very Wide Bandwidth: DC - 24 GHz
- Continuous Adjustable Delay Range: 70 ps
- Single-Ended or Differential Operation
- Adjustable Differential Output Voltage Swing: 170 - 760 mVp-p @ 24 GHz
- Delay Control Modulation Bandwidth: 10 MHz
- Single Supply: +3.3V
- 24 Lead Ceramic 4x4mm SMT Package: 16mm<sup>2</sup>

### Functional Diagram

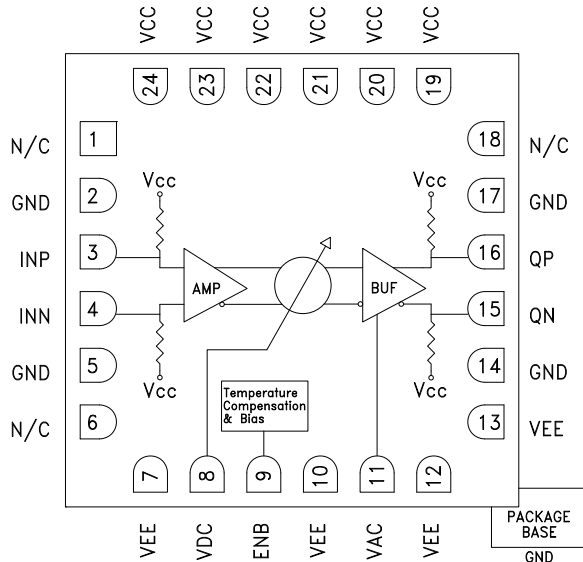

### General Description

The HMC910LC4B is a broadband time delay with 0 to 70 ps continuously adjustable delay range. The delay control is linearly monotonic with respect to the control voltage, VDC and the control input has a modulation bandwidth of 10 MHz. The device provides a differential output voltage with constant amplitude for single-ended or differential input voltages above the input sensitivity level, while the output voltage swing may be adjusted using the VAC control pin. The HMC910LC4B features internal temperature compensation and bias circuitry to minimize delay variations with temperature. The device also features an enable pin, ENB. All RF input and outputs of the HMC910LC4B are internally terminated with 50 Ohms to Vcc, and may either be AC or DC coupled. Output pins can be connected directly to a 50 Ohm to Vcc terminated system, while DC blocking capacitors must be used if the terminated system input is 50 Ohms to a DC voltage other than Vcc.

### Electrical Specifications, $T_A = +25^\circ C$ , $V_{cc} = 3.3V$ , $V_{ee} = 0V$ , $GND = 0V$

Parameter	Conditions	Min.	Typ.	Max.	Units
Power Supply Voltage	$\pm \%9$ Tolerance	3	3.3	3.6	V
Power Supply Current	VAC = 2.6V	400	475	550	mA
Time Delay Range	@ 10 GHz	59	62.5		ps
	@ 20 GHz	63	66.5		ps
	@ 24 GHz	67	70.5		ps
Maximum Data Rate		32			Gbps
Maximum Clock Frequency		24			GHz
Delay Control Modulation Bandwidth			10		MHz
Delay Control Voltage (VDC)		1.1		2.3	V
Output Amplitude Control Voltage (VAC)		1.7	2.6	2.7	V

Information furnished by Analog Devices is believed to be accurate and reliable. However, no responsibility is assumed by Analog Devices for its use, nor for any infringements of patents or other rights of third parties that may result from its use. Specifications subject to change without notice. No license is granted by implication or otherwise under any patent or patent rights of Analog Devices. Trademarks and registered trademarks are the property of their respective owners.

For price, delivery, and to place orders: Analog Devices, Inc., One Technology Way, P.O. Box 9106, Norwood, MA 02062-9106  
 Phone: 781-329-4700 • Order online at [www.analog.com](http://www.analog.com)  
 Application Support: Phone: 1-800-ANALOG-D

# HMC910\* PRODUCT PAGE QUICK LINKS

Last Content Update: 02/23/2017

---

## COMPARABLE PARTS

View a parametric search of comparable parts.

## EVALUATION KITS

- HMC910LC4B Evaluation Board

## DOCUMENTATION

### Data Sheet

- HMC910 Data Sheet

## REFERENCE MATERIALS

### Quality Documentation

- Package/Assembly Qualification Test Report: LC4, LC4B (QTR: 2014-00380 REV: 01)
- Semiconductor Qualification Test Report: BiCMOS-C (QTR: 2013-00241)

## DESIGN RESOURCES

- HMC910 Material Declaration
- PCN-PDN Information
- Quality And Reliability
- Symbols and Footprints

## DISCUSSIONS

View all HMC910 EngineerZone Discussions.

## SAMPLE AND BUY

Visit the product page to see pricing options.

## TECHNICAL SUPPORT

Submit a technical question or find your regional support number.

## DOCUMENT FEEDBACK

Submit feedback for this data sheet.

---



## BROADBAND ANALOG TIME DELAY, DC - 24 GHz

**Electrical Specifications,  $T_A = +25^\circ\text{C}$ ,  $V_{CC} = 3.3\text{V}$ ,  $V_{EE} = 0\text{V}$ ,  $GND = 0\text{V}$  (Continued)**

Parameter	Conditions	Min.	Typ.	Max.	Units
Input Low Voltage	VIL	$V_{CC}-500$	$V_{CC}-200$	$V_{CC}-25$	mV
Input High Voltage	VIH	$V_{CC}+25$	$V_{CC}+200$	$V_{CC}+500$	mV
Input Amplitude	Single-ended, peak-to-peak	50		1000	mVp-p
	Differential, peak-to-peak	100		2000	mVp-p
Output Amplitude	Differential, peak-to-peak @ 10 GHz	210		1020	mVp-p
	Differential, peak-to-peak @ 20 GHz	190		880	mVp-p
	Differential, peak-to-peak @ 24 GHz	170		760	mVp-p
Input Return Loss	frequency < 25 GHz		12		dB
Output Return Loss	frequency < 25 GHz		14		dB
Deterministic Jitter, Jd [1]			6		ps, pp
Additive Random Jitter, Jr	@24 GHz clock input			0.3	ps, rms
Rise Time, tr [1]			14		ps
Fall Time, tf [1]			14		ps
Propagation Delay, td	@20 GHz clock input		360		ps
Time Delay Temperature Sensitivity	@ 20 GHz clock input		-0.03		ps/°C

[1]  $V_{data} = \text{Differential } 300\text{ mVp-p}$ ,  $f_{data} = 22.5\text{ Gbps PRBS } 2^{23}-1\text{ pattern}$

**Time Delay vs. VDC & Frequency [1]**

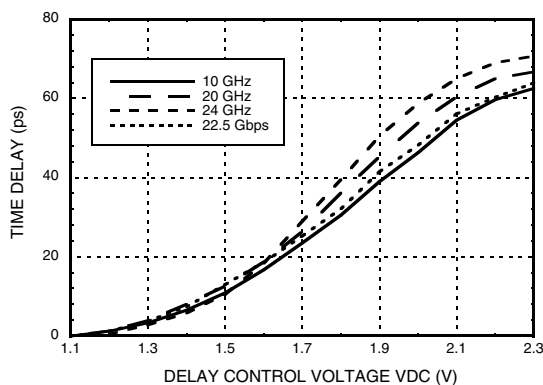

**Time Delay vs. VDC & Supply Voltage [1][2]**

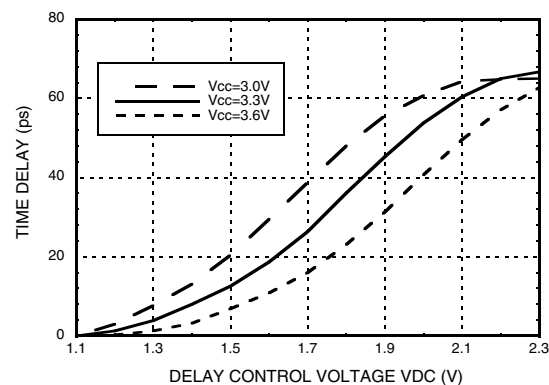

**Time Delay vs. VDC & Temperature [1][2]**

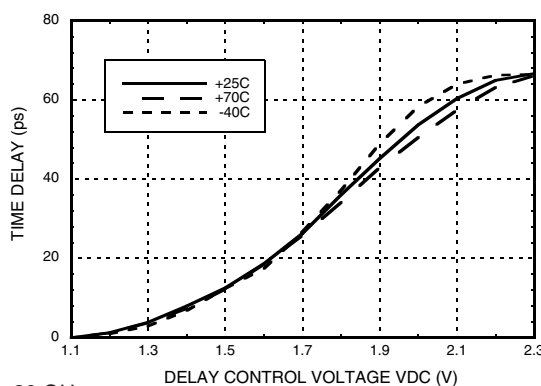

[1] VAC = 2.6V [2] Input Frequency: 20 GHz

Information furnished by Analog Devices is believed to be accurate and reliable. However, no responsibility is assumed by Analog Devices for its use, nor for any infringements of patents or other rights of third parties that may result from its use. Specifications subject to change without notice. No license is granted by implication or otherwise under any patent or patent rights of Analog Devices. Trademarks and registered trademarks are the property of their respective owners.

For price, delivery, and to place orders: Analog Devices, Inc., One Technology Way, P.O. Box 9106, Norwood, MA 02062-9106  
Phone: 781-329-4700 • Order online at [www.analog.com](http://www.analog.com)  
Application Support: Phone: 1-800-ANALOG-D



**BROADBAND ANALOG TIME DELAY, DC - 24 GHz**

**Programmable Max. Time Delay Range vs. Frequency & Temperature [1]**

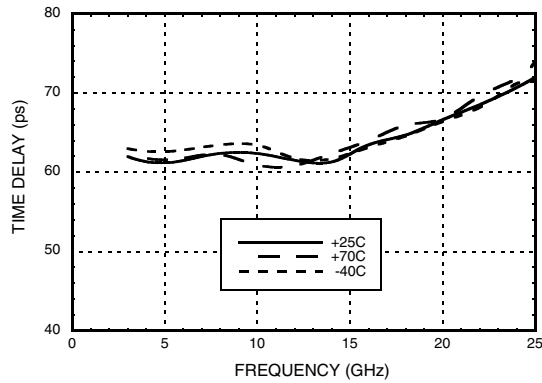

**Programmable Max. Time Delay Range vs. Frequency & Supply Voltage [1]**

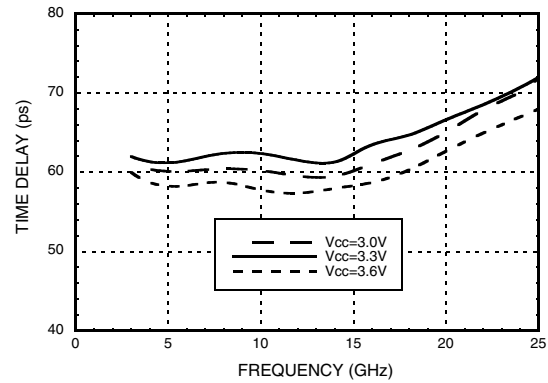

**Differential Output Swing vs. Supply Voltage [1][2][3]**

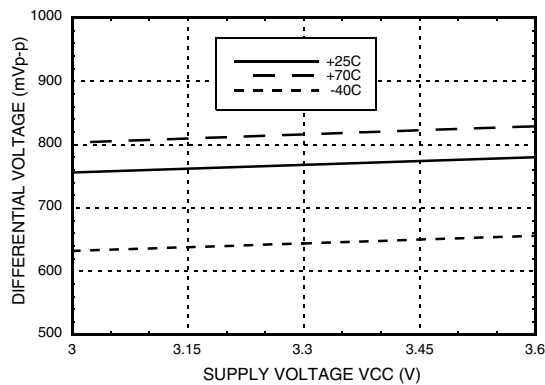

**DC Current vs. Supply Voltage [1][2][3]**

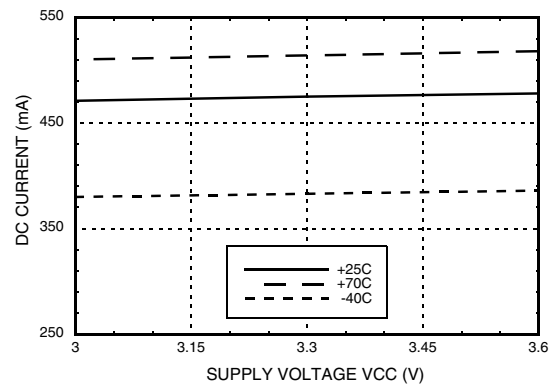

**Differential Output Swing vs. VAC [2][3]**

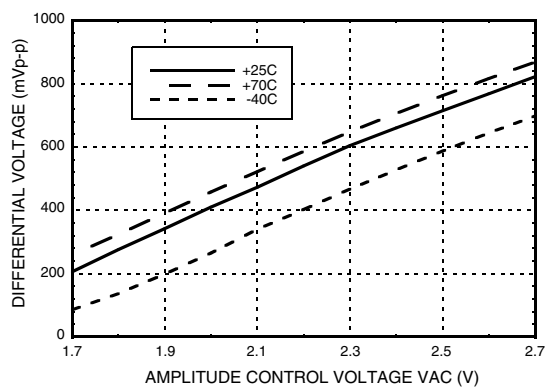

**DC Current vs. VAC [2][3]**

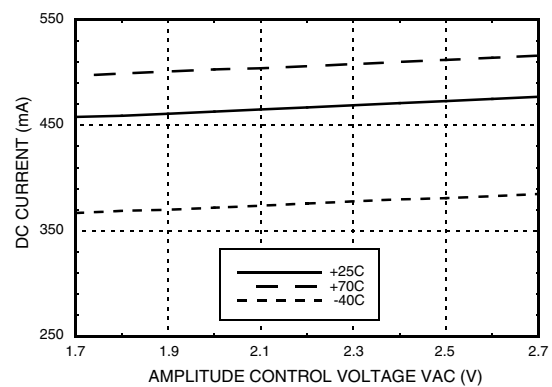

[1] VAC = 2.6V [2] VDC = 1.1V [3] Input Frequency: 20 GHz

Information furnished by Analog Devices is believed to be accurate and reliable. However, no responsibility is assumed by Analog Devices for its use, nor for any infringements of patents or other rights of third parties that may result from its use. Specifications subject to change without notice. No license is granted by implication or otherwise under any patent or patent rights of Analog Devices. Trademarks and registered trademarks are the property of their respective owners.

For price, delivery, and to place orders: Analog Devices, Inc., One Technology Way, P.O. Box 9106, Norwood, MA 02062-9106 Phone: 781-329-4700 • Order online at [www.analog.com](http://www.analog.com) Application Support: Phone: 1-800-ANALOG-D



**BROADBAND ANALOG TIME DELAY, DC - 24 GHz**

**Differential Output Swing vs. Frequency** [1][2]

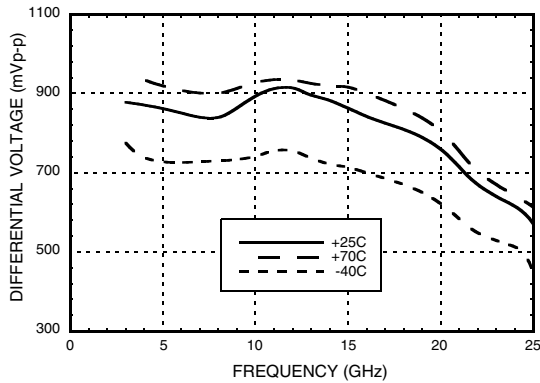

**Peak-to-Peak Jitter vs. VDC** [1][3][4]

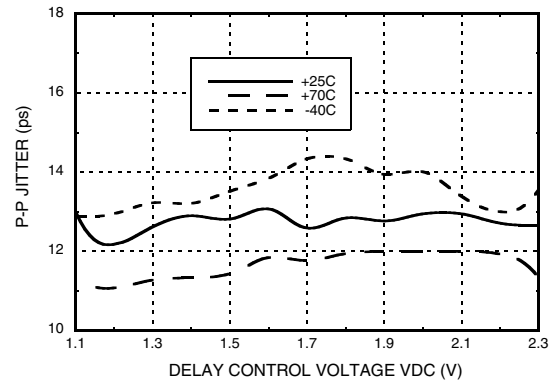

**Rise Time vs. VDC** [1][3]

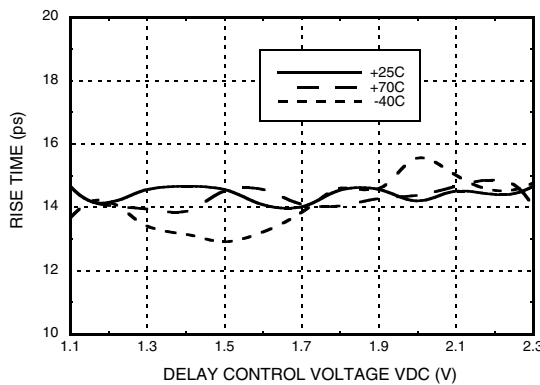

**Fall Time vs. VDC** [1][3]

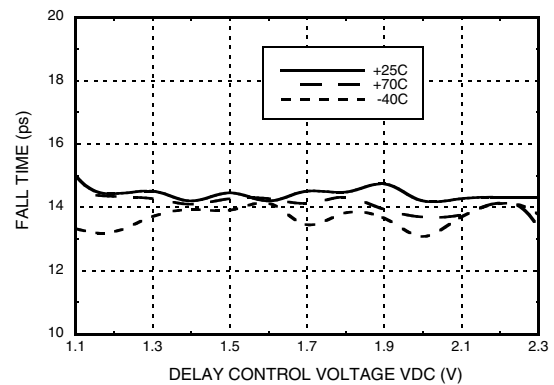

**RMS Jitter vs. VDC & Temperature** [1][5]

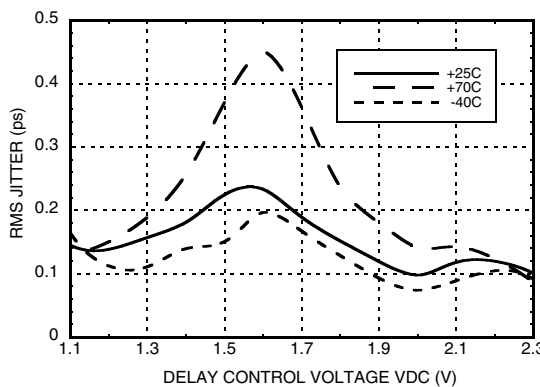

**RMS Jitter vs. VDC & Supply Voltage** [1][5]

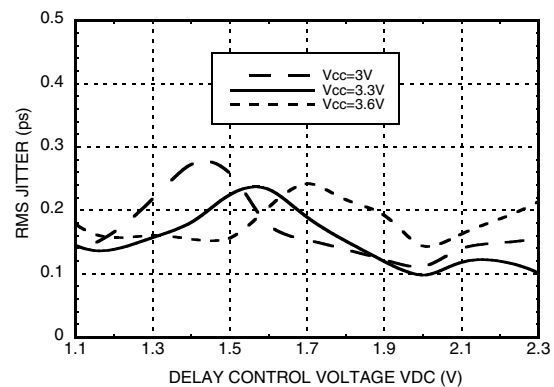

[1] VAC = 2.6V [2] VDC = 1.1V [3] Input data rate: 22.5 Gbps PRBS 2<sup>23</sup>-1 [4] Source jitter was not deembedded

[5] Random jitter is calculated with the formula  $RJ_{added} = \sqrt{[(RJ_{tested})^2 - (RJ_{system})^2]}$  at 24 GHz clock signal



**BROADBAND ANALOG  
TIME DELAY, DC - 24 GHz**

**Return Loss vs. Frequency [1][2][3]**

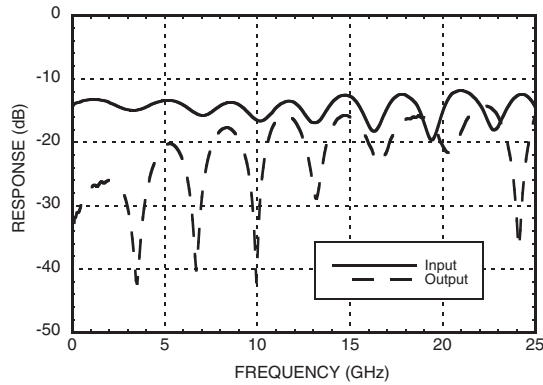

**Output Eye Diagram Continuous Snapshot for 24 GHz Input**

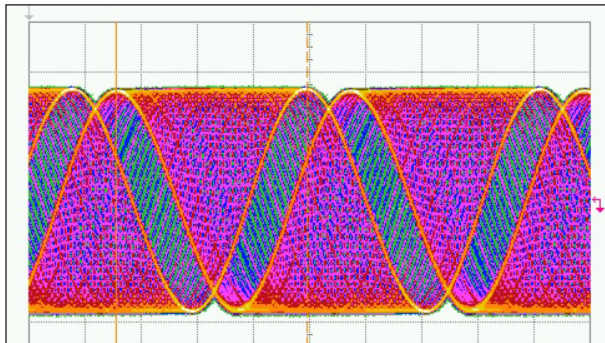

Time Scale: 10 ps/div  
Amplitude Scale: 80 mV/div

Test Conditions:  
VCC = 3.3V, VAC = 2.6V,  
VDC = varied from 1.6V to 1.9V  
(%25 of the whole delay range)  
Input Data: Single ended 300 mVp-p 24 GHz clock signal

Measurement Result:  
Time Delay = 34 ps

**Output Eye Diagram Continuous Snapshot for 10 Gbps Input**

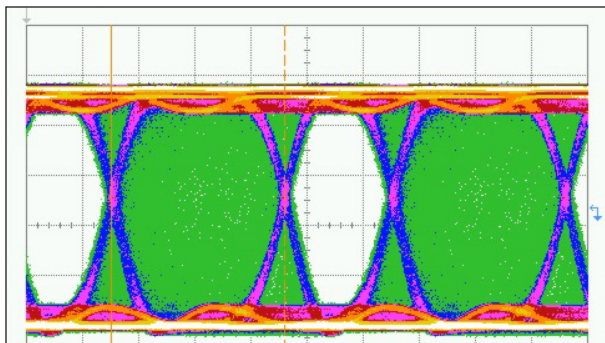

Time Scale: 20 ps/div  
Amplitude Scale: 100 mV/div

Test Conditions:  
VCC = 3.3V, VAC = 2.6V,  
VDC = varied from 1.1V to 2.3V  
(%100 of the whole delay range)  
Input Data: Differential 300 mVp-p 10 Gbps NRZ PRBS  
2<sup>23</sup>-1 pattern

Measurement Result:  
Time Delay = 61.5 ps

[1] VAC = 2.6V [2] VDC = 1.1V [3] Device measured on evaluation board with single-ended time domain gating

Information furnished by Analog Devices is believed to be accurate and reliable. However, no responsibility is assumed by Analog Devices for its use, nor for any infringements of patents or other rights of third parties that may result from its use. Specifications subject to change without notice. No license is granted by implication or otherwise under any patent or patent rights of Analog Devices. Trademarks and registered trademarks are the property of their respective owners.

For price, delivery, and to place orders: Analog Devices, Inc., One Technology Way, P.O. Box 9106, Norwood, MA 02062-9106 Phone: 781-329-4700 • Order online at [www.analog.com](http://www.analog.com) Application Support: Phone: 1-800-ANALOG-D



## BROADBAND ANALOG TIME DELAY, DC - 24 GHz

### Absolute Maximum Ratings

Power Supply Voltage (Vcc)	-0.5V to +3.7V
Input Voltage	Vcc -1.2V to Vcc +0.5V
Channel Temperature (Tc)	125 °C
Continuous P <sub>diss</sub> (T = 85 °C) (derate 54.96 mW/°C above 85 °C)	2.2 W
Thermal Resistance (junction to ground paddle)	18.20 °C/W
Storage Temperature	-65 to +150 °C
Operating Temperature	-40 to +70 °C



ELECTROSTATIC SENSITIVE DEVICE  
OBSERVE HANDLING PRECAUTIONS

### Outline Drawing

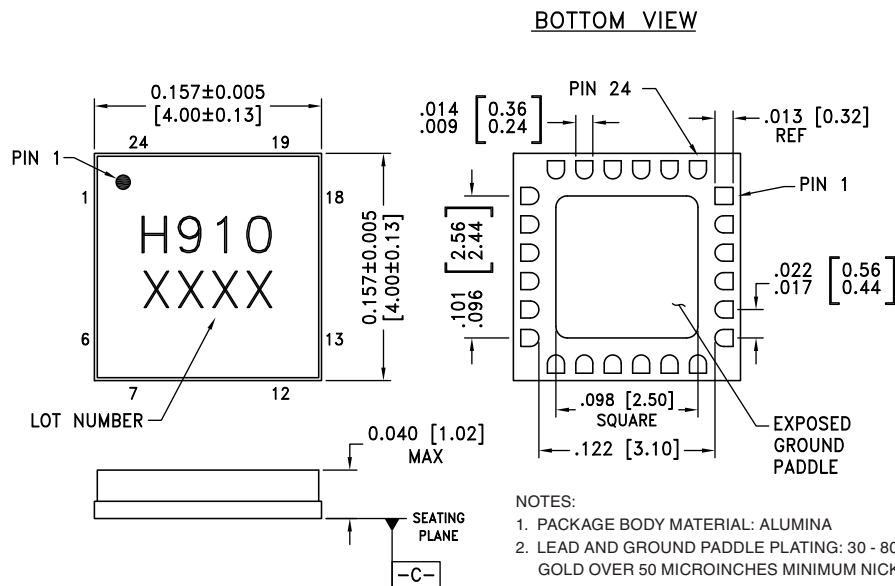

NOTES:

1. PACKAGE BODY MATERIAL: ALUMINA
2. LEAD AND GROUND PADDLE PLATING: 30 - 80 MICROINCHES GOLD OVER 50 MICROINCHES MINIMUM NICKLE
3. DIMENSIONS ARE IN INCHES [MILLIMETERS]
4. LEAD SPACING TOLERANCE IS NON-CUMULATIVE
5. PACKAGE WARP SHALL NOT EXCEED 0.05mm DATUM
6. ALL GROUND LEADS AND GROUND PADDLE MUST BE SOLDERED TO PCB RF GROUND

### Package Information

Part Number	Package Body Material	Lead Finish	MSL Rating	Package Marking <sup>[2]</sup>
HMC910LC4B	Alumina, White	Gold over Nickel	MSL3 <sup>[1]</sup>	H910 XXXX

[1] Max peak reflow temperature of 260 °C

[2] 4-Digit lot number XXXX



### Pin Descriptions

Pin Number	Function	Description	Interface Schematic
1, 6, 18	N/C	The pins are not connected internally; however, all data shown herein was measured with these pins connected to RF/DC ground externally.	
2, 5, 14, 17 Package Bottom	GND	Signal grounds should be connected to 0V. Ground paddle must be connected to DC ground	
3, 4	INP, INN	Differential Signal Inputs	
7, 10, 12, 13	Vee	Supply grounds should be connected to 0V.	
8	Vdc	Time delay control pin.	
9	ENB	Enable pin for the time delay. For normal operation; leave the pin open or apply +3.3V. To disable the part apply 0V. When disabled total current consumption drops to 15mA.	
11	Vac	Output amplitude control pin.	
15, 16	QN, QP	Differential Signal Outputs	

Information furnished by Analog Devices is believed to be accurate and reliable. However, no responsibility is assumed by Analog Devices for its use, nor for any infringements of patents or other rights of third parties that may result from its use. Specifications subject to change without notice. No license is granted by implication or otherwise under any patent or patent rights of Analog Devices. Trademarks and registered trademarks are the property of their respective owners.

For price, delivery, and to place orders: Analog Devices, Inc., One Technology Way, P.O. Box 9106, Norwood, MA 02062-9106  
Phone: 781-329-4700 • Order online at [www.analog.com](http://www.analog.com)  
Application Support: Phone: 1-800-ANALOG-D





**BROADBAND ANALOG TIME DELAY, DC - 24 GHz**

**Pin Descriptions (Continued)**

Pin Number	Function	Description	Interface Schematic
19 - 24	Vcc	Positive supply	

**Application Circuit**

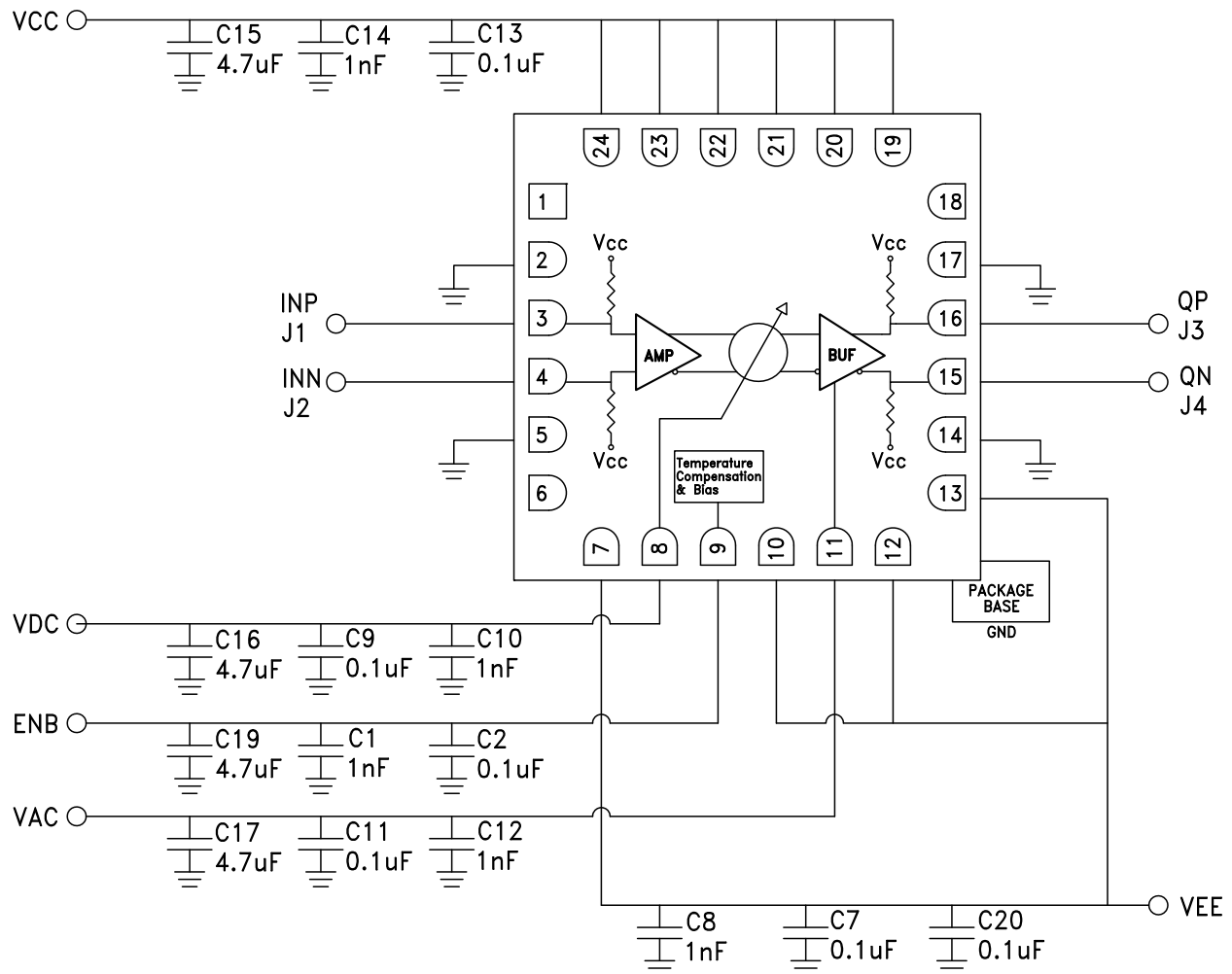

Information furnished by Analog Devices is believed to be accurate and reliable. However, no responsibility is assumed by Analog Devices for its use, nor for any infringements of patents or other rights of third parties that may result from its use. Specifications subject to change without notice. No license is granted by implication or otherwise under any patent or patent rights of Analog Devices. Trademarks and registered trademarks are the property of their respective owners.

For price, delivery, and to place orders: Analog Devices, Inc., One Technology Way, P.O. Box 9106, Norwood, MA 02062-9106 Phone: 781-329-4700 • Order online at [www.analog.com](http://www.analog.com) Application Support: Phone: 1-800-ANALOG-D



**BROADBAND ANALOG  
TIME DELAY, DC - 24 GHz**

**Evaluation PCB**

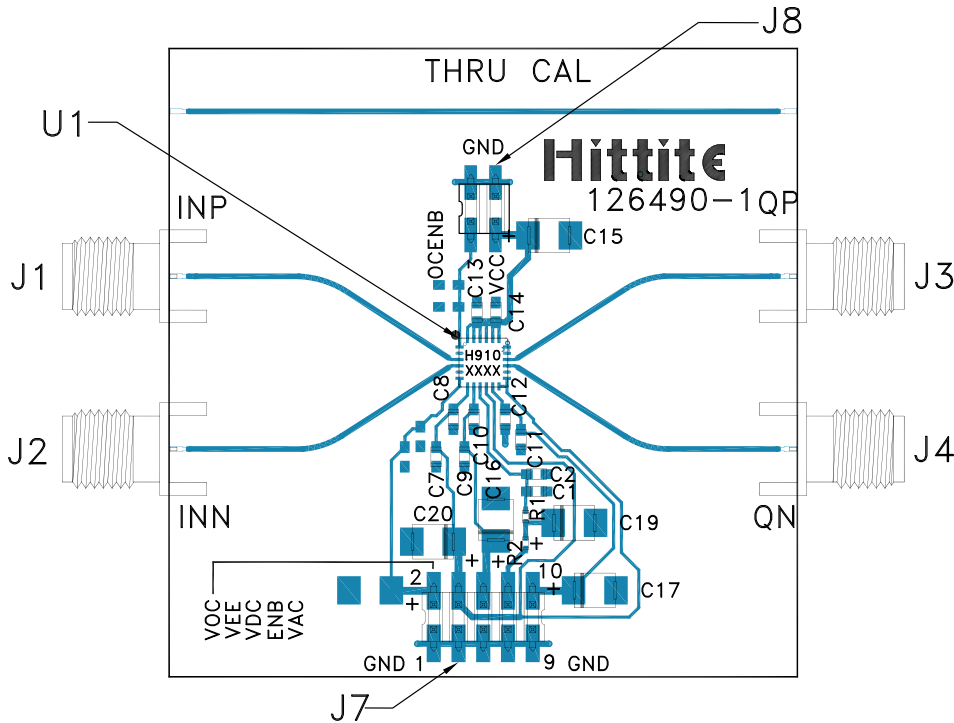

**List of Materials for Evaluation PCB 129874 [1]**

Item	Description
J1 - J4	K Connector
J7	10 Pin DC Connector
J8	4 Pin DC Connector
C1, C8, C10, C12, C14	1000 pF Capacitor, 0603 Pkg.
C2, C7, C9, C11, C13	0.1 μF Capacitor, 0603 Pkg.
C15, C16, C17, C19, C20	4.7 μF Capacitor, Tantalum
U1	HMC910LC4B Analog Phase Shifter
PCB [2]	126490 Evaluation Board

[1] Reference this number when ordering complete evaluation PCB

[2] Circuit Board Material: Rogers 4350 or Arlon 25 FR

The circuit board used in the application should use RF circuit design techniques. Signal lines should have 50 Ohm impedance while the package ground leads and exposed paddle should be connected directly to the ground plane similar to that shown. A sufficient number of via holes should be used to connect the top and bottom ground planes. The evaluation board should be mounted to an appropriate heat sink. The evaluation circuit board shown is available from Hittite upon request.

**BROADBAND ANALOG  
TIME DELAY, DC - 24 GHz****Notes:**