

## CEFB101-G Thru. CEFB105-G

Reverse Voltage: 50 to 600 Volts

Forward Current: 1.0 Amp

RoHS Device

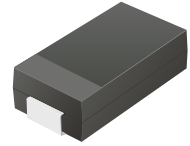

### Features

- Ideal for surface mount applications.
- Easy pick and place.
- Plastic package has Underwriters Lab. flammability classification 94V-0.
- Super fast recovery time for high efficient.
- Built-in strain relief.
- Low forward voltage drop.

### Mechanical data

- Case: JEDEC DO-214AA, molded plastic.
- Terminals: solderable per MIL-STD-750, method 2026.
- Polarity: Color band denotes cathode end.
- Approx. weight: 0.093 grams

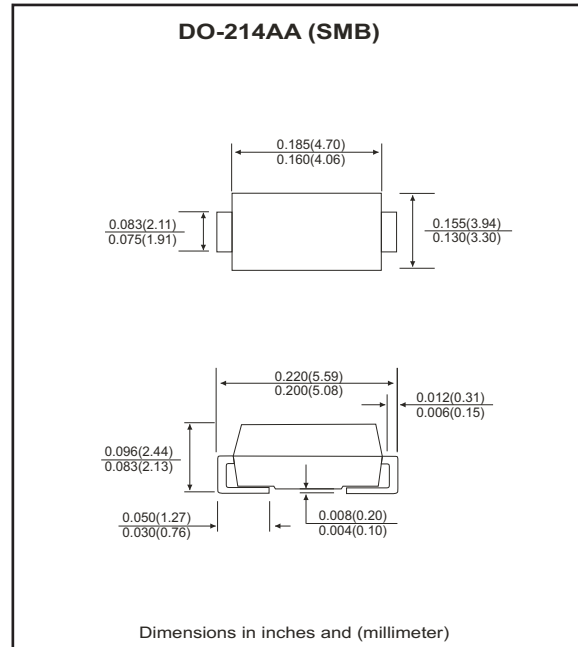

### Maximum Ratings and Electrical Characteristics

Parameter	Symbol	CEFB101-G	CEFB102-G	CEFB103-G	CEFB104-G	CEFB105-G	Units
Max. repetitive peak reverse voltage	$V_{RRM}$	50	100	200	400	600	V
Max. DC blocking voltage	$V_{DC}$	50	100	200	400	600	V
Max. RMS voltage	$V_{RMS}$	35	70	140	280	420	V
Peak surge forward current, 8.3ms single half sine-wave superimposed on rate load (JEDEC method)	$I_{FSM}$	30					A
Max. average forward current	$I_o$	1.0					A
Max. instantaneous forward voltage at 1.0A	$V_F$	0.875			1.1	1.25	V
Reverse recovery time	$T_{rr}$	25			35	50	nS
Max. DC reverse current at $T_A=25\text{ }^{\circ}\text{C}$ rated DC blocking voltage $T_A=125\text{ }^{\circ}\text{C}$	$I_R$	5.0 200					$\mu\text{A}$
Max. thermal resistance (Note 1)	$R_{\theta JL}$	13					$^{\circ}\text{C/W}$
Max. operating junction temperature	$T_J$	150					$^{\circ}\text{C}$
Storage temperature	$T_{STG}$	-55 to +150					$^{\circ}\text{C}$

Notes: 1. Thermal resistance from junction to lead mounted on P.C.B. with 8.0x8.0 mm copper pad area.

## RATING AND CHARACTERISTIC CURVES (CEFB101-G thru CEFB105-G)

Fig.1 Reverse Characteristics

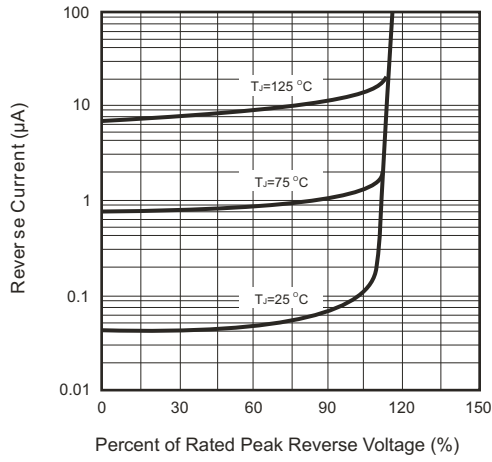

Fig.2 Forward Characteristics

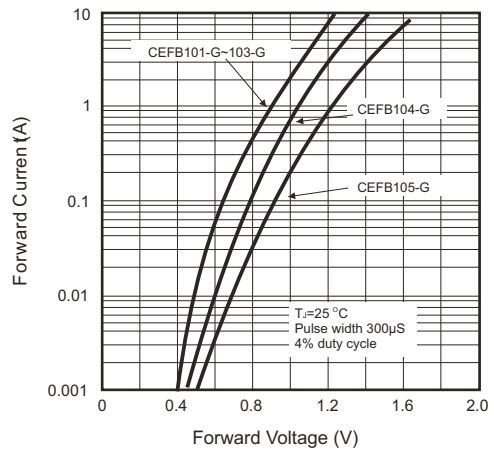

Fig.3 Junction Capacitance

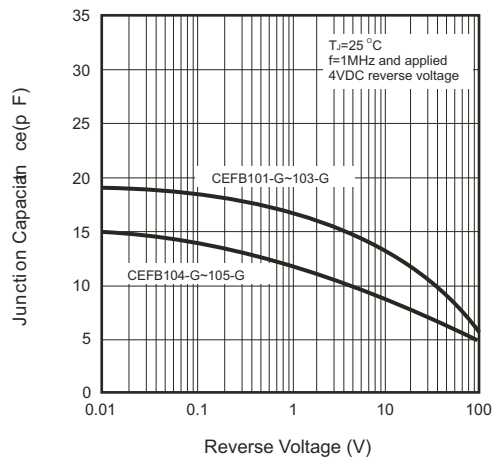

Fig.4 Non-repetitive Forward Surge Current

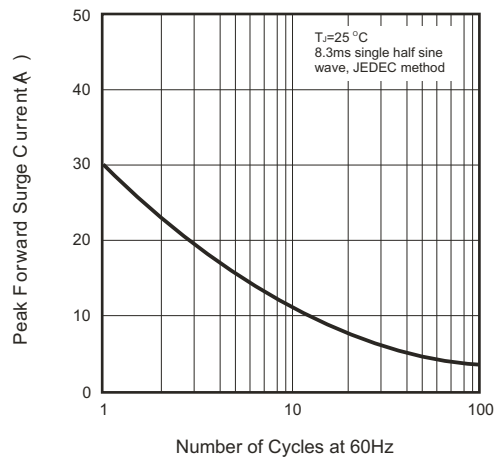

Fig.5 Test Circuit Diagram and Reverse Recovery Time Characteristics

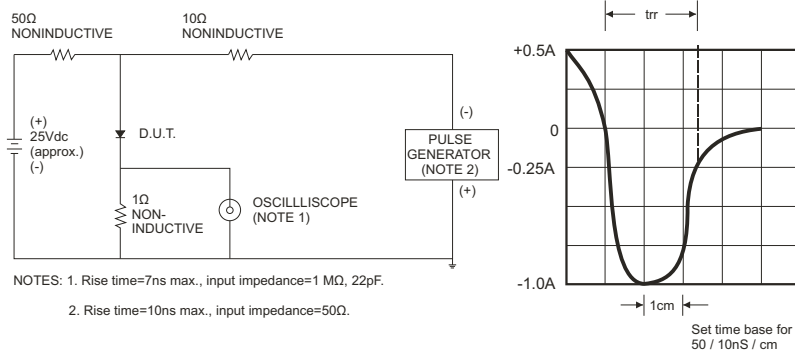

Fig.6 Current Derating Curve

