

SUMMARY

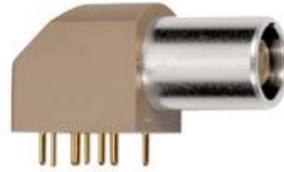

Image is for illustrative purpose only

Wires

Low	5
High	0
Coax	0
Triax	0
Quad	0
Fiber	0
Fluidic	0

Series	0B
Termination type	Female print PCB
IP rating	50
Cable Ø	0.00 - 0.00 mm
Matching parts	FGG.0B.305.CLAD52Z
Status	
Alternative part	

Download

- [Request a quote](#)
- [PCB Eagle Pattern](#)
- [PCB Altium Pattern](#)
- [Catalog](#)

TECHNICAL DETAILS

Mechanics

Shell Style/Model	EP.HLN*: Elbow receptacle for printed circuit (solder or screw fixing)
Keying	1 key (alpha=0, plug: male contacts, receptacle: female contacts)
Housing Material	PPS (Polyphenylene) shell, other pieces nickel plated brass
Cable Fixing	∅ 0 - 0 mm
Variant	

Performance

Configuration	0B.305/EPG : 5 Low Voltage
Insulator	L: PEEK (UL 94 / V-0/3.2, depends on material thickness)
Rated Current	6 Amps

Specifications

Contact Type: Print (straight)
Max. Matings: 5000
Contact Dia.: 0.7 mm (0.028in)
R (max): 6.1 mOhm
Vtest (contact-shell): 700 V (AC), 990 V (DC)
Vtest (contact-contact): 1000 V (AC), 1400 V (DC)

Others

Endurance (Shell): 5000
Temp (min / max): -55 °C / +250 °C
Humidity (max): <=95% [at 60 deg C /140 F]
Vibration: 15 g [10 Hz - 2000 Hz]
Shock Resistance: 100 g [6 ms]
Salt Spray Corrosion: >1000 hr
Climatical Category: 50/175/21
Shielding (min): 75 dB (10 MHz)
Shielding (min): 40 dB (1 GHz)
IP Rating: 50

DRAWINGS

Draws

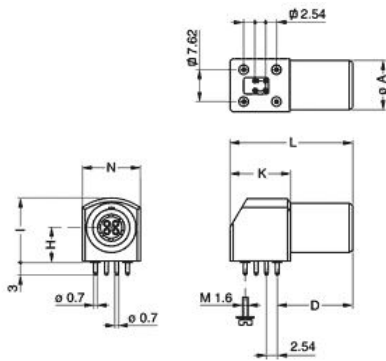

Dimensions

	A	D	H	I	K	L	N	R
mm.	9	14.6	6.7	12.6	13.3	25	11.7	7.62
in.	0,35	0,57	0,26	0,50	0,52	0,98	0,46	0,30

RECOMMENDED BY LEMO

Tools

None

Cables