



Is Now Part of



ON Semiconductor®

To learn more about ON Semiconductor, please visit our website at
www.onsemi.com

ON Semiconductor and the ON Semiconductor logo are trademarks of Semiconductor Components Industries, LLC dba ON Semiconductor or its subsidiaries in the United States and/or other countries. ON Semiconductor owns the rights to a number of patents, trademarks, copyrights, trade secrets, and other intellectual property. A listing of ON Semiconductor's product/patent coverage may be accessed at www.onsemi.com/site/pdf/Patent-Marking.pdf. ON Semiconductor reserves the right to make changes without further notice to any products herein. ON Semiconductor makes no warranty, representation or guarantee regarding the suitability of its products for any particular purpose, nor does ON Semiconductor assume any liability arising out of the application or use of any product or circuit, and specifically disclaims any and all liability, including without limitation special, consequential or incidental damages. Buyer is responsible for its products and applications using ON Semiconductor products, including compliance with all laws, regulations and safety requirements or standards, regardless of any support or applications information provided by ON Semiconductor. "Typical" parameters which may be provided in ON Semiconductor data sheets and/or specifications can and do vary in different applications and actual performance may vary over time. All operating parameters, including "Typicals" must be validated for each customer application by customer's technical experts. ON Semiconductor does not convey any license under its patent rights nor the rights of others. ON Semiconductor products are not designed, intended, or authorized for use as a critical component in life support systems or any FDA Class 3 medical devices or medical devices with a same or similar classification in a foreign jurisdiction or any devices intended for implantation in the human body. Should Buyer purchase or use ON Semiconductor products for any such unintended or unauthorized application, Buyer shall indemnify and hold ON Semiconductor and its officers, employees, subsidiaries, affiliates, and distributors harmless against all claims, costs, damages, and expenses, and reasonable attorney fees arising out of, directly or indirectly, any claim of personal injury or death associated with such unintended or unauthorized use, even if such claim alleges that ON Semiconductor was negligent regarding the design or manufacture of the part. ON Semiconductor is an Equal Opportunity/Affirmative Action Employer. This literature is subject to all applicable copyright laws and is not for resale in any manner.

FSAM30SM60A

Motion SPM® 2 Series

Features

- UL Certified No. E209204 (UL1557)
- 600 V - 30 A 3-Phase IGBT Inverter with Integral Gate Drivers and Protection
- Low-Loss, Short-Circuit Rated IGBTs
- Low Thermal Resistance Using Ceramic Substrate
- Separate Open-Emitter Pins from Low Side IGBTs for Three-Phase Current Sensing
- Single-Grounded Power Supply
- Optimized for 5 kHz Switching Frequency
- Built-in NTC Thermistor for Temperature Monitoring
- Inverter Power Rating of 2.4 kW / 100~253 VAC
- Adjustable Current Protection Level via Selection of Sense-IGBT Emitter's External Rs
- Isolation Rating: 2500 V_{rms} / min.

Applications

- Motion Control - Home Appliance / Industrial Motor

Resource

- [AN-9043 - Motion SPM® 2 Series User's Guide](#)

General Description

FSAM30SM60A is a Motion SPM® 2 module providing a fully-featured, high-performance inverter stage for AC Induction, BLDC, and PMSM motors. These modules integrate optimized gate drive of the built-in IGBTs to minimize EMI and losses, while also providing multiple on-module protection features including under-voltage lockouts, over-current shutdown, thermal monitoring, and fault reporting. The built-in, high-speed HVIC requires only a single supply voltage and translates the incoming logic-level gate inputs to the high-voltage, high-current drive signals required to properly drive the module's internal IGBTs. Separate negative IGBT terminals are available for each phase to support the widest variety of control algorithms.



Figure 1. Package Overview

Package Marking and Ordering Information

Device	Device Marking	Package	Packing Type	Quantity
FSAM30SM60A	FSAM30SM60A	S32AA-032	Rail	8

Integrated Power Functions

- 600V - 30 A IGBT inverter for three-phase DC / AC power conversion (please refer to Figure 3)

Integrated Drive, Protection and System Control Functions

- For inverter high-side IGBTs: gate drive circuit, high-voltage isolated high-speed level shifting control circuit Under-Voltage Lock-Out (UVLO) Protection
 Note) Available bootstrap circuit example is given in Figures 13 and 14.
- For inverter low-side IGBTs: gate drive circuit, Short-Circuit Protection (SCP) control supply circuit Under-Voltage Lock-Out (UVLO) Protection
- Temperature Monitoring: system temperature monitoring using built-in thermistor
 Note) Available temperature monitoring circuit is given in Figure 14.
- Fault signaling: corresponding to a SC fault (low-side IGBTs) and UV fault (low-side control supply)
- Input interface: active-LOW Interface, works with 3.3 / 5 V logic, Schmitt-trigger input

Pin Configuration



Figure 2. Top View

Pin Descriptions

Pin Number	Pin Name	Pin Description
1	$V_{CC(L)}$	Low-Side Common Bias Voltage for IC and IGBTs Driving
2	$COM_{(L)}$	Low-Side Common Supply Ground
3	$IN_{(UL)}$	Signal Input Terminal for Low-Side U-Phase
4	$IN_{(VL)}$	Signal Input Terminal for Low-Side V-Phase
5	$IN_{(WL)}$	Signal Input Terminal for Low-Side W-Phase
6	$COM_{(L)}$	Low-Side Common Supply Ground
7	V_{FO}	Fault Output
8	C_{FOD}	Capacitor for Fault Output Duration Selection
9	C_{SC}	Capacitor (Low-Pass Filter) for Short-Circuit Current Detection Input
10	R_{SC}	Resistor for Short-Circuit Current Detection
11	$IN_{(UH)}$	Signal Input for High-Side U-Phase
12	$V_{CC(UH)}$	High-Side Bias Voltage for U-Phase IC
13	$V_{B(U)}$	High-Side Bias Voltage for U-Phase IGBT Driving
14	$V_{S(U)}$	High-Side Bias Voltage Ground for U-Phase IGBT Driving
15	$IN_{(VH)}$	Signal Input for High-Side V-Phase
16	$COM_{(H)}$	High-Side Common Supply Ground
17	$V_{CC(VH)}$	High-Side Bias Voltage for V-Phase IC
18	$V_{B(V)}$	High-Side Bias Voltage for V-Phase IGBT Driving
19	$V_{S(V)}$	High-Side Bias Voltage Ground for V-Phase IGBT Driving
20	$IN_{(WH)}$	Signal Input for High-side W-Phase
21	$V_{CC(WH)}$	High-Side Bias Voltage for W-Phase IC
22	$V_{B(W)}$	High-Side Bias Voltage for W-Phase IGBT Driving
23	$V_{S(W)}$	High-Side Bias Voltage Ground for W-Phase IGBT Driving
24	V_{TH}	Thermistor Bias Voltage
25	R_{TH}	Series Resistor for the Use of Thermistor (Temperature Detection)
26	N_U	Negative DC-Link Input Terminal for U-Phase
27	N_V	Negative DC-Link Input Terminal for V-Phase
28	N_W	Negative DC-Link Input Terminal for W-Phase
29	U	Output for U-Phase
30	V	Output for V-Phase
31	W	Output for W-Phase
32	P	Positive DC-Link Input

Internal Equivalent Circuit and Input/Output Pins

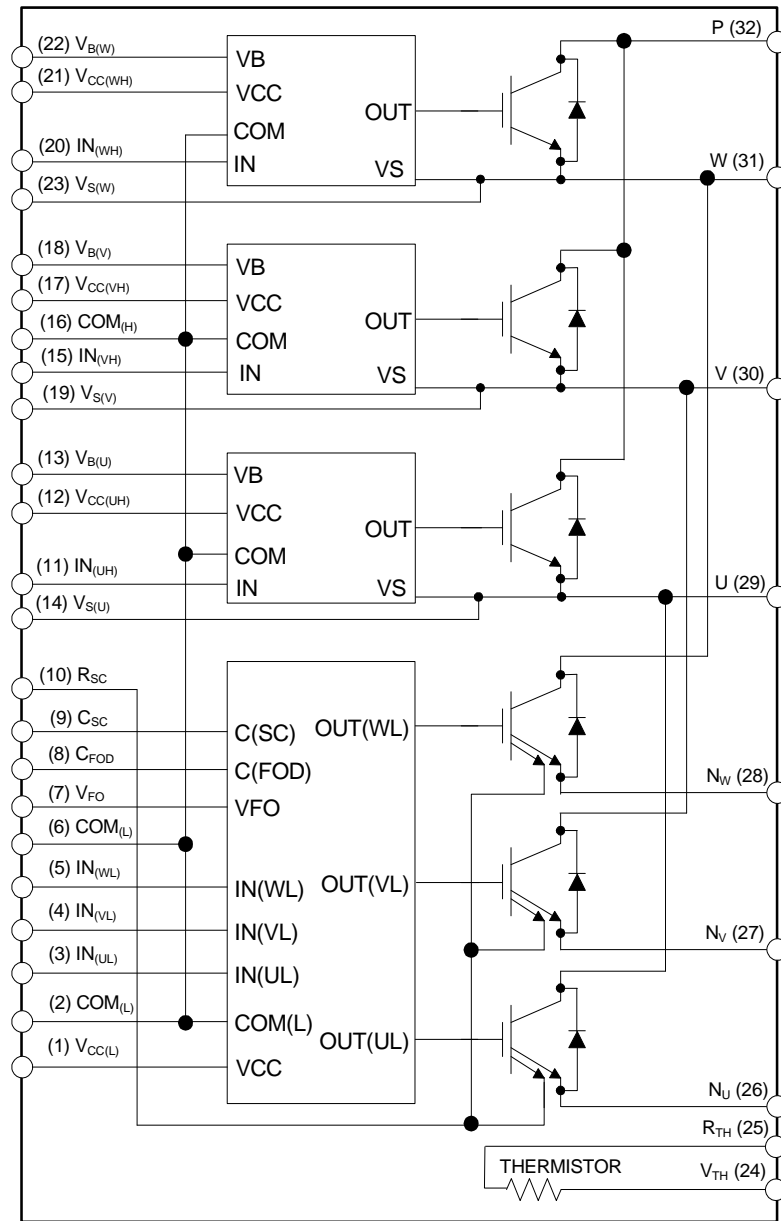

Figure 3. Internal Block Diagram

1st Notes:

1. Inverter low-side is composed of three sense-IGBTs including freewheeling diodes for each IGBT and one control IC which has gate driving, current-sensing and protection functions.
2. Inverter power side is composed of four inverter DC-link input pins and three inverter output pins.
3. Inverter high-side is composed of three normal-IGBTs including freewheeling diodes and three drive ICs for each IGBT.

Absolute Maximum Ratings (T_J = 25°C, unless otherwise specified.)

Inverter Part

Item	Symbol	Condition	Rating	Unit
Supply Voltage	V _{DC}	Applied to DC-Link	450	V
Supply Voltage (Surge)	V _{PN(Surge)}	Applied between P and N	500	V
Collector - Emitter Voltage	V _{CES}		600	V
Each IGBT Collector Current	± I _C	T _C = 25°C	30	A
Each IGBT Collector Current	± I _C	T _C = 100°C	16	A
Each IGBT Collector Current (Peak)	± I _{CP}	T _C = 25°C, Under 1ms Pulse Width	60	A
Collector Dissipation	P _C	T _C = 25°C per Chip	62	W
Operating Junction Temperature	T _J	(2nd Note 1)	-20 ~ 125	°C

2nd Notes:

1. It would be recommended that the average junction temperature should be limited to T_J ≤ 125°C (at T_C ≤ 100°C) in order to guarantee safe operation.

Control Part

Item	Symbol	Condition	Rating	Unit
Control Supply Voltage	V _{CC}	Applied between V _{CC(UH)} , V _{CC(VH)} , V _{CC(WH)} - COM _(H) , V _{CC(L)} - COM _(L)	20	V
High-Side Control Bias Voltage	V _{BS}	Applied between V _{B(U)} - V _{S(U)} , V _{B(V)} - V _{S(V)} , V _{B(W)} - V _{S(W)}	20	V
Input Signal Voltage	V _{IN}	Applied between IN _(UH) , IN _(VH) , IN _(WH) - COM _(H) , IN _(UL) , IN _(VL) , IN _(WL) - COM _(L)	-0.3 ~ V _{CC} +0.3	V
Fault Output Supply Voltage	V _{FO}	Applied between V _{FO} - COM _(L)	-0.3 ~ V _{CC} +0.3	V
Fault Output Current	I _{FO}	Sink Current at V _{FO} Pin	5	mA
Current-Sensing Input Voltage	V _{SC}	Applied between C _{SC} - COM _(L)	-0.3 ~ V _{CC} +0.3	V

Total System

Item	Symbol	Condition	Rating	Unit
Self-Protection Supply Voltage Limit (Short-Circuit Protection Capability)	V _{PN(PROT)}	Applied to DC-Link, V _{CC} = V _{BS} = 13.5 ~ 16.5 V, T _J = 125°C, Non-Repetitive, < 6 μs	400	V
Module Case Operation Temperature	T _C	See Figure 2	-20 ~ 100	°C
Storage Temperature	T _{STG}		-20 ~ 125	°C
Isolation Voltage	V _{ISO}	60Hz, Sinusoidal, AC 1 Minute, Connect Pins to Heat Sink Plate	2500	V _{rms}

Thermal Resistance

Item	Symbol	Condition	Min.	Typ.	Max.	Unit
Junction to Case Thermal Resistance	R _{th(j-c)Q}	Inverter IGBT Part (per 1/6 module)	-	-	2.00	°C/W
	R _{th(j-c)F}	Inverter FWDi Part (per 1/6 module)	-	-	3.20	°C/W
Contact Thermal Resistance	R _{th(c-f)}	Ceramic Substrate (per 1 Module) Thermal Grease Applied (2nd Note 3)	-	-	0.06	°C/W

2nd Notes:

2. For the measurement point of case temperature(T_C), please refer to Figure 2.
3. The thickness of thermal grease should not be more than 100 μm.

Electrical Characteristics

Inverter Part ($T_J = 25^\circ\text{C}$, unless otherwise specified.)

Item	Symbol	Condition	Min.	Typ.	Max.	Unit
Collector - Emitter Saturation Voltage	$V_{CE(SAT)}$	$V_{CC} = V_{BS} = 15\text{ V}$ $V_{IN} = 0\text{ V}$	-	-	2.30	V
		$I_C = 30\text{ A}, T_J = 125^\circ\text{C}$	-	-	2.40	V
FWDi Forward Voltage	V_{FM}	$V_{IN} = 5\text{ V}$	-	-	2.60	V
		$I_C = 30\text{ A}, T_J = 125^\circ\text{C}$	-	-	2.40	V
Switching Times	t_{ON}	$V_{PN} = 300\text{ V}, V_{CC} = V_{BS} = 15\text{ V}$ $I_C = 30\text{ A}, T_J = 25^\circ\text{C}$	-	0.39	-	μs
	$t_{C(ON)}$	$V_{IN} = 5\text{ V} \leftrightarrow 0\text{ V}$, Inductive Load (High, Low-side)	-	0.20	-	μs
	t_{OFF}	(High, Low-side)	-	0.95	-	μs
	$t_{C(OFF)}$	(High, Low-side)	-	0.39	-	μs
	t_{rr}	(2nd Note 4)	-	0.13	-	μs
Collector - Emitter Leakage Current	I_{CES}	$V_{CE} = V_{CES}, T_J = 25^\circ\text{C}$	-	-	250	μA

2nd Notes:

4. t_{ON} and t_{OFF} include the propagation delay time of the internal drive IC. $t_{C(ON)}$ and $t_{C(OFF)}$ are the switching time of IGBT itself under the given gate driving condition internally. For the detailed information, please see Figure 4.

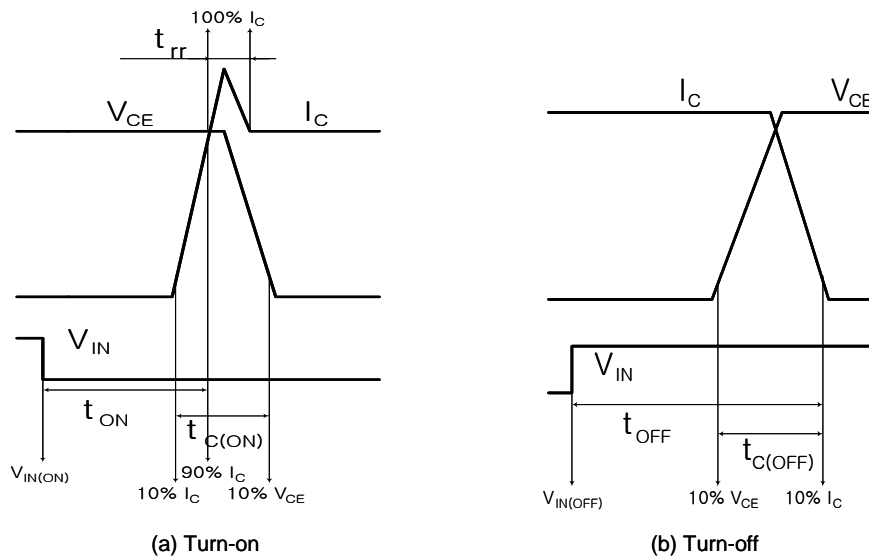

Figure 4. Switching Time Definition

Electrical Characteristics (T_J = 25°C, unless otherwise specified.)

Control Part

Item	Symbol	Condition	Min.	Typ.	Max.	Unit		
Quiescent V _{CC} Supply Current	I _{QCCL}	V _{CC} = 15 V I _{N(UL, VL, WL)} = 5V	V _{CC(L)} - COM _(L)	-	-	26	mA	
	I _{QCCH}	V _{CC} = 15 V I _{N(UH, VH, WH)} = 5V	V _{CC(UH)} , V _{CC(VH)} , V _{CC(WH)} - COM _(H)	-	-	130	μA	
Quiescent V _{BS} Supply Current	I _{QBS}	V _{BS} = 15 V I _{N(UH, VH, WH)} = 5V	V _{B(U)} - V _{S(U)} , V _{B(V)} - V _{S(V)} , V _{B(W)} - V _{S(W)}	-	-	420	μA	
Fault Output Voltage	V _{FOH}	V _{SC} = 0 V, V _{FO} Circuit: 4.7 kΩ to 5 V Pull-up	4.5	-	-	V		
	V _{FOL}	V _{SC} = 1 V, V _{FO} Circuit: 4.7 kΩ to 5 V Pull-up	-	-	1.1	V		
Short-Circuit Trip Level	V _{SC(ref)}	V _{CC} = 15 V (Note 5)	0.45	0.51	0.56	V		
Sensing Voltage of IGBT Current	V _{SEN}	R _{SC} = 56 Ω, R _{SU} = R _{SV} = R _{SW} = 0 Ω and I _C = 45 A (See a Figure 6)	0.45	0.51	0.56	V		
Supply Circuit Under-Voltage Protection	UV _{CCD}	Detection Level	11.5	12.0	12.5	V		
	UV _{CCR}	Reset Level	12.0	12.5	13.0	V		
	UV _{BSD}	Detection Level	7.3	9.0	10.8	V		
	UV _{BSR}	Reset Level	8.6	10.3	12.0	V		
Fault Output Pulse Width	t _{FOD}	C _{FOD} = 33 nF (2nd Note 6)	1.4	1.8	2.0	ms		
ON Threshold Voltage	V _{IN(ON)}	High-Side	Applied between I _{N(UH)} , I _{N(VH)} , I _{N(WH)} - COM _(H)		-	-	0.8	V
OFF Threshold Voltage	V _{IN(OFF)}		3.0	-	-	V		
ON Threshold Voltage	V _{IN(ON)}	Low-Side	Applied between I _{N(UL)} , I _{N(VL)} , I _{N(WL)} - COM _(L)		-	-	0.8	V
OFF Threshold Voltage	V _{IN(OFF)}		3.0	-	-	V		
Resistance of Thermistor	R _{TH}	@ T _{TH} = 25°C (2nd Note 7, Figure 5)	-	50	-	kΩ		
		@ T _{TH} = 100°C (2nd Note 7, Figure 5)	-	3.4	-	kΩ		

2nd Notes:

- Short-circuit protection is functioning only at the low-sides. It would be recommended that the value of the external sensing resistor (R_{SC}) should be selected around 56 Ω in order to make the SC trip-level of about 45A at the shunt resistors (R_{SU}, R_{SV}, R_{SW}) of 0 Ω. For the detailed information about the relationship between the external sensing resistor (R_{SC}) and the shunt resistors (R_{SU}, R_{SV}, R_{SW}), please see Figure 6.
- The fault-out pulse width t_{FOD} depends on the capacitance value of C_{FOD} according to the following approximate equation: C_{FOD} = 18.3 × 10⁻⁶ × t_{FOD} [F]
- T_{TH} is the temperature of thermistor itself. To know case temperature (T_C), please make the experiment considering your application.



Figure 5. R-T Curve of The Built-in Thermistor

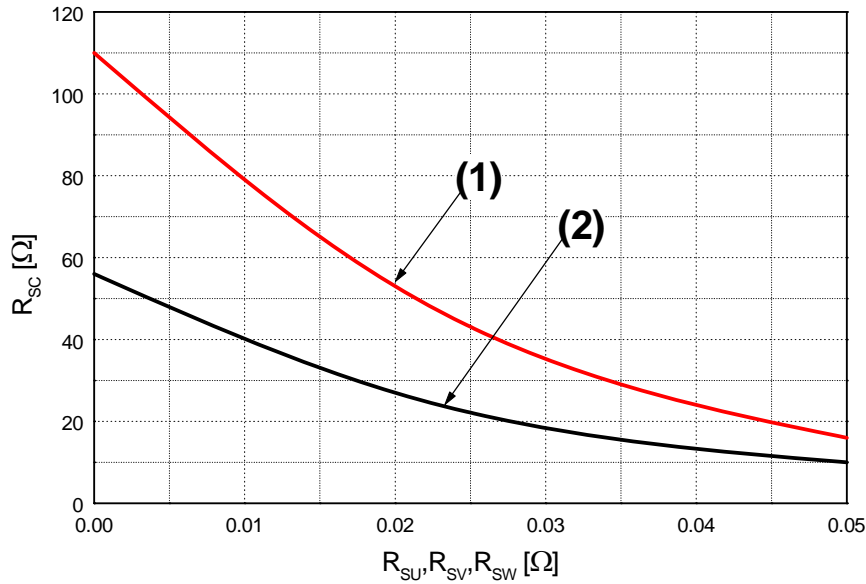

Figure 6. R_{SC} Variation by Change of Shunt Resistors (R_{SU}, R_{SV}, R_{SW}) for Short-Circuit Protection
 (1) @ Current Trip Level \approx 30 A
 (2) @ Current Trip Level \approx 45 A

Recommended Operating Conditions

Item	Symbol	Condition	Min.	Typ.	Max.	Unit
Supply Voltage	V_{PN}	Applied between P - N_U, N_V, N_W	-	300	400	V
Control Supply Voltage	V_{CC}	Applied between $V_{CC(UH)}, V_{CC(VH)}, V_{CC(WH)}$ - $COM_{(H)}, V_{CC(L)} - COM_{(L)}$	13.5	15.0	16.5	V
High-side Bias Voltage	V_{BS}	Applied between $V_{B(U)} - V_{S(U)}, V_{B(V)} - V_{S(V)}, V_{B(W)} - V_{S(W)}$	13.0	15.0	18.5	V
Blanking Time for Preventing Arm-short	t_{dead}	For Each Input Signal	3.0	-	-	μs
PWM Input Signal	f_{PWM}	$T_C \leq 100^\circ C, T_J \leq 125^\circ C$	-	5	-	kHz
Minimum Input Pulse Width	$PW_{IN(OFF)}$	$200 \leq V_{PN} \leq 400 V, 13.5 \leq V_{CC} \leq 16.5 V, 13.0 \leq V_{BS} \leq 18.5 V, 0 \leq I_C \leq 60 A, -20 \leq T_J \leq 125^\circ C, V_{IN} = 5 V \leftrightarrow 0 V, \text{Inductive Load (2nd Note 8)}$	3	-	-	μs
Input ON Threshold Voltage	$V_{IN(ON)}$	Applied between $IN_{(UH)}, IN_{(VH)}, IN_{(WH)}$ - $COM_{(H)}, IN_{(UL)}, IN_{(VL)}, IN_{(WL)}$ - $COM_{(L)}$	0 ~ 0.65			V
Input OFF Threshold Voltage	$V_{IN(OFF)}$	Applied between $IN_{(UH)}, IN_{(VH)}, IN_{(WH)}$ - $COM_{(H)}, IN_{(UL)}, IN_{(VL)}, IN_{(WL)}$ - $COM_{(L)}$	4 ~ 5.5			V

2nd Notes:

8. Motion SPM® 2 product might not make response if the $PW_{IN(OFF)}$ is less than the recommended minimum value.

Mechanical Characteristics and Ratings

Item	Condition		Min.	Typ.	Max.	Units
Mounting Torque	Mounting Screw: M4 (2nd Note 9 and 10)	Recommended 10 kg•cm	8	10	12	kg•cm
		Recommended 0.98 N•m	0.78	0.98	1.17	N•m
Ceramic Flatness		See Figure 7	0	-	+120	μm
Weight			-	35	-	g

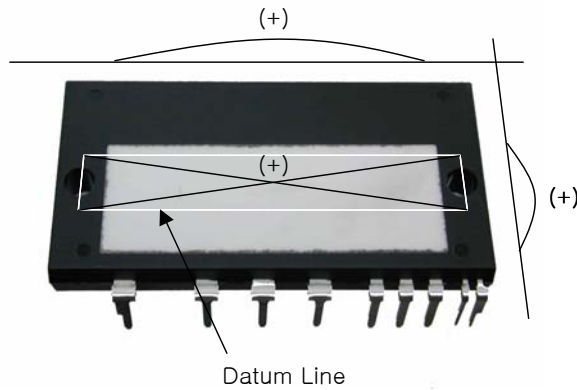

Figure 7. Flatness Measurement Position of The Ceramic Substrate

2nd Notes:

- 9. Do not make over torque or mounting screws. Much mounting torque may cause ceramic substrate cracks and bolts and Al heat-sink destruction.
- 10. Avoid one side tightening stress. Figure 8 shows the recommended torque order for mounting screws. Uneven mounting can cause the Motion SPM® 2 package ceramic substrate to be damaged.



Figure 8. Mounting Screws Torque Order (1 → 2)

Time Charts of Protective Function



- P1 : Normal operation: IGBT ON and conducting current .
- P2 : Under-voltage detection.
- P3 : IGBT gate interrupt.
- P4 : Fault signal generation.
- P5 : Under-voltage reset.
- P6 : Normal operation: IGBT ON and conducting current.

Figure 9. Under-Voltage Protection (Low-Side)



- P1 : Normal operation: IGBT ON and conducting current.
- P2 : Under-voltage detection.
- P3 : IGBT gate interrupt.
- P4 : No fault signal.
- P5 : Under-voltage reset.
- P6 : Normal operation: IGBT ON and conducting current.

Figure 10. Under-Voltage Protection (High-Side)



- P1 : Normal operation: IGBT ON and conducting current.
- P2 : Short-circuit current detection.
- P3 : IGBT gate interrupt / fault signal generation.
- P4 : IGBT is slowly turned off.
- P5 : IGBT OFF signal.
- P6 : IGBT ON signal: but IGBT cannot be turned on during the fault-output activation.
- P7 : IGBT OFF state.
- P8 : Fault-output reset and normal operation start.

Figure 11. Short-Circuit Protection (Low-Side Operation Only)



Figure 12. Recommended MCU I/O Interface Circuit

3rd Notes:

1. It would be recommended that by-pass capacitors for the gating input signals, $IN_{(UL)}$, $IN_{(VL)}$, $IN_{(WL)}$, $IN_{(UH)}$, $IN_{(VH)}$ and $IN_{(WH)}$ should be placed on the Motion SPM® 2 product pins and on the both sides of MCU and Motion SPM 2 Product for the fault output signal, V_{FO} , as close as possible.
2. The logic input works with standard CMOS or LSTTL outputs.
3. $R_{PL}C_{PL}/R_{PH}C_{PH}/R_{PF}C_{PF}$ coupling at each Motion SPM 2 product input is recommended in order to prevent input/output signals' oscillation and it should be as close as possible to each of Motion SPM 2 Product pins.



Figure 13. Recommended Bootstrap Operation Circuit and Parameters

3rd Notes:

4. It would be recommended that the bootstrap diode, D_{BS} , has soft and fast recovery characteristics.
5. The ceramic capacitor placed between V_{CC} - COM should be over $0.1 \mu F$ and mounted as close to the pins of the Motion SPM® 2 product as possible.

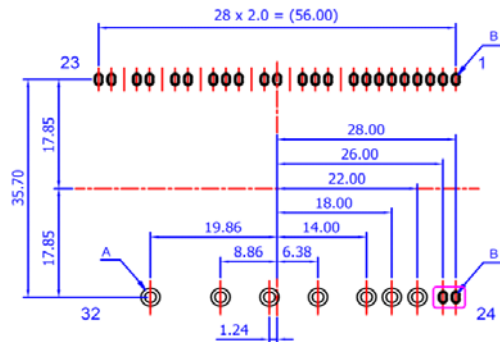
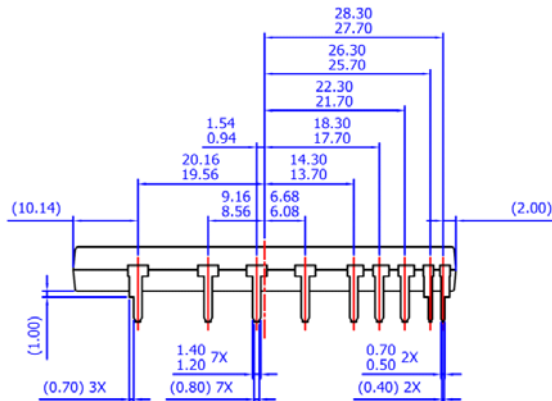
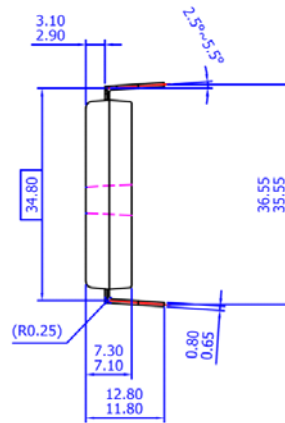
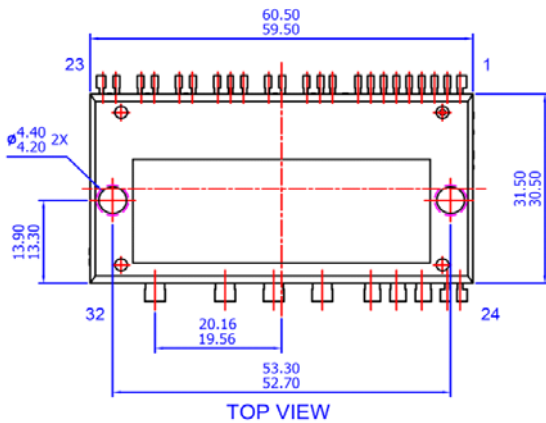
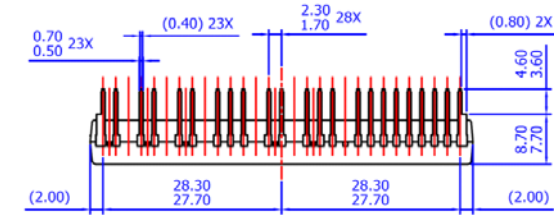

Figure 14. Application Circuit

4th Notes:

1. $R_{PI}C_{PI}/R_{PH}C_{PH}/R_{PF}C_{PF}$ coupling at each Motion SPM® 2 product input is recommended in order to prevent input signals' oscillation and it should be as close as possible to each Motion SPM 2 product input pin.
2. By virtue of integrating an application specific type HVIC inside the Motion SPM 2 product, direct coupling to MCU terminals without any optocoupler or transformer isolation is possible.
3. V_{FO} output is open-collector type. This signal line should be pulled up to the positive side of the 5 V power supply with approximately 4.7 kΩ resistance. Please refer to Figure 12.
4. C_{SP15} of around seven times larger than bootstrap capacitor C_{BS} is recommended.
5. V_{FO} output pulse width should be determined by connecting an external capacitor (C_{FOD}) between C_{FOD} (pin 8) and $COM_{(L)}$ (pin 2). (Example : if $C_{FOD} = 33$ nF, then $t_{FO} = 1.8$ ms (typ.)) Please refer to the 2nd note 6 for calculation method.
6. Each input signal line should be pulled up to the 5 V power supply with approximately 4.7 kΩ (at high side input) or 2 kΩ (at low side input) resistance (other RC coupling circuits at each input may be needed depending on the PWM control scheme used and on the wiring impedance of the system's printed circuit board). Approximately a 0.22 ~ 2 nF by-pass capacitor should be used across each power supply connection terminals.
7. To prevent errors of the protection function, the wiring around R_{SC} , R_F and C_{SC} should be as short as possible.
8. In the short-circuit protection circuit, please select the $R_F C_{SC}$ time constant in the range 3 ~ 4 μs.
9. Each capacitor should be mounted as close to the pins of the Motion SPM 2 product as possible.
10. To prevent surge destruction, the wiring between the smoothing capacitor and the P & N pins should be as short as possible. The use of a high frequency non-inductive capacitor of around 0.1 ~ 0.22 μF between the P&N pins is recommended.
11. Relays are used at almost every systems of electrical equipments of home appliances. In these cases, there should be sufficient distance between the MCU and the relays. It is recommended that the distance be 5 cm at least.

Detailed Package Outline Drawings



- NOTES: UNLESS OTHERWISE SPECIFIED
 A) THIS PACKAGE DOES NOT COMPLY TO ANY CURRENT PACKAGING STANDARD
 B) ALL DIMENSIONS ARE IN MILLIMETERS.
 C) DIMENSIONS ARE EXCLUSIVE OF BURRS, MOLD FLASH, AND TIE BAR EXTRUSIONS.
 D) () IS REFERENCE
 E) [] IS ASS'Y QUALITY
 F) DRAWING FILENAME: MOD32AAREV2.0

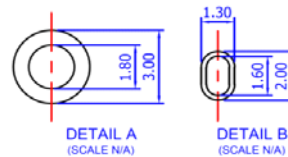

LAND PATTERN RECOMMENDATIONS

Package drawings are provided as a service to customers considering Fairchild components. Drawings may change in any manner without notice. Please note the revision and/or data on the drawing and contact a Fairchild Semiconductor representative to verify or obtain the most recent revision. Package specifications do not expand the terms of Fairchild's worldwide therm and conditions, specifically the the warranty therein, which covers Fairchild products.





Always visit Fairchild Semiconductor's online packaging area for the most recent package drawings:

<http://www.fairchildsemi.com/dwg/MO/MOD32AA.pdf>



TRADEMARKS

The following includes registered and unregistered trademarks and service marks, owned by Fairchild Semiconductor and/or its global subsidiaries, and is not intended to be an exhaustive list of all such trademarks.

- | | | | |
|---|--|---|---|
| AccuPower™ | F-PFS™ |  | Sync-Lock™ |
| AX-CAP®* | FRFET® | PowerTrench® |  SYSTEM GENERAL® |
| BitSiC™ | Global Power Resource™ | PowerXS™ | TinyBoost® |
| Build it Now™ | GreenBridge™ | Programmable Active Droop™ | TinyBuck® |
| CorePLUS™ | Green FPS™ | QFET® | TinyCalc™ |
| CorePOWER™ | Green FPS™ e-Series™ | QS™ | TinyLogic® |
| CROSSVOLT™ | Gmax™ | Quiet Series™ | TINYOPTO™ |
| CTL™ | GTO™ | RapidConfigure™ | TinyPower™ |
| Current Transfer Logic™ | IntelliMAX™ |  Saving our world, 1mW/W/kW at a time™ | TinyPWM™ |
| DEUXPEED® | ISOPLANAR™ | SignalWise™ | TinyWire™ |
| Dual Cool™ | Making Small Speakers Sound Louder and Better™ | SmartMax™ | TranSiC™ |
| EcoSPARK® | MegaBuck™ | SMART START™ | TriFault Detect™ |
| EfficientMax™ | MICROCOUPLER™ | Solutions for Your Success™ | TRUECURRENT®* |
| ESBC™ | MicroFET™ | SPM® | µSerDes™ |
|  | MicroPak™ | STEALTH™ |  SerDes® |
| Fairchild® | MicroPak2™ | SuperFET® | UHC™ |
| Fairchild Semiconductor® | MillerDrive™ | SuperSOT™-3 | Ultra FRFET™ |
| FACT Quiet Series™ | MotionMax™ | SuperSOT™-6 | UniFET™ |
| FACT® | mWSaver® | SuperSOT™-8 | VCX™ |
| FAST® | OptoHiT™ | SupreMOS® | VisualMax™ |
| FastvCore™ | OPTOLOGIC® | SyncFET™ | VoltagePlus™ |
| FETBench™ | OPTOPLANAR® | | XS™ |
| FPS™ | | | |

* Trademarks of System General Corporation, used under license by Fairchild Semiconductor.

DISCLAIMER

FAIRCHILD SEMICONDUCTOR RESERVES THE RIGHT TO MAKE CHANGES WITHOUT FURTHER NOTICE TO ANY PRODUCTS HEREIN TO IMPROVE RELIABILITY, FUNCTION, OR DESIGN. FAIRCHILD DOES NOT ASSUME ANY LIABILITY ARISING OUT OF THE APPLICATION OR USE OF ANY PRODUCT OR CIRCUIT DESCRIBED HEREIN; NEITHER DOES IT CONVEY ANY LICENSE UNDER ITS PATENT RIGHTS, NOR THE RIGHTS OF OTHERS. THESE SPECIFICATIONS DO NOT EXPAND THE TERMS OF FAIRCHILD'S WORLDWIDE TERMS AND CONDITIONS, SPECIFICALLY THE WARRANTY THEREIN, WHICH COVERS THESE PRODUCTS.

LIFE SUPPORT POLICY

FAIRCHILD'S PRODUCTS ARE NOT AUTHORIZED FOR USE AS CRITICAL COMPONENTS IN LIFE SUPPORT DEVICES OR SYSTEMS WITHOUT THE EXPRESS WRITTEN APPROVAL OF FAIRCHILD SEMICONDUCTOR CORPORATION.

As used herein:

1. Life support devices or systems are devices or systems which, (a) are intended for surgical implant into the body or (b) support or sustain life, and (c) whose failure to perform when properly used in accordance with instructions for use provided in the labeling, can be reasonably expected to result in a significant injury of the user.
2. A critical component in any component of a life support, device, or system whose failure to perform can be reasonably expected to cause the failure of the life support device or system, or to affect its safety or effectiveness.

ANTI-COUNTERFEITING POLICY

Fairchild Semiconductor Corporation's Anti-Counterfeiting Policy. Fairchild's Anti-Counterfeiting Policy is also stated on our external website, www.fairchildsemi.com, under Sales Support.

Counterfeiting of semiconductor parts is a growing problem in the industry. All manufacturers of semiconductor products are experiencing counterfeiting of their parts. Customers who inadvertently purchase counterfeit parts experience many problems such as loss of brand reputation, substandard performance, failed applications, and increased cost of production and manufacturing delays. Fairchild is taking strong measures to protect ourselves and our customers from the proliferation of counterfeit parts. Fairchild strongly encourages customers to purchase Fairchild parts either directly from Fairchild or from Authorized Fairchild Distributors who are listed by country on our web page cited above. Products customers buy either from Fairchild directly or from Authorized Fairchild Distributors are genuine parts, have full traceability, meet Fairchild's quality standards for handling and storage and provide access to Fairchild's full range of up-to-date technical and product information. Fairchild and our Authorized Distributors will stand behind all warranties and will appropriately address any warranty issues that may arise. Fairchild will not provide any warranty coverage or other assistance for parts bought from Unauthorized Sources. Fairchild is committed to combat this global problem and encourage our customers to do their part in stopping this practice by buying direct or from authorized distributors.

PRODUCT STATUS DEFINITIONS

Definition of Terms

Datasheet Identification	Product Status	Definition
Advance Information	Formative / In Design	Datasheet contains the design specifications for product development. Specifications may change in any manner without notice.
Preliminary	First Production	Datasheet contains preliminary data; supplementary data will be published at a later date. Fairchild Semiconductor reserves the right to make changes at any time without notice to improve design.
No Identification Needed	Full Production	Datasheet contains final specifications. Fairchild Semiconductor reserves the right to make changes at any time without notice to improve the design.
Obsolete	Not In Production	Datasheet contains specifications on a product that is discontinued by Fairchild Semiconductor. The datasheet is for reference information only.

Rev. I66

ON Semiconductor and  are trademarks of Semiconductor Components Industries, LLC dba ON Semiconductor or its subsidiaries in the United States and/or other countries. ON Semiconductor owns the rights to a number of patents, trademarks, copyrights, trade secrets, and other intellectual property. A listing of ON Semiconductor's product/patent coverage may be accessed at www.onsemi.com/site/pdf/Patent-Marking.pdf. ON Semiconductor reserves the right to make changes without further notice to any products herein. ON Semiconductor makes no warranty, representation or guarantee regarding the suitability of its products for any particular purpose, nor does ON Semiconductor assume any liability arising out of the application or use of any product or circuit, and specifically disclaims any and all liability, including without limitation special, consequential or incidental damages. Buyer is responsible for its products and applications using ON Semiconductor products, including compliance with all laws, regulations and safety requirements or standards, regardless of any support or applications information provided by ON Semiconductor. "Typical" parameters which may be provided in ON Semiconductor data sheets and/or specifications can and do vary in different applications and actual performance may vary over time. All operating parameters, including "Typicals" must be validated for each customer application by customer's technical experts. ON Semiconductor does not convey any license under its patent rights nor the rights of others. ON Semiconductor products are not designed, intended, or authorized for use as a critical component in life support systems or any FDA Class 3 medical devices or medical devices with a same or similar classification in a foreign jurisdiction or any devices intended for implantation in the human body. Should Buyer purchase or use ON Semiconductor products for any such unintended or unauthorized application, Buyer shall indemnify and hold ON Semiconductor and its officers, employees, subsidiaries, affiliates, and distributors harmless against all claims, costs, damages, and expenses, and reasonable attorney fees arising out of, directly or indirectly, any claim of personal injury or death associated with such unintended or unauthorized use, even if such claim alleges that ON Semiconductor was negligent regarding the design or manufacture of the part. ON Semiconductor is an Equal Opportunity/Affirmative Action Employer. This literature is subject to all applicable copyright laws and is not for resale in any manner.

PUBLICATION ORDERING INFORMATION

LITERATURE FULFILLMENT:

Literature Distribution Center for ON Semiconductor
19521 E. 32nd Pkwy, Aurora, Colorado 80011 USA
Phone: 303-675-2175 or 800-344-3860 Toll Free USA/Canada
Fax: 303-675-2176 or 800-344-3867 Toll Free USA/Canada
Email: orderlit@onsemi.com

N. American Technical Support: 800-282-9855 Toll Free
USA/Canada
Europe, Middle East and Africa Technical Support:
Phone: 421 33 790 2910
Japan Customer Focus Center
Phone: 81-3-5817-1050

ON Semiconductor Website: www.onsemi.com
Order Literature: <http://www.onsemi.com/orderlit>
For additional information, please contact your local
Sales Representative