

TSYS02D

Digital Temperature Sensor

SPECIFICATIONS

- **High Accuracy Temperature Sensor**
- **16 bit Resolution**
- **High Speed, low Response Time**
- **Low Power Consumption**
- **I²C Interface**
- **Small TDFN8 Package**

The TSYS02D is a single chip, temperature sensor. It provides factory calibrated data corresponding to the measured temperature.

The data is provided via **I²C interface**.

The temperature range is -40°C ... +125°C while the resolution is 0.01°C.

The TSYS02D can be interfaced to any microcontroller by an I²C interface.

The TDFN8 package provides smallest size and very fast time response.

FEATURES

- High Accuracy $\pm 0.2^{\circ}\text{C}$ @ Temp.: $-5^{\circ}\text{C} \dots +50^{\circ}\text{C}$
- Adjustment of high accuracy temperature range on request
- Low Supply Current $< 420\mu\text{A}$ (standby $< 0.14\mu\text{A}$)
- I²C Interface up to 400kHz
- Small IC-Package TDFN8 2.5mm x 2.5mm
- Operating Temperature Range: $-40^{\circ}\text{C} \dots +125^{\circ}\text{C}$

APPLICATIONS

- Industrial Control
- Replacement of Precision RTDs, Thermistors and NTCs
- Heating / Cooling Systems
- HVAC

ABSOLUTE MAXIMUM RATINGS

Absolute maximum ratings are limiting values of permitted operation and should never be exceeded under the worst possible conditions either initially or consequently. If exceeded by even the smallest amount, instantaneous catastrophic failure can occur. And even if the device continues to operate satisfactorily, its life may be considerably shortened.

Parameter	Symbol	Conditions	Min	Typ	Max	Unit
Supply Voltage	VDD		-0.3		+3.6	V
Operating Temperature	Top		-40		+125	°C
Storage temperature	Tstor		-55		+150	°C
ESD rating	ESD	Human Body Model (HBM) pin to pin incl. VDD & GND	-2		+2	kV
Humidity	Hum		Non condensing			

OPERATING CONDITIONS

Parameter	Symbol	Conditions	Min	Typ	Max	Unit
Operating Supply Voltage	V _{DD}	stabilized	1.5		3.6	V
Supply Current	I _{DD}	1 sample per second		18		μA
Standby current	IS	No conversion, VDD = 3V T = 25°C T = 85°C		0.02	0.14	μA
				0.70	1.40	μA
Peak Supply Current	I _{DD}	During conversion		420		μA
Conversion time	T _{CONV}			43		ms
Serial Data Clock I ² C	F _{SCL}				400	kHz
VDD Capacitor		Place close to the chip	100nF			

OPERATIONAL CHARACTERISTICS

If not otherwise noted, 3.3V supply voltage is applied.

Parameter	Symbol	Conditions	Min	Typ	Max	Unit
Temp. Measurement Range	T _{RANG}		-40		125	°C
Accuracy 1	T _{ACC1}	-5°C < T < +50°C V _{DD} = 3.2V – 3.4V	-0.2		+0.2	°C
Accuracy 2	T _{ACC2}	-20°C < T < +100°C V _{DD} = 3.2V – 3.4V	-0.5		+0.5	°C
Accuracy 3	T _{ACC2}	-40°C < T < +125°C V _{DD} = 3.2V – 3.4V	-1.0		+1.0	°C
PSRR Power Supply Reject Ratio		V _{DD} = 2.7 – 3.6 T = 25°C, C = 100nF			0.1	°C
Temperature Resolution	T _{RES}				0.01	°C
Self Heating	SH ₁	10 samples/s, 60s, still air			0.1	°C

ACCURACY

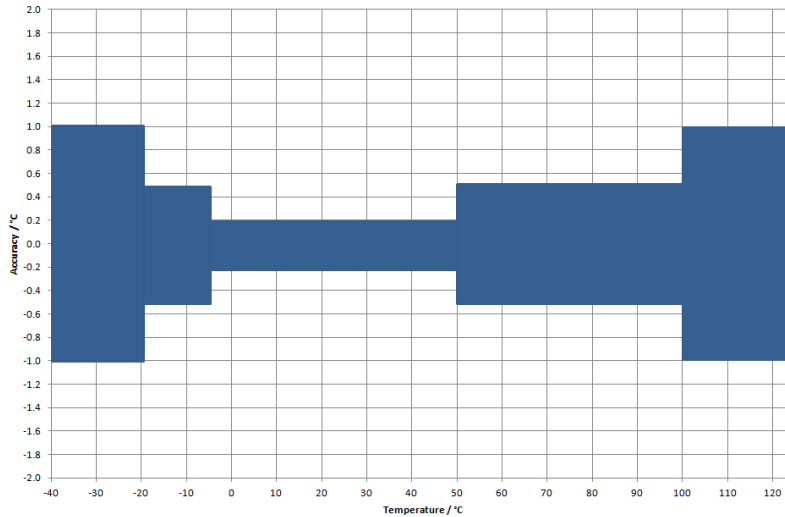

ANALOGUE TO DIGITAL CONVERTER

Parameter	Symbol	Conditions	Min	Typ	Max	Unit
Resolution				16		bit
Conversion Time	t _c			43		ms

DIGITAL INPUTS (SCLK, SDA)

Parameter	Symbol	Conditions	Min	Typ	Max	Unit
Input High Voltage	V _{IH}	V _{DD} = 1.5...3.6V	0.7 V _{DD}		V _{DD}	V
Input Low Voltage	V _{IL}	V _{DD} = 1.5...3.6V	0.0 V _{DD}		0.3 V _{DD}	V
Input leakage Current	I _{leak_25} I _{leak_85}	T = 25°C T = 85°C		0.01 0.25	0.14 1.40	µA
Input Capacitance	C _{IN}				6	pF

DIGITAL OUTPUTS (SDA)

Parameter	Symbol	Conditions	Min	Typ	Max	Unit
Output High Voltage	V_{OH}	$I_{Source} = 1\text{mA}$	$0.8 V_{DD}$		V_{DD}	V
Output Low Voltage	V_{OL}	$I_{Sink} = 1\text{mA}$	$0.0 V_{DD}$		$0.2 V_{DD}$	V

CONNECTION DIAGRAM

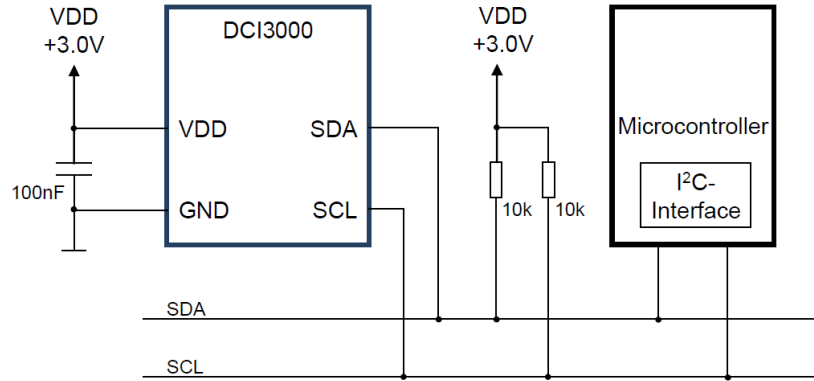

PIN FUNCTION TABLE

Pin	Name	Type	Function
1	VDD	Power	Supply Voltage
2	SCL	Digital Input	I ² C: Serial Data Clock
3	SDA	Digital Input/Output	I ² C Data Input / Output
4	VSS	Power	Ground
5 – 8	NC	---	Not connected / Do not connect

INTERFACE DESCRIPTION

I²C INTERFACE

An I²C communication message starts with a start condition and it is ended by a stop condition. Each command consists of two bytes: the address byte and command byte.

I²C ADDRESS

The I²C address is 0b1000000x.

COMMANDS

There are four commands:

- Reset
- Read PROM (serial number)
- Read ADC16 Temperature Data (with SCL hold)
- Read ADC16 Temperature Data (without SCL hold)

Command	Hex Value
Reset	0xFE
Read ADC16 Temperature Data (with SCL hold)	0xE3
Read ADC16 Temperature Data (without SCL hold)	0xF3
Read first 8 bytes of Serial Number	0xFA0F
Read last 6 bytes of Serial Number	0xFCC9

RESET SEQUENCE

The reset of TSYS02D can be sent at any time. When SDA line is blocked by an undefined state the only way to get the TSYS02D to work is to send a power on reset or several SCL cycles. This is not needed when the last command was not a conversion.

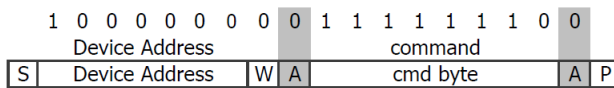

From Master
 SCL Slave Poll
 S = Start Condition W = Write A = Acknowledge
 From Slave P = Stop Condition R = Read N = Not Acknowledge

CONVERSION AND ADC READ

A conversion can be started by sending this command to TSYS02D. When the command is sent to the sensor it stays busy until conversion is done. All other commands except the reset command will not be executed during this time. When conversion is finished the data can be accessed by sending a Read command. If an acknowledge appears from the TSYS02D, you may then send 24 SCLK cycles to get all result bits. Every 9th bit the system waits for acknowledge. If the acknowledge is not sent the data clocking out of the chip stops. Two types of conversion commands for temperature reading are possible. If the “hold” command is issued, the SCL is held low during conversion, indicating when the conversion is finished. If the “no hold” is issued, the SCL line is not controlled by the TSYS02D.

WITH HOLD

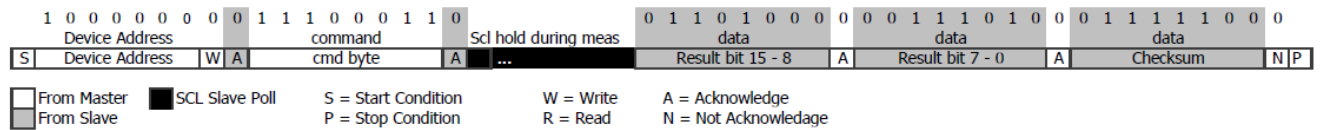

From Master
 SCL Slave Poll
 S = Start Condition W = Write A = Acknowledge
 From Slave P = Stop Condition R = Read N = Not Acknowledge

WITHOUT HOLD

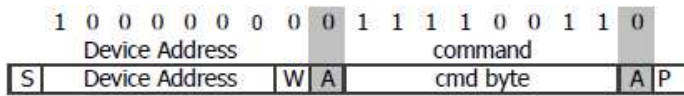

From Master SCL Slave Poll S = Start Condition W = Write A = Acknowledge
 From Slave P = Stop Condition R = Read N = Not Acknowledge

Poll if the conversion is finished by sending the address and check for acknowledge

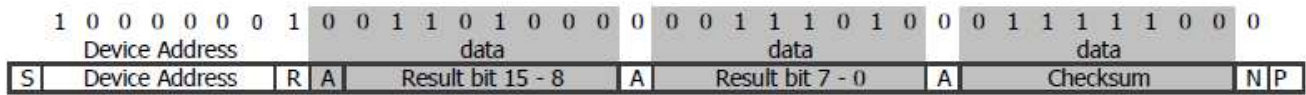

From Master SCL Slave Poll S = Start Condition W = Write A = Acknowledge
 From Slave P = Stop Condition R = Read N = Not Acknowledge

CHECKSUM

The TSYS02 provides a CRC-8 checksum for error detection. The polynomial used is $x^8 + x^5 + x^4 + 1$.

BASIC CONSIDERATIONS

CRC stands for Cyclic Redundancy Check. It is one of the most effective error detection schemes and requires a minimal amount of resources.

The types of errors that are detectable with CRC implemented in TSYS02 are:

- Any odd number of errors anywhere within the data transmission
- All double-bit errors anywhere within the transmission
- Any cluster of errors that can be contained within an 8-bit window (1-8 bits incorrect)
- Most larger clusters of errors

A CRC is an error-detecting code commonly used in digital networks and storage devices to detect accidental changes to raw data.

The TSYS02 uses an 8-bit CRC to detect transmission errors. The CRC covers all read data transmitted by the sensor. CRC properties are listed in the table below.

Generator polynomial	$x^8 + x^5 + x^4 + 1$
Initialization	0x00
Protected data	Read data
Final operation	None

CRC CALCULATION

To compute an n-bit binary CRC, line the bits representing the input in a row, and position the (n+1)-bit pattern representing the CRC's divisor (called a "polynomial") underneath the left-hand end of the row.

This is first padded with zeroes corresponding to the bit length n of the CRC.

If the input bit above the leftmost divisor bit is 0, do nothing. If the input bit above the leftmost divisor bit is 1, the divisor is XORed into the input (in other words, the input bit above each 1-bit in the divisor is toggled). The divisor is then shifted one bit to the right, and the process is repeated until the divisor reaches the right-hand end of the input row.

Since the left most divisor bit zeroed every input bit it touched, when this process ends the only bits in the input row that can be nonzero are the n bits at the right-hand end of the row. These n bits are the remainder of the division step, and will also be the value of the CRC function.

The validity of a received message can easily be verified by performing the above calculation again, this time with the check value added instead of zeroes. The remainder should equal zero if there are no detectable errors.

CRC EXAMPLES

The input message 01101000 00111010 (0x683A: 24.69°C) will have as result 01111100 (0x7C)

TEMPERATURE CALCULATION**TEMPERATURE POLYNOMIAL**

$$ADC16: \quad ADC \text{ Result } 16 \text{ bits}$$

$$T / ^\circ C = \quad ADC16 / 2^{16} \times 175.72 - 46.85$$

EXAMPLE

$$ADC16: \quad \underline{26682 (0x683A)}$$

$$T / ^\circ C = \quad 26682 / 2^{16} \times 175.72 - 46.85$$

$$T / ^\circ C = \quad \underline{24.69^\circ C}$$

DIMENSIONS**TOP VIEW**

TSYS02D

Digital Temperature Sensor

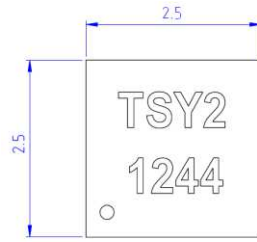

BOTTOM VIEW

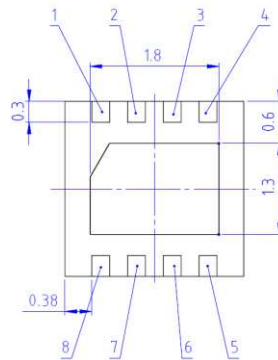

SIDE VIEW

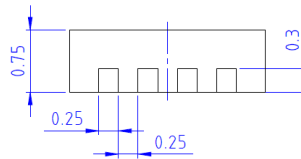

MARKING

Line	Description	Example
1	Product Name	TSY2
2	Pin 1 Dot, Date Code YYWW	1244

ORDER INFORMATION

The TSYS02 temperature sensor family comprises currently three different solutions. Further customer specific adaptations are available on request. Please refer to the table below for part name, description and order information.

Part Name	Description	Order Number
TSYS02D	Digital Temperature Sensor, TDFN8, I2C Interface	G-NIMO-003
TSYS02P	Digital Temperature Sensor, TDFN8, PWM Interface	G-NIMO-004
TSYS02S	Digital Temperature Sensor, TDFN8, SDM Interface	G-NIMO-005

EMC

Due to the use of these modules for OEM application no CE declaration is done. Especially line coupled disturbances like surge, burst, HF etc. cannot be removed by the module due to the small board area and low price feature. There is no protection circuit against reverse polarity or over voltage implemented. The module will be designed using capacitors for blocking and ground plane areas in order to prevent wireless coupled disturbances as good as possible.

DEFINITIONS AND DISCLAIMERS

- Application information – Applications that are described herein for any of these products are for illustrative purpose only. MEAS Deutschland GmbH makes no representation or warranty that such applications will be suitable for the specified use without further testing or modification.
- Life support applications – These products are not designed for use in life support appliances, devices, or systems where malfunctions of these products can reasonably be expected to result in personal injury. MEAS Deutschland GmbH customers using or selling this product for use in such applications do so at their own risk and agree to fully indemnify MEAS Deutschland GmbH for any damages resulting from such improper use or sale.

NORTH AMERICA

Measurement Specialties, Inc.,
a TE Connectivity Company
910 Turnpike Road
Shrewsbury, MA 01545
Tel: 1-508-842-0516
Fax: 1-508-842-0342
Sales email:
temperature.sales.amer@meas-spec.com

EUROPE

Measurement Specialties (Europe), Ltd.,
a TE Connectivity Company
Deutschland GmbH
Hauert 13
44277 Dortmund
Tel: +49 (0) 231/9740-0
Fax: +49 (0) 231/9740-20
Sales email:
info.de@meas-spec.com

ASIA

Measurement Specialties (China), Ltd.,
a TE Connectivity Company
No. 26 Langshan Road
Shenzhen High-Tech Park (North)
Nanshan District, Shenzhen 518057
China
Tel: +86 755 3330 5088
Fax: +86 755 3330 5099
Sales: temperature.sales.asia@meas-spec.com

TE.com/sensorsolutions

Measurement Specialties, Inc., a TE Connectivity company.

Measurement Specialties, TE Connectivity, TE Connectivity (logo) and EVERY CONNECTION COUNTS are trademarks. All other logos, products and/or company names referred to herein might be trademarks of their respective owners.

The information given herein, including drawings, illustrations and schematics which are intended for illustration purposes only, is believed to be reliable. However, TE Connectivity makes no warranties as to its accuracy or completeness and disclaims any liability in connection with its use. TE Connectivity's obligations shall only be as set forth in TE Connectivity's Standard Terms and Conditions of Sale for this product and in no case will TE Connectivity be liable for any incidental, indirect or consequential damages arising out of the sale, resale, use or misuse of the product. Users of TE Connectivity products should make their own evaluation to determine the suitability of each such product for the specific application.

© 2015 TE Connectivity Ltd. family of companies All Rights Reserved.