



ABSOLUTE MAXIMUM RATINGS

Parameters	Symbol	Unit	Value	Comment
Supply voltage	V _{cc}	V	7	
Primary conductor temperature	—	°C	110	
Non repetitive primary current pulse(20 μS), in powered or unpowered state.	I _p	A	20 × I _f	
ESD(HBM: Human Body Model)	—	kV	4	C=100pF, R=1.5k Ω

ISOLATION CHARACTERISTICS

Parameters	Symbol	Unit	Value	Comment
Insulation voltage	V _d	—	AC4300V, for 1minute(Sensing current 0.5mA)	Primary ↔ Secondary
Insulation Resistance	R _{is}	—	≥ 500M Ω (at DC500V)	Primary ↔ Secondary
Clearance distance	d _{ci}	—	8.2mm (TYP)	Primary ↔ Secondary
Creepage distance	d _{cp}	—	8.2mm (TYP)	Primary ↔ Secondary
Case material	—	—	UL94 V-0	
Comparative Tracking Index: (CTI)	CTI	V	600	
Application example	—	—	300V, CAT III, PD2	Reinforced isolation,non uniform field according to EN61010
	—	—	600V, CAT III, PD2	Reinforced isolation,non uniform field according to EN50178
	—	—	1000V, CAT III, PD2	Simple isolation,non uniform field according to EN50178

ENVIRONMENTAL AND MECHANICAL CHARACTERISTICS

Parameters	Symbol	Unit	Value			Comment
			MIN	TYP	MAX	
Ambient operating temperature	T _a	°C	-40		+105	
Ambient storage temperature	T _s	°C	-40		+105	
Mass	m	g		12		

SPECIFICATIONS

Ta=+25°C, RL=10kΩ, Vcc=+5V

Parameters	Symbol	Unit	Value			Comment		
			MIN	TYP	MAX			
Rated Current	F03P006S05	If	A		6			
	F03P015S05				15			
	F03P025S05				25			
	F03P050S05				50			
Maximum current	F03P006S05	I _{pmax}	A	-20		20		
	F03P015S05			-51		51		
	F03P025S05			-85		85		
	F03P050S05			-150		150		
Supply Voltage	V _{cc}	V		4.75	5.00	5.25		
Number of primary turns	N _p	T		1, 2, 3, 4				
Number of secondary turns	F03P006S05	N _s	T		1816			
	F03P015S05				1737			
	F03P025S05				1764			
	F03P050S05				1600			
Consumption current (at If)	F03P006S05	I _{cc}	mA		25	I _{cc} =15+I _p (mA)/N _s		
	F03P015S05				30			
	F03P025S05				35			
	F03P050S05				55			
Internal reference voltage(at I _p =0A)	V _{ref1}	V		2.495	2.500	2.505	Ref OUT mode	
External reference voltage	V _{ref2}	V		0		4	Ref IN mode	
Output voltage	V _o	V		0.375		4.625		
Output voltage(at I _p =0A)	V _o	V			V _{ref1} , V _{ref2}			
Electrical offset voltage	F03P006S05	V _{oe}	mV	-5.300		5.300		
	F03P015S05			-2.210		2.210		
	F03P025S05			-1.350		1.350		
	F03P050S05			-0.725		0.725		
Electrical offset current referred to primary	F03P006S05	I _{oe}	mA	-51		51		
	F03P015S05			-53		53		
	F03P025S05			-54		54		
	F03P050S05			-58		58		
Temperature coefficient of Internal reference voltage	TCV _{ref1}	ppm/K			±5.0	±50		
Temperature coefficient of Output voltage(at I _p =0A)	F03P006S05	TCV _o	ppm/K			±6.0	±14	ppm/K of 2.5V (-40°C~+105°C)
	F03P015S05					±2.3	±6	
	F03P025S05					±1.4	±4	
	F03P050S05					±0.7	±3	
Sensitivity(Theoretical value)	F03P006S05	G _{th}	mV/A		104.2		625mV/If	
	F03P015S05				41.67			
	F03P025S05				25			
	F03P050S05				12.5			
Sensitivity error	ε _G	%		-0.7		0.7		
Temperature coefficient of Sensitivity(at Ta=-40°C~+105°C)	TCG	ppm/K				±40		
Output Linearity(at If)	ε _L	%		-0.1		0.1		
Magnetic offset current referred to primary(at 10×If)	I _{oM}	A		-0.1		0.1		
Output current noise referred to primary(at 100Hz~100kHz)	I _{no}	μA/(Hz) ^{1/2}			20		RL=1kΩ	

Offset voltage value is after removal of core hysteresis.

SPECIFICATIONS

Ta=+25°C, RL=10kΩ, Vcc=+5V

Parameters	Symbol	Unit	Value			Comment
			MIN	TYP	MAX	
Peak to peak output ripple at oscillator frequency(f typ=450kHz)	F03P006S05	—		40	160	RL=1kΩ
	F03P015S05			15	60	
	F03P025S05			10	40	
	F03P050S05			5	20	
Reaction time(at 10% of If)	F03P006S05	tra			0.3	RL=1kΩ, di/dt=18A/μs
	F03P015S05				0.3	RL=1kΩ, di/dt=44A/μs
	F03P025S05				0.3	RL=1kΩ, di/dt=68A/μs
	F03P050S05				0.3	RL=1kΩ, di/dt=100A/μs
Response time 1 (at 90% of If)	F03P006S05	tr			0.3	RL=1kΩ, di/dt=18A/μs
	F03P015S05				0.3	RL=1kΩ, di/dt=44A/μs
	F03P025S05				0.3	RL=1kΩ, di/dt=68A/μs
	F03P050S05				0.3	RL=1kΩ, di/dt=100A/μs
Response time 2 (at 10% of If to 90% of Vo)		tr			0.6	RL=1kΩ, di/dt=If/μs
Frequency bandwidth(±1dB)		BW		200		RL=1kΩ
Frequency bandwidth(±3dB)		BW		300		RL=1kΩ
Output Voltage Accuracy(Overall)	F03P006S05	XG			1.7	$X_G=(100 \times V_{oe}/625)+\epsilon_G+\epsilon_L$
	F03P015S05				1.2	
	F03P025S05				1.0	
	F03P050S05				0.9	

STANDARDS

EN50178, EN61010-1, EN60950-1, UL508(file No.E243511)

※Please refer to the another sheet about conditions of UL Recognition.

Characteristic curve(TYP)

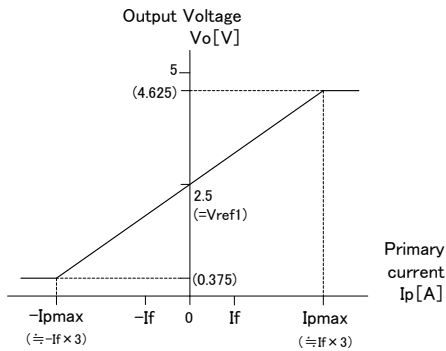

Figure 1 :Linearity curve (Internal reference voltage)

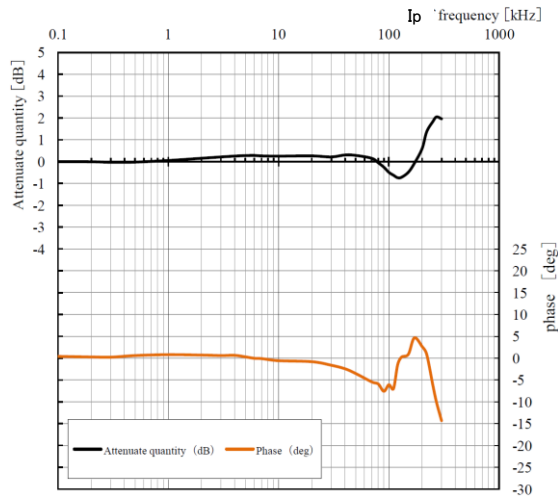

Figure 2: Frequency response curve

ex) F03P025S05
Measurement condition Ta=+25°C, RL=1kΩ, Ip=3A, Vcc=+5V

SUPPORT DOCUMENTATION

Maximum continuous DC primary current

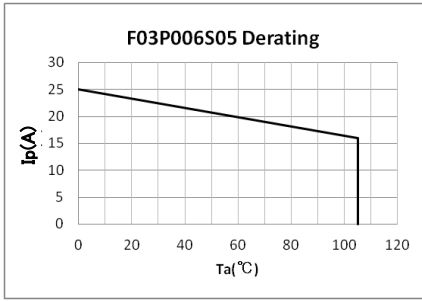

Figure 3 : Ip vs Ta for

F03P006S05

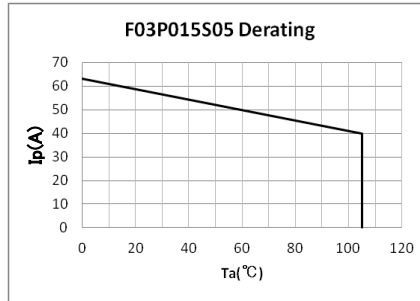

Figure 4 : Ip vs Ta for F03P015S05

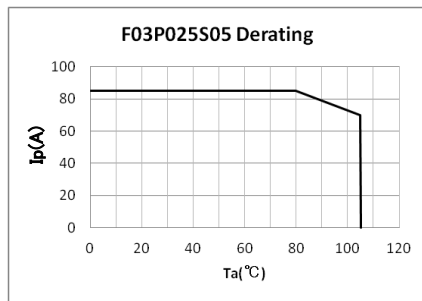

Figure 5 : Ip vs Ta for F03P025S05

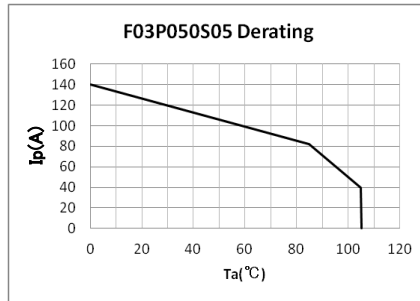

Figure 6 : Ip vs Ta for F03P050S05

According to which the following conditions are true the maximum continuous DC primary current plot shows the boundary of the area.

- ① $I_p < I_{pmax}$
- ② Junction temperature $T_j < 125^\circ\text{C}$
- ③ Primary conductor temperature $< 110^\circ\text{C}$
- ④ Resistor power dissipation $< 0.5 \times \text{rated power}$

Frequency derating

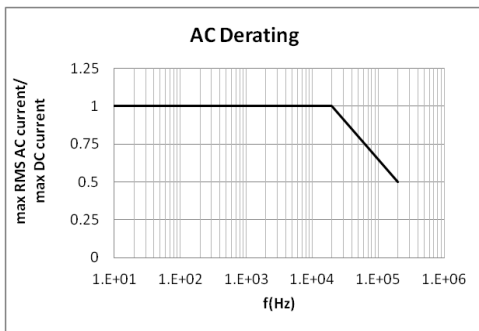

Figure 7 : Maximum RMS AC primary current/maximum DC primary current vs frequency

Reference voltage

The Ref pin has two modes Ref IN and Ref OUT:

<Ref OUT mode>

The 2.5V internal precision reference is used by the transducer as the reference point for bipolar measurements;

<Ref IN mode>

An external reference voltage is connected to the Ref pin; this voltage is specified in the range 0 to 4 V , its voltage is used as the reference voltage at the time of measurement.

- either to source a typical current of $(V_{ref}-2.5)/680$, the maximum value will be 2.2mA typ. when $V_{ref}=4V$.
- or to sink a typical current of $(2.5-V_{ref})/680$, the maximum value will be 3.68mA typ. when $V_{ref}=0V$.

The following graphs show how the measuring range of each transducer version depends on external reference voltage value V_{ref2} .

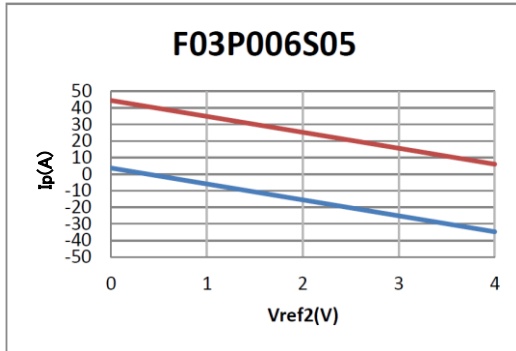

Upper limit: $I_p = -9.6 \times V_{ref2} + 44.4$ ($V_{ref2}=0...4V$)

Lower limit: $I_p = -9.6 \times V_{ref2} + 3.6$ ($V_{ref2}=0...4V$)

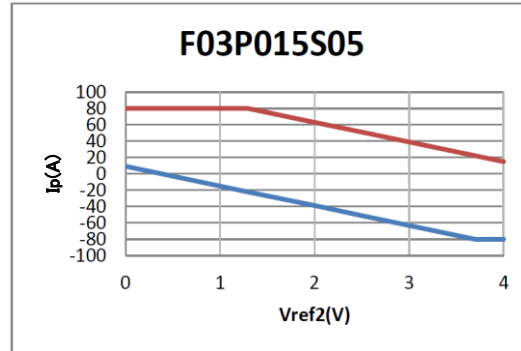

Upper limit: $I_p = 80$ ($V_{ref2}=0...1.29V$)

$I_p = -24 \times V_{ref2} + 111$ ($V_{ref2}=1.29...4V$)

Lower limit: $I_p = -24 \times V_{ref2} + 9$ ($V_{ref2}=0...3.7V$)

$I_p = -80$ ($V_{ref2}=3.7...4V$)

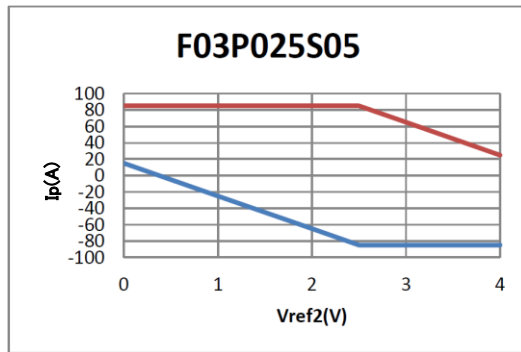

Upper limit: $I_p = 85$ ($V_{ref2}=0...2.5V$)

$I_p = -40 \times V_{ref2} + 185$ ($V_{ref2}=2.5...4V$)

Lower limit: $I_p = -40 \times V_{ref2} + 15$ ($V_{ref2}=0...2.5V$)

$I_p = -85$ ($V_{ref2}=2.5...4V$)

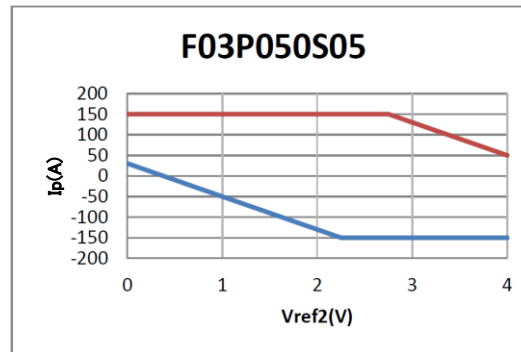

Upper limit: $I_p = 150$ ($V_{ref2}=0...2.75V$)

$I_p = -80 \times V_{ref2} + 370$ ($V_{ref2}=2.75...4V$)

Lower limit: $I_p = -80 \times V_{ref2} + 30$ ($V_{ref2}=0...2.25V$)

$I_p = -150$ ($V_{ref2}=2.25...4V$)

If you do not want to use the Ref pin, please unconnected.

CONNECTION

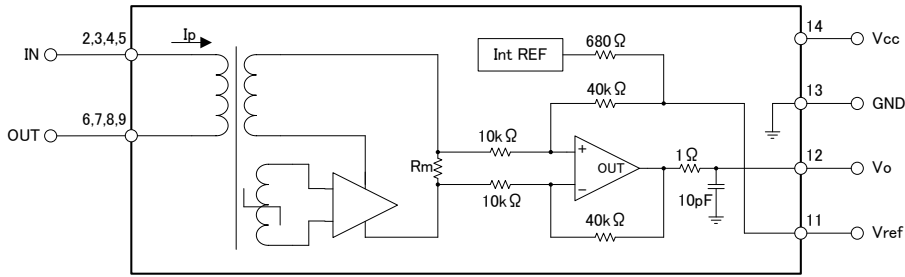

If/4	
If/2	
If	

DIMENSIONS(mm)

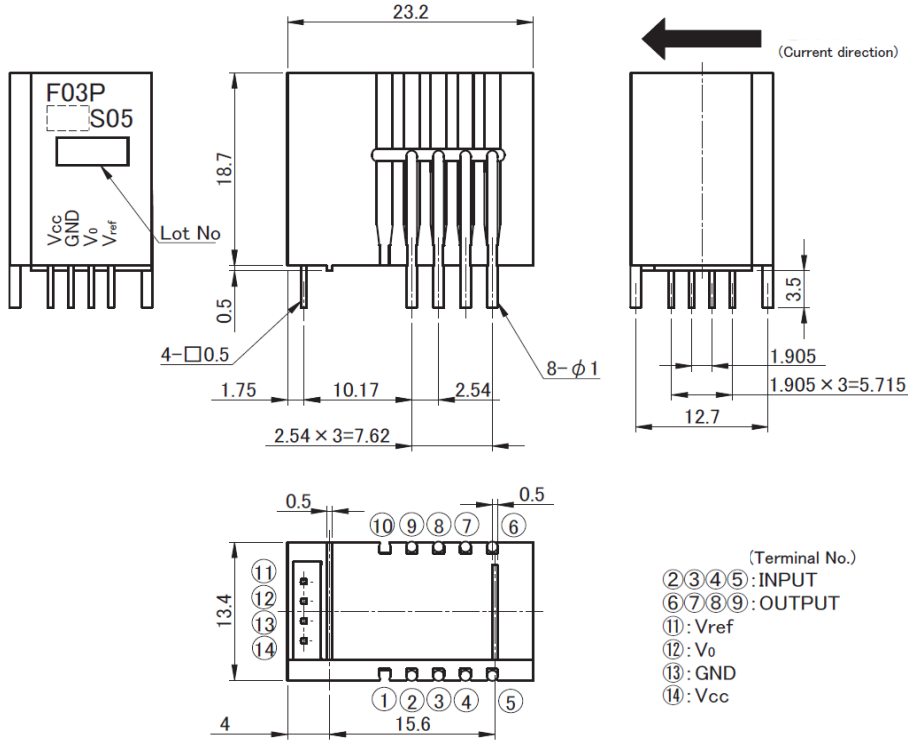

※: (Unless otherwise specified tolerances shall be ±0.5)

RECOMMENDED HOLE DIAMETER(mm)

