



QT-Brightek Lamp Series
5mm Round Deep Red LED
Part No.: QBL7SA60D

Product: QBL7SA60D	Date: January 22, 2018	Page 1 of 7
	Version# 1.0	



Table of Contents:

Introduction 3
Electrical / Optical Characteristic (Ta=25 °C) 4
Absolute Maximum Rating 4
Characteristic Curves..... 5
Ordering Information 6
Revision History 7
Disclaimer 7

Introduction

Feature:

- Color diffused lens
- Package in bulk pack
- 5mm round lamp
- AlGaAs technology
- Viewing angle: 60° typ.

Description:

These bright 3mm round type lamps are suitable for all indicator applications such as electronic signs and electronics board indicator

Application:

- General purpose indicator application
- Electronic signs and electronics board

Certification & Compliance:

- TS16949
- ISO9001
- RoHS Compliant



Dimension:

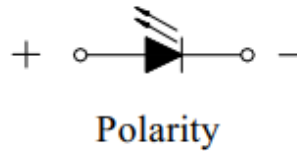
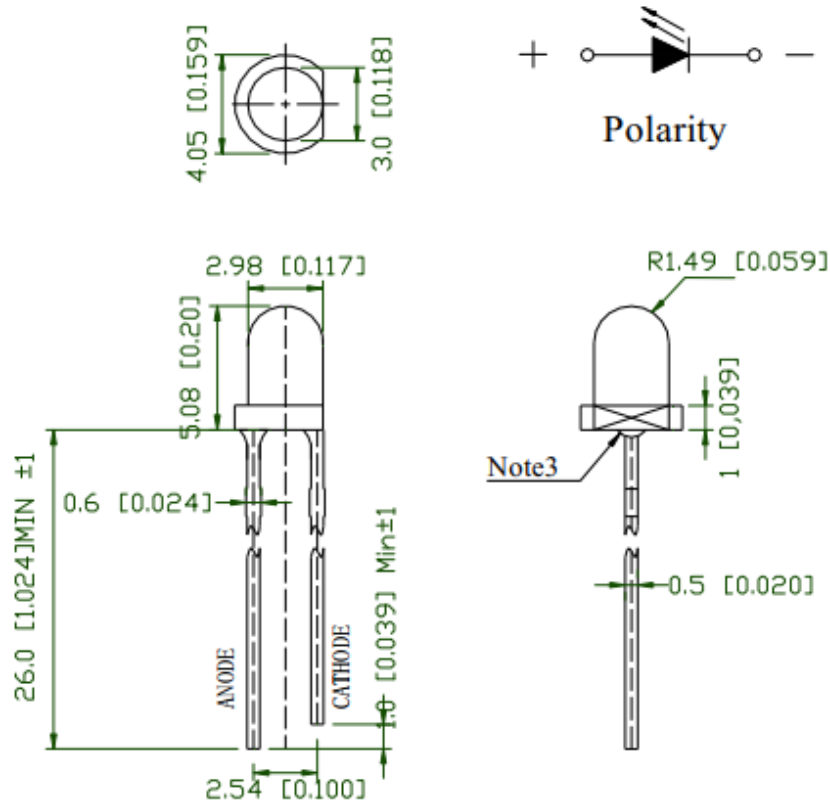

Units: mm / tolerance = +/-0.25mm unless otherwise specified



QBL7SA60D

3mm Round Lamp

Electrical / Optical Characteristic (Ta=25°C)

Product	Color	I _F (mA)	V _F (V)		λ _D (nm)	I _V (mcd)	
			Typ.	Max.	Typ.	Min.	Typ.
QBL7SA60D	Deep Red	20	1.8	2.4	640	20	45

Absolute Maximum Rating

Material	P _d (mW)	I _F (mA)	I _{FP} (mA)*	V _R (V)	T _{OP} (°C)	T _{ST} (°C)
AlGaAs	60	25	100	5	-40 ~ +85	-40 ~ +100

*1/10 Duty Cycle, 0.1ms Pulse Width

Characteristic Curves

AlGaAs

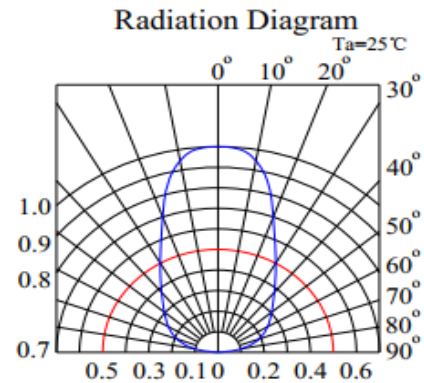
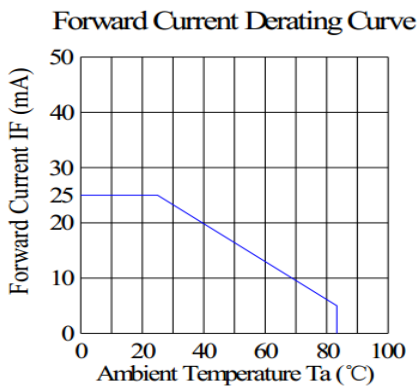
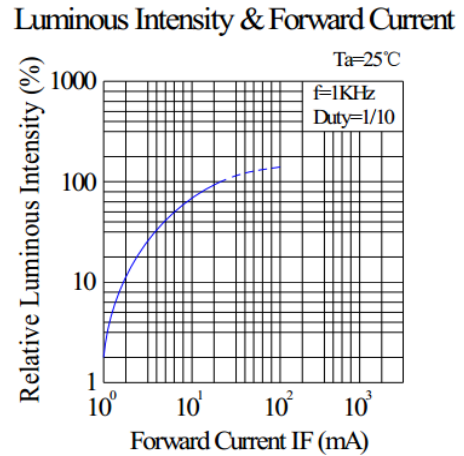
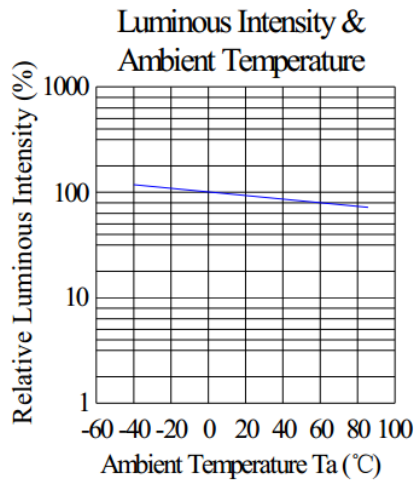
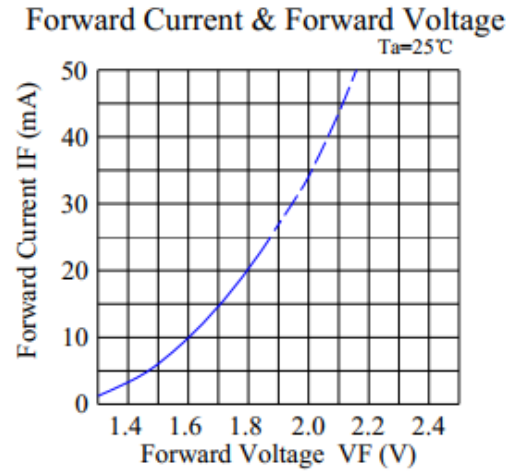
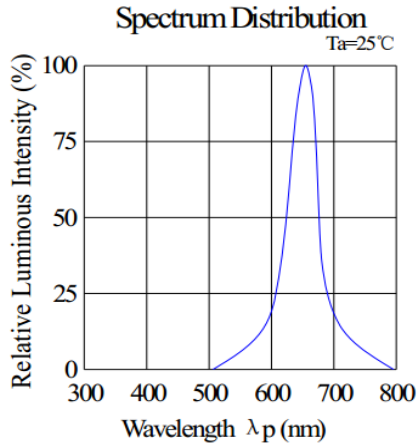



QBL7SA60D

3mm Round Lamp

Ordering Information

Part #	Orderable Part #	Spec Range	Quantity per bag
QBL7SA60D	QBL7SA60D	Iv=45mcd typ. @ 20mA, $\lambda_D=640\text{nm}$ typ.	500pcs



Revision History

Description:	Revision #	Revision Date
New Release of QBL7SA60D	V1.0	02/14/2018

Disclaimer

QT-BRIGHTTEK reserves the right to make changes without further notice to any products herein to improve reliability, function or design. QT-BRIGHTTEK does not assume any liability arising out of the application or use of any product or circuit described herein; neither does it convey any license under its patent rights, nor the rights of others.

Life Support Policy

QT-BRIGHTTEK's products are not authorized for use as critical components in life support devices or systems without the express written approval of QT-BRIGHTTEK. As used herein:

1. Life support devices or systems are devices or systems which, (a) are intended for surgical implant into the body, or (b) support or sustain life, and (c) whose failure to perform when properly used in accordance with instructions for use provided in the labeling, can be reasonably expected to result in a significant injury of the user.
2. A critical component in any component of a life support device or system whose failure to perform can be reasonably expected to cause the failure of the life support device or system, or to affect its safety or effectiveness.